

Subtitle C—Federal Property
Management Regulations
System

CHAPTER 101—FEDERAL PROPERTY MANAGEMENT REGULATIONS

SUBCHAPTER A—GENERAL

<i>Part</i>		<i>Page</i>
101-1	Introduction	7
101-3	Annual real property inventories	9
101-4	Nondiscrimination on the basis of sex in education programs or activities receiving Federal finan- cial assistance	13
101-5	Centralized services in Federal buildings and com- plexes	30
101-6	Miscellaneous regulations	39
101-8	Nondiscrimination in Federal financial assistance programs	73
101-9	Federal mail management	89

SUBCHAPTER B [RESERVED]

SUBCHAPTER C—DEFENSE MATERIALS

101-14—101-15 [Reserved]

SUBCHAPTER D—PUBLIC BUILDINGS AND SPACE

101-16	[Reserved]	
101-17	Assignment and utilization of space	96
101-18	Acquisition of real property	96
101-19	Construction and alteration of public buildings	109
101-20	Management of buildings and grounds	212
101-21	Federal Buildings Fund	233
APPENDIX TO SUBCHAPTER D—TEMPORARY REGULATIONS		234

SUBCHAPTER E—SUPPLY AND PROCUREMENT

101-25	General	237
101-26	Procurement sources and program	251
101-27	Inventory management	283
101-28	Storage and distribution	293
101-29	Federal product descriptions	298
101-30	Federal catalog system	304

41 CFR Ch. 101 (7-1-01 Edition)

101-31	Inspection and quality control	319
101-32	[Reserved]	
101-33	Public utilities	319
101-34	[Reserved]	
Appendix to Subchapter E—Temporary Regulations [Reserved]		
SUBCHAPTER F—MANAGEMENT AND USE OF TELECOMMUNICATIONS RESOURCES		
101-35	Telecommunications management policy	323
SUBCHAPTER G—AVIATION, TRANSPORTATION, AND MOTOR VEHICLES		
101-37	Government aviation administration and coordination	330
101-38	Motor vehicle management	352
101-39	Interagency fleet management systems	352
101-40	Transportation and traffic management	366
101-41	Transportation documentation and audit	366
Appendix to Subchapter G—Temporary Regulations [Reserved]		
SUBCHAPTER H—UTILIZATION AND DISPOSAL		
101-42	Utilization and disposal of hazardous materials and certain categories of property	367
101-43	Utilization of personal property	391
101-44	Donation of personal property	391
101-45	Sale, abandonment, or destruction of personal property	437
101-46	Replacement of personal property pursuant to the exchange/sale authority	478
101-47	Utilization and disposal of real property	482
101-48	Utilization, donation, or disposal of abandoned and forfeited personal property	556
101-49	Utilization, donation, and disposal of foreign gifts and decorations	567
APPENDIX TO SUBCHAPTER H—TEMPORARY REGULATIONS		

SUBCHAPTER A—GENERAL

PART 101-1—INTRODUCTION

Subpart 101-1.1—Regulation System

Sec.

- 101-1.100 Scope of subpart.
- 101-1.101 Federal Property Management Regulations System.
- 101-1.102 Federal Property Management Regulations.
- 101-1.103 FPMR temporary regulations.
- 101-1.104 Publication and distribution of FPMR.
 - 101-1.104-1 Publication.
 - 101-1.104-2 Distribution.
- 101-1.105 Authority for FPMR System.
- 101-1.106 Applicability of FPMR.
- 101-1.107 Agency consultation regarding FPMR.
- 101-1.108 Agency implementation and supplementation of FPMR.
- 101-1.109 Numbering in FPMR System.
- 101-1.110 Deviation.
- 101-1.111 Retention of FPMR amendments.
- 101-1.112 Change lines.

Subparts 101-1.2—101-1.48 [Reserved]

Subpart 101-1.49—Illustrations of Forms

- 101-1.4900 Scope of subpart.
- 101-1.4901 Standard forms. [Reserved]
- 101-1.4902 GSA forms.
- 101-1.4902-2053 GSA Form 2053, Agency Consolidated Requirements for GSA Regulations and Other External Issuances.

AUTHORITY: Sec. 205(c), 63 Stat. 390; 40 U.S.C. 486(c).

SOURCE: 29 FR 13255, Sept. 24, 1964, unless otherwise noted.

Subpart 101-1.1—Regulation System

§ 101-1.100 Scope of subpart.

This subpart sets forth introductory material concerning the Federal Property Management Regulations System: its content, types, publication, authority, applicability, numbering, deviation procedure, as well as agency consultation, implementation, and supplementation.

§ 101-1.101 Federal Property Management Regulations System.

The Federal Property Management Regulations System described in this subpart is established and shall be used

by General Services Administration (GSA) officials and, as provided in this subpart, by other executive agency officials, in prescribing regulations, policies, procedures, and delegations of authority pertaining to the management of property, and other programs and activities of the type administered by GSA, except procurement and contract matters contained in the Federal Acquisition Regulations (FAR).

[54 FR 37652, Sept. 12, 1989]

§ 101-1.102 Federal Property Management Regulations.

The Federal Property Management Regulations (FPMR) are regulations, as described by § 101-1.101, prescribed by the Administrator of General Services to govern and guide Federal agencies.

§ 101-1.103 FPMR temporary regulations.

(a) FPMR temporary regulations are authorized for publication when time or exceptional circumstances will not permit promulgation of an amendment to the Code of Federal Regulations and if the regulation will be effective for a period of 12 months or less except as provided in § 101-1.103(b), below. These temporary regulations will be codified before the designated expiration date or their effective date will be extended if it is determined that conversion to permanent form cannot be accomplished within the specified time frame.

(b) FPMR temporary regulations may have an effective period of up to 2 years when codification is not anticipated or is not considered practical.

[54 FR 37652, Sept. 12, 1989]

§ 101-1.104 Publication and distribution of FPMR.

§ 101-1.104-1 Publication.

FPMR will be published in the FEDERAL REGISTER, in looseleaf form, and in accumulated form in the Code of Federal Regulations. Temporary-type FPMR will be published in the Notices

§ 101-1.104-2

section of the FEDERAL REGISTER¹ and in looseleaf form.

[36 FR 4983, Mar. 16, 1971]

§ 101-1.104-2 Distribution.

(a) Each agency shall designate an official to serve as liaison with GSA on matters pertaining to the distribution of FPMR and other publications in the FPMR series. Agencies shall report all changes in designation of agency liaison officers to the General Services Administration (CAR), Washington, DC 20405.

(b) FPMR and other publications in the FPMR series will be distributed to agencies in bulk quantities for internal agency distribution in accordance with requirements information furnished by liaison officers. FPMR and other publications in the FPMR series will not be stocked by, and cannot be obtained from, GSA regional offices.

(c) Agencies shall submit their consolidated requirements for FPMR and other publications in the FPMR series, including requirements of field activities, and changes in such requirements on GSA Form 2053, Agency Consolidated Requirements for GSA Regulations and Other External Issuances (illustrated at § 101-1.4902-2053). The mailing address is shown on the form.

[36 FR 4983, Mar. 16, 1971, as amended at 53 FR 2739, Feb. 1, 1988]

§ 101-1.105 Authority for FPMR System.

The FPMR system is prescribed by the Administrator of General Services under authority of the Federal Property and Administrative Services Act of 1949, 63 Stat. 377, as amended, and other laws and authorities specifically cited in the text.

§ 101-1.106 Applicability of FPMR.

The FPMR apply to all Federal agencies to the extent specified in the Federal Property and Administrative Services Act of 1949 or other applicable law.

¹EDITORIAL NOTE: FPMR temporary regulations are published in the Rules and Regulations section of the FEDERAL REGISTER and, if in effect on the revision date of the Code of Federal Regulations volume, in the appendixes to the subchapters in 41 CFR chapter 101.

41 CFR Ch. 101 (7-1-01 Edition)

§ 101-1.107 Agency consultation regarding FPMR.

FPMR are developed and prescribed in consultation with affected Federal agencies.

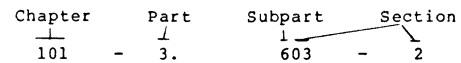
§ 101-1.108 Agency implementation and supplementation of FPMR.

Chapters 102 through 150 of this title are available for agency implementation and supplementation of FPMR contained in chapter 101 of this title. Supplementation pertains to agency regulations in the subject matter of FPMR but not yet issued in chapter 101.

[54 FR 37652, Sept. 12, 1989]

§ 101-1.109 Numbering in FPMR System.

(a) In the numbering system, all FPMR material is preceded by the digits 101-. This means that it is chapter 101 in title 41 of the Code of Federal Regulations. It has no other significance. The digit(s) before the decimal point indicates the part; the digits after the decimal point indicate, without separation, the subpart and section. For example:



(b) At the bottom of each page appears the number and date (month and year) of the FPMR amendment which transmitted it.

(c) Agency implementing regulations should conform to the FPMR section numbers, except for the substitution of the chapter designation of the agency. Agency supplementing regulations should be numbered "50" or higher for section, subpart, or part as may be involved.

[54 FR 37652, Sept. 12, 1989]

§ 101-1.110 Deviation.

(a) In the interest of establishing and maintaining uniformity to the greatest extent feasible, deviations; i.e., the use of any policy or procedure in any manner that is inconsistent with a policy or procedure prescribed in the Federal Property Management Regulations, are prohibited unless such deviations have been requested from the approved by

the Administrator of General Services or his authorized designee. Deviations may be authorized by the Administrator of General Services or his authorized designee when so doing will be in the best interest of the Government. Request for deviations shall clearly state the nature of the deviation and the reasons for such special action.

(b) Requests for deviations from the FPMR shall be sent to the General Services Administration for consideration in accordance with the following:

(1) For onetime (individual) deviations, requests shall be sent to the address provided in the applicable regulation. Lacking such direction, requests shall be sent to the Administrator of General Services, Washington, DC 20405.

(2) For class deviations, requests shall be sent to only the Administrator of General Services.

[54 FR 37652, Sept. 12, 1989]

§ 101-1.111 Retention of FPMR amendments.

Retention of FPMR amendments and removed pages will provide a history of FPMR issuances and facilitate determining which regulations were in effect at particular times.

[39 FR 40952, Nov. 22, 1974]

§ 101-1.112 Change lines.

(a) Single-column format: Vertical lines in the right margin of a page indicate material changed, deleted, or added by the FPMR amendment cited at the bottom of that page. Where insertion of new material results in shifting of unchanged material on following pages, no vertical lines will appear on such pages but the FPMR amendment transmitting such new pages will be cited at the bottom of each page.

(b) Double-column format: Arrows printed in the margin of a page indicated material changed, deleted, or added by the FPMR amendment cited at the bottom of that page.

[54 FR 37652, Sept. 12, 1989]

**Subparts 101-1.2—101-1.48
[Reserved]**

Subpart 101-1.49—Illustrations of Forms

§ 101-1.4900 Scope of subpart.

This subpart illustrates forms prescribed or available for use in connection with subject matter covered in other subparts of this part 101-1.

[36 FR 4983, Mar. 16, 1971]

§ 101-1.4901 Standard forms. [Reserved]

§ 101-1.4902 GSA forms.

(a) The GSA forms are illustrated in this section to show their text, format, and arrangement and to provide a ready source of reference. The subsection numbers in this section correspond with the GSA numbers.

(b) GSA forms illustrated in §101-1.4902 may be obtained by addressing requests to the General Services Administration, National Forms and Publications Center-7 CAR-W, Warehouse 4, Dock No. 1, 501 West Felix Street, Forth Worth, TX 76115.

[36 FR 4984, Mar. 16, 1971, as amended at 53 FR 2739, Feb. 1, 1988]

§ 101-1.4902-2053 GSA Form 2053, Agency Consolidated Requirements for GSA Regulations and Other External Issuances.

NOTE: The form listed in §101-1.4902-2053 is filed as part of the original document. Copies of the form may be obtained from the General Services Administration (3BRD), Washington, DC 20407.

[36 FR 4984, Mar. 16, 1971]

PART 101-3—ANNUAL REAL PROPERTY INVENTORIES

Sec.

101-3.000 Scope of part.

Subpart 101-3.1—General Provisions

101-3.100 Scope of subpart.

101-3.101 Background.

101-3.102 Program objectives.

101-3.103 Coverage.

101-3.104 Source of data.

101-3.105 Agency Liaison.

§ 101-3.000

41 CFR Ch. 101 (7-1-01 Edition)

Subpart 101-3.2—Annual Reports—Real Property Owned by and Leased to the United States

- 101-3.200 Scope of subpart.
- 101-3.201 Reporting agency.
- 101-3.202 Coverage.
- 101-3.203 Exclusions.
- 101-3.204 Reports to be submitted.
- 101-3.205 Optional reporting method.
- 101-3.206 Preparation and due dates.
- 101-3.207 Supplementary information.

Subparts 101-3.3—101-3.48 [Reserved]

Subpart 101-3.49—Forms and Reports

- 101-3.4900 Scope of subpart.
- 101-3.4901 GSA forms.
- 101-3.4901-1166 GSA Form 1166: Annual Report of Real Property Owned by or Leased to the United States.
- 101-3.4901-1166(I) Instructions for the preparation of GSA Form 1166: Annual Report of Real Property Owned or Leased to the United States.
- 101-3.4901-1166(I-A) Major cities.
- 101-3.4901-1209 GSA Form 1209: Summary of Number of Installations Owned by or Leased to the United States.
- 101-3.4901-1209(I) Instructions for the preparation of GSA Form 1209: Summary of Number of Installations Owned by or Leased to the United States.

AUTHORITY: Sec. 205(c), 63 Stat. 390 40 U.S.C. 486(c).

SOURCE: 29 FR 15596, Nov. 20, 1964, unless otherwise noted.

§ 101-3.000 Scope of part.

This part prescribes that procedures and forms for use by executive agencies in preparing annual reports necessary for the maintenance and publication of inventories of real property owned by and leased to the United States as of the last day of September of each fiscal year.

[54 FR 38673, Sept. 20, 1989]

Subpart 101-3.1—General Provisions

§ 101-3.100 Scope of subpart.

This subpart deals with the background, objectives, and coverage of reports in connection with the real property owned by and leased to the United States.

§ 101-3.101 Background.

(a) The inventory of Federal real property was initiated and is being continued at the request of the Senate Committee on Appropriations.

(b) The House Committee on Government Operations requests data annually on all federally owned real property for inclusion in its real and personal property inventory reports.

(c) Executive Order 12411 and related regulations require annual review of agency goals and plans in the area of space reduction and property disposals.

[29 FR 15596, Nov. 20, 1964, as amended at 54 FR 38673, Sept. 20, 1989]

§ 101-3.102 Program objectives.

The principal objectives of the Governmentwide real property inventory program are:

(a) To provide a centralized source of information on Federal real property holdings;

(b) To track space utilization of reporting agencies;

(c) To identify underutilized property;

(d) To achieve the most effective control and economical Governmentwide utilization of available property;

(e) To facilitate disposal of surplus property;

(f) To evaluate the compliance of reporting agencies with the provisions of Executive Order 12411 and implementing regulations;

(g) To provide a basis for the intelligent evaluation and appraisal of budgetary requirements; and

(h) To establish a ready reference for answering inquiries from the Congress, the press, trade associations, educational institutions, Federal, State and local government agencies, and the general public.

[54 FR 38673, Sept. 20, 1989]

§ 101-3.103 Coverage.

The inventory reports prescribed in this part 101-3 shall cover land, buildings, and other structures and facilities throughout the world, which are owned by or leased to the United States, including wholly-owned Federal Government corporations.

Federal Property Management Regulations

§ 101-3.202

§ 101-3.104 Source of data.

Data reported shall be based on agency real property and accounting records.

§ 101-3.105 Agency Liaison.

Each reporting agency shall designate an official to serve as agency representative for the real property inventories. The same representative should be designated for the federally owned and leased real property inventories, although separate representatives are permitted. The General Services Administration, Office of Governmentwide Policy, Washington, DC 20405, shall be advised in writing of the names of all such representatives and subsequent changes.

[54 FR 38674, Sept. 20, 1989]

Subpart 101-3.2—Annual Reports—Real Property Owned by and Leased to the United States

SOURCE: 54 FR 38674, Sept. 20, 1989, unless otherwise noted.

§ 101-3.200 Scope of subpart.

This subpart prescribes the procedures and forms to be used by executive agencies in connection with annual reports on real property owned by and leased to the United States.

§ 101-3.201 Reporting agency.

Reports on real property owned by and leased to the United States shall be submitted by the agency responsible for the maintenance of real property records and accounts as prescribed by General Accounting Office principles and standards and illustrated in 2 GAO 1270 and 2 GAO 7030 for owned property. For purposes of this inventory, the above rule shall apply regardless of the manner of acquisition or which agency is currently using the property. For example:

(a) For general purpose buildings, such as office buildings or warehouses, which are occupied by a Federal agency or agencies upon determination by GSA, and for which GSA is responsible for elevator and guard service, and for

cleaning and maintenance, GSA is the reporting agency.

(b) For special purpose buildings, such as Coast Guard stations, military reservations, hospitals, and prisons, those agencies having control of building management and operation including authority to assign or reassign space in such buildings, will be considered as the reporting agencies.

(c) For leased property, the agency currently administering the lease and making payments to the lessor, regardless of which agency executed the original lease or which agency is currently using the property.

§ 101-3.202 Coverage.

The annual reports of real property owned by or leased to the United States shall cover land, buildings, and other structures and facilities owned by the United States throughout the world and all real property leased from private individuals, organizations, and municipal, county, state, and foreign governments, as evidenced by a written agreement involving a monetary consideration and a landlord-tenant relationship. It shall also include right of use and occupancy obtained under eminent domain proceedings or equivalent procedures. These reports shall include the following:

- (a) Unreserved public domain lands.
- (b) Public domain lands reserved for national forests, national parks, military installations, or other purposes.
- (c) Real property acquired by purchase, construction, donation, and other methods.
- (d) Real property in which the Government has a long-term interest considered by the reporting agency as being equivalent to ownership.
- (e) Buildings or other structures and facilities owned by or leased to the Government whether or not located on Government-owned land.
- (f) Excess and surplus real property. (The reporting agency, as defined in § 101-3.201, shall continue to retain accountability and report excess and surplus real property pending its transfer to a Federal agency or disposal.)
- (g) Buildings being acquired under the terms of the Public Buildings Purchase Contract Program or Lease Purchase Agreements (39 U.S.C. 2103, 40

§ 101-3.203

41 CFR Ch. 101 (7-1-01 Edition)

U.S.C. 356). Buildings shall be reported upon completion of construction. Separate annual reports shall also be submitted for real properties held in trust by the Federal Government.

(h) Each lease executed for land only, with an annual rental of \$500 or more.

(i) Each lease executed for a building location(s), other structures and facilities, or combination thereof (whether or not land is included), with a total annual rental of \$2,000 or more.

(j) Real property leased rent free or for a nominal rental rate may be included when the property is considered significant by the reporting agency. 35 Comp. Gen. 713 is suggested as a guide to help resolve questions pertaining to the definition of nominal payment.

§ 101-3.203 Exclusions.

Annual inventory reports on real property owned by or leased to the United States shall not include the following:

(a) Properties acquired through foreclosure, confiscation, or seizure to be liquidated in settlement of a claim or debt to the Federal Government.

(b) Rights-of-way or easements granted to the Government.

(c) Lands administered by the United States under trusteeship by authority of the United Nations.

(d) Machinery and processing equipment which are not part of the realty.

(e) Real property occupied under permit or other arrangements with other Federal agencies or wholly owned Federal Government corporations.

(f) Leasehold improvements (Government-owned buildings or structures located on leased land shall be reported as owned); and

(g) Real Property leased rent free or for nominal rent when property is not considered significant by the reporting agency.

§ 101-3.204 Reports to be submitted.

(a) Each agency shall prepare in accordance with instructions in §101-3.4901-1166(I) and submit to GSA a separate report on GSA Form 1166, Annual Report of Real Property Owned by or Leased to the United States (see §101-3.4901-1166) for:

(1) Each newly acquired or previously omitted installation.

(2) Each installation received by transfer from another Federal agency which is not merged with an existing installation.

(3) Each installation with increases or decreases in cost of \$5,000 or more affecting any line item or the total for the installation.

(4) Each installation declared excess or surplus in whole or in part.

(5) Each disposal of a complete installation.

(6) Each installation for which a revision of an entry on a previous report is necessary to reflect a change in the name of an installation, date or method of acquisition of property, acreage, number and/or floor area of buildings, or predominant usage category of land, buildings, or other structures and facilities.

(7) Each new lease becoming effective during the reporting period.

(8) Each renewed lease citing the new expiration date.

(9) Change in annual rental rate.

(b) It is only necessary to report changes since the last reporting period and only identification data and affected line items need be reported. However, agencies reporting for the first time under these revised regulations must report their entire owned and leased inventories.

(c) Each agency shall prepare in accordance with instructions in §101-3.4901-1209(I) and submit to GSA a separate report on GSA Form 1209, Summary of Number of Installations Owned by or Leased to the United States (see §101-3.4901-1209) for each bureau or other major organizational unit, for owned and leased real property. Reports on GSA Form 1209 shall be submitted whether or not changes have occurred since the previous report.

§ 101-3.205 Optional reporting method.

Agencies with automated accounting systems may make arrangements with GSA, Office of Governmentwide Policy, to furnish detailed reports via magnetic tape input in lieu of GSA Form 1166. Each agency utilizing this method must obtain the automated reporting requirements from GSA, Office of Governmentwide Policy, before submitting any magnetic tape.

Federal Property Management Regulations

Pt. 101-4

§ 101-3.206 Preparation and due dates.

The annual inventory reports prescribed in §101-3.204 shall be prepared as of the last day of September of each fiscal year. An original and one copy of each report shall be submitted to the General Services Administration, Office of Governmentwide Policy, Washington, DC 20405, no later than 45 days after the report date.

§ 101-3.207 Supplementary information.

This reporting system has been cleared in accordance with FIRMR 201-45.6 and assigned interagency report control number 0315-GSA-AN. This interagency report control number replaces 1119-GSA-AN, 1120-GSA-AN, 1540-GSA-AN and 1541-GSA-AN.

Subparts 101-3.3—101-3.48 [Reserved]

Subpart 101-3.49—Forms and Reports

NOTE: GSA forms filed with the Office of the Federal Register as part of the original document. Copies may be obtained from Central Office, GSA.

§ 101-3.4900 Scope of subpart.

This subpart contains illustrations of forms and instructions for their completion, to be used by executive agencies in connection with the submission of annual reports of real property owned by and leased to the United States.

§ 101-3.4901 GSA forms.

The GSA forms referenced in this part may be obtained initially from the GSA National Forms and Publications Center, Box 17550, 819 Taylor Street, Fort Worth, TX 76102-0550. Agency field or regional offices should submit future requirements to their Washington, DC, headquarters office which will forward consolidated annual requirements to the General Services Administration, ATTN: 7BR, Fort Worth, TX 76102. The section numbers in this subpart correspond to the GSA form numbers and related instruction for their preparation. Thus in §101-3.4901-1166(I) appears

instructions for the preparation of GSA Form 1166.

[54 FR 38675, Sept. 20, 1989]

§ 101-3.4901-1166 GSA Form 1166: Annual Report of Real Property Owned by or Leased to the United States.

§ 101-3.4901-1166(I) Instructions for the preparation of GSA Form 1166: Annual Report of Real Property Owned or Leased to the United States.

§ 101-3.4901-1166(I-A) Major cities.

§ 101-3.4901-1209 GSA Form 1209: Summary of Number of Installations Owned by or Leased to the United States.

§ 101-3.4901-1209(I) Instructions for the preparation of GSA Form 1209: Summary of Number of Installations Owned by or Leased to the United States.

PART 101-4—NONDISCRIMINATION ON THE BASIS OF SEX IN EDUCATION PROGRAMS OR ACTIVITIES RECEIVING FEDERAL FINANCIAL ASSISTANCE

Subpart A—Introduction

Sec.

- 101-4.100 Purpose and effective date.
- 101-4.105 Definitions.
- 101-4.110 Remedial and affirmative action and self-evaluation.
- 101-4.115 Assurance required.
- 101-4.120 Transfers of property.
- 101-4.125 Effect of other requirements.
- 101-4.130 Effect of employment opportunities.
- 101-4.135 Designation of responsible employee and adoption of grievance procedures.
- 101-4.140 Dissemination of policy.

Subpart B—Coverage

- 101-4.200 Application.
- 101-4.205 Educational institutions and other entities controlled by religious organizations.
- 101-4.210 Military and merchant marine educational institutions.
- 101-4.215 Membership practices of certain organizations.
- 101-4.220 Admissions.
- 101-4.225 Educational institutions eligible to submit transition plans.
- 101-4.230 Transition plans.

§ 101-4.100

41 CFR Ch. 101 (7-1-01 Edition)

101-4.235 Statutory amendments.

Subpart C—Discrimination on the Basis of Sex in Admission and Recruitment Prohibited

101-4.300 Admission.
101-4.305 Preference in admission.
101-4.310 Recruitment.

Subpart D—Discrimination on the Basis of Sex in Education Programs or Activities Prohibited

101-4.400 Education programs or activities.
101-4.405 Housing.
101-4.410 Comparable facilities.
101-4.415 Access to course offerings.
101-4.420 Access to schools operated by LEAs.
101-4.425 Counseling and use of appraisal and counseling materials.
101-4.430 Financial assistance.
101-4.435 Employment assistance to students.
101-4.440 Health and insurance benefits and services.
101-4.445 Marital or parental status.
101-4.450 Athletics.
101-4.455 Textbooks and curricular material.

Subpart E—Discrimination on the Basis of Sex in Employment in Education Programs or Activities Prohibited

101-4.500 Employment.
101-4.505 Employment criteria.
101-4.510 Recruitment.
101-4.515 Compensation.
101-4.520 Job classification and structure.
101-4.525 Fringe benefits.
101-4.530 Marital or parental status.
101-4.535 Effect of state or local law or other requirements.
101-4.540 Advertising.
101-4.545 Pre-employment inquiries.
101-4.550 Sex as a bona fide occupational qualification.

Subpart F—Procedures

101-4.600 Notice of covered programs.
101-4.605 Enforcement procedures.

AUTHORITY: 20 U.S.C. 1681, 1682, 1683, 1685, 1686, 1687, 1688.

SOURCE: 65 FR 52865, 52891, Aug. 30, 2000, unless otherwise noted.

Subpart A—Introduction

§ 101-4.100 Purpose and effective date.

The purpose of these Title IX regulations is to effectuate Title IX of the Education Amendments of 1972, as

amended (except sections 904 and 906 of those Amendments) (20 U.S.C. 1681, 1682, 1683, 1685, 1686, 1687, 1688), which is designed to eliminate (with certain exceptions) discrimination on the basis of sex in any education program or activity receiving Federal financial assistance, whether or not such program or activity is offered or sponsored by an educational institution as defined in these Title IX regulations. The effective date of these Title IX regulations shall be September 29, 2000.

§ 101-4.105 Definitions.

As used in these Title IX regulations, the term:

Administratively separate unit means a school, department, or college of an educational institution (other than a local educational agency) admission to which is independent of admission to any other component of such institution.

Admission means selection for part-time, full-time, special, associate, transfer, exchange, or any other enrollment, membership, or matriculation in or at an education program or activity operated by a recipient.

Applicant means one who submits an application, request, or plan required to be approved by an official of the Federal agency that awards Federal financial assistance, or by a recipient, as a condition to becoming a recipient.

Designated agency official means the Associate Administrator for Civil Rights.

Educational institution means a local educational agency (LEA) as defined by 20 U.S.C. 8801(18), a preschool, a private elementary or secondary school, or an applicant or recipient that is an institution of graduate higher education, an institution of undergraduate higher education, an institution of professional education, or an institution of vocational education, as defined in this section.

Federal financial assistance means any of the following, when authorized or extended under a law administered by the Federal agency that awards such assistance:

(1) A grant or loan of Federal financial assistance, including funds made available for:

Federal Property Management Regulations

§ 101-4.105

(i) The acquisition, construction, renovation, restoration, or repair of a building or facility or any portion thereof; and

(ii) Scholarships, loans, grants, wages, or other funds extended to any entity for payment to or on behalf of students admitted to that entity, or extended directly to such students for payment to that entity.

(2) A grant of Federal real or personal property or any interest therein, including surplus property, and the proceeds of the sale or transfer of such property, if the Federal share of the fair market value of the property is not, upon such sale or transfer, properly accounted for to the Federal Government.

(3) Provision of the services of Federal personnel.

(4) Sale or lease of Federal property or any interest therein at nominal consideration, or at consideration reduced for the purpose of assisting the recipient or in recognition of public interest to be served thereby, or permission to use Federal property or any interest therein without consideration.

(5) Any other contract, agreement, or arrangement that has as one of its purposes the provision of assistance to any education program or activity, except a contract of insurance or guaranty.

Institution of graduate higher education means an institution that:

(1) Offers academic study beyond the bachelor of arts or bachelor of science degree, whether or not leading to a certificate of any higher degree in the liberal arts and sciences;

(2) Awards any degree in a professional field beyond the first professional degree (regardless of whether the first professional degree in such field is awarded by an institution of undergraduate higher education or professional education); or

(3) Awards no degree and offers no further academic study, but operates ordinarily for the purpose of facilitating research by persons who have received the highest graduate degree in any field of study.

Institution of professional education means an institution (except any institution of undergraduate higher education) that offers a program of academic study that leads to a first profes-

sional degree in a field for which there is a national specialized accrediting agency recognized by the Secretary of Education.

Institution of undergraduate higher education means:

(1) An institution offering at least two but less than four years of college-level study beyond the high school level, leading to a diploma or an associate degree, or wholly or principally creditable toward a baccalaureate degree; or

(2) An institution offering academic study leading to a baccalaureate degree; or

(3) An agency or body that certifies credentials or offers degrees, but that may or may not offer academic study.

Institution of vocational education means a school or institution (except an institution of professional or graduate or undergraduate higher education) that has as its primary purpose preparation of students to pursue a technical, skilled, or semiskilled occupation or trade, or to pursue study in a technical field, whether or not the school or institution offers certificates, diplomas, or degrees and whether or not it offers full-time study.

Recipient means any State or political subdivision thereof, or any instrumentality of a State or political subdivision thereof, any public or private agency, institution, or organization, or other entity, or any person, to whom Federal financial assistance is extended directly or through another recipient and that operates an education program or activity that receives such assistance, including any subunit, successor, assignee, or transferee thereof.

Student means a person who has gained admission.

Title IX means Title IX of the Education Amendments of 1972, Public Law 92-318, 86 Stat. 235, 373 (codified as amended at 20 U.S.C. 1681-1688) (except sections 904 and 906 thereof), as amended by section 3 of Public Law 93-568, 88 Stat. 1855, by section 412 of the Education Amendments of 1976, Public Law 94-482, 90 Stat. 2234, and by Section 3 of Public Law 100-259, 102 Stat. 28, 28-29 (20 U.S.C. 1681, 1682, 1683, 1685, 1686, 1687, 1688).

§ 101-4.110

Title IX regulations means the provisions set forth at §§ 101-4.100 through 101-4.605.

Transition plan means a plan subject to the approval of the Secretary of Education pursuant to section 901(a)(2) of the Education Amendments of 1972, 20 U.S.C. 1681(a)(2), under which an educational institution operates in making the transition from being an educational institution that admits only students of one sex to being one that admits students of both sexes without discrimination.

§ 101-4.110 Remedial and affirmative action and self-evaluation.

(a) *Remedial action.* If the designated agency official finds that a recipient has discriminated against persons on the basis of sex in an education program or activity, such recipient shall take such remedial action as the designated agency official deems necessary to overcome the effects of such discrimination.

(b) *Affirmative action.* In the absence of a finding of discrimination on the basis of sex in an education program or activity, a recipient may take affirmative action consistent with law to overcome the effects of conditions that resulted in limited participation therein by persons of a particular sex. Nothing in these Title IX regulations shall be interpreted to alter any affirmative action obligations that a recipient may have under Executive Order 11246, 3 CFR, 1964-1965 Comp., p. 339; as amended by Executive Order 11375, 3 CFR, 1966-1970 Comp., p. 684; as amended by Executive Order 11478, 3 CFR, 1966-1970 Comp., p. 803; as amended by Executive Order 12086, 3 CFR, 1978 Comp., p. 230; as amended by Executive Order 12107, 3 CFR, 1978 Comp., p. 264.

(c) *Self-evaluation.* Each recipient education institution shall, within one year of September 29, 2000:

(1) Evaluate, in terms of the requirements of these Title IX regulations, its current policies and practices and the effects thereof concerning admission of students, treatment of students, and employment of both academic and non-academic personnel working in connection with the recipient's education program or activity;

41 CFR Ch. 101 (7-1-01 Edition)

(2) Modify any of these policies and practices that do not or may not meet the requirements of these Title IX regulations; and

(3) Take appropriate remedial steps to eliminate the effects of any discrimination that resulted or may have resulted from adherence to these policies and practices.

(d) *Availability of self-evaluation and related materials.* Recipients shall maintain on file for at least three years following completion of the evaluation required under paragraph (c) of this section, and shall provide to the designated agency official upon request, a description of any modifications made pursuant to paragraph (c)(2) of this section and of any remedial steps taken pursuant to paragraph (c)(3) of this section.

§ 101-4.115 Assurance required.

(a) *General.* Either at the application stage or the award stage, Federal agencies must ensure that applications for Federal financial assistance or awards of Federal financial assistance contain, be accompanied by, or be covered by a specifically identified assurance from the applicant or recipient, satisfactory to the designated agency official, that each education program or activity operated by the applicant or recipient and to which these Title IX regulations apply will be operated in compliance with these Title IX regulations. An assurance of compliance with these Title IX regulations shall not be satisfactory to the designated agency official if the applicant or recipient to whom such assurance applies fails to commit itself to take whatever remedial action is necessary in accordance with § 101-4.110(a) to eliminate existing discrimination on the basis of sex or to eliminate the effects of past discrimination whether occurring prior to or subsequent to the submission to the designated agency official of such assurance.

(b) *Duration of obligation.* (1) In the case of Federal financial assistance extended to provide real property or structures thereon, such assurance shall obligate the recipient or, in the case of a subsequent transfer, the transferee, for the period during which the real property or structures are used

Federal Property Management Regulations

§ 101-4.135

to provide an education program or activity.

(2) In the case of Federal financial assistance extended to provide personal property, such assurance shall obligate the recipient for the period during which it retains ownership or possession of the property.

(3) In all other cases such assurance shall obligate the recipient for the period during which Federal financial assistance is extended.

(c) *Form.* (1) The assurances required by paragraph (a) of this section, which may be included as part of a document that addresses other assurances or obligations, shall include that the applicant or recipient will comply with all applicable Federal statutes relating to nondiscrimination. These include but are not limited to: Title IX of the Education Amendments of 1972, as amended (20 U.S.C. 1681-1683, 1685-1688).

(2) The designated agency official will specify the extent to which such assurances will be required of the applicant's or recipient's subgrantees, contractors, subcontractors, transferees, or successors in interest.

§ 101-4.120 Transfers of property.

If a recipient sells or otherwise transfers property financed in whole or in part with Federal financial assistance to a transferee that operates any education program or activity, and the Federal share of the fair market value of the property is not upon such sale or transfer properly accounted for to the Federal Government, both the transferor and the transferee shall be deemed to be recipients, subject to the provisions of §§ 101-4.205 through 101-4.235(a).

§ 101-4.125 Effect of other requirements.

(a) *Effect of other Federal provisions.* The obligations imposed by these Title IX regulations are independent of, and do not alter, obligations not to discriminate on the basis of sex imposed by Executive Order 11246, 3 CFR, 1964-1965 Comp., p. 339; as amended by Executive Order 11375, 3 CFR, 1966-1970 Comp., p. 684; as amended by Executive Order 11478, 3 CFR, 1966-1970 Comp., p. 803; as amended by Executive Order 12087, 3 CFR, 1978 Comp., p. 230; as

amended by Executive Order 12107, 3 CFR, 1978 Comp., p. 264; sections 704 and 855 of the Public Health Service Act (42 U.S.C. 295m, 298b-2); Title VII of the Civil Rights Act of 1964 (42 U.S.C. 2000e *et seq.*); the Equal Pay Act of 1963 (29 U.S.C. 206); and any other Act of Congress or Federal regulation.

(b) *Effect of State or local law or other requirements.* The obligation to comply with these Title IX regulations is not obviated or alleviated by any State or local law or other requirement that would render any applicant or student ineligible, or limit the eligibility of any applicant or student, on the basis of sex, to practice any occupation or profession.

(c) *Effect of rules or regulations of private organizations.* The obligation to comply with these Title IX regulations is not obviated or alleviated by any rule or regulation of any organization, club, athletic or other league, or association that would render any applicant or student ineligible to participate or limit the eligibility or participation of any applicant or student, on the basis of sex, in any education program or activity operated by a recipient and that receives Federal financial assistance.

§ 101-4.130 Effect of employment opportunities.

The obligation to comply with these Title IX regulations is not obviated or alleviated because employment opportunities in any occupation or profession are or may be more limited for members of one sex than for members of the other sex.

§ 101-4.135 Designation of responsible employee and adoption of grievance procedures.

(a) *Designation of responsible employee.* Each recipient shall designate at least one employee to coordinate its efforts to comply with and carry out its responsibilities under these Title IX regulations, including any investigation of any complaint communicated to such recipient alleging its noncompliance with these Title IX regulations or alleging any actions that would be prohibited by these Title IX regulations.

§ 101-4.140

The recipient shall notify all its students and employees of the name, office address, and telephone number of the employee or employees appointed pursuant to this paragraph.

(b) *Complaint procedure of recipient.* A recipient shall adopt and publish grievance procedures providing for prompt and equitable resolution of student and employee complaints alleging any action that would be prohibited by these Title IX regulations.

§ 101-4.140 Dissemination of policy.

(a) *Notification of policy.* (1) Each recipient shall implement specific and continuing steps to notify applicants for admission and employment, students and parents of elementary and secondary school students, employees, sources of referral of applicants for admission and employment, and all unions or professional organizations holding collective bargaining or professional agreements with the recipient, that it does not discriminate on the basis of sex in the educational programs or activities that it operates, and that it is required by Title IX and these Title IX regulations not to discriminate in such a manner. Such notification shall contain such information, and be made in such manner, as the designated agency official finds necessary to apprise such persons of the protections against discrimination assured them by Title IX and these Title IX regulations, but shall state at least that the requirement not to discriminate in education programs or activities extends to employment therein, and to admission thereto unless §§ 101-4.300 through 101-4.310 do not apply to the recipient, and that inquiries concerning the application of Title IX and these Title IX regulations to such recipient may be referred to the employee designated pursuant to § 101-4.135, or to the designated agency official.

(2) Each recipient shall make the initial notification required by paragraph (a)(1) of this section within 90 days of September 29, 2000 or of the date these Title IX regulations first apply to such recipient, whichever comes later, which notification shall include publication in:

41 CFR Ch. 101 (7-1-01 Edition)

(i) Newspapers and magazines operated by such recipient or by student, alumnae, or alumni groups for or in connection with such recipient; and

(ii) Memoranda or other written communications distributed to every student and employee of such recipient.

(b) *Publications.* (1) Each recipient shall prominently include a statement of the policy described in paragraph (a) of this section in each announcement, bulletin, catalog, or application form that it makes available to any person of a type, described in paragraph (a) of this section, or which is otherwise used in connection with the recruitment of students or employees.

(2) A recipient shall not use or distribute a publication of the type described in paragraph (b)(1) of this section that suggests, by text or illustration, that such recipient treats applicants, students, or employees differently on the basis of sex except as such treatment is permitted by these Title IX regulations.

(c) *Distribution.* Each recipient shall distribute without discrimination on the basis of sex each publication described in paragraph (b)(1) of this section, and shall apprise each of its admission and employment recruitment representatives of the policy of non-discrimination described in paragraph (a) of this section, and shall require such representatives to adhere to such policy.

Subpart B—Coverage

§ 101-4.200 Application.

Except as provided in §§ 101-4.205 through 101-4.235(a), these Title IX regulations apply to every recipient and to each education program or activity operated by such recipient that receives Federal financial assistance.

§ 101-4.205 Educational institutions and other entities controlled by religious organizations.

(a) *Exemption.* These Title IX regulations do not apply to any operation of an educational institution or other entity that is controlled by a religious organization to the extent that application of these Title IX regulations would not be consistent with the religious tenets of such organization.

Federal Property Management Regulations

§ 101-4.230

(b) *Exemption claims.* An educational institution or other entity that wishes to claim the exemption set forth in paragraph (a) of this section shall do so by submitting in writing to the designated agency official a statement by the highest-ranking official of the institution, identifying the provisions of these Title IX regulations that conflict with a specific tenet of the religious organization.

§ 101-4.210 Military and merchant marine educational institutions.

These Title IX regulations do not apply to an educational institution whose primary purpose is the training of individuals for a military service of the United States or for the merchant marine.

§ 101-4.215 Membership practices of certain organizations.

(a) *Social fraternities and sororities.* These Title IX regulations do not apply to the membership practices of social fraternities and sororities that are exempt from taxation under section 501(a) of the Internal Revenue Code of 1954, 26 U.S.C. 501(a), the active membership of which consists primarily of students in attendance at institutions of higher education.

(b) *YMCA, YWCA, Girl Scouts, Boy Scouts, and Camp Fire Girls.* These Title IX regulations do not apply to the membership practices of the Young Men's Christian Association (YMCA), the Young Women's Christian Association (YWCA), the Girl Scouts, the Boy Scouts, and Camp Fire Girls.

(c) *Voluntary youth service organizations.* These Title IX regulations do not apply to the membership practices of a voluntary youth service organization that is exempt from taxation under section 501(a) of the Internal Revenue Code of 1954, 26 U.S.C. 501(a), and the membership of which has been traditionally limited to members of one sex and principally to persons of less than nineteen years of age.

§ 101-4.220 Admissions.

(a) Admissions to educational institutions prior to June 24, 1973, are not covered by these Title IX regulations.

(b) *Administratively separate units.* For the purposes only of this section, §§ 101-

4.225 and 101-4.230, and §§ 101-4.300 through 101-4.310, each administratively separate unit shall be deemed to be an educational institution.

(c) *Application of §§ 101-4.300 through 101-4.310.* Except as provided in paragraphs (d) and (e) of this section, §§ 101-4.300 through 101-4.310 apply to each recipient. A recipient to which §§ 101-4.300 through 101-4.310 apply shall not discriminate on the basis of sex in admission or recruitment in violation of §§ 101-4.300 through 101-4.310.

(d) *Educational institutions.* Except as provided in paragraph (e) of this section as to recipients that are educational institutions, §§ 101-4.300 through 101-4.310 apply only to institutions of vocational education, professional education, graduate higher education, and public institutions of undergraduate higher education.

(e) *Public institutions of undergraduate higher education.* §§ 101-4.300 through 101-4.310 do not apply to any public institution of undergraduate higher education that traditionally and continually from its establishment has had a policy of admitting students of only one sex.

§ 101-4.225 Educational institutions eligible to submit transition plans.

(a) *Application.* This section applies to each educational institution to which §§ 101-4.300 through 101-4.310 apply that:

(1) Admitted students of only one sex as regular students as of June 23, 1972; or

(2) Admitted students of only one sex as regular students as of June 23, 1965, but thereafter admitted, as regular students, students of the sex not admitted prior to June 23, 1965.

(b) *Provision for transition plans.* An educational institution to which this section applies shall not discriminate on the basis of sex in admission or recruitment in violation of §§ 101-4.300 through 101-4.310.

§ 101-4.230 Transition plans.

(a) *Submission of plans.* An institution to which § 101-4.225 applies and that is composed of more than one administratively separate unit may submit either a single transition plan applicable to

§ 101-4.235

all such units, or a separate transition plan applicable to each such unit.

(b) *Content of plans.* In order to be approved by the Secretary of Education, a transition plan shall:

(1) State the name, address, and Federal Interagency Committee on Education Code of the educational institution submitting such plan, the administratively separate units to which the plan is applicable, and the name, address, and telephone number of the person to whom questions concerning the plan may be addressed. The person who submits the plan shall be the chief administrator or president of the institution, or another individual legally authorized to bind the institution to all actions set forth in the plan.

(2) State whether the educational institution or administratively separate unit admits students of both sexes as regular students and, if so, when it began to do so.

(3) Identify and describe with respect to the educational institution or administratively separate unit any obstacles to admitting students without discrimination on the basis of sex.

(4) Describe in detail the steps necessary to eliminate as soon as practicable each obstacle so identified and indicate the schedule for taking these steps and the individual directly responsible for their implementation.

(5) Include estimates of the number of students, by sex, expected to apply for, be admitted to, and enter each class during the period covered by the plan.

(c) *Nondiscrimination.* No policy or practice of a recipient to which § 101-4.225 applies shall result in treatment of applicants to or students of such recipient in violation of §§ 101-4.300 through 101-4.310 unless such treatment is necessitated by an obstacle identified in paragraph (b)(3) of this section and a schedule for eliminating that obstacle has been provided as required by paragraph (b)(4) of this section.

(d) *Effects of past exclusion.* To overcome the effects of past exclusion of students on the basis of sex, each educational institution to which § 101-4.225 applies shall include in its transition plan, and shall implement, specific steps designed to encourage individuals of the previously excluded sex to apply

41 CFR Ch. 101 (7-1-01 Edition)

for admission to such institution. Such steps shall include instituting recruitment programs that emphasize the institution's commitment to enrolling students of the sex previously excluded.

§ 101-4.235 Statutory amendments.

(a) This section, which applies to all provisions of these Title IX regulations, addresses statutory amendments to Title IX.

(b) These Title IX regulations shall not apply to or preclude:

(1) Any program or activity of the American Legion undertaken in connection with the organization or operation of any Boys State conference, Boys Nation conference, Girls State conference, or Girls Nation conference;

(2) Any program or activity of a secondary school or educational institution specifically for:

(i) The promotion of any Boys State conference, Boys Nation conference, Girls State conference, or Girls Nation conference; or

(ii) The selection of students to attend any such conference;

(3) Father-son or mother-daughter activities at an educational institution or in an education program or activity, but if such activities are provided for students of one sex, opportunities for reasonably comparable activities shall be provided to students of the other sex;

(4) Any scholarship or other financial assistance awarded by an institution of higher education to an individual because such individual has received such award in a single-sex pageant based upon a combination of factors related to the individual's personal appearance, poise, and talent. The pageant, however, must comply with other nondiscrimination provisions of Federal law.

(c) *Program or activity or program* means:

(1) All of the operations of any entity described in paragraphs (c)(1)(i) through (iv) of this section, any part of which is extended Federal financial assistance:

(i)(A) A department, agency, special purpose district, or other instrumentality of a State or of a local government; or

Federal Property Management Regulations

§ 101-4.300

(B) The entity of such State or local government that distributes such assistance and each such department or agency (and each other State or local government entity) to which the assistance is extended, in the case of assistance to a State or local government;

(ii)(A) A college, university, or other postsecondary institution, or a public system of higher education; or

(B) A local educational agency (as defined in section 8801 of title 20), system of vocational education, or other school system;

(iii)(A) An entire corporation, partnership, or other private organization, or an entire sole proprietorship—

(1) If assistance is extended to such corporation, partnership, private organization, or sole proprietorship as a whole; or

(2) Which is principally engaged in the business of providing education, health care, housing, social services, or parks and recreation; or

(B) The entire plant or other comparable, geographically separate facility to which Federal financial assistance is extended, in the case of any other corporation, partnership, private organization, or sole proprietorship; or

(iv) Any other entity that is established by two or more of the entities described in paragraphs (c)(1)(i), (ii), or (iii) of this section.

(2)(i) *Program or activity* does not include any operation of an entity that is controlled by a religious organization if the application of 20 U.S.C. 1681 to such operation would not be consistent with the religious tenets of such organization.

(ii) For example, all of the operations of a college, university, or other postsecondary institution, including but not limited to traditional educational operations, faculty and student housing, campus shuttle bus service, campus restaurants, the bookstore, and other commercial activities are part of a “program or activity” subject to these Title IX regulations if the college, university, or other institution receives Federal financial assistance.

(d)(1) Nothing in these Title IX regulations shall be construed to require or prohibit any person, or public or private entity, to provide or pay for any

benefit or service, including the use of facilities, related to an abortion. Medical procedures, benefits, services, and the use of facilities, necessary to save the life of a pregnant woman or to address complications related to an abortion are not subject to this section.

(2) Nothing in this section shall be construed to permit a penalty to be imposed on any person or individual because such person or individual is seeking or has received any benefit or service related to a legal abortion. Accordingly, subject to paragraph (d)(1) of this section, no person shall be excluded from participation in, be denied the benefits of, or be subjected to discrimination under any academic, extracurricular, research, occupational training, employment, or other educational program or activity operated by a recipient that receives Federal financial assistance because such individual has sought or received, or is seeking, a legal abortion, or any benefit or service related to a legal abortion.

Subpart C—Discrimination on the Basis of Sex in Admission and Recruitment Prohibited

§ 101-4.300 Admission.

(a) *General.* No person shall, on the basis of sex, be denied admission, or be subjected to discrimination in admission, by any recipient to which §§101-4.300 through 101-4.310 apply, except as provided in §§ 101-4.225 and 101-4.230.

(b) *Specific prohibitions.* (1) In determining whether a person satisfies any policy or criterion for admission, or in making any offer of admission, a recipient to which §§101-4.300 through 101-4.310 apply shall not:

(i) Give preference to one person over another on the basis of sex, by ranking applicants separately on such basis, or otherwise;

(ii) Apply numerical limitations upon the number or proportion of persons of either sex who may be admitted; or

(iii) Otherwise treat one individual differently from another on the basis of sex.

(2) A recipient shall not administer or operate any test or other criterion for admission that has a disproportionately adverse effect on persons on the

§ 101-4.305

basis of sex unless the use of such test or criterion is shown to predict validly success in the education program or activity in question and alternative tests or criteria that do not have such a disproportionately adverse effect are shown to be unavailable.

(c) *Prohibitions relating to marital or parental status.* In determining whether a person satisfies any policy or criterion for admission, or in making any offer of admission, a recipient to which §§ 101-4.300 through 101-4.310 apply:

(1) Shall not apply any rule concerning the actual or potential parental, family, or marital status of a student or applicant that treats persons differently on the basis of sex;

(2) Shall not discriminate against or exclude any person on the basis of pregnancy, childbirth, termination of pregnancy, or recovery therefrom, or establish or follow any rule or practice that so discriminates or excludes;

(3) Subject to § 101-4.235(d), shall treat disabilities related to pregnancy, childbirth, termination of pregnancy, or recovery therefrom in the same manner and under the same policies as any other temporary disability or physical condition; and

(4) Shall not make pre-admission inquiry as to the marital status of an applicant for admission, including whether such applicant is “Miss” or “Mrs.” A recipient may make pre-admission inquiry as to the sex of an applicant for admission, but only if such inquiry is made equally of such applicants of both sexes and if the results of such inquiry are not used in connection with discrimination prohibited by these Title IX regulations.

§ 101-4.305 Preference in admission.

A recipient to which §§ 101-4.300 through 101-4.310 apply shall not give preference to applicants for admission, on the basis of attendance at any educational institution or other school or entity that admits as students only or predominantly members of one sex, if the giving of such preference has the effect of discriminating on the basis of sex in violation of §§ 101-4.300 through 101-4.310.

41 CFR Ch. 101 (7-1-01 Edition)

§ 101-4.310 Recruitment.

(a) *Nondiscriminatory recruitment.* A recipient to which §§ 101-4.300 through 101-4.310 apply shall not discriminate on the basis of sex in the recruitment and admission of students. A recipient may be required to undertake additional recruitment efforts for one sex as remedial action pursuant to § 101-4.110(a), and may choose to undertake such efforts as affirmative action pursuant to § 101-4.110(b).

(b) *Recruitment at certain institutions.* A recipient to which §§ 101-4.300 through 101-4.310 apply shall not recruit primarily or exclusively at educational institutions, schools, or entities that admit as students only or predominantly members of one sex, if such actions have the effect of discriminating on the basis of sex in violation of §§ 101-4.300 through 101-4.310.

Subpart D—Discrimination on the Basis of Sex in Education Programs or Activities Prohibited

§ 101-4.400 Education programs or activities.

(a) *General.* Except as provided elsewhere in these Title IX regulations, no person shall, on the basis of sex, be excluded from participation in, be denied the benefits of, or be subjected to discrimination under any academic, extracurricular, research, occupational training, or other education program or activity operated by a recipient that receives Federal financial assistance. Sections 101-4.400 through 101-4.455 do not apply to actions of a recipient in connection with admission of its students to an education program or activity of a recipient to which §§ 101-4.300 through 101-4.310 do not apply, or an entity, not a recipient, to which §§ 101-4.300 through 101-4.310 would not apply if the entity were a recipient.

(b) *Specific prohibitions.* Except as provided in §§ 101-4.400 through 101-4.455, in providing any aid, benefit, or service to a student, a recipient shall not, on the basis of sex:

(1) Treat one person differently from another in determining whether such person satisfies any requirement or condition for the provision of such aid, benefit, or service;

Federal Property Management Regulations

§ 101-4.405

(2) Provide different aid, benefits, or services or provide aid, benefits, or services in a different manner;

(3) Deny any person any such aid, benefit, or service;

(4) Subject any person to separate or different rules of behavior, sanctions, or other treatment;

(5) Apply any rule concerning the domicile or residence of a student or applicant, including eligibility for in-state fees and tuition;

(6) Aid or perpetuate discrimination against any person by providing significant assistance to any agency, organization, or person that discriminates on the basis of sex in providing any aid, benefit, or service to students or employees;

(7) Otherwise limit any person in the enjoyment of any right, privilege, advantage, or opportunity.

(c) *Assistance administered by a recipient educational institution to study at a foreign institution.* A recipient educational institution may administer or assist in the administration of scholarships, fellowships, or other awards established by foreign or domestic wills, trusts, or similar legal instruments, or by acts of foreign governments and restricted to members of one sex, that are designed to provide opportunities to study abroad, and that are awarded to students who are already matriculating at or who are graduates of the recipient institution; *Provided*, that a recipient educational institution that administers or assists in the administration of such scholarships, fellowships, or other awards that are restricted to members of one sex provides, or otherwise makes available, reasonable opportunities for similar studies for members of the other sex. Such opportunities may be derived from either domestic or foreign sources.

(d) *Aids, benefits or services not provided by recipient.* (1) This paragraph (d) applies to any recipient that requires participation by any applicant, student, or employee in any education program or activity not operated wholly by such recipient, or that facilitates, permits, or considers such participation as part of or equivalent to an education program or activity operated by such recipient, including participation

in educational consortia and cooperative employment and student-teaching assignments.

(2) Such recipient:

(i) Shall develop and implement a procedure designed to assure itself that the operator or sponsor of such other education program or activity takes no action affecting any applicant, student, or employee of such recipient that these Title IX regulations would prohibit such recipient from taking; and

(ii) Shall not facilitate, require, permit, or consider such participation if such action occurs.

§ 101-4.405 Housing.

(a) *Generally.* A recipient shall not, on the basis of sex, apply different rules or regulations, impose different fees or requirements, or offer different services or benefits related to housing, except as provided in this section (including housing provided only to married students).

(b) *Housing provided by recipient.* (1) A recipient may provide separate housing on the basis of sex.

(2) Housing provided by a recipient to students of one sex, when compared to that provided to students of the other sex, shall be as a whole:

(i) Proportionate in quantity to the number of students of that sex applying for such housing; and

(ii) Comparable in quality and cost to the student.

(c) *Other housing.* (1) A recipient shall not, on the basis of sex, administer different policies or practices concerning occupancy by its students of housing other than that provided by such recipient.

(2)(i) A recipient which, through solicitation, listing, approval of housing, or otherwise, assists any agency, organization, or person in making housing available to any of its students, shall take such reasonable action as may be necessary to assure itself that such housing as is provided to students of one sex, when compared to that provided to students of the other sex, is as a whole:

(A) Proportionate in quantity; and

(B) Comparable in quality and cost to the student.

(ii) A recipient may render such assistance to any agency, organization,

§ 101-4.410

or person that provides all or part of such housing to students of only one sex.

§ 101-4.410 Comparable facilities.

A recipient may provide separate toilet, locker room, and shower facilities on the basis of sex, but such facilities provided for students of one sex shall be comparable to such facilities provided for students of the other sex.

§ 101-4.415 Access to course offerings.

(a) A recipient shall not provide any course or otherwise carry out any of its education program or activity separately on the basis of sex, or require or refuse participation therein by any of its students on such basis, including health, physical education, industrial, business, vocational, technical, home economics, music, and adult education courses.

(b)(1) With respect to classes and activities in physical education at the elementary school level, the recipient shall comply fully with this section as expeditiously as possible but in no event later than one year from September 29, 2000. With respect to physical education classes and activities at the secondary and post-secondary levels, the recipient shall comply fully with this section as expeditiously as possible but in no event later than three years from September 29, 2000.

(2) This section does not prohibit grouping of students in physical education classes and activities by ability as assessed by objective standards of individual performance developed and applied without regard to sex.

(3) This section does not prohibit separation of students by sex within physical education classes or activities during participation in wrestling, boxing, rugby, ice hockey, football, basketball, and other sports the purpose or major activity of which involves bodily contact.

(4) Where use of a single standard of measuring skill or progress in a physical education class has an adverse effect on members of one sex, the recipient shall use appropriate standards that do not have such effect.

(5) Portions of classes in elementary and secondary schools, or portions of education programs or activities, that

41 CFR Ch. 101 (7-1-01 Edition)

deal exclusively with human sexuality may be conducted in separate sessions for boys and girls.

(6) Recipients may make requirements based on vocal range or quality that may result in a chorus or choruses of one or predominantly one sex.

§ 101-4.420 Access to schools operated by LEAs.

A recipient that is a local educational agency shall not, on the basis of sex, exclude any person from admission to:

(a) Any institution of vocational education operated by such recipient; or

(b) Any other school or educational unit operated by such recipient, unless such recipient otherwise makes available to such person, pursuant to the same policies and criteria of admission, courses, services, and facilities comparable to each course, service, and facility offered in or through such schools.

§ 101-4.425 Counseling and use of appraisal and counseling materials.

(a) *Counseling.* A recipient shall not discriminate against any person on the basis of sex in the counseling or guidance of students or applicants for admission.

(b) *Use of appraisal and counseling materials.* A recipient that uses testing or other materials for appraising or counseling students shall not use different materials for students on the basis of their sex or use materials that permit or require different treatment of students on such basis unless such different materials cover the same occupations and interest areas and the use of such different materials is shown to be essential to eliminate sex bias. Recipients shall develop and use internal procedures for ensuring that such materials do not discriminate on the basis of sex. Where the use of a counseling test or other instrument results in a substantially disproportionate number of members of one sex in any particular course of study or classification, the recipient shall take such action as is necessary to assure itself that such disproportion is not the result of discrimination in the instrument or its application.

Federal Property Management Regulations

§ 101-4.440

(c) *Disproportion in classes.* Where a recipient finds that a particular class contains a substantially disproportionate number of individuals of one sex, the recipient shall take such action as is necessary to assure itself that such disproportion is not the result of discrimination on the basis of sex in counseling or appraisal materials or by counselors.

§ 101-4.430 Financial assistance.

(a) *General.* Except as provided in paragraphs (b) and (c) of this section, in providing financial assistance to any of its students, a recipient shall not:

(1) On the basis of sex, provide different amounts or types of such assistance, limit eligibility for such assistance that is of any particular type or source, apply different criteria, or otherwise discriminate;

(2) Through solicitation, listing, approval, provision of facilities, or other services, assist any foundation, trust, agency, organization, or person that provides assistance to any of such recipient's students in a manner that discriminates on the basis of sex; or

(3) Apply any rule or assist in application of any rule concerning eligibility for such assistance that treats persons of one sex differently from persons of the other sex with regard to marital or parental status.

(b) *Financial aid established by certain legal instruments.* (1) A recipient may administer or assist in the administration of scholarships, fellowships, or other forms of financial assistance established pursuant to domestic or foreign wills, trusts, bequests, or similar legal instruments or by acts of a foreign government that require that awards be made to members of a particular sex specified therein; *Provided*, that the overall effect of the award of such sex-restricted scholarships, fellowships, and other forms of financial assistance does not discriminate on the basis of sex.

(2) To ensure nondiscriminatory awards of assistance as required in paragraph (b)(1) of this section, recipients shall develop and use procedures under which:

(i) Students are selected for award of financial assistance on the basis of nondiscriminatory criteria and not on

the basis of availability of funds restricted to members of a particular sex;

(ii) An appropriate sex-restricted scholarship, fellowship, or other form of financial assistance is allocated to each student selected under paragraph (b)(2)(i) of this section; and

(iii) No student is denied the award for which he or she was selected under paragraph (b)(2)(i) of this section because of the absence of a scholarship, fellowship, or other form of financial assistance designated for a member of that student's sex.

(c) *Athletic scholarships.* (1) To the extent that a recipient awards athletic scholarships or grants-in-aid, it must provide reasonable opportunities for such awards for members of each sex in proportion to the number of students of each sex participating in interscholastic or intercollegiate athletics.

(2) A recipient may provide separate athletic scholarships or grants-in-aid for members of each sex as part of separate athletic teams for members of each sex to the extent consistent with this paragraph (c) and § 101-4.450.

§ 101-4.435 Employment assistance to students.

(a) *Assistance by recipient in making available outside employment.* A recipient that assists any agency, organization, or person in making employment available to any of its students:

(1) Shall assure itself that such employment is made available without discrimination on the basis of sex; and

(2) Shall not render such services to any agency, organization, or person that discriminates on the basis of sex in its employment practices.

(b) *Employment of students by recipients.* A recipient that employs any of its students shall not do so in a manner that violates §§ 101-4.500 through 101-4.550.

§ 101-4.440 Health and insurance benefits and services.

Subject to § 101-4.235(d), in providing a medical, hospital, accident, or life insurance benefit, service, policy, or plan to any of its students, a recipient shall not discriminate on the basis of sex, or provide such benefit, service, policy, or plan in a manner that would violate §§ 101-4.500 through 101-4.550 if it were

§ 101-4.445

provided to employees of the recipient. This section shall not prohibit a recipient from providing any benefit or service that may be used by a different proportion of students of one sex than of the other, including family planning services. However, any recipient that provides full coverage health service shall provide gynecological care.

§ 101-4.445 Marital or parental status.

(a) *Status generally.* A recipient shall not apply any rule concerning a student's actual or potential parental, family, or marital status that treats students differently on the basis of sex.

(b) *Pregnancy and related conditions.* (1) A recipient shall not discriminate against any student, or exclude any student from its education program or activity, including any class or extracurricular activity, on the basis of such student's pregnancy, childbirth, false pregnancy, termination of pregnancy, or recovery therefrom, unless the student requests voluntarily to participate in a separate portion of the program or activity of the recipient.

(2) A recipient may require such a student to obtain the certification of a physician that the student is physically and emotionally able to continue participation as long as such a certification is required of all students for other physical or emotional conditions requiring the attention of a physician.

(3) A recipient that operates a portion of its education program or activity separately for pregnant students, admittance to which is completely voluntary on the part of the student as provided in paragraph (b)(1) of this section, shall ensure that the separate portion is comparable to that offered to non-pregnant students.

(4) Subject to §101-4.235(d), a recipient shall treat pregnancy, childbirth, false pregnancy, termination of pregnancy and recovery therefrom in the same manner and under the same policies as any other temporary disability with respect to any medical or hospital benefit, service, plan, or policy that such recipient administers, operates, offers, or participates in with respect to students admitted to the recipient's educational program or activity.

(5) In the case of a recipient that does not maintain a leave policy for its stu-

41 CFR Ch. 101 (7-1-01 Edition)

dents, or in the case of a student who does not otherwise qualify for leave under such a policy, a recipient shall treat pregnancy, childbirth, false pregnancy, termination of pregnancy, and recovery therefrom as a justification for a leave of absence for as long a period of time as is deemed medically necessary by the student's physician, at the conclusion of which the student shall be reinstated to the status that she held when the leave began.

§ 101-4.450 Athletics.

(a) *General.* No person shall, on the basis of sex, be excluded from participation in, be denied the benefits of, be treated differently from another person, or otherwise be discriminated against in any interscholastic, intercollegiate, club, or intramural athletics offered by a recipient, and no recipient shall provide any such athletics separately on such basis.

(b) *Separate teams.* Notwithstanding the requirements of paragraph (a) of this section, a recipient may operate or sponsor separate teams for members of each sex where selection for such teams is based upon competitive skill or the activity involved is a contact sport. However, where a recipient operates or sponsors a team in a particular sport for members of one sex but operates or sponsors no such team for members of the other sex, and athletic opportunities for members of that sex have previously been limited, members of the excluded sex must be allowed to try out for the team offered unless the sport involved is a contact sport. For the purposes of these Title IX regulations, contact sports include boxing, wrestling, rugby, ice hockey, football, basketball, and other sports the purpose or major activity of which involves bodily contact.

(c) *Equal opportunity.* (1) A recipient that operates or sponsors interscholastic, intercollegiate, club, or intramural athletics shall provide equal athletic opportunity for members of both sexes. In determining whether equal opportunities are available, the designated agency official will consider, among other factors:

(i) Whether the selection of sports and levels of competition effectively

Federal Property Management Regulations

§ 101-4.500

accommodate the interests and abilities of members of both sexes;

(ii) The provision of equipment and supplies;

(iii) Scheduling of games and practice time;

(iv) Travel and per diem allowance;

(v) Opportunity to receive coaching and academic tutoring;

(vi) Assignment and compensation of coaches and tutors;

(vii) Provision of locker rooms, practice, and competitive facilities;

(viii) Provision of medical and training facilities and services;

(ix) Provision of housing and dining facilities and services;

(x) Publicity.

(2) For purposes of paragraph (c)(1) of this section, unequal aggregate expenditures for members of each sex or unequal expenditures for male and female teams if a recipient operates or sponsors separate teams will not constitute noncompliance with this section, but the designated agency official may consider the failure to provide necessary funds for teams for one sex in assessing equality of opportunity for members of each sex.

(d) *Adjustment period.* A recipient that operates or sponsors interscholastic, intercollegiate, club, or intramural athletics at the elementary school level shall comply fully with this section as expeditiously as possible but in no event later than one year from September 29, 2000. A recipient that operates or sponsors interscholastic, intercollegiate, club, or intramural athletics at the secondary or postsecondary school level shall comply fully with this section as expeditiously as possible but in no event later than three years from September 29, 2000.

§ 101-4.455 Textbooks and curricular material.

Nothing in these Title IX regulations shall be interpreted as requiring or prohibiting or abridging in any way the use of particular textbooks or curricular materials.

Subpart E—Discrimination on the Basis of Sex in Employment in Education Programs or Activities Prohibited

§ 101-4.500 Employment.

(a) *General.* (1) No person shall, on the basis of sex, be excluded from participation in, be denied the benefits of, or be subjected to discrimination in employment, or recruitment, consideration, or selection therefor, whether full-time or part-time, under any education program or activity operated by a recipient that receives Federal financial assistance.

(2) A recipient shall make all employment decisions in any education program or activity operated by such recipient in a nondiscriminatory manner and shall not limit, segregate, or classify applicants or employees in any way that could adversely affect any applicant's or employee's employment opportunities or status because of sex.

(3) A recipient shall not enter into any contractual or other relationship which directly or indirectly has the effect of subjecting employees or students to discrimination prohibited by §§ 101-4.500 through 101-4.550, including relationships with employment and referral agencies, with labor unions, and with organizations providing or administering fringe benefits to employees of the recipient.

(4) A recipient shall not grant preferences to applicants for employment on the basis of attendance at any educational institution or entity that admits as students only or predominantly members of one sex, if the giving of such preferences has the effect of discriminating on the basis of sex in violation of these Title IX regulations.

(b) *Application.* The provisions of §§ 101-4.500 through 101-4.550 apply to:

(1) Recruitment, advertising, and the process of application for employment;

(2) Hiring, upgrading, promotion, consideration for and award of tenure, demotion, transfer, layoff, termination, application of nepotism policies, right of return from layoff, and rehiring;

§ 101-4.505

(3) Rates of pay or any other form of compensation, and changes in compensation;

(4) Job assignments, classifications, and structure, including position descriptions, lines of progression, and seniority lists;

(5) The terms of any collective bargaining agreement;

(6) Granting and return from leaves of absence, leave for pregnancy, childbirth, false pregnancy, termination of pregnancy, leave for persons of either sex to care for children or dependents, or any other leave;

(7) Fringe benefits available by virtue of employment, whether or not administered by the recipient;

(8) Selection and financial support for training, including apprenticeship, professional meetings, conferences, and other related activities, selection for tuition assistance, selection for sabbaticals and leaves of absence to pursue training;

(9) Employer-sponsored activities, including social or recreational programs; and

(10) Any other term, condition, or privilege of employment.

§ 101-4.505 Employment criteria.

A recipient shall not administer or operate any test or other criterion for any employment opportunity that has a disproportionately adverse effect on persons on the basis of sex unless:

(a) Use of such test or other criterion is shown to predict validly successful performance in the position in question; and

(b) Alternative tests or criteria for such purpose, which do not have such disproportionately adverse effect, are shown to be unavailable.

§ 101-4.510 Recruitment.

(a) *Nondiscriminatory recruitment and hiring.* A recipient shall not discriminate on the basis of sex in the recruitment and hiring of employees. Where a recipient has been found to be presently discriminating on the basis of sex in the recruitment or hiring of employees, or has been found to have so discriminated in the past, the recipient shall recruit members of the sex so discriminated against so as to overcome

41 CFR Ch. 101 (7-1-01 Edition)

the effects of such past or present discrimination.

(b) *Recruitment patterns.* A recipient shall not recruit primarily or exclusively at entities that furnish as applicants only or predominantly members of one sex if such actions have the effect of discriminating on the basis of sex in violation of §§101-4.500 through 101-4.550.

§ 101-4.515 Compensation.

A recipient shall not make or enforce any policy or practice that, on the basis of sex:

(a) Makes distinctions in rates of pay or other compensation;

(b) Results in the payment of wages to employees of one sex at a rate less than that paid to employees of the opposite sex for equal work on jobs the performance of which requires equal skill, effort, and responsibility, and that are performed under similar working conditions.

§ 101-4.520 Job classification and structure.

A recipient shall not:

(a) Classify a job as being for males or for females;

(b) Maintain or establish separate lines of progression, seniority lists, career ladders, or tenure systems based on sex; or

(c) Maintain or establish separate lines of progression, seniority systems, career ladders, or tenure systems for similar jobs, position descriptions, or job requirements that classify persons on the basis of sex, unless sex is a bona fide occupational qualification for the positions in question as set forth in §101-4.550.

§ 101-4.525 Fringe benefits.

(a) *“Fringe benefits” defined.* For purposes of these Title IX regulations, *fringe benefits* means: Any medical, hospital, accident, life insurance, or retirement benefit, service, policy or plan, any profit-sharing or bonus plan, leave, and any other benefit or service of employment not subject to the provision of §101-4.515.

(b) *Prohibitions.* A recipient shall not:

(1) Discriminate on the basis of sex with regard to making fringe benefits available to employees or make fringe

Federal Property Management Regulations

§ 101-4.550

benefits available to spouses, families, or dependents of employees differently upon the basis of the employee's sex;

(2) Administer, operate, offer, or participate in a fringe benefit plan that does not provide for equal periodic benefits for members of each sex and for equal contributions to the plan by such recipient for members of each sex; or

(3) Administer, operate, offer, or participate in a pension or retirement plan that establishes different optional or compulsory retirement ages based on sex or that otherwise discriminates in benefits on the basis of sex.

§ 101-4.530 Marital or parental status.

(a) *General.* A recipient shall not apply any policy or take any employment action:

(1) Concerning the potential marital, parental, or family status of an employee or applicant for employment that treats persons differently on the basis of sex; or

(2) Which is based upon whether an employee or applicant for employment is the head of household or principal wage earner in such employee's or applicant's family unit.

(b) *Pregnancy.* A recipient shall not discriminate against or exclude from employment any employee or applicant for employment on the basis of pregnancy, childbirth, false pregnancy, termination of pregnancy, or recovery therefrom.

(c) *Pregnancy as a temporary disability.* Subject to §101-4.235(d), a recipient shall treat pregnancy, childbirth, false pregnancy, termination of pregnancy, recovery therefrom, and any temporary disability resulting therefrom as any other temporary disability for all job-related purposes, including commencement, duration, and extensions of leave, payment of disability income, accrual of seniority and any other benefit or service, and reinstatement, and under any fringe benefit offered to employees by virtue of employment.

(d) *Pregnancy leave.* In the case of a recipient that does not maintain a leave policy for its employees, or in the case of an employee with insufficient leave or accrued employment time to qualify for leave under such a policy, a recipient shall treat pregnancy, childbirth, false pregnancy, termination of

pregnancy, and recovery therefrom as a justification for a leave of absence without pay for a reasonable period of time, at the conclusion of which the employee shall be reinstated to the status that she held when the leave began or to a comparable position, without decrease in rate of compensation or loss of promotional opportunities, or any other right or privilege of employment.

§ 101-4.535 Effect of state or local law or other requirements.

(a) *Prohibitory requirements.* The obligation to comply with §§101-4.500 through 101-4.550 is not obviated or alleviated by the existence of any State or local law or other requirement that imposes prohibitions or limits upon employment of members of one sex that are not imposed upon members of the other sex.

(b) *Benefits.* A recipient that provides any compensation, service, or benefit to members of one sex pursuant to a State or local law or other requirement shall provide the same compensation, service, or benefit to members of the other sex.

§ 101-4.540 Advertising.

A recipient shall not in any advertising related to employment indicate preference, limitation, specification, or discrimination based on sex unless sex is a bona fide occupational qualification for the particular job in question.

§ 101-4.545 Pre-employment inquiries.

(a) *Marital status.* A recipient shall not make pre-employment inquiry as to the marital status of an applicant for employment, including whether such applicant is "Miss" or "Mrs."

(b) *Sex.* A recipient may make pre-employment inquiry as to the sex of an applicant for employment, but only if such inquiry is made equally of such applicants of both sexes and if the results of such inquiry are not used in connection with discrimination prohibited by these Title IX regulations.

§ 101-4.550 Sex as a bona fide occupational qualification.

A recipient may take action otherwise prohibited by §§101-4.500 through 101-4.550 provided it is shown that sex

§ 101-4.600

is a bona fide occupational qualification for that action, such that consideration of sex with regard to such action is essential to successful operation of the employment function concerned. A recipient shall not take action pursuant to this section that is based upon alleged comparative employment characteristics or stereotyped characterizations of one or the other sex, or upon preference based on sex of the recipient, employees, students, or other persons, but nothing contained in this section shall prevent a recipient from considering an employee's sex in relation to employment in a locker room or toilet facility used only by members of one sex.

Subpart F—Procedures

§ 101-4.600 Notice of covered programs.

Within 60 days of September 29, 2000, each Federal agency that awards Federal financial assistance shall publish in the FEDERAL REGISTER a notice of the programs covered by these Title IX regulations. Each such Federal agency shall periodically republish the notice of covered programs to reflect changes in covered programs. Copies of this notice also shall be made available upon request to the Federal agency's office that enforces Title IX.

§ 101-4.605 Enforcement procedures.

The investigative, compliance, and enforcement procedural provisions of Title VI of the Civil Rights Act of 1964 (42 U.S.C. 2000d) ("Title VI") are hereby adopted and applied to these Title IX regulations. These procedures may be found at 41 CFR part 101-6, subpart 101-6.2.

PART 101-5—CENTRALIZED SERVICES IN FEDERAL BUILDINGS AND COMPLEXES

Sec.

101-5.000 Scope of part.

Subpart 101-5.1—General

101-5.100 Scope of subpart.
101-5.101 Applicability.
101-5.102 Definitions.
101-5.103 Policy.

41 CFR Ch. 101 (7-1-01 Edition)

101-5.104 Economic feasibility of centralized services.
101-5.104-1 General.
101-5.104-2 Basis for determining economic feasibility.
101-5.104-3 Data requirements for feasibility studies.
101-5.104-4 Scheduling feasibility studies.
101-5.104-5 Designating agency representatives.
101-5.104-6 Conduct of feasibility studies.
101-5.104-7 Administrator's determination.
101-5.105 Operation of the centralized facility.
101-5.106 Agency committees.

Subpart 101-5.2—Centralized Field Reproduction Services

101-5.200 Scope of subpart.
101-5.201 Applicability.
101-5.202 Types of centralized field reproduction services.
101-5.203 Economic feasibility of centralized field reproduction services.
101-5.203-1 Scheduling of feasibility studies.
101-5.203-2 Notification of feasibility studies.
101-5.203-3 Initiation of feasibility studies.
101-5.203-4 Duplicating Services—Individual Agency Survey.
101-5.203-5 Uniform space allowances.
101-5.203-6 Pooling of equipment and personnel.
101-5.203-7 Determination of feasibility.
101-5.204 Operation of centralized field reproduction facilities.
101-5.204-1 Continuity of service.
101-5.204-2 Announcement of centralized services.
101-5.204-3 Appraisal of operations.
101-5.205 Designation of other agencies to operate plants.
101-5.205-1 General.
101-5.205-2 Prerequisites to designation of other agencies.
101-5.205-3 Actions prior to operation of facilities.
101-5.205-4 Plant inspections and customer evaluations.

Subpart 101-5.3—Federal Employee Health Services

101-5.300 Scope of subpart.
101-5.301 Applicability.
101-5.302 Objective.
101-5.303 Guiding principles.
101-5.304 Type of occupational health services.
101-5.305 Agency participation.
101-5.306 Economic feasibility.
101-5.307 Public Health Service.

Subparts 101-5.4—101-5.48 [Reserved]

Federal Property Management Regulations

§ 101-5.104-1

Subpart 101-5.49—Forms, Reports, and Instructions

101-5.4900 Scope of subpart.

AUTHORITY: Sec. 205(c), 63 Stat. 390; 40 U.S.C. 486(c).

§ 101-5.000 Scope of part.

This part prescribes the methods by which the General Services Administration provides for establishment of centralized services in Federal buildings or complexes occupied by a number of executive agencies.

[56 FR 33873, July 24, 1991]

Subpart 101-5.1—General

SOURCE: 30 FR 4199, Mar. 31, 1965, unless otherwise noted.

§ 101-5.100 Scope of subpart.

This subpart states general policies, guidelines, and procedures for establishing centralized services in multi-occupant Federal buildings.

[42 FR 35853, July 12, 1977]

§ 101-5.101 Applicability.

The regulations in this part apply to all executive agencies which occupy space in or are prospective occupants of multi-occupant Federal buildings located in the United States. In appropriate circumstances, the centralized services provided pursuant to this part are extended to agencies occupying other Federal buildings in the same geographical area. For purposes of this part, reference to Federal buildings may be deemed to include, when appropriate, leased buildings or specific leased space in a commercial building under the control of GSA.

[56 FR 33873, July 24, 1991]

§ 101-5.102 Definitions.

(a) *Centralized services* means those central supporting and administrative services and facilities provided to occupying agencies in Federal buildings or nearby locations in lieu of each agency providing the same services or facilities for its own use. This includes those common administrative services provided by a Cooperative Administrative Support Unit (CASU). It does not in-

clude such common building features as cafeterias, blind stands, loading platforms, auditoriums, incinerators, or similar facilities. Excluded are interagency fleet management centers established pursuant to Public Law 766, 83d Congress, and covered by part 101-39 of this chapter.

(b) *Occupying agency* means any Federal agency assigned space in a building or complex for which GSA has oversight of, or responsibility for the functions of operation and maintenance in addition to space assignment.

(c) *Cooperative Administrative Support Unit (CASU)* means an organized mechanism for providing administrative services for agencies in multi-tenant federally occupied buildings.

[56 FR 33873, July 24, 1991]

§ 101-5.103 Policy.

To the extent practicable, GSA will provide or arrange for the provision of centralized services whenever such services insure increased efficiency and economy to the Government without hampering program activities or essential internal administration of the agencies to be served.

§ 101-5.104 Economic feasibility of centralized services.

§ 101-5.104-1 General.

GSA is currently providing various centralized services to Federal agencies in such fields as office and storage space, supplies and materials, communications, records management, transportation services, and printing and reprographics. Other centralized CASU's may be providing supporting services or activities such as health units, use of training devices and facilities, pistol ranges, and central facilities for receipt and dispatch of mail. Consolidation and sharing is frequently feasible with resulting economies in personnel, equipment, and space. Opportunities to effect economies through planned consolidation of such services occur particularly during the design stage of the construction of new Federal buildings, or the renovations to existing buildings. Opportunities may also occur as a result of needs

§ 101-5.104-2

assessments jointly conducted by local agencies.

[56 FR 33873, July 24, 1991]

§ 101-5.104-2 Basis for determining economic feasibility.

(a) Whenever possible, determination of the economic feasibility of a proposed centralized service shall be based upon standard data on the relationship of the size of the Federal building, the number of occupants, location, and other factors pertinent to the type of centralized service being considered.

(b) In the absence of standard data on which a determination of economic feasibility can be based, or where such data must be supplemented by additional factual information, a formal feasibility study may be made by GSA or a CASU workgroup, in coordination with local agencies to be involved, prior to a final determination to proceed with the furnishing of a centralized service. Generally, a formal feasibility study will be made only if provision of the proposed centralized service would involve the pooling of staff, equipment, and space which occupying agencies otherwise would be required to use in providing the service for themselves. Examples of centralized services which may require formal studies include printing and duplicating plants and similar facilities.

(c) On the basis of experience under the centralized services program, GSA will develop criteria as to cost comparisons, production needs, building population, number of agencies involved, and other appropriate factors for consideration in determining the practicability of establishing various types of centralized services.

[30 FR 4199, Mar. 31, 1965, as amended at 56 FR 33874, July 24, 1991]

§ 101-5.104-3 Data requirements for feasibility studies.

(a) The data requirements for feasibility studies may vary from program to program, but shall be standard within any single program. Such data shall disclose the costs resulting from provisions of the service on a centralized basis as compared to the same service provided separately by each occupying agency, including the costs of per-

41 CFR Ch. 101 (7-1-01 Edition)

sonnel assigned to provide the service, comparative space needs, equipment use, and any other pertinent factors.

(b) Wherever feasible and appropriate, data will be secured directly from the prospective occupying agencies, subject to necessary verification procedures. Suitable standard formats and necessary instructions for submission of data will be prescribed in applicable subchapters of chapter 101.

(c) Agencies required to submit data for a feasibility study will be furnished with copies of the prescribed reporting forms and such assistance as may be needed to assure their accurate and timely completion.

[30 FR 4199, Mar. 31, 1965, as amended at 56 FR 33874, July 24, 1991]

§ 101-5.104-4 Scheduling feasibility studies.

The schedule of feasibility studies will be coordinated by GSA with its construction, space management, and buildings management programs. Before initiating the study, the Administrator of General Services, or his authorized designee, will give at least 30 days' notice to the head of each agency that would be served by the proposed centralized facility. Such notice will contain an indication of the cost elements involved and the general procedures to be followed in the study.

§ 101-5.104-5 Designating agency representatives.

The head of each agency receiving a GSA notice regarding a scheduled feasibility study will be requested to designate one or more officials at the location where the study will be made who may consult with authorized GSA representatives. Such information and assistance as is required or pertinent for an adequate review of the feasibility of the proposed centralized service shall be made available to GSA through the designated agency representatives.

§ 101-5.104-6 Conduct of feasibility studies.

An initial meeting of the representatives of prospective occupying agencies will be held to discuss the objectives and detailed procedures to be followed in the conduct of each feasibility

Federal Property Management Regulations

§ 101-5.106

study. Arrangements will be made at this meeting for securing all necessary data in accordance with §101-5.104-3.

§ 101-5.104-7 Administrator's determination.

(a) The Administrator of General Services will determine, on the basis of the feasibility study, whether provision of a centralized service meets the criteria for increased economy, efficiency, and service, with due regard to the program and internal administrative requirements of the agencies to be served. The Director of the Office of Management and Budget and the head of each agency affected will be advised of the Administrator's determination and of the reasons therefor. Each determination to provide a centralized service shall include a formal report containing an explanation of the advantages to be gained, a comparison of estimated annual costs between the proposed centralized operation and separate agency operations, and a statement of the date the centralized facility will be fully operational.

(b) While a formal appeals procedure is not prescribed, any agency desiring to explain its inability to participate in the use of a centralized service may do so through a letter to the Director of the Office of Management and Budget, with a copy to the Administrator of General Services.

[42 FR 35853, July 12, 1977]

§ 101-5.105 Operation of the centralized facility.

(a) GSA will continually appraise the operation of centralized facilities to insure their continued justification in terms of economy and efficiency. Centralized services provided pursuant to the regulation may be discontinued or curtailed if no actual savings or operating improvements are realized after a minimum operating period of one year. Occupying agencies will be consulted regarding the timing of curtailment or discontinuance of any centralized services and the heads of such agencies notified at least 120 days in advance of each action.

(b) Where mutual agreement is reached, an agency other than GSA may be designated by the Adminis-

trator of General Services to administer the centralized service.

(c) Arrangements with regard to financing will conform to the special requirements of each type of centralized service and to existing law. Normally, reimbursement will be made for the use of established services except where the cost is nominal or where reimbursement may not be practicable.

[30 FR 4199, Mar. 31, 1965, as amended at 56 FR 33874, July 24, 1991]

§ 101-5.106 Agency committees.

(a) *Establishment.* An occupying agency committee will be established by GSA if one does not exist, to assist the occupying agency, or such other agency as may be responsible, in the cooperative use of the centralized services, as defined in 101-5.102(a), provided in a Federal building. Generally, such a committee will be established when the problems of administration and coordination necessitate a formal method of consultation and discussion among occupying agencies.

(b) *Membership.* Each occupying agency of a Federal building is entitled to membership on an agency committee. The chairperson of each such committee shall be a GSA employee designated by the appropriate GSA Regional Administrator, except when another agency had been designated to administer the centralized service. In this instance, the chairperson shall be an employee of such other agency as designated by competent authority within that agency.

(c) *Activities.* Agency committees shall be advisory in nature and shall be concerned with the effectiveness of centralized services in the building. Recommendations of an agency committee will be forwarded by the chairman to the appropriate GSA officials for consideration and decision.

(d) *Reports.* A résumé of the minutes of each meeting of an agency committee shall be furnished to each member of the committee and to the appropriate GSA Regional Administrator.

[30 FR 4199, Mar. 31, 1965, as amended at 56 FR 33874, July 24, 1991]

**Subpart 101-5.2—Centralized Field
Reproduction Services**

§ 101-5.200 Scope of subpart.

This subpart states general guidelines and procedures for the establishment and operation of centralized field printing, duplicating, and photocopying services on a reimbursable basis. These services may be provided in multi-occupant leased and/or government-owned buildings.

[56 FR 33874, July 24, 1991]

§ 101-5.201 Applicability.

This subpart is applicable to all executive agencies which occupy space in or are prospective occupants of a multioccupant Federal building or complex located in the United States.

[41 FR 46296, Oct. 20, 1976]

**§ 101-5.202 Types of centralized field
reproduction services.**

With due regard to the rules and regulations of the Joint Committee on Printing, the types of centralized field duplicating services made available by GSA to occupying agencies in a Federal building or complex will be as follows:

(a) Services will include offset reproduction, electronic publishing, photocopying, distribution, bindery services, and other closely related services as requested or required.

(b) Qualified specialists will be available for advice and guidance on publications management.

[30 FR 4358, Apr. 3, 1965, as amended at 41 FR 46296, Oct. 20, 1976; 56 FR 33874, July 24, 1991]

§ 101-5.203 Economic feasibility of centralized field reproduction services.

§ 101-5.203-1 Scheduling of feasibility studies.

(a) Based on the available data on the proposed size, location, number of agencies scheduled for occupancy, and other factors pertinent to a proposed new or acquired Federal building, GSA may determine whether to provide for a centralized field reproduction facility in the space directive covering the new building. A feasibility study thereafter will be scheduled and coordinated with the Federal building program of the

Public Buildings Service, GSA, and the occupying agencies to occur during the period following development of the prospectus and before development of final working drawings for the space directive. The final decision to provide centralized field reproduction services in a new or acquired Federal building will be subject to subsequent determination by the GSA Administrator based upon results of the formal feasibility study. Agencies wishing not to participate may do so by requesting an exception from the appropriate GSA Regional Administrator.

(b) Feasibility studies may be initiated by GSA and coordinated with occupying agencies in existing Federal buildings. Such studies will be conducted in accordance with the rules prescribed in 101-5.203.

[56 FR 33874, July 24, 1991]

§ 101-5.203-2 Notification of feasibility studies.

The Administrator of General Services, or his authorized designee, will give at least 30 days notice to the head of each executive agency that would be served by a proposed centralized field reproduction facility in accordance with 101-5.104-4, and will request the designation of agency representatives, as provided in 101-5.104-5.

[56 FR 33874, July 24, 1991]

§ 101-5.203-3 Initiation of feasibility studies.

Each feasibility study will be initiated with a general meeting of designated agency representatives, as provided in § 101-5.104-6.

§ 101-5.203-4 Duplicating Services—Individual Agency Survey.

Each agency covered by a feasibility study will be requested, through its designated local representative, to complete and furnish to the appropriate GSA regional office GSA Form 3300, Duplicating Services—Individual Agency Survey. When necessary, representatives of the GSA regional printing and distribution activity will be available to assist in completion of the GSA Form 3300. Copies of GSA Form 3300 will be furnished to the agencies

Federal Property Management Regulations

§ 101-5.203-7

by GSA regional offices at the time the request for completion is made.

[41 FR 46296, Oct. 20, 1976]

§ 101-5.203-5 Uniform space allowances.

The space requirements for printing, duplicating, photocopying, and related equipment under individual agency use as compared with use in a centralized facility will be based upon uniform space allowances applied equally under both conditions.

[56 FR 33874, July 24, 1991]

§ 101-5.203-6 Pooling of equipment and personnel.

(a) In establishing centralized reproduction facilities in Federal buildings or complexes, GSA's regional office will make arrangements with participating agencies for the transfer of duplicating and related equipment for the centralized plant. Equipment for which there is no foreseeable need in the centralized plant will not be transferred to the plant but will be disposed of or transferred by the owning agency out of the centralized plant. Copy processing machines, as provided in paragraph (b) of this section, as well as reproduction, addressing, and automatic-copy processing equipment used in bona fide systems applications may be retained by mutual agreement with user agencies.

(b) All copy-processing machines having a maximum speed of 25 copies a minute or less are exempted from transfer to the centralized plant, subject to the following conditions:

(1) No automatic document feeders, sorting mechanisms, or similar devices that encourage the use of the copier as a duplicating machine will be permitted, except in certified bona fide systems applications approved in advance by GSA.

(2) All purchase orders for new copying equipment or for continuation of existing equipment shall be submitted to the centralized facility manager for approval prior to release to the vendor.

(3) Exempted copiers, other than in bona fide systems applications provided in this §101-5.203-6, are to be used for making not more than 20 copies of any one original. Requirements for

more than 20 copies shall be submitted to the centralized facility for reproduction.

(4) The centralized facility manager shall periodically inspect agency copiers to ensure compliance with the terms of the exemption provisions. Following such inspections, action shall be taken first at the local level, then, if necessary, at the headquarters level, to promptly remove any unauthorized equipment, attachments, and devices not in consonance with these provisions.

(c) Personnel devoting over 50 percent of time to the duplicating activities of the affected agency will be identified for transfer to the operating agency upon establishment of a centralized plant, in accordance with the Office of Personnel Management regulations relating to the transfer of functions. Agencies will transfer personnel ceiling to the operating agency for employees so transferred. In the event of later disestablishment of the centralized facility or substantial reduction in operations thereof, personnel ceiling will be returned to the agencies from which originally received.

(d) Exceptions to pooling of equipment to meet the individual agency programmatic need, special physical security needs, confidentiality requirements, and/or certain quality standards will be made available to occupant agencies when use of such equipment is justified. Each agency must provide justification for approval of the GSA regional printing and distribution activity before acquiring space and/or electrical service from the building's manager. Otherwise, as agreed by the user agencies, GSA will not make available space for duplicating equipment, or provide other support services for such equipment in Federal buildings where use of that equipment would duplicate the services provided by the centralized services plant.

[41 FR 46296, Oct. 20, 1976, as amended at 56 FR 33875, July 24, 1991]

§ 101-5.203-7 Determination of feasibility.

The Administrator of General Services will determine the economic feasibility of each proposed centralized field reproduction facility in accordance

§ 101-5.204

with 101-5.104-7. The Director of the Office of Management and Budget and the head of each affected agency will be advised of the Administrator's determination to establish a centralized facility.

[56 FR 33875, July 24, 1991]

§ 101-5.204 Operation of centralized field reproduction facilities.

§ 101-5.204-1 Continuity of service.

Each new centralized field reproduction facility will be established in sufficient time to assure occupants moving into the building that there will be no interruption of duplicating services in support of their program activities.

[56 FR 33875, July 24, 1991]

§ 101-5.204-2 Announcement of centralized services.

The appropriate GSA regional office will announce the availability of a centralized field reproduction facility approximately 90 days in advance of its activation, including:

- (a) The date service will be available;
- (b) The services which will be furnished, including technical assistance on reproduction problems;
- (c) A current price schedule;
- (d) Procedures for obtaining service; and
- (e) Billing procedures.

[56 FR 33875, July 24, 1991]

§ 101-5.204-3 Appraisal of operations.

(a) The appropriate GSA regional office will appraise continually the operation of each centralized field reproduction facility. Proposals to expand, modify, or discontinue a centralized activity shall be made to the Director, Reproduction Services Division, in the Central Office, and must be supported by all pertinent information.

(b) The Administrator of General Services will give a minimum of 120 days notice to the heads of agencies concerned before any action to curtail or discontinue centralized services is taken.

[56 FR 33875, July 24, 1991]

41 CFR Ch. 101 (7-1-01 Edition)

§ 101-5.205 Designation of other agencies to operate plants.

§ 101-5.205-1 General.

The Administrator of General Services, in accordance with 101-5.105(b), may designate an agency other than GSA to operate a centralized field reproduction facility. Such designation will be made only by mutual agreement with the agency head concerned.

[56 FR 33875, July 24, 1991]

§ 101-5.205-2 Prerequisites to designation of other agencies.

The following conditions are to be met by an agency designated by GSA to operate a centralized field reproduction facility:

(a) Generally, prices charged to Government agencies using the centralized field facility should be no higher than those specified on the currently effective nationwide uniform General Services Administration Reproduction Services Price Schedule. In special circumstances, deviations from the Price Schedule may be developed jointly by GSA and the designated agency.

(b) The designated agency shall accept responsibility for implementing the determination of the Administrator of General Services to establish a centralized reproduction facility, issued in accordance with 101-5.104-7 and 101-5.203-7, including the provisions for transfer of excess equipment and other procedures and conditions specified in that determination. Necessary deviations from the determination may be developed jointly by GSA and the designated agency.

[56 FR 33875, July 24, 1991]

§ 101-5.205-3 Actions prior to operation of facilities.

The following actions are to be taken by an agency designated by GSA to operate a centralized field reproduction facility prior to operations of such a facility:

(a) The designated agency shall assist the appropriate GSA regional office in the determination of firm space needs, including any special requirements. Space needs will be furnished by the GSA regional Administrative Services Division, Printing and Distribution

Federal Property Management Regulations

§ 101-5.303

Branch, before forwarding it to the Public Buildings Service, GSA, for preparation of final working drawings in the Federal building where the plant is to be located.

(b) Arrangements shall be made by the designated agency, in cooperation with GSA, for the pooling of equipment and the necessary absorption of those employees of affected agencies engaged in duplicating work, as prescribed in § 101-5.203-6.

(c) After coordination with the designated operating agency to obtain its current price schedule, procedures for obtaining service, and billing procedures, GSA will announce the availability of the centralized field reproduction facility in the manner prescribed in 101-5.204-2.

[30 FR 17166, Dec. 31, 1965, as amended at 33 FR 3228, Feb. 21, 1968; 41 FR 46296, Oct. 20, 1976; 56 FR 33875, July 24, 1991]

§ 101-5.205-4 Plant inspections and customer evaluations.

Periodic facility inspections and customer evaluations will be performed jointly by GSA and the designated agency in order to appraise the continuing effectiveness of the centralized facility.

[56 FR 33876, July 24, 1991]

Subpart 101-5.3—Federal Employee Health Services

AUTHORITY: Chapter 865, 60 Stat. 903; 5 U.S.C. 7901.

SOURCE: 30 FR 12883, Oct. 9, 1965, unless otherwise noted.

§ 101-5.300 Scope of subpart.

This subpart 101-5.3 states the objective, guiding principles, criteria, and general procedures in connection with the establishment and operation of Federal employee health services in buildings managed by GSA.

§ 101-5.301 Applicability.

This subpart 101-5.3 is applicable to all Federal agencies which occupy space in or are prospective occupying agencies of a building or group of adjoining buildings managed by GSA.

§ 101-5.302 Objective.

It is the objective of GSA to provide or arrange for appropriate health service programs in all Government-owned and leased buildings, or groups of adjoining buildings, which it manages where the building population warrants, where other Federal medical facilities are not available, and, where the number of the occupying agencies indicating a willingness to participate in such a program on a reimbursable basis makes it financially feasible.

§ 101-5.303 Guiding principles.

The following principles will control the scope of the health services to be provided in keeping with the objective:

(a) Employees who work in groups of 300 or more, counting employees of all departments or agencies who are scheduled to be on duty at one time in the same building or group of buildings in the same locality will constitute the minimum number of employees required to warrant the establishment of a health service of a scope specified in § 101-5.304.

(b) As an exception to paragraph (a) of this section, health services of the scope specified in § 101-5.304 may be provided for employees who work in groups of less than 300 where the employing department or agency determines that working conditions involving unusual health risks warrant such provision.

(c) Treatment and medical care in performance-of-duty cases will be provided to employees as set forth in the Federal Employees' Compensation Act (5 U.S.C. 751 *et seq.*).

(d) Reimbursable costs for providing health services will be based on an operating budget which is a summary of all costs required to operate the health service. The reimbursement cost is prorated to participating agencies by means of a per capital formula computed by dividing the operating budget of the health service by the total number of employees sponsored for service. The size of the Federal population served, the compensation of the employees of the health unit, and other factors of medical economics prevalent in the area are factors which affect the local reimbursement cost. Further, in appropriate cases where more than one

§ 101-5.304

41 CFR Ch. 101 (7-1-01 Edition)

health unit is servicing employees housed in the same general locality, costs may be equalized by combining the operating budgets of all such units and dividing the total of the operating budgets by the number of employees sponsored. Special industrial conditions or other abnormal health or accident risk environments may increase the per capita cost.

[30 FR 12883, Oct. 9, 1965, as amended at 35 FR 6651, Apr. 25, 1970]

§ 101-5.304 Type of occupational health services.

The type of occupational health services made available to occupying agencies will be as follows:

(a) Emergency diagnosis and first treatment of injury or illness that become necessary during working hours and that are within the competence of the professional staff and facilities of the health service unit, whether or not such injury was sustained by the employee while in the performance of duty or whether or not such illness was caused by his employment. In cases where the necessary first treatment is outside the competence of the health service staff and facilities, conveyance of the employee to a nearby physician or suitable community medical facility may be provided at Government expense at the request of, or on behalf of, the employee.

(b) Preemployment examinations of persons selected for appointment.

(c) Such inservice examinations of employees as the participating agency determines to be necessary, such as voluntary employee health maintenance examinations which agencies may request for selected employees. Such examinations may be offered on a limited formula plan to all participating agencies when the resources of the health service staff and facilities will permit. Alternatively, when agencies are required to limit the cost of an occupational health services program, the provision of inservice examinations may be provided to selected employees of individual agencies and reimbursed on an individual basis.

(d) Administration, in the discretion of the responsible health service unit physician, of treatments and medications

(1) Furnished by the employee and prescribed in writing by his personal physician as reasonably necessary to maintain the employee at work, and

(2) Prescribed by a physician providing medical care in performance-of-duty injury or illness cases under the Federal Employees' Compensation Act.

(e) Preventive services within the competence of the professional staff

(1) To appraise and report work environment health hazards as an aid in preventing and controlling health risks;

(2) To provide health education to encourage employees to maintain personal health; and

(3) To provide specific disease screening examinations and immunizations.

(f) In addition, employees may be referred, upon their request, to private physicians, dentists, and other community health resources.

[30 FR 12883, Oct. 9, 1965, as amended at 35 FR 6651, Apr. 25, 1970]

§ 101-5.305 Agency participation.

At the time the space requirements for a building or a group of adjoining buildings are developed by GSA, the prospective occupying agencies will be canvassed by GSA to determine if they wish to participate in the occupational health services program. Each agency desiring to participate in the program will be requested to furnish GSA with a written commitment, signed by an authorized official, that it is prepared to reimburse GSA, or such other agency as is designated pursuant to § 101-5.105(b), on a yearly per capita basis for each of its employees housed in the building or buildings covered by the program.

§ 101-5.306 Economic feasibility.

(a) The studies by GSA which lead to the development of space requirements and the determinations made as the result thereof will constitute the feasibility studies and the Administrator's determination contemplated by § 101-5.104.

(b) Each determination to provide health services will be governed by the principles stated in § 101-5.303 and will be in consonance with the general standards and guidelines furnished Federal agencies by the Public Health

Federal Property Management Regulations

Pt. 101-6

Service of the Department of Health, Education, and Welfare.

§ 101-5.307 Public Health Service.

(a) The only authorized contact point for assistance of and consultation with the Public Health Service is the Federal Employee Health Programs, Division of Hospitals, Public Health Service, Washington, DC 20201. Other Federal agencies may be designated by the GSA Regional Administrator, pursuant to § 101-5.105(b) to operate occupational health services. Designated agencies should contact the Public Health Service directly on all matters dealing with the establishment and operation of these services.

(b) Public Health Service should be consulted by the designated agency on such matters as types, amounts, and approximate cost of necessary equipment; the scope of the services to be provided if it is affected by the amount of space and number of building occupants; types and amounts of supplies, materials, medicines, etc., which should be stocked; and the approximate cost of personnel staffing in cases where this method of operation is chosen, etc. PHS should also be asked to develop and monitor standards under which each health unit would be operated.

Subparts 101-5.4—101-5.48 [Reserved]

Subpart 101-5.49—Forms, Reports, and Instructions

§ 101-5.4900 Scope of subpart.

This subpart contains forms, reports, and related instructions used in connection with the regulations on centralized services in Federal buildings prescribed in this part 101-5.

[30 FR 4359, Apr. 3, 1965]

PART 101-6—MISCELLANEOUS REGULATIONS

Sec.

101-6.000 Scope of part.

Subpart 101-6.1 [Reserved]

Subpart 101-6.2—Nondiscrimination in Programs Receiving Federal Financial Assistance

- 101-6.201 Scope of subpart.
- 101-6.202 Purpose.
- 101-6.203 Application of subpart.
- 101-6.204 Discrimination prohibited.
 - 101-6.204-1 General.
 - 101-6.204-2 Specific discriminatory actions prohibited.
 - 101-6.204-3 Special programs.
- 101-6.205 Assurances required.
 - 101-6.205-1 General.
 - 101-6.205-2 Continuing State programs.
 - 101-6.205-3 Elementary and secondary schools.
 - 101-6.205-4 Applicability of assurances.
- 101-6.206 Illustrative applications.
- 101-6.207—101-6.208 [Reserved]
- 101-6.209 Compliance information.
 - 101-6.209-1 Cooperation and assistance.
 - 101-6.209-2 Compliance reports.
 - 101-6.209-3 Access to sources of information.
 - 101-6.209-4 Information to beneficiaries and participants.
- 101-6.210 Conduct of investigations.
 - 101-6.210-1 Periodic compliance reviews.
 - 101-6.210-2 Complaints.
 - 101-6.210-3 Investigations.
 - 101-6.210-4 Resolution of matters.
 - 101-6.210-5 Intimidatory or retaliatory acts prohibited.
- 101-6.211 Procedure for effecting compliance.
 - 101-6.211-1 General.
 - 101-6.211-2 Noncompliance with § 101-6.205.
 - 101-6.211-3 Termination of or refusal to grant or to continue Federal financial assistance.
 - 101-6.211-4 Other means authorized by law.
- 101-6.212 Hearings.
 - 101-6.212-1 Opportunity for hearing.
 - 101-6.212-2 Time and place of hearing.
 - 101-6.212-3 Right to counsel.
 - 101-6.212-4 Procedures, evidence, and record.
 - 101-6.212-5 Consolidated or joint hearings.
- 101-6.213 Decisions and notices.
 - 101-6.213-1 Decision by person other than the responsible GSA official.
 - 101-6.213-2 Decisions on record or review by the responsible GSA official.
 - 101-6.213-3 Decisions on record where a hearing is waived.
 - 101-6.213-4 Rulings required.
 - 101-6.213-5 Approval by Administrator.
 - 101-6.213-6 Content of orders.
 - 101-6.213-7 Post termination proceedings.
- 101-6.214 Judicial review.
- 101-6.215 Effect on other regulations; forms and instructions.
 - 101-6.215-1 Effect on other regulations.
 - 101-6.215-2 Forms and instructions.
 - 101-6.215-3 Supervision and coordination.
- 101-6.216 Definitions.

Pt. 101-6

41 CFR Ch. 101 (7-1-01 Edition)

101-6.217 Laws authorizing Federal financial assistance for programs to which this subpart applies.

Subpart 101-6.3—Ridesharing

101-6.300 Federal facility ridesharing—general policy.
101-6.301 Definitions.
101-6.302 Employee transportation coordinators.
101-6.303 Reporting procedures.
101-6.304 Exemptions.
101-6.305 Assistance to agencies.

Subpart 101-6.4—Official Use of Government Passenger Carriers Between Residence and Place of Employment

101-6.400 Cross-reference to the Federal Management Regulation (FMR) (41 CFR chapter 102, parts 102-1 through 102-220).

Subpart 101-6.5—Code of Ethics for Government Service

101-6.500 Scope of subpart.

Subpart 101-6.6—Fire Protection (Firesafety) Engineering

101-6.600 Scope of subpart.
101-6.601 Background.
101-6.602 Application.
101-6.603 Definitions.
101-6.604 Requirements.
101-6.605 Responsibility.

Subparts 101-6.7—101-6.9 [Reserved]

Subpart 101-6.10—Federal Advisory Committee Management

101-6.1001 Scope.
101-6.1002 Policy.
101-6.1003 Definitions.
101-6.1004 Examples of advisory meetings or groups not covered by the Act or this subpart.
101-6.1005 Authorities for establishment of advisory committees.
101-6.1006 [Reserved]
101-6.1007 Agency procedures for establishing advisory committees.
101-6.1008 The role of GSA.
101-6.1009 Responsibilities of an agency head.
101-6.1010 [Reserved]
101-6.1011 Responsibilities of the chairperson of an independent Presidential advisory committee.
101-6.1012 [Reserved]
101-6.1013 Charter filing requirements.
101-6.1014 [Reserved]
101-6.1015 Advisory committee information which must be published in the FEDERAL REGISTER.

101-6.1016 [Reserved]
101-6.1017 Responsibilities of the agency Committee Management Officer.
101-6.1018 [Reserved]
101-6.1019 Duties of the Designated Federal Officer.
101-6.1020 [Reserved]
101-6.1021 Public participation in advisory committee meetings.
101-6.1022 [Reserved]
101-6.1023 Procedures for closing an advisory committee meeting.
101-6.1024 [Reserved]
101-6.1025 Requirement for maintaining minutes of advisory committee meetings.
101-6.1026 [Reserved]
101-6.1027 Termination of advisory committees.
101-6.1028 [Reserved]
101-6.1029 Renewal and rechartering of advisory committees.
101-6.1030 [Reserved]
101-6.1031 Amendments to advisory committee charters.
101-6.1032 [Reserved]
101-6.1033 Compensation and expense reimbursement of advisory committee members, staffs and consultants.
101-6.1034 [Reserved]
101-6.1035 Reports required for advisory committees.

Subparts 101-6.11—101-6.20 [Reserved]

Subpart 101-6.21—Intergovernmental Review of General Services Administration Programs and Activities

101-6.2100 Scope of subpart.
101-6.2101 What is the purpose of these regulations?
101-6.2102 What definitions apply to these regulations?
101-6.2103 What programs and activities of GSA are subject to these regulations?
101-6.2104 What are the Administrator's general responsibilities under the Order?
101-6.2105 What is the Administrator's obligation with respect to Federal inter-agency coordination?
101-6.2106 What procedures apply to the selection of programs and activities under these regulations?
101-6.2107 How does the Administrator communicate with State and local officials concerning GSA's programs and activities?
101-6.2108 How does the Administrator provide States an opportunity to comment on proposed Federal financial assistance and direct Federal development?
101-6.2109 How does the Administrator receive and respond to comments?
101-6.2110 How does the Administrator make efforts to accommodate intergovernmental concerns?

Federal Property Management Regulations

§ 101-6.203

- 101-6.2111 What are the Administrator's obligations in interstate situations?
101-6.2112 How may a State simplify, consolidate, or substitute federally required State plans?
101-6.2113 May the Administrator waive any provision of these regulations?

Subparts 101-6.22—101-6.48 [Reserved]

Subpart 101-6.49—Illustrations

- 101-6.4900 Scope of subpart.
101-6.4901 [Reserved]
101-6.4902 Format of certification required for budget submissions of estimates of obligations in excess of \$100,000 for acquisitions of real and related personal property.

AUTHORITY: 31 U.S.C. 1344(e)(1); 40 U.S.C. 486(c).

§ 101-6.000 Scope of part.

This part sets forth miscellaneous regulations regarding Federal Property Management Regulations matters which do not come within the scope of any other subchapter of chapter 101.

(5 U.S.C. 5724, and E.O. 11012, 27 FR 2983; 3 CFR, 1959-1963 Comp., p. 591)

[29 FR 15972, Dec. 1, 1964]

Subpart 101-6.1 [Reserved]

Subpart 101-6.2—Nondiscrimination in Programs Receiving Federal Financial Assistance

AUTHORITY: Sec. 602, 78 Stat. 252; 42 U.S.C. 2000d-1.

SOURCE: 29 FR 16287, Dec. 4, 1964, unless otherwise noted.

§ 101-6.201 Scope of subpart.

This subpart provides the regulations of the General Services Administration (GSA) under title VI of the Civil Rights Act of 1964 (52 U.S.C. 2000d-2000d-4) concerning nondiscrimination in federally assisted programs in connection with which Federal financial assistance is extended under laws administered in whole or in part by GSA.

[38 FR 17973, July 5, 1973]

§ 101-6.202 Purpose.

The purpose of this subpart is to effectuate the provisions of title VI of the Civil Rights Act of 1964 (hereinafter

referred to as the "Act") to the end that no person in the United States shall, on the ground of race, color, or national origin, be excluded from participation in, be denied the benefits of, or be otherwise subjected to discrimination under any program or activity receiving Federal financial assistance from GSA.

§ 101-6.203 Application of subpart.

(a) Subject to paragraph (b) of this section, this subpart applies to any program for which Federal financial assistance is authorized under a law administered in whole or in part by GSA, including the laws listed in § 101-6.217. It applies to money paid, property transferred, or other Federal financial assistance extended to any such program after the effective date of this subpart pursuant to an application approved prior to such effective date. This subpart does not apply to (1) Any Federal financial assistance by way of insurance or guaranty contracts, (2) money paid, property transferred, or other assistance extended to any such program before the effective date of this subpart, except to the extent otherwise provided by contract, (3) any assistance to any individual who is the ultimate beneficiary under any such program, or (4) any employment practice, under any such program, of any employer, employment agency, or labor organization, except to the extent described in § 101-6.204-2(d). The fact that a statute which authorizes GSA to extend Federal financial assistance to a program or activity is not listed in § 101-6.217 shall not mean, if title VI of the Act is otherwise applicable, that such program is not covered. Other programs involving statutes now in force or hereinafter enacted may be added to this list by notice published in the FEDERAL REGISTER.

(b) The regulations issued by the following Departments pursuant to title VI of the Act shall be applicable to the programs involving Federal financial assistance of the kind indicated, and those Departments shall respectively be responsible for determining and enforcing compliance therewith:

(1) Department of Health, Education, and Welfare—donation or transfer of

surplus property for purposes of education or public health (§101-6.217 (a)(2) and (b)).

(2) Department of Defense—donation of surplus personal property for purposes of civil defense (§101-6.217(a)(2)).

(3) Department of Transportation—donation of property for public airport purposes (§101-6.217(c)). GSA will, however, be responsible for obtaining such assurances as may be required in applications and in instruments effecting the transfer of property.

(4) Department of the Interior—disposal of surplus real property, including improvements, for use as a public park, public recreational area, or historic monument (§101-6.217(d) (1) and (2)). GSA will, however, be responsible for obtaining such assurances as may be required in applications and in instruments effecting the transfer of property for use as a historic monument.

(5) Department of Housing and Urban Development—disposal of surplus real property for use in the provision of rental or cooperative housing to be occupied by families or individuals of low or moderate income (§101-6.217(q)).

(c) Each Department named in paragraph (b) of this section shall keep GSA advised of all compliance and enforcement actions, including sanctions imposed or removed, taken by it with respect to the programs specified in paragraph (b) of this section to which the regulations of such Department apply.

[38 FR 17973, July 5, 1973]

§ 101-6.204 Discrimination prohibited.

§ 101-6.204-1 General.

No person in the United States shall, on the ground of race, color, or national origin, be excluded from participation in, be denied the benefits of, or be otherwise subjected to discrimination under any program to which this subpart applies.

§ 101-6.204-2 Specific discriminatory actions prohibited.

(a)(1) In connection with any program to which this subpart applies, a recipient may not, directly or through contractual or other arrangements, on

the ground of race, color, or national origin:

(i) Deny an individual any service, financial aid, or other benefit provided under the program;

(ii) Provide any service, financial aid, or other benefit to an individual which is different, or is provided in a different manner, from that provided to others under the program;

(iii) Subject an individual to segregation or separate treatment in any matter related to his receipt of any service, financial aid, or other benefit under the program;

(iv) Restrict an individual in any way in the enjoyment of any advantage or privilege enjoyed by others receiving any service, financial aid, or other benefit under the program;

(v) Treat an individual differently from others in determining whether he satisfies any admission, enrollment, quota, eligibility, membership or other requirement or condition which individuals must meet in order to be provided any service, financial aid, or other benefit provided under the program;

(vi) Deny an individual an opportunity to participate in the program through the provision of services or otherwise, or afford him an opportunity to do so which is different from that afforded others under the program (including the opportunity to participate in the program as an employee but only to the extent set forth in paragraph (d) of this §101-6.204-2).

(2) A recipient, in determining the types of services, financial aid, or other benefits, or facilities which will be provided under any such program, or the class of individuals to whom, or the situations in which, such services, financial aid, other benefits, or facilities will be provided under any such program, or the class of individuals to be afforded an opportunity to participate in any such program, may not, directly or through contractual or other arrangements, utilize criteria or methods of administration which have the effect of subjecting individuals to discrimination because of their race, color, or national origin, or have the effect of defeating or substantially impairing accomplishment of the objectives of the

Federal Property Management Regulations

§ 101-6.205-1

program as respect individuals of a particular race, color, or national origin.

(3) In determining the site or location of facilities, an applicant or recipient may not make selections with the purpose or effect of excluding individuals from, denying them the benefits of, or subjecting them to discrimination under any program to which this subpart applies, on the ground of race, color, or national origin or with the purpose or effect of defeating or substantially impairing the accomplishment of the objectives of the Act or this subpart.

(4) This subpart does not prohibit the consideration of race, color, or national origin if the purpose and effect are to remove or overcome the consequences of practices or impediments which have restricted the availability of, or participation in, the program or activity receiving Federal financial assistance, on the ground of race, color, or national origin. Where previous discriminatory practice or usage tends, on the ground of race, color, or national origin, to exclude individuals from participation in, to deny them the benefits of, or to subject them to discrimination under any program or activity to which this subpart applies, the applicant or recipient has an obligation to take reasonable action to remove or overcome the consequences of the prior discriminatory practice or usage, and to accomplish the purposes of the Act.

(b) As used in this §101-6.204-2 the services, financial aid, or other benefits provided under a program receiving Federal financial assistance shall be deemed to include any service, financial aid, or other benefit provided in or through a facility provided with the aid of Federal financial assistance.

(c) The enumeration of specific forms of prohibited discrimination in this §101-6.204-2 does not limit the generality of the prohibition in §101-6.204-1.

(d)(1) Where a primary objective of the Federal financial assistance to a program to which this subpart applies is to provide employment, a recipient may not, directly or through contractual or other arrangements, subject an individual to discrimination on the ground of race, color, or national origin in its employment practices under

such program (including, but not limited to, recruitment or recruitment advertising; employment; layoff or termination; upgrading, demotion, or transfer; rates of pay or other forms of compensation; selection for training, including apprenticeship; and use of facilities). The requirements applicable to construction employment under any such program shall be those specified in or pursuant to part III of Executive Order 11246 or the corresponding provisions of any Executive order which supersedes it.

(2) Where a primary objective of the Federal financial assistance is not to provide employment, but discrimination on the ground of race, color, or national origin in the employment practices of the recipient or other persons subject to this subpart tends, on the ground of race, color, or national origin, to exclude individuals from participation in, to deny them the benefits of, or to subject them to discrimination under any program to which this subpart applies, the provisions of paragraph (d)(1) of this section shall apply to the employment practices of the recipient or other persons subject to this subpart, to the extent necessary to insure equality of opportunity to, and nondiscriminatory treatment of, beneficiaries.

[29 FR 16287, Dec. 4, 1964, as amended at 38 FR 17973, July 5, 1973]

§ 101-6.204-3 Special programs.

An individual shall not be deemed subjected to discrimination by reason of his exclusion from the benefits of a program limited by Federal law to individuals of a particular race, color, or national origin different from his.

§ 101-6.205 Assurances required.

§ 101-6.205-1 General.

(a) Every application for Federal financial assistance to carry out a program to which this subpart 101-6.2 applies, except a program to which §101-6.205-2 applies, and every application for Federal financial assistance to provide a facility shall, as a condition to its approval and the extension of any Federal financial assistance pursuant to the application, contain or be accompanied by an assurance that the

program will be conducted or the facility operated in compliance with all requirements imposed by or pursuant to this subpart 101-6.2. In the case of an application for Federal financial assistance to provide real property or structures thereon, the assurance shall obligate the recipient, or, in the case of a subsequent transfer, the transferee, for the period during which the real property or structures are used for a purpose for which the Federal financial assistance is extended or for another purpose involving the provision of similar services or benefits. In the case of personal property, the assurance shall obligate the recipient for the period during which he retains ownership or possession of the property. In all other cases the assurance shall obligate the recipient for the period during which Federal financial assistance is extended pursuant to the application. The responsible GSA official shall specify the form of the foregoing assurances for each program and the extent to which like assurances will be required of subgrantees, contractors and subcontractors, transferees, successors in interest, and other participants in the program. Any such assurance shall include provisions which give the United States a right to seek its judicial enforcement.

(b) In the case of real property, structures or improvements thereon, or interests therein, which is acquired with Federal financial assistance, or in the case where Federal financial assistance is provided in the form of a transfer of real property or interest therein from the Federal Government, the instrument effecting or recording the transfer shall contain a covenant running with the land assuring nondiscrimination for the period during which the real property is used for a purpose for which the Federal financial assistance is extended or for another purpose involving the provision of similar services or benefits. Where no transfer of property is involved, but property is improved under a program of Federal financial assistance, the recipient shall agree to include such a covenant in any subsequent transfer of such property. Where the property is obtained from the Federal Government, such covenant may also include a condition

coupled with a right to be reserved by GSA to revert title to the property in the event of a breach of the covenant where, in the discretion of the responsible GSA official, such a condition and right of reverter is appropriate to the program under which the real property is obtained and to the nature of the grant and the grantee. In such event, if a transferee of real property proposes to mortgage or otherwise encumber the real property as security for financing construction of new, or improvement of existing, facilities on such property for the purposes for which the property was transferred, the Administrator may agree, upon request of the transferee and if necessary to accomplish such financing, and upon such conditions as he deems appropriate, to forebear the exercise of such right to revert title for so long as the lien of such mortgage or other encumbrance remains effective.

(c) The assurance required in the case of a transfer of personal property shall be inserted in the instrument effecting the transfer of the property.

(d) In the case of programs not involving a transfer of property, the assurance required shall be inserted in the agreement executed between the United States and the recipient covering the extension of Federal financial assistance.

[29 FR 16287, Dec. 4, 1964, as amended at 38 FR 17973, July 5, 1973]

§ 101-6.205-2 Continuing State programs.

Every application by a State or a State agency to carry out a program involving continuing Federal financial assistance to which this subpart applies shall as a condition to its approval and the extension of any Federal financial assistance pursuant to the application (a) contain or be accompanied by a statement that the program is (or, in the case of a new program, will be) conducted in compliance with all requirements imposed by or pursuant to this subpart, and (b) provide or be accompanied by provision for such methods of administration for the program as are found by the responsible GSA official to give reasonable assurance that the applicant and

Federal Property Management Regulations

§ 101-6.206

all recipients of Federal financial assistance under such program will comply with all requirements imposed by or pursuant to this subpart.

[38 FR 17974, July 5, 1973]

§ 101-6.205-3 Elementary and secondary schools.

The requirements of §§ 101-6.205-1 and 101-6.205-2 with respect to any elementary or secondary school or school system shall be deemed to be satisfied if such school or school system (a) Is subject to a final order of a court of the United States for the desegregation of such school or school system, and provides an assurance that it will comply with such order, including any future modification of such order, or (b) submits a plan for the desegregation of such school or school system which the responsible official of the Department of Health, Education, and Welfare determines is adequate to accomplish the purposes of the Act and this subpart within the earliest practicable time, and provides reasonable assurance that it will carry out such plan. In any case of continuing Federal financial assistance such responsible official may reserve the right to redetermine, after such period as may be specified by him, the adequacy of the plan to accomplish the purposes of the Act and this subpart. In any case in which a final order of a court of the United States for the desegregation of such school or school system is entered after submission of such a plan, such plan shall be revised to conform to such final order, including any future modification of such order.

[38 FR 17974, July 5, 1973]

§ 101-6.205-4 Applicability of assurances.

(a) In the case of any application for Federal financial assistance to an institution of higher education, the assurance required by this § 101-6.205 shall extend to admission practices and to all other practices relating to the treatment of students.

(b) The assurance required with respect to an institution of higher education, hospital, or any other institution, insofar as the assurance relates to the institution's practices with respect

to admission or other treatment of individuals as students, patients, or clients of the institution or to the opportunity to participate in the provision of services or other benefits to such individuals, shall be applicable to the entire institution unless the applicant establishes, to the satisfaction of the responsible GSA official, that the institution's practices in designated parts or programs of the institution will in no way affect its practices in the program of the institution for which Federal financial assistance is sought, or the beneficiaries of or participants in such program. If in any such case the assistance sought is for the construction of a facility or part of a facility, the assurance shall in any event extend to the entire facility and to facilities operated in connection therewith.

(c) Where an installation or facility (for example, a public airport, or park or recreation area) is comprised of real property for which application is made under a program, and, in addition, other real property of the applicant, the assurance required under this § 101-6.205 shall be applicable to the entire installation or facility.

§ 101-6.206 Illustrative applications.

The following examples will illustrate the application of the foregoing provisions of this subpart to certain programs for which Federal financial assistance is extended by GSA (in all cases the discrimination prohibited is discrimination on the ground of race, color, or national origin, prohibited by title VI of the Act and this subpart):

(a) In the programs involving the transfer of surplus property for airport, park or recreation, historic monument, wildlife conservation, or street widening purposes (§ 101-6.217(c), (d), (e), and (h)), the public generally is entitled to the use of the facility and to receive the services provided by the facility and to facilities operated in connection therewith, without segregation or any other discriminatory practices.

(b) In the program involving the loan of machine tools to nonprofit institutions or training schools (§ 101-6.217(o)), discrimination by the recipient in the admission of students or trainees or in the treatment of its students or trainees in any aspect of the educational

process is prohibited. In the case of an institution of higher education, the prohibition applies to the entire institution except as provided in paragraph (b) of §101-6.205-4. In the case of elementary or secondary schools, the prohibition applies to all elementary and secondary schools of the recipient school district, consistent with §101-6.205-3. In this and other illustrations the prohibition of discrimination in the treatment of students or trainees includes the prohibition of discrimination among the students or trainees in the availability or use of any academic, dormitory, eating, recreational, or other facilities of the recipient.

(c) In the programs involving the donation of personal property to public bodies or the American National Red Cross (§101-6.217 (f) and (j)), discrimination in the selection or treatment of individuals to receive or receiving the benefits or services of the program is prohibited.

(d) In the program involving the donation of personal property to eleemosynary institutions (§101-6.217(I)), the assurance will apply to applicants for admission, patients, interns, residents, student nurses, and other trainees, and to the privilege of physicians, dentists, and other professionally qualified persons to practice in the institution, and will apply to the entire institution and to facilities operated in connection therewith, subject to the provisions of §101-6.205-4(b).

(e) In the programs involving the allotment of space by GSA to Federal Credit Unions, without charge for rent or services, and the provision of free space and utilities for vending stands operated by blind persons (§101-6.217 (i) and (k)), discrimination by segregation or otherwise in providing benefits or services is prohibited.

(f) In the program involving grants to State and local agencies and to non-profit organizations and institutions for the collecting, describing, preserving, and compiling and publishing of documentary sources significant to the history of the United States (§101-6.217(n)), discrimination by the recipient in the selection of students or other participants in the program, and, with respect to educational institu-

tions, in the admission or treatment of students, is prohibited.

(g) In the program involving the transfer of surplus real property for use in the provision of rental or cooperative housing to families or individuals of low or moderate income (§101-6.217(q)), discrimination in the selection and assignment of tenants is prohibited.

(h) A recipient may not take action that is calculated to bring about indirectly what this subpart forbids it to accomplish directly.

(i) In some situations even though past discriminatory practices have been abandoned, the consequences of such practices continue to impede the full availability of a benefit. If the efforts required of the applicant or recipient under §101-6.209-4 to provide information as to the availability of the program or activity and the rights of beneficiaries under this subpart have failed to overcome these consequences, it will become necessary for such applicant or recipient to take additional steps to make the benefits fully available to racial and nationality groups previously subjected to discrimination. This action might take the form, for example, of special arrangements for obtaining referrals or making selections which will ensure that groups previously subjected to discrimination are adequately served.

(j) Even though an applicant or recipient has never used discriminatory policies, the services and benefits of the program or activity it administers may not in fact be equally available to some racial or nationality groups. In such circumstances, an applicant or recipient may properly give special consideration to race, color, or national origin to make the benefits of its program more widely available to such groups not then being adequately served. For example, where a university is not adequately serving members of a particular racial or nationality group, it may establish special recruitment policies to make its program better known and more readily available to such group, and take other steps to provide that group with more adequate service.

[29 FR 16287, Dec. 4, 1964, as amended at 38 FR 17974, July 5, 1973]

Federal Property Management Regulations

§ 101-6.210-4

§§ 101-6.207—101-6.208 [Reserved]

§ 101-6.209 Compliance information.

§ 101-6.209-1 Cooperation and assistance.

Each responsible GSA official shall to the fullest extent practicable seek the cooperation of recipients in obtaining compliance with this subpart 101-6.2 and shall provide assistance and guidance to recipients to help them comply voluntarily with this subpart.

§ 101-6.209-2 Compliance reports.

Each recipient shall keep such records and submit to the responsible GSA official or his designee timely, complete and accurate compliance reports at such times, and in such form and containing such information, as the responsible GSA official or his designee may determine to be necessary to enable him to ascertain whether the recipient has complied or is complying with this subpart 101-6.2. In the case of any program under which a primary recipient extends Federal financial assistance to any other recipient, such other recipient shall also submit such compliance reports to the primary recipient as may be necessary to enable the primary recipient to carry out its obligations under this subpart.

§ 101-6.209-3 Access to sources of information.

Each recipient shall permit access by the responsible GSA official or his designee during normal business hours to such of its books, records, accounts, and other sources of information, and its facilities as may be pertinent to ascertain compliance with this subpart. Where any information required of a recipient is in the exclusive possession of any other agency, institution or person and this agency, institution or person shall fail or refuse to furnish this information, the recipient shall so certify in its report and shall set forth what efforts it has made to obtain the information.

§ 101-6.209-4 Information to beneficiaries and participants.

Each recipient shall make available to participants, beneficiaries, and other interested persons such informa-

tion regarding the provisions of this subpart 101-6.2 and its applicability to the program under which the recipient receives Federal financial assistance, and make such information available to them in such manner, as the responsible GSA official finds necessary to apprise such persons of the protections against discrimination assured them by the Act and this subpart 101-6.2.

§ 101-6.210 Conduct of investigations.

§ 101-6.210-1 Periodic compliance reviews.

The responsible GSA official or his designee shall from time to time review the practices of recipients to determine whether they are complying with this regulation.

§ 101-6.210-2 Complaints.

Any person who believes himself or any specific class of individuals to be subjected to discrimination prohibited by this subpart 101-6.2 may by himself or by a representative file with the responsible GSA official or his designee a written complaint. A complaint must be filed not later than 90 days from the date of the alleged discrimination, unless the time for filing is extended by the responsible GSA official or his designee.

§ 101-6.210-3 Investigations.

The responsible GSA official or his designee will make a prompt investigation whenever a compliance review, report, complaint, or any other information indicates a possible failure to comply with this subpart 101-6.2. The investigation should include, where appropriate, a review of the pertinent practices and policies of the recipient, the circumstances under which the possible noncompliance with this subpart occurred, and other factors relevant to a determination as to whether the recipient has failed to comply with this subpart.

§ 101-6.210-4 Resolution of matters.

(a) If an investigation pursuant to § 101-6.210-3 indicates a failure to comply with this subpart 101-6.2, the responsible GSA official or his designee will so inform the recipient and the matter will be resolved by informal

§ 101-6.210-5

means whenever possible. If it has been determined that the matter cannot be resolved by informal means, action will be taken as provided for in §101-6.211.

(b) If an investigation does not warrant action pursuant to paragraph (a) of this section the responsible GSA official or his designee will so inform the recipient and the complainant, if any, in writing.

§ 101-6.210-5 Intimidatory or retaliatory acts prohibited.

No recipient or other person shall intimidate, threaten, coerce, or discriminate against any individual for the purpose of interfering with any right or privilege secured by section 601 of the Act or this subpart 101-6.2, or because he has made a complaint, testified, assisted or participated in any manner in an investigation, proceeding, or hearing under this subpart. The identity of complainants shall be kept confidential except to the extent necessary to carry out the purposes of this subpart, including the conduct of any investigation, hearing, or judicial proceeding arising thereunder.

§ 101-6.211 Procedure for effecting compliance.

§ 101-6.211-1 General.

If there appears to be a failure or threatened failure to comply with this subpart 101-6.2, and if the noncompliance or threatened noncompliance cannot be corrected by informal means, compliance with this subpart may be effected by the suspension or termination of or refusal to grant or to continue Federal financial assistance or by any other means authorized by law. Such other means may include, but are not limited to, (a) a reference to the Department of Justice with a recommendation that appropriate proceedings be brought to enforce any rights of the United States under any law of the United States (including other titles of the Act), or any assurance or other contractual undertaking, and (b) any applicable proceeding under State or local law.

41 CFR Ch. 101 (7-1-01 Edition)

§ 101-6.211-2 Noncompliance with § 101-6.205.

If an applicant fails or refuses to furnish an assurance required under §101-6.205 or otherwise fails or refuses to comply with a requirement imposed by or pursuant to that section Federal financial assistance may be refused in accordance with the procedures of §101-6.211-3. The GSA shall not be required to provide assistance in such a case during the pendency of the administrative proceedings under §101-6.211-3 except that GSA shall continue assistance during the pendency of such proceedings where such assistance is due and payable pursuant to an application therefor approved prior to the effective date of this subpart 101-6.2.

§ 101-6.211-3 Termination of or refusal to grant or to continue Federal financial assistance.

No order suspending, terminating or refusing to grant or continue Federal financial assistance shall become effective until (a) the responsible GSA official has advised the applicant or recipient of his failure to comply and has determined that compliance cannot be secured by voluntary means, (b) there has been an express finding on the record, after opportunity for hearing, of a failure by the applicant or recipient to comply with a requirement imposed by or pursuant to this subpart 101-6.2, (c) the action has been approved by the Administrator pursuant to §101-6.213-5, and (d) the expiration of 30 days after the Administrator has filed with the committee of the House and the committee of the Senate having legislative jurisdiction over the program involved, a full written report of the circumstances and the grounds for such action. Any action to suspend or terminate or to refuse to grant or to continue Federal financial assistance shall be limited to the particular political entity, or part thereof, or other applicant or recipient as to whom such a finding has been made and shall be limited in its effect to the particular program, or part thereof, in which such noncompliance has been so found.

Federal Property Management Regulations

§ 101-6.212-4

§ 101-6.211-4 Other means authorized by law.

No action to effect compliance by an other means authorized by law shall be taken until (a) the responsible GSA official has determined that compliance cannot be secured by voluntary means, (b) the recipient or other person has been notified of his failure to comply and of the action to be taken to effect compliance, and (c) the expiration of at least 10 days from the mailing of such notice to the recipient or other person. During this period of at least 10 days, additional efforts shall be made to persuade the recipient or other person to comply with this subpart and to take such corrective action as may be appropriate.

[38 FR 17974, July 5, 1973]

§ 101-6.212 Hearings.

§ 101-6.212-1 Opportunity for hearing.

Whenever an opportunity for a hearing is required by § 101-6.211-3, reasonable notice shall be given by registered or certified mail, return receipt requested, to the affected applicant or recipient. This notice shall advise the applicant or recipient of the action proposed to be taken, the specific provision under which the proposed action against it is to be taken, and the matters of fact or law asserted as the basis for this action, and either:

(a) Fix a date not less than 20 days after the date of such notice within which the applicant or recipient may request of the responsible GSA official that the matter be scheduled for hearing, or (b) advise the applicant or recipient that the matter in question has been set down for hearing at a stated place and time. The time and place so fixed shall be reasonable and shall be subject to change for cause. The complainant, if any, shall be advised of the time and place of the hearing. An applicant or recipient may waive a hearing and submit written information and argument for the record. The failure of an applicant or recipient to request a hearing under this section or to appear at a hearing for which a date has been set shall be deemed to be a waiver of the right to a hearing under section 602 of the Act and § 101-6.211-3, and consent to the making of a deci-

sion on the basis of such information as is available.

(b) [Reserved]

§ 101-6.212-2 Time and place of hearing.

Hearings shall be held, at a time fixed by the responsible GSA official, at the offices of GSA in Washington, DC, unless such official determines that the convenience of the applicant or recipient or of GSA requires that another place be selected. Hearings shall be held before the responsible GSA official or, at his discretion, before a hearing examiner designated in accordance with 5 U.S.C. 3105 or 3344 (section 11 of the Administrative Procedure Act).

[38 FR 17974, July 5, 1973]

§ 101-6.212-3 Right to counsel.

In all proceedings under this § 101-6.212 the applicant or recipient and GSA shall have the right to be represented by counsel.

§ 101-6.212-4 Procedures, evidence, and record.

(a) The hearing, decision, and any administrative review thereof shall be conducted in conformity with 5 U.S.C. 554-557 (sections 5-8 of the Administrative Procedure Act) and in accordance with such rules of procedure as are proper (and not inconsistent with this section) relating to the conduct of the hearing, giving of notices subsequent to those provided for in § 101-6.212-1, taking of testimony, exhibits, arguments and briefs, requests for findings, and other related matters. Both GSA and the applicant or recipient shall be entitled to introduce all relevant evidence on the issues as stated in the notice for hearing or as determined by the officer conducting the hearing at the outset of or during the hearing.

(b) Technical rules of evidence shall not apply to hearings conducted pursuant to this subpart 101-6.2, but rules or principles designed to assure production of the most credible evidence available and to subject testimony to test by cross-examination shall be applied where reasonably necessary by the officer conducting the hearing. The hearing officer may exclude irrelevant,

§ 101-6.212-5

immaterial, or unduly repetitious evidence. All documents and other evidence offered or taken for the record shall be open to examination by the parties and opportunity shall be given to refute facts and arguments advanced on either side of the issues. A transcript shall be made of the oral evidence except to the extent the substance thereof is stipulated for the record. All decisions shall be based upon the hearing record and written findings shall be made.

[29 FR 16287, Dec. 4, 1964, as amended at 38 FR 17974, July 5, 1973]

§ 101-6.212-5 Consolidated or joint hearings.

In cases in which the same or related facts are asserted to constitute non-compliance with this subpart 101-6.2 with respect to two or more programs to which this subpart applies, or non-compliance with this subpart and the regulations of one or more other Federal departments or agencies issued under title VI of the Act, the Administrator may, by agreement with such other departments, or agencies, where applicable, provide for the conduct of consolidated or joint hearings, and for the application to such hearings of rules of procedure not inconsistent with this regulation. Final decisions in such cases, insofar as this subpart is concerned, shall be made in accordance with § 101-6.213.

§ 101-6.213 Decisions and notices.

§ 101-6.213-1 Decision by person other than the responsible GSA official.

If the hearing is held by a hearing examiner such hearing examiner shall either make an initial decision, if so authorized, or certify the entire record including his recommended findings and proposed decision to the responsible GSA official for a final decision, and a copy of such initial decision or certification shall be mailed to the applicant or recipient. Where the initial decision is made by the hearing examiner the applicant or recipient may within 30 days of the mailing of such notice of initial decision file with the responsible GSA official his exceptions to the initial decision, with his reasons therefor. In the absence of exceptions,

41 CFR Ch. 101 (7-1-01 Edition)

the responsible GSA official may on his own motion within 45 days after the initial decision serve on the applicant or recipient a notice that he will review the decision. Upon the filing of such exceptions or of such notice of review the responsible GSA official shall review the initial decision and issue his own decision thereon including the reasons therefor. In the absence of either exceptions or a notice of review the initial decision shall constitute the final decision of the responsible GSA official.

§ 101-6.213-2 Decisions on record or review by the responsible GSA official.

Whenever a record is certified to the responsible GSA official for decision or he reviews the decision of a hearing examiner pursuant to § 101-6.213-1, or whenever the responsible GSA official conducts the hearing, the applicant or recipient shall be given reasonable opportunity to file with him briefs or other written statements of its contentions, and a copy of the final decision of the responsible GSA official shall be given in writing to the applicant or recipient, and to the complainant, if any.

§ 101-6.213-3 Decisions on record where a hearing is waived.

Whenever a hearing is waived pursuant to § 101-6.212 a decision shall be made by the responsible GSA official on the record and a copy of such decision shall be given in writing to the applicant or recipient, and to the complainant, if any.

§ 101-6.213-4 Rulings required.

Each decision of a hearing officer or responsible GSA official shall set forth his ruling on each finding, conclusion, or exception presented, and shall identify the requirement or requirements imposed by or pursuant to this subpart 101-6.2 with which it is found that the applicant or recipient has failed to comply.

§ 101-6.213-5 Approval by Administrator.

Any final decision of a responsible GSA official (other than the Administrator) which provides for the suspension or termination of, or the refusal to

Federal Property Management Regulations

§ 101-6.215-1

grant or continue Federal financial assistance, or the imposition of any other sanction available under this subpart 101-6.2 or the Act, shall promptly be transmitted to the Administrator, who may approve such decision, may vacate it, or remit or mitigate any sanction imposed.

§ 101-6.213-6 Content of orders.

The final decision may provide for suspension or termination of, or refusal to grant or continue Federal financial assistance, in whole or in part, under the program involved, and may contain such terms, conditions, and other provisions as are consistent with and will effectuate the purposes of the Act and this subpart 101-6.2, including provisions designed to assure that no Federal financial assistance will thereafter be extended under such program to the applicant or recipient determined by such decision to be in default in its performance of an assurance given by it pursuant to this subpart, or to have otherwise failed to comply with this subpart, unless and until it corrects its noncompliance and satisfies the responsible GSA official that it will fully comply with this subpart.

§ 101-6.213-7 Post termination proceedings.

(a) An applicant or recipient adversely affected by an order issued under § 101-6.213-6 shall be restored to full eligibility to receive Federal financial assistance if it satisfies the terms and conditions of that order for such eligibility or if it brings itself into compliance with this subpart and provides reasonable assurance that it will fully comply with this subpart. An elementary or secondary school or school system which is unable to file an assurance of compliance with § 101-6.24 shall be restored to full eligibility to receive financial assistance if it files a court order or a plan for desegregation meeting the requirements of § 101-6.205-3 and provides reasonable assurance that it will comply with this court order or plan.

(b) Any applicant or recipient adversely affected by an order entered pursuant to § 101-6.213-6 may at any time request the responsible GSA official to restore fully its eligibility to re-

ceive Federal financial assistance. Any such request shall be supported by information showing that the applicant or recipient has met the requirements of paragraph (a) of this section. If the responsible GSA official determines that those requirements have been satisfied, he shall restore such eligibility.

(c) If the responsible GSA official denies any such request, the applicant or recipient may submit a request, in writing, for a hearing, specifying why it believes such official to have been in error. It shall thereupon be given an expeditious hearing, with a decision on the record, in accordance with rules of procedure issued by the responsible GSA official. The applicant or recipient will be restored to such eligibility if it proves at such a hearing that it satisfied the requirements of paragraph (a) of this section. While proceedings under this section are pending, the sanctions imposed by the order issued under § 101-6.213-6 shall remain in effect.

[38 FR 17975, July 5, 1973]

§ 101-6.214 Judicial review.

Action taken pursuant to section 602 of the Act is subject to judicial review as provided in section 603 of the Act.

§ 101-6.215 Effect on other regulations; forms and instructions.

§ 101-6.215-1 Effect on other regulations.

All regulations, orders, or like directions heretofore issued by any officer of GSA which imposed requirements designed to prohibit any discrimination against individuals on the ground of race, color, or national origin under any program to which this subpart 101-6.2 applies, and which authorize the suspension or termination of or refusal to grant or to continue Federal financial assistance to any applicant for or recipient of such assistance under such program for failure to comply with such requirements, are hereby superseded to the extent that such discrimination is prohibited by this subpart, except that nothing in this subpart shall be deemed to relieve any person of any obligation assumed or imposed under any such superseded regulation, order, instruction, or like direction

§ 101-6.215-2

41 CFR Ch. 101 (7-1-01 Edition)

prior to the effective date of this subpart. Nothing in this subpart, however, shall be deemed to supersede any of the following (including future amendments thereof):

(a) Executive Orders 10925, 11114, and 11246, and regulations issued thereunder.

(b) Any other orders, regulations, or instructions, insofar as such orders, regulations, or instructions prohibit discrimination on the ground of race, color, or national origin in any program or situation to which this subpart is inapplicable, or prohibit discrimination on any other ground.

[29 FR 16287, Dec. 4, 1964, as amended at 38 FR 17975, July 5, 1973]

§ 101-6.215-2 Forms and instructions.

Each responsible GSA official shall issue and promptly make available to interested persons forms and detailed instructions and procedures for effectuating this subpart 101-6.2 as applied to programs to which this subpart applies and for which he is responsible.

§ 101-6.215-3 Supervision and coordination.

The Administrator may from time to time assign to officials of other departments or agencies of the Government, with the consent of such departments or agencies, responsibilities in connection with the effectuation of the purposes of title VI of the Act and this subpart (other than responsibility for final decision as provided in § 101-6.213), including the achievement of effective coordination and maximum uniformity within GSA and within the executive branch of the Government in the application of title VI and this subpart to similar programs and in similar situations. Any action taken, determination made, or requirement imposed by an official of another Department or Agency acting pursuant to an assignment of responsibility under this section shall have the same effect as though such action had been taken by the responsible GSA official.

[38 FR 17975, July 5, 1973]

§ 101-6.216 Definitions.

As used in this subpart:

(a) The term *General Services Administration* or *GSA* includes each of its operating services and other organizational units.

(b) The term *Administrator* means the Administrator of General Services.

(c) The term *responsible GSA official* with respect to any program receiving Federal financial assistance means the Administrator or other official of GSA who by law or by delegation has the principal responsibility within GSA for the administration of the law extending such assistance.

(d) The term *United States* means the States of the United States, the District of Columbia, Puerto Rico, the Virgin Islands, American Samoa, Guam, Wake Island, the Canal Zone, and the territories and possessions of the United States, and the terms *State* means any one of the foregoing.

(e) The term *Federal financial assistance* includes (1) grants and loans of Federal funds, (2) the grant or donation of Federal property and interests in property, (3) the detail of Federal personnel, (4) the sale and lease of, and the permission to use (on other than a casual or transient basis), Federal property or any interest in such property without consideration or at a nominal consideration, or at a consideration which is reduced for the purposes of assisting the recipient, or in recognition of the public interest to be served by such sale or lease to the recipient, and (5) any Federal agreement, arrangement, or other contract which has as one of its purposes the provision of assistance.

(f) The term *program* includes any program, project, or activity for the provision of services, financial aid, or other benefits to individuals (including education or training, health, welfare, rehabilitation, housing, or other services, whether provided through employees of the recipient of Federal financial assistance or provided by others through contracts or other arrangements with the recipient, and including work opportunities and cash or loan or other assistance to individuals), or for the provision of facilities for furnishing services, financial aid or other benefits to individuals. The services, financial aid, or other benefits provided

Federal Property Management Regulations

§ 101-6.217

under a program receiving. Federal financial assistance shall be deemed to include any services, financial aid, or other benefits provided with the aid of Federal financial assistance or with the aid of any non-Federal funds, property, or other resources required to be expended or made available for the program to meet matching requirements or other conditions which must be met in order to receive the Federal financial assistance, and to include any services, financial aid, or other benefits provided in or through a facility provided with the aid of Federal financial assistance or such non-Federal resources.

(g) The term *facility* includes all or any portion of structures, equipment, or other real or personal property or interests therein, and the provision of facilities includes the construction, expansion, renovation, remodeling, alteration or acquisition of facilities.

(h) The term *recipient* means any State, political subdivision of any State, or instrumentality of any State or political subdivision, any public or private agency, institution, or organization, or any other entity, or any individual, in any State, to whom Federal financial assistance is extended, directly or through another recipient, for any program, including any successor, assign, or transferee thereof, but such term does not include any ultimate beneficiary under any such program.

(i) The term *primary recipient* means any recipient which is authorized or required to extend Federal financial assistance to another recipient for the purpose of carrying out a program.

(j) The term *applicant* means one who submits an application, request, or plan required to be approved by a responsible GSA official, or by a primary recipient, as a condition to eligibility for Federal financial assistance, and the term *application* means such an application, request, or plan.

§ 101-6.217 Laws authorizing Federal financial assistance for programs to which this subpart applies.

(a)(1) Donation of surplus personal property to educational activities which are of special interest to the armed services (section 203(j)(2) of the

Federal Property and Administrative Services Act of 1949, 40 U.S.C. 484(j)(2)).

(2) Donation of surplus personal property for use in any State for purposes of education, public health, or civil defense, or for research for any such purposes (section 203(j) (3) and (4) of the Federal Property and Administrative Services Act of 1949, 40 U.S.C. 484(j) (3) and (4)), and the making available to State agencies for surplus property, or the transfer of title to such agencies, of surplus personal property approved for donation for purposes of education, public health, or civil defense, or for research for any such purposes (section 203(n) of the Federal Property and Administrative Services Act of 1949, 40 U.S.C. 484(n)).

(b) Disposal of surplus real and related personal property for purposes of education or public health, including research (section 203(k)(1) of the Federal Property and Administrative Services Act of 1949, 40 U.S.C. 484(k)(1)).

(c) Donation of property for public airport purposes (section 13(g) of the Surplus Property Act of 1944, 50 U.S.C. App. 1622(g); section 23 of the Airport and Airway Development Act of 1970, Pub. L. 91-258).

(d)(1) Disposal of surplus real property, including improvements, for use as a historic monument (section 13(h) of the Surplus Property Act of 1944, 50 U.S.C. App. 1622(h)).

(2) Disposal of surplus real and related personal property for public park or public recreational purposes (section 203(k)(2) of the Federal Property and Administrative Services Act of 1949, 40 U.S.C. 484(k)(2)).

(e) Disposal of real property to States for wildlife conservation purposes (Act of May 19, 1948, 16 U.S.C. 667b-d).

(f) Donation of personal property to public bodies (section 202(h) of the Federal Property and Administrative Services Act of 1949, 40 U.S.C. 483(h)).

(g) Grants of easements by the General Services Administration pursuant to the Act of October 23, 1962, (40 U.S.C. 319-319(c), and grants by the General Services Administration of revocable licenses or permits to use or occupy Federal real property, if the consideration to the Government for such easement, licenses, or permits is less than estimated fair market value.

§ 101-6.300

(h) Conveyance of real property or interests therein by the General Services Administration to States or political subdivisions for street widening purposes pursuant to the Act of July 7, 1960 (40 U.S.C. 345c), if the consideration to the Government is less than estimated fair market value.

(i) Allotment of space by the General Services Administration in Federal buildings to Federal Credit Unions, without charge for rent or services (section 25 of the Federal Credit Union Act, 12 U.S.C. 1770).

(j) Donation of surplus property to the American National Red Cross (section 203(l) of the Federal Property and Administrative Services Act of 1949, 40 U.S.C. 484(l)).

(k) Provision by the General Services Administration of free space and utilities for vending stands operated by blind persons (section 1 of the Randolph-Sheppard Act, 20 U.S.C. 107).

(l) Donation of forfeited distilled spirits, wine, and malt beverages to eleemosynary institutions (26 U.S.C. 5688).

(m) Donation of surplus Federal records (Federal Records Disposal Act of 1943, 44 U.S.C. 366-380).

(n) Grants to State and local agencies and to nonprofit organizations and institutions for the collecting, describing, preserving and compiling, and publishing of documentary sources significant to the history of the United States (section 503 of the Federal Property and Administrative Services Act of 1949, as amended by Pub. L. 88-383).

(o) Loan of machine tools and industrial manufacturing equipment in the national industrial reserve to nonprofit educational institutions or training schools (section 7 of the National Industrial Reserve Act of 1948, 50 U.S.C. 456).

(p) District of Columbia grant-in-aid hospital program (60 Stat. 896, as amended).

(q) Disposal of surplus real property for use in the provision of rental or cooperative housing to be occupied by families or individuals of low or moderate income (section 414 of the Housing and Urban Development Act of 1969, Pub. L. 91-152).

(r) Payments in lieu of taxes on certain real property transferred from the

41 CFR Ch. 101 (7-1-01 Edition)

Reconstruction Finance Corporation (Title VII of the Federal Property and Administrative Services Act of 1949, 40 U.S.C. 521-524).

(s) Conveyance of certain lands and property to the State of Hawaii without reimbursement (Pub. L. 88-233, 77 Stat. 472).

[29 FR 16287, Dec. 4, 1964, as amended at 38 FR 17975, July 5, 1973]

Subpart 101-6.3—Ridesharing

AUTHORITY: Sec. 205(c), 63 Stat. 390; 40 U.S.C. 486(c), Executive Order 12191 dated February 1, 1980.

SOURCE: 49 FR 20289, May 14, 1984, unless otherwise noted.

§ 101-6.300 Federal facility ridesharing—general policy.

This section sets forth policy and procedures governing promotion by executive agencies of ridesharing at federally owned or operated facilities and provides for the establishment and administration of a nationwide system of Federal facility employee transportation coordinators (ETC's). The authority for this subpart is Executive Order 12191, dated February 1, 1980, which established the Federal Facility Ridesharing Program and delegated the primary responsibility for program development, implementation, and administration to the Administrator of General Services in consultation with the Secretary of Transportation.

(a) Executive agencies shall actively promote the use of ridesharing at all Federal facilities. This promotion shall include cooperation with State and local ridesharing agencies where such agencies exist. In the process of promoting ridesharing, the Government shall not favor or endorse one commercial firm or nonprofit organization to the exclusion of other commercial firms or nonprofit organizations.

(b) Each executive agency shall issue instructions as may be necessary to implement Federal facility ridesharing programs and to obtain annual ridesharing program reports at those facilities where the agency is responsible for providing the ETC. The information provided by each ETC should include methods used to promote ridesharing

Federal Property Management Regulations

§ 101-6.302

at his/her facility and any achievements or significant barriers encountered. Each executive agency shall maintain a current record of the names, titles, addresses, and telephone numbers of its facility ETC's, nationwide.

(c) Agencies are required to submit a Federal Facility Ridesharing Report to GSA by June 1 of each year (see §101-6.303). The report shall contain a summary of the information provided by the facility ETC's and any other pertinent information applicable to the agency's ridesharing program.

(d) Wherever possible, agencies shall use and promote existing ridematching services. Where ridematching services do not exist, they shall be established, preferably in conjunction with nearby facilities. Ridematching systems may be manual i.e., bulletin board or locator board, or computerized. All systems must comply with the provisions of the Privacy Act of 1974.

(e) Wherever possible, agencies shall implement parking incentives which promote ridesharing and the efficient use of federally controlled parking areas. Agencies are also encouraged to work with private parking management concerns in or near Federal facilities to encourage the use of carpools and vanpools.

(f) Whenever feasible, agencies should consider providing for flexibility in employee working hours to facilitate ridesharing arrangements.

(g) For more information on Federal facility ridesharing, see 41 CFR parts 102-71 through 102-82. To the extent that any policy statements in this subpart are inconsistent with the policy statements in 41 CFR parts 102-71 through 102-82, the policy statements in 41 CFR parts 102-71 through 102-82 are controlling.

[49 FR 20289, May 14, 1984, as amended at 53 FR 27518, July 21, 1988; 66 FR 5358, Jan. 18, 2001]

§ 101-6.301 Definitions.

(a) *Ridesharing*. Sharing of the commute to and from work by two or more people, on a continuing basis, regardless of their relationship to each other, in any mode of transportation, including but not limited to: carpools, vanpools, buspools and mass transit.

(b) *Ridematching*. Any manual or automated system that gathers commuter information from interested individuals and processes this information to identify potential ridesharing arrangements among these individuals.

(c) *Facility*. Either a single building or a group of buildings or work locations at a common site.

(d) *Third party operator*. A ridesharing agency or other organization, whether public or private, that leases vans or buses to employers or individual employees.

(e) *Federal facility employee transportation coordinator*. An individual appointed by the agency who provides commuter ridesharing services to all employees at the facility and who serves as a point of contact for local and State ridesharing agencies, where they exist.

(f) *Agencywide employee transportation coordinator*. An individual appointed by the agency, who is responsible for planning, organizing, and directing an agencywide ridesharing program, and serves as a point of contact for the agency's Federal facility ETC's and also as the ridesharing liaison between the agency and GSA.

§ 101-6.302 Employee transportation coordinators.

(a) *Federal facility employee transportation coordinator*. Agencies shall designate an ETC at each Federal facility with 100 or more full-time employees on one shift. Agencies are encouraged to appoint coordinators at facilities with less than 100 full-time employees where such a coordinator can provide significant benefits to the ridesharing program. At a facility occupied by more than one Federal agency, the executive agency having the largest number of employees shall have the lead responsibility for program coordination and implementation for all the Federal agencies at the facility and shall provide the ETC for the facility. Should a smaller agency volunteer to provide the facility ETC, the lead agency may transfer this responsibility to the smaller agency. The Federal facility ETC shall:

(1) Promote ridesharing at the facility by:

§ 101-6.303

(i) Publicizing the name, location, and telephone number of the employee transportation coordinator by using bulletin boards, memoranda, newsletters, etc.;

(ii) Assisting employees in joining or forming carpools or vanpools;

(iii) Aiding employee participation in ridematching programs (Where ridematching programs do not exist, action should be taken to establish them);

(iv) Working closely with the parking management offices to promote ridesharing through preferential parking incentives;

(v) Establishing ridesharing orientation for new and transferring employees at the facility;

(vi) Utilizing ridesharing resources provided by State and local ridesharing agencies and participating in special ridesharing events;

(vii) Publicizing the availability of public transportation;

(viii) Communicating employee transportation needs to local public transportation authorities and other organizations (such as private bus companies) furnishing multipassenger modes of transportation; and

(ix) Establishing ridesharing goals and objectives for the facility.

(2) Prepare a facility report for annual submission to the agencywide coordinator.

(b) *Agencywide employee transportation coordinator.* Agencies shall appoint an individual to serve as an agencywide ETC. The agencywide ETC shall:

(1) Serve as a point of contact for the agency's facility ETC's;

(2) Serve as a liaison between other agencywide ETC's, State, and local ridesharing agencies and the GSA Central Office;

(3) Assist in the development and implementation of an agencywide ridesharing program; and

(4) Submit promptly any change in the name, address, title, or telephone number of the agencywide ETC to GSA.

§ 101-6.303 Reporting procedures.

(a) The head of each agency shall submit to GSA by June 1 of each year a report which shall include:

(1) The name, address, title, and telephone number of the agencywide ETC;

41 CFR Ch. 101 (7-1-01 Edition)

(2) A narrative on actions taken and barriers encountered in promoting ridesharing within the agency;

(3) Information on any notable facility achievements; and

(4) A copy of instructions issued to the agency's facility ETC's for implementing the Federal Facility Ridesharing Program.

(b) Reports shall be submitted to: Federal Facility Ridesharing Program, General Services Administration (PQ) Washington, DC 20405. The telephone number for the program is FTS 566-0059 (202-566-0059).

(c) Interagency report control number 0258-GSA-AN has been assigned to this report.

[49 FR 20289, May 14, 1984, as amended at 53 FR 27518, July 21, 1988]

§ 101-6.304 Exemptions.

Facilities with less than 100 full-time employees or less than 100 full-time employees on the largest shift are not required to submit an annual report. Agencies shall not subdivide buildings, groups of buildings, or worksites for the purpose of meeting the exemption standards.

§ 101-6.305 Assistance to agencies.

(a) Due to the large number of Federal, State, local and private sector groups involved in the promotion of ridesharing programs, there are various resources available to Federal agencies interested in technical assistance and promotional materials for use in their ridesharing programs. To aid agencies in identifying these resources, GSA has designated ridesharing coordinators at each of its regional offices. A list of these coordinators and information concerning the national program can be obtained by contacting the office listed in §101-6.303(b).

(b) Ridesharing management assistance is often available from local ridesharing agencies found in most cities throughout the country. These agencies may be sponsored by State or local governments, public transportation authorities, universities, Chambers of Commerce, Councils of Governments, etc. In addition to providing commuter matching services, these agencies have experience in local ridesharing promotion activities, vanpool and buspool

Federal Property Management Regulations

§ 101-6.600

programs, and are familiar with management of commuter disruptions such as transit strikes, bridge closings, as well as air pollution alerts. ETC's are encouraged to use the services of the local ridesharing agencies to the greatest extent possible.

Subpart 101-6.4—Official Use of Government Passenger Carriers Between Residence and Place of Employment

SOURCE: 65 FR 54966, Sept. 12, 2000, unless otherwise noted.

§ 101-6.400 Cross-reference to the Federal Management Regulation (FMR) (41 CFR chapter 102, parts 102-1 through 102-220).

For policy concerning official use of Government passenger carriers between residence and place of employment previously contained in this part, see FMR part 5 (41 CFR part 102-5), Home-to-Work Transportation.

Subpart 101-6.5—Code of Ethics for Government Service

§ 101-6.500 Scope of subpart.

(a) In accordance with Public Law 96-303, the requirements of this section shall apply to all executive agencies (as defined by section 105 of title 5, United States Code), the United States Postal Service, and the Postal Rate Commission. The heads of these agencies shall be responsible for ensuring that the requirements of this section are observed and complied with within their respective agencies.

(b) Each agency, as defined in "(a)" above, shall display in appropriate areas of buildings in which at least 20 individuals are regularly employed by an agency as civilian employees, copies of the Code of Ethics for Government Service (Code).

(c) For Government-owned or wholly leased buildings subject to the requirements of this section, at least one copy of the Code shall be conspicuously displayed, normally in the lobby of the main entrance to the building. For other buildings subject to the requirements of this section which are owned, leased, or otherwise provided to the

Federal Government for the purpose of performing official business, at least one copy of the Code shall be conspicuously displayed within the space occupied by the Government. In all cases, additional copies of the Code may be displayed in other appropriate building locations, such as auditoriums, bulletin boards, cafeterias, locker rooms, reception areas, and other high-traffic areas.

(d) Agencies of the Federal Government shall not pay any costs for the printing, framing, or other preparation of the Code. Agencies may properly pay incidental expenses, such as the cost of hardware, other materials, and labor incurred to display the Code. Display shall be consistent with the decor and architecture of the building space. Installation shall cause no permanent damage to stonework or other surfaces which are difficult to maintain or repair.

(e) Agencies may obtain copies of the Code by submitting a requisition for National Stock Number (NSN) 7690-01-099-8167 in Fedstrip format to the GSA regional office responsible for providing support to the requisitioning agency. Agencies will be charged a nominal fee to cover shipping and handling.

[58 FR 21945, Apr. 28, 1994]

Subpart 101-6.6—Fire Protection (Firesafety) Engineering

SOURCE: 59 FR 54531, Nov. 1, 1994, unless otherwise noted.

§ 101-6.600 Scope of subpart.

(a) This subpart provides the regulations of the General Services Administration (GSA) under Title I of the Fire Administration Authorization Act of 1992 concerning definition and determination of *equivalent level of safety*. The primary objective of this regulation is to provide a quantifiable means of determining compliance with the requirements of the Act. It is not a substitute for compliance with building and fire code requirements typically used in construction and occupancy of buildings.

(b) For more information on fire protection (firesafety) engineering, see 41

§ 101-6.601

CFR parts 102-71 through 102-82. To the extent that any policy statements in this subpart are inconsistent with the policy statements in 41 CFR parts 102-71 through 102-82, the policy statements in 41 CFR parts 102-71 through 102-82 are controlling.

[59 FR 54531, Nov. 1, 1994, as amended at 66 FR 5358, Jan. 18, 2001]

§ 101-6.601 Background.

(a) The Fire Administration Authorization Act of 1992 (Pub. Law 102-522) was signed into law by the President on October 26, 1992. Section 106 Fire Safety Systems in Federally Assisted Buildings, of Title I—United States Fire Administration, is commonly referred to as the Federal Fire Safety Act of 1992. This section amends the Fire Prevention and Control Act of 1974 (15 U.S.C. 2201 *et seq.*) to require sprinklers or an *equivalent of safety*, in certain types of Federal employee office buildings, Federal employee housing units, and federally assisted housing units.

(b) The definition of an automatic sprinkler system is unique to the Act. In addition to describing the physical characteristics of an automatic sprinkler system, the definition sets a performance objective for the system. Automatic sprinkler systems installed in compliance with the Act must *protect human lives*. Sprinklers would provide the level of life safety prescribed in the Act by controlling the spread of fire and its effects beyond the room of origin. A functioning sprinkler system should activate prior to the onset of flashover.

(c) This subpart establishes a general measure of building firesafety performance. To achieve the level of life safety specified in the Act, the structure under consideration must be designed, constructed, and maintained to minimize the impact of fire. As one option, building environmental conditions are specified in this subpart to ensure the life safety of building occupants outside the room of fire origin. They should be applicable independent of whether or not the evaluation is being conducted for the entire building or for just the hazardous areas. In the latter case, the room of origin would be the hazardous area while any room, space,

41 CFR Ch. 101 (7-1-01 Edition)

or area could be a room of origin in the entire building scenario.

(d) The *equivalent level of safety* regulation in this subpart does not address property protection, business interruption potential, or firefighter safety during fire fighting operations. In situations where firefighters would be expected to rescue building occupants, the safety of both firefighters and occupants must be considered in the *equivalent level of safety* analysis. Thorough prefire planning will allow firefighters to choose whether or not to enter a burning building solely to fight a fire.

§ 101-6.602 Application.

The requirements of the Act and this subpart apply to all Federal agencies and all federally owned and leased buildings in the United States, except those under the control of the Resolution Trust Corporation.

§ 101-6.603 Definitions.

(a) *Qualified fire protection engineer* is defined as an individual, with a thorough knowledge and understanding of the principles of physics and chemistry governing fire growth, spread, and suppression, meeting one of the following criteria:

(1) An engineer having an undergraduate or graduate degree from a college or university offering a course of study in fire protection or firesafety engineering, plus a minimum of four (4) years work experience in fire protection engineering,

(2) A professional engineer (P.E. or similar designation) registered in Fire Protection Engineering, or

(3) A professional engineer (P.E. or similar designation) registered in a related engineering discipline and holding Member grade status in the International Society of Fire Protection Engineers.

(b) *Flashover* means fire conditions in a confined area where the upper gas layer temperature reaches 600 °C (1100 °F) and the heat flux at floor level exceeds 20 kW/m² (1.8 Btu/ft²/sec).

(c) *Reasonable worst case fire scenario* means a combination of an ignition source, fuel items, and a building location likely to produce a fire which

would have a significant adverse impact on the building and its occupants. The development of *reasonable worst case scenarios* must include consideration of types and forms of fuels present (e.g., furniture, trash, paper, chemicals), potential fire ignition locations (e.g., bedroom, office, closet, corridor), occupant capabilities (e.g., awake, intoxicated, mentally or physically impaired), numbers of occupants, detection and suppression system adequacy and reliability, and fire department capabilities. A quantitative analysis of the probability of occurrence of each scenario and combination of events will be necessary.

(d) *Room of origin* means an area of a building where a fire can be expected to start. Typically, the size of the area will be determined by the walls, floor, and ceiling surrounding the space. However, this could lead to unacceptably large areas in the case of open plan office space or similar arrangements. Therefore, the maximum allowable fire area should be limited to 200 m² (2000 ft²) including intervening spaces. In the case of residential units, an entire apartment occupied by one tenant could be considered as the *room of origin* to the extent it did not exceed the 200 m² (2000 ft²) limitation.

§ 101-6.604 Requirements.

(a) The equivalent level of life safety evaluation is to be performed by a qualified fire protection engineer. The analysis should include a narrative discussion of the features of the building structure, function, operational support systems and occupant activities which impact fire protection and life safety. Each analysis should describe potential reasonable worst case fire scenarios and their impact on the building occupants and structure. Specific issues which must be addressed include rate of fire growth, type and location of fuel items, space layout, building construction, openings and ventilation, suppression capability, detection time, occupant notification, occupant reaction time, occupant mobility, and means of egress.

(b) To be acceptable, the analysis must indicate that the existing and/or proposed safety systems in the building provide a period of time equal to or

greater than the amount of time available for escape in a similar building complying with the Act. In conducting these analyses, the capability, adequacy, and reliability of all building systems impacting fire growth, occupant knowledge of the fire, and time required to reach a safety area will have to be examined. In particular, the impact of sprinklers on the development of hazardous conditions in the area of interest will have to be assessed. Three options are provided for establishing that an *equivalent level of safety* exists.

(1) In the first option, the margin of safety provided by various alternatives is compared to that obtained for a code complying building with complete sprinkler protection. The margin of safety is the difference between the available safe egress time and the required safe egress time. Available safe egress time is the time available for evacuation of occupants to an area of safety prior to the onset of untenable conditions in occupied areas or the egress pathways. The required safe egress time is the time required by occupants to move from their positions at the start of the fire to areas of safety. Available safe egress times would be developed based on analysis of a number of assumed *reasonable worst case fire scenarios* including assessment of a code complying fully sprinklered building. Additional analysis would be used to determine the expected required safe egress times for the various scenarios. If the margin of safety plus an appropriate safety factor is greater for an alternative than for the fully sprinklered building, then the alternative should provide an *equivalent level of safety*.

(2) A second alternative is applicable for typical office and residential scenarios. In these situations, complete sprinkler protection can be expected to prevent flashover in the room of fire origin, limit fire size to no more than 1 megawatt (950 Btu/sec), and prevent flames from leaving the room of origin. The times required for each of these conditions to occur in the area of interest must be determined. The shortest of these three times would become the time available for escape. The difference between the minimum time

§ 101-6.605

available for escape and the time required for evacuation of building occupants would be the target margin of safety. Various alternative protection strategies would have to be evaluated to determine their impact on the times at which hazardous conditions developed in the spaces of interest and the times required for egress. If a combination of fire protection systems provides a margin of safety equal to or greater than the target margin of safety, then the combination could be judged to provide an *equivalent level of safety*.

(3) As a third option, other technical analysis procedures, as approved by the responsible agency head, can be used to show equivalency.

(c) Analytical and empirical tools, including fire models and grading schedules such as the Fire Safety Evaluation System (Alternative Approaches to Life Safety, NEPA 101M) should be used to support the life safety equivalency evaluation. If fire modeling is used as part of an analysis, an assessment of the predictive capabilities of the fire models must be included. This assessment should be conducted in accordance with the American Society for Testing and Materials Standard Guide for Evaluating the Predictive Capability of Fire Models (ASTM E 1355).

§ 101-6.605 Responsibility.

The head of the agency responsible for physical improvements in the facility or providing Federal assistance or a designated representative will determine the acceptability of each *equivalent level of safety* analysis. The determination of acceptability must include a review of the fire protection engineer's qualifications, the appropriateness of the fire scenarios for the facility, and the reasonableness of the assumed maximum probable loss. Agencies should maintain a record of each accepted *equivalent level of safety* analysis and provide copies to fire departments or other local authorities for use in developing prefire plans.

Subparts 101-6.7—101-6.9 [Reserved]

41 CFR Ch. 101 (7-1-01 Edition)

Subpart 101-6.10—Federal Advisory Committee Management

AUTHORITY: Sec. 205(c), 63 Stat. 390; 40 U.S.C. 486(c); sec. 7, 5 U.S.C. app.; and E.O. 12024, 3 CFR 1977 Comp., p. 158.

SOURCE: 52 FR 45929, Dec. 2, 1987, unless otherwise noted.

§ 101-6.1001 Scope.

(a) This subpart defines the policies, establishes minimum requirements, and provides guidance to agency management for the establishment, operation, administration, and duration of advisory committees subject to the Federal Advisory Committee Act, as amended. Reporting requirements which keep the Congress and the public informed of the number, purpose, membership activities, and cost of these advisory committees are also included.

(b) The Act and this subpart do not apply to advisory meetings or groups listed in § 101-6.1004.

[52 FR 45929, Dec. 2, 1987, as amended at 54 FR 41215, Oct. 5, 1989]

§ 101-6.1002 Policy.

The policy to be followed by Federal departments, agencies, and commissions, consistent with the Federal Advisory Committee Act, as amended, is as follows:

(a) An advisory committee shall be established only when it is essential to the conduct of agency business. Decision criteria include whether committee deliberations will result in the creation or elimination of, or change in regulations, guidelines, or rules affecting agency business; whether the information to be obtained is already available through another advisory committee or source within the Federal Government; whether the committee will make recommendations resulting in significant improvements in service or reductions in cost; or whether the committee's recommendations will provide an important additional perspective or viewpoint impacting agency operations;

(b) An advisory committee shall be terminated whenever the stated objectives of the committee have been accomplished; the subject matter or work of the committee has become obsolete

Federal Property Management Regulations

§ 101-6.1004

by the passing of time or the assumption of the committee's main functions by another entity within the Federal Government; or the agency determines that the cost of operation is excessive in relation to the benefits accruing to the Federal Government;

(c) An advisory committee shall be fairly balanced in its membership in terms of the points of view represented and the functions to be performed; and

(d) An advisory committee shall be open to the public in its meetings except in those circumstances where a closed meeting shall be determined proper and consistent with the provisions in the Government in the Sunshine Act, 5 U.S.C. 552(b).

[52 FR 45929, Dec. 2, 1987, as amended at 54 FR 41215, Oct. 5, 1989]

§ 101-6.1003 Definitions.

Act means the Federal Advisory Committee Act, as amended, 5 U.S.C., App.

Administrator means the Administrator of General Services.

Advisory committee subject to the Act means any committee, board, commission, council, conference, panel, task force, or other similar group, or any subcommittee or other subgroup thereof, which is established by statute, or established or utilized by the President or any agency official for the purpose of obtaining advice or recommendations on issues or policies which are within the scope of his or her responsibilities.

Agency has the same meaning as in section 551(1) of title 5 of the United States Code.

Committee Management Secretariat (Secretariat), established pursuant to the Act is responsible for all matters relating to advisory committees, and carries out the Administrator's responsibilities under the Act and Executive Order 12024.

Committee member means an individual who serves by appointment on an advisory committee and has the full right and obligation to participate in the activities of the committee, including voting on committee recommendations.

Presidential advisory committee means any advisory committee which advises the President. It may be established by the President or by the Congress, or

used by the President in the interest of obtaining advice or recommendations for the President. "Independent Presidential advisory committee" means any Presidential advisory committee not assigned by the President, or the President's delegate, or by the Congress in law, to an agency for administrative and other support and for which the Administrator of General Services may provide administrative and other support on a reimbursable basis.

Staff member means any individual who serves in a support capacity to an advisory committee.

Utilized (or used), as referenced in the definition of *Advisory committee* in this section, means a committee or other group composed in whole or in part of other than full-time officers or employees of the Federal Government with an established existence outside the agency seeking its advice which the President or agency official(s) adopts, such as through institutional arrangements, as a preferred source from which to obtain advice or recommendations on a specific issue or policy within the scope of his or her responsibilities in the same manner as that individual would obtain advice or recommendations from an established advisory committee.

§ 101-6.1004 Examples of advisory meetings or groups not covered by the Act or this subpart.

The following are examples of advisory meetings or groups not covered by the Act or this subpart;

(a) Any committee composed wholly of full-time officers or employees of the Federal Government;

(b) Any advisory committee specifically exempted by an Act of Congress;

(c) Any advisory committee established or utilized by the Central Intelligence Agency;

(d) Any advisory committee established or utilized by the Federal Reserve System;

(e) The Advisory Committee on Intergovernmental Relations;

(f) Any local civic group whose primary function is that of rendering a public service with respect to a Federal program, or any State or local committee, council, board, commission, or similar group established to advise or

§ 101-6.1005

41 CFR Ch. 101 (7-1-01 Edition)

make recommendations to State or local officials or agencies;

(g) Any committee which is established to perform primarily operational as opposed to advisory functions. Operational functions are those specifically provided by law, such as making or implementing Government decisions or policy. An operational committee may be covered by the Act if it becomes primarily advisory in nature. It is the responsibility of the administering agency to determine whether such a committee is primarily operational. If so, it would not fall under the requirements of the Act and this subpart, but would continue to be regulated under relevant laws, subject to the direction of the President and the review of the appropriate legislative committees;

(h) Any meeting initiated by the President or one or more Federal official(s) for the purpose of obtaining advice or recommendations from one individual;

(i) Any meeting initiated by a Federal official(s) with more than one individual for the purpose of obtaining the advice of individual attendees and not for the purpose of utilizing the group to obtain consensus advice or recommendations. However, agencies should be aware that such a group would be covered by the Act when an agency accepts the group's deliberations as a source of consensus advice or recommendations;

(j) Any meeting initiated by a group with the President or one or more Federal official(s) for the purpose of expressing the group's view, provided that the President or Federal official(s) does not use the group recurrently as a preferred source of advice or recommendations;

(k) Meetings of two or more advisory committee or subcommittee members convened solely to gather information or conduct research for a chartered advisory committee, to analyze relevant issues and facts, or to draft proposed position papers for deliberation by the advisory committee or a subcommittee of the advisory committee; or

(l) Any meeting with a group initiated by the President or one or more Federal official(s) for the purpose of exchanging facts or information.

§ 101-6.1005 Authorities for establishment of advisory committees.

An advisory committee may be established in one of four ways:

(a) By law where the Congress specifically directs the President or an agency to establish it;

(b) By law where the Congress authorizes but does not direct the President or an agency to establish it. In this instance, the responsible agency head shall follow the procedures provided in § 101-6.1007;

(c) By the President by Executive Order; or

(d) By an agency under general agency authority in title 5 of the United States Code or under other general agency-authorizing law. In this instance, an agency head shall follow the procedures provided in § 101-6.1007.

§ 101-6.1006 [Reserved]

§ 101-6.1007 Agency procedures for establishing advisory committees.

(a) When an agency head decides that it is necessary to establish a committee, the agency must consider the functions of similar committees in the same agency before submitting a consultation to GSA to ensure that no duplication of effort will occur.

(b) In establishing or utilizing an advisory committee, the head of an agency or designee shall comply with the Act and this subpart, and shall:

(1) Prepare a proposed charter for the committee which includes the information listed in section 9(c) of the Act; and

(2) Submit a letter and the proposed charter to the Secretariat proposing to establish or use, reestablish, or renew an advisory committee. The letter shall include the following information:

(i) An explanation of why the committee is essential to the conduct of agency business and in the public interest;

(ii) An explanation of why the committee's functions cannot be performed by the agency, another existing advisory committee of the agency, or other means such as a public hearing; and

(iii) A description of the agency's plan to attain fairly balanced membership. The plan will ensure that, in the

Federal Property Management Regulations

§ 101-6.1009

selection of members for the committee, the agency will consider a cross-section of those directly affected, interested, and qualified, as appropriate to the nature and functions of the committee. Committees requiring technical expertise should include persons with demonstrated professional or personal qualifications and experience relevant to the functions and tasks to be performed.

(3) Subcommittees that do not function independently of the full or parent advisory committee need not follow the requirements of paragraphs (b)(1) and (b)(2) of this section. However, they are subject to all other requirements of the Act.

(4) The requirements of paragraphs (b)(1) and (b)(2) of this section shall apply for any subcommittee of a chartered advisory committee, whether its members are drawn in whole or in part from the full or parent advisory committee, which functions independently of the parent advisory committee such as by making recommendations directly to the agency rather than for consideration by the chartered advisory committee.

(c) The Secretariat will review the proposal and notify the agency of GSA's views within 15 calendar days of receipt, if possible. The agency head retains final authority for establishing a particular advisory committee.

(d) The agency shall notify the Secretariat in writing that either:

(1) The advisory committee is being established. The filing of the advisory committee charter as specified in §101-6.1013 shall be considered appropriate written notification in this instance. The date of filing constitutes the date of establishment or renewal. The agency head shall then comply with the provisions of §101-6.1009 for an established advisory committee; or

(2) The advisory committee is not being established. In this instance, the agency shall also advise the Secretariat if the agency head intends to take any further action with respect to the proposed advisory committee.

[52 FR 45929, Dec. 2, 1987, as amended at 54 FR 41215, Oct. 5, 1989]

§ 101-6.1008 The role of GSA.

(a) The functions under section 7 of the Act will be performed for the Administrator by the Secretariat. The Secretariat assists the Administrator in prescribing administrative guidelines and management controls for advisory committees, and assists other agencies in implementing and interpreting these guidelines. In exercising internal controls over the management and supervision of the operations and procedures vested in each agency by section 8(b) of the Act and by §101-6.1009 and §101-6.1017 of this rule, agencies shall conform to the guidelines prescribed by GSA.

(b) The Secretariat may request comments from agencies on management guidelines and policy issues of broad interagency interest or application to the Federal advisory committee program.

(c) In advance of issuing informal guidelines, nonstatutory reporting requirements, and administrative procedures such as report formats or automation, the Secretariat shall request formal or informal comments from agency Committee Management Officers.

(d) The Secretariat shall assure that follow-up reports required by section 6(b) of the Act are prepared and transmitted to the Congress as directed by the President; either by his delegate, by the agency responsible for providing support to a Presidential advisory committee, or by the responsible agency or organization designated pursuant to paragraph (c) of §101-6.1011. In performing this function, GSA may solicit the assistance of the Office of Management and Budget and other appropriate organizations, as deemed appropriate.

[52 FR 45929, Dec. 2, 1987, as amended at 54 FR 41215, Oct. 5, 1989]

§ 101-6.1009 Responsibilities of an agency head.

The head of each agency that uses one or more advisory committees shall ensure:

(a) Compliance with the Act and this subpart;

(b) Issuance of administrative guidelines and management controls which

§ 101-6.1010

apply to all advisory committees established or used by the agency;

(c) Designation of a Committee Management Officer who shall carry out the functions specified in section 8(b) of the Act;

(d) Provision of a written determination stating the reasons for closing any advisory committee meeting to the public;

(e) A review, at least annually, of the need to continue each existing advisory committee, consistent with the public interest and the purpose and functions of each committee;

(f) Rates of pay are justified and levels of agency support are adequate;

(g) The appointment of a Designated Federal Officer for each advisory committee and its subcommittees;

(h) The opportunity for reasonable public participation in advisory committee activities;

(i) That the number of committee members is limited to the fewest necessary to accomplish committee objectives;

(j) That the interests and affiliations of advisory committee members are reviewed consistent with regulations published by the Office of Government Ethics in 5 CFR parts 734, 735, and 737, and additional requirements, if any, established by the sponsoring agency pursuant to Executive Order 12674, the conflict-of-interest statutes, and the Ethics in Government Act of 1978, as amended; and

(k) Unless otherwise specified by the President, the preparation and transmittal of a follow-up report to the Congress detailing the disposition of the public recommendations of a Presidential advisory committee supported by the agency, in accordance with sections 6(b) of the Act.

[52 FR 45929, Dec. 2, 1987, as amended at 54 FR 41215, Oct. 5, 1989]

§ 101-6.1010 [Reserved]

§ 101-6.1011 Responsibilities of the chairperson of an independent Presidential advisory committee.

The chairperson of an independent Presidential advisory committee shall comply with the Act and this subpart and shall:

41 CFR Ch. 101 (7-1-01 Edition)

(a) Consult with the Administrator concerning the role of the Designated Federal Officer and Committee Management Officer;

(b) Fulfill the responsibilities of an agency head as specified in paragraphs (d), (h) and (j) of § 101-6.1009; and

(c) Unless otherwise specified by the President, consult with the Administrator regarding the designation of an agency or organization responsible for implementing section 6(b) of the Act.

[52 FR 45929, Dec. 2, 1987, as amended at 54 FR 41216, Oct. 5, 1989]

§ 101-6.1012 [Reserved]

§ 101-6.1013 Charter filing requirements.

No advisory committee may operate, meet, or take any action until its charter has been filed as follows:

(a) *Advisory committee established, used, reestablished, or renewed by an agency.* The agency head shall file—

(1) The charter with the standing committees of the Senate and the House of Representatives having legislative jurisdiction of the agency;

(2) A copy of the filed charter with the Library of Congress, Exchange and Gift Division, Federal Documents Section, Federal Advisory Committee Desk, Washington, DC 20540; and

(3) A copy of the charter indicating the Congressional filing date, with the Secretariat.

(b) *Advisory committee specifically directed by law or authorized by law.* Procedures are the same as in paragraph (a) of this section.

(c) *Presidential advisory committee.* When either the President or the Congress establishes an advisory committee that advises the President, the responsible agency head or, in the case of an independent Presidential advisory committee, the President's designee shall file—

(1) The charter with the Secretariat;

(2) A copy of the filed charter with the Library of Congress; and

(3) If specifically directed by law, a copy of the charter indicating its date of filing with the Secretariat, with the standing committees on the Senate and the House of Representatives having legislative jurisdiction of the agency or

Federal Property Management Regulations

§ 101-6.1019

the independent Presidential advisory committee.

§ 101-6.1014 [Reserved]

§ 101-6.1015 Advisory committee information which must be published in the Federal Register.

(a) *Committee establishment, reestablishment, or renewal.* (1) A notice in the FEDERAL REGISTER is required when an advisory committee, except a committee specifically directed by law or established by the President by Executive Order, is established, used, reestablished, or renewed. Upon receiving notification of the completed review from the Secretariat in accordance with paragraph (c) of §101-6.1007, the agency shall publish a notice in the FEDERAL REGISTER that the committee is being established, used, reestablished, or renewed. For a new committee, such notice shall also describe the nature and purpose of the committee and the agency's plan to attain fairly balanced membership, and shall include a statement that the committee is necessary and in the public interest.

(2) Establishment and reestablishment notices shall appear at least 15 calendar days before the committee charter is filed, except that the Secretariat may approve less than 15 days when requested by the agency for good cause. The 15-day advance notice requirement does not apply to committee renewals, notices of which may be published concurrently with the filing of the charter.

(b) *Committee meetings.* (1) The agency or an independent Presidential advisory committee shall publish at least 15 calendar days prior to an advisory committee meeting a notice in the FEDERAL REGISTER, which includes:

(i) The exact name of the advisory committee as chartered;

(ii) The time, date, place, and purpose of the meeting;

(iii) A summary of the agenda; and

(iv) A statement whether all or part of the meeting is open to the public or closed, and if closed, the reasons why, citing the specific exemptions of the Government in the Sunshine Act (5 U.S.C. 552(b)) as the basis for closure.

(2) In exceptional circumstances, the agency or an independent Presidential

advisory committee may give less than 15 days notice, provided that the reasons for doing so are included in the committee meeting notice published in the FEDERAL REGISTER.

[52 FR 45929, Dec. 2, 1987, as amended at 54 FR 41216, Oct. 5, 1989]

§ 101-6.1016 [Reserved]

§ 101-6.1017 Responsibilities of the agency Committee Management Officer.

In addition to implementing the provisions of section 8(b) of the Act, the Committee Management Officer will carry out all responsibilities delegated by the agency head. The Committee Management Officer should also ensure that section 10(b), 12(a) and 13 of the Act are implemented by the agency to provide for appropriate recordkeeping. Records include, but are not limited to:

(a) A set of approved charters and membership lists for each advisory committee;

(b) Copies of the agency's portion of the Annual Report of Federal Advisory Committees required by paragraph (b) of § 101-6.1035;

(c) Agency guidelines on committee management operations and procedures as maintained and updated; and

(d) Agency determinations to close advisory committee meetings as required by paragraph (c) of § 101-6.1023.

§ 101-6.1018 [Reserved]

§ 101-6.1019 Duties of the Designated Federal Officer.

The agency head or, in the case of an independent Presidential advisory committee, the Administrator shall designate a Federal officer or employee, who may be either full-time or permanent part-time, to be the Designated Federal Officer for each advisory committee and its subcommittees, who:

(a) Must approve or call the meeting of the advisory committee;

(b) Must approve the agenda;

(c) Must attend the meetings;

(d) Shall adjourn the meetings when such adjournment is in the public interest; and

(e) Chairs the meeting when so directed by the agency head.

§ 101-6.1020

(f) The requirement in paragraph (b) of this section does not apply to a Presidential advisory committee.

§ 101-6.1020 [Reserved]

§ 101-6.1021 Public participation in advisory committee meetings.

The agency head, or the chairperson of an independent Presidential advisory committee, shall ensure that—

(a) Each advisory committee meeting is held at a reasonable time and in a place reasonably accessible to the public;

(b) The meeting room size is sufficient to accommodate advisory committee members, committee or agency staff, and interested members of the public;

(c) Any member of the public is permitted to file a written statement with the advisory committee; and

(d) Any member of the public may speak at the advisory committee meeting if the agency's guidelines so permit.

§ 101-6.1022 [Reserved]

§ 101-6.1023 Procedures for closing an advisory committee meeting.

(a) To close all or part of a meeting, an advisory committee shall submit a request to the agency head or, in the case of an independent Presidential advisory committee, the Administrator, citing the specific provisions of the Government in the Sunshine Act (5 U.S.C. 552(b)) which justify the closure. The request shall provide the agency head or the Administrator sufficient time to review the matter in order to make a determination prior to publication of the meeting notice required by § 101-6.1015(b).

(b) The general counsel of the agency or, in the case of an independent Presidential advisory committee, the general counsel of the General Services Administration should review all requests to close meetings.

(c) If the agency head or, in the case of an independent Presidential advisory committee, the Administrator agrees that the request is consistent with the provisions in the Government in the Sunshine Act and the Federal Advisory Committee Act, he or she

41 CFR Ch. 101 (7-1-01 Edition)

shall issue a determination that all or part of the meeting be closed.

(d) The agency head, or the chairperson of an independent Presidential advisory committee, shall:

(1) Make a copy of the determination available to the public upon request; and

(2) State the reasons why all or part of the meeting is closed, citing the specific exemptions used from the Government in the Sunshine Act in the meeting notice published in the FEDERAL REGISTER.

§ 101-6.1024 [Reserved]

§ 101-6.1025 Requirement for maintaining minutes of advisory committee meetings.

(a) The agency head or, in the case of an independent Presidential advisory committee, the chairperson shall ensure that detailed minutes of each advisory committee meeting are kept. The minutes must include:

(1) Time, date, and place;

(2) A list of the following persons who were present:

(i) Advisory committee members and staff;

(ii) Agency employees; and

(iii) Members of the public who presented oral or written statements;

(3) An estimated number of other members of the public present;

(4) An accurate description of each matter discussed and the resolution, if any, made by the committee of such matter; and

(5) Copies of each report or other document received, issued, or approved by the committee.

(b) The chairperson of each advisory committee shall certify to the accuracy of all minutes of advisory committee meetings.

§ 101-6.1026 [Reserved]

§ 101-6.1027 Termination of advisory committees.

(a) Any advisory committee shall automatically terminate not later than 2 years after it is established, reestablished, or renewed, unless:

(1) Its duration is otherwise provided for by law;

Federal Property Management Regulations

§ 101-6.1031

(2) The President or agency head renews it prior to the end of such period; or

(3) The President or agency head terminates it before that time by revoking or abolishing its establishment authority.

(b) If an agency head terminates an advisory committee, the agency shall notify the Secretariat of the effective date of termination.

§ 101-6.1028 [Reserved]

§ 101-6.1029 Renewal and rechartering of advisory committees.

(a) Advisory committees specifically directed by law:

(1) Whose duration extends beyond 2 years shall require rechartering by the filing of a new charter every 2 years after the date of enactment of the law establishing the committee. If a new charter is not filed, the committee is not terminated, but may not meet or take any action.

(2) Which would terminate under the provisions of section 14 of the Act, and for which renewal would require reauthorization by law, may be reestablished by an agency provided that the agency complies under general agency authority with the provisions of §101-6.1007.

(b) Advisory committees established by the President may be renewed by appropriate action of the President and the filing of a new charter.

(c) Advisory committees authorized by law or established or used by an agency may be renewed, provided that at least 30 but not more than 60 days before the committee terminates, an agency head who intends to renew a committee complies with the provisions of §101-6.1007.

§ 101-6.1030 [Reserved]

§ 101-6.1031 Amendments to advisory committee charters.

(a) *Committees specifically directed by law or authorized by law; or established by the President.* The agency head shall be responsible for ensuring that any minor technical changes made to current charters are consistent with the relevant statute or Executive Order.

When the Congress by law, or the President by Executive Order, changes the authorizing language which has been the basis for establishing an advisory committee, the agency head, or the chairperson of an independent Presidential advisory committee, shall:

(1) Amend those sections of the current charter affected by the new law or Executive Order; and

(2) File the amended charter as specified in §101-6.1013.

(b) *Committees established or used by an agency.* The charter of an advisory committee established under general agency authority may be amended when an agency head determines that the existing charter no longer accurately reflects the objectives or functions of the committee. Changes may be minor, such as revising the name of the advisory committee, or modifying the estimated number or frequency of meetings. Changes may also be major such as those dealing with the objectives or composition of the committee. The agency head retains final authority for amending the charter of an advisory committee. Amending any existing advisory committee charter does not constitute renewal of the committee under §101-6.1029.

(1) To make a minor amendment to a committee charter, an agency shall:

(i) Amend the charter language as necessary, and

(ii) File the amended charter as specified in §101-6.1013.

(2) To make a major amendment to a committee charter, an agency shall:

(i) Amend the charter language as necessary;

(ii) Submit the proposed amended charter with a letter to the Secretariat requesting GSA's views on the amended language, along with an explanation of the purpose of the changes and why they are necessary. The Secretariat will review the proposed changes and notify the agency of GSA's views within 15 calendar days of the request, if possible; and

(iii) File the amended charter as specified in §101-6.1013.

§ 101-6.1032

41 CFR Ch. 101 (7-1-01 Edition)

§ 101-6.1032 [Reserved]

§ 101-6.1033 Compensation and expense reimbursement of advisory committee members, staffs and consultants.

(a) *Uniform pay guidelines for members of an advisory committee.* Nothing in this subpart shall require an agency head to provide compensation, unless otherwise provided by law, to a member of an advisory committee. However, when compensation is deemed appropriate by an agency, it shall fix the pay of the members of an advisory committee to the daily equivalent of a rate of the General Schedule in 5 U.S.C. 5332 unless the members are appointed as consultants and compensated under 5 U.S.C. 3109. In determining an appropriate rate of pay for the members, an agency shall give consideration to the significance, scope, and technical complexity of the matters with which the advisory committee is concerned and the qualifications required of the members of the advisory committee. An agency may not fix the pay of the members of an advisory committee at a rate higher than the daily equivalent of the maximum rate for a GS-15 under the General Schedule, unless a higher rate is mandated by statute, or the head of the agency has personally determined that a higher rate of pay under the General Schedule is justified and necessary. Such a determination must be reviewed by the head of the agency annually. Under this subpart, an agency may not fix the pay of the members of an advisory committee at a rate of pay higher than the daily equivalent of a rate for a GS-18, as provided in 5 U.S.C. 5332.

(b) *Pay for staff members of an advisory committee.* An agency may fix the pay of each advisory committee staff member at a rate of the General Schedule in which the Staff member's position would appropriately be placed (5 U.S.C. chapter 51). An agency may not fix the pay of a staff member at a rate higher than the daily equivalent of the maximum rate for GS-15, unless the agency head has determined that under the General Schedule the staff member's position would appropriately be placed at a grade higher than GS-15. This de-

termination must be reviewed annually by the agency head.

(1) In establishing rates of compensation, the agency head shall comply with any applicable statutes, regulations, Executive Orders, and administrative guidelines.

(2) A staff member who is a Federal employee shall serve with the knowledge of the Designated Federal Officer and the approval of the employee's direct supervisor. If a non-Federal employee, the staff member shall be appointed in accordance with applicable agency procedures, following consultation with the advisory committee.

(c) *Pay for consultants to an advisory committee.* An agency shall fix the pay of a consultant to an advisory committee after giving consideration to the qualifications required of the consultant and the significance, scope, and technical complexity of the work. The compensation may not exceed the maximum rate of pay authorized by 5 U.S.C. 3109, and shall be in accordance with any applicable statutes, regulations, Executive Orders and administrative guidelines.

(d) *Gratuitous services.* In the absence of any special limitations applicable to a specific agency, nothing in this subpart shall prevent an agency from accepting the gratuitous services of an advisory committee member, staff member, or consultant who agrees in advance to serve without compensation.

(e) *Travel expenses.* Advisory committee members and staff members, while engaged in the performance of their duties away from their homes or regular places of business, may be allowed travel expenses, including per diem in lieu of subsistence, as authorized by section 5703 of title 5, United States Code, for persons employed intermittently in the Government service.

(f) *Services for handicapped members.* While performing advisory committee duties, an advisory committee member who is blind or deaf or who qualifies as a handicapped individual may be provided services by a personal assistant for handicapped employees if the member:

(1) Qualifies as a handicapped individual as defined by section 501 of the

Federal Property Management Regulations

§ 101-6.2100

Rehabilitation Act of 1973 (29 U.S.C. 794); and

(2) Does not otherwise qualify for assistance under 5 U.S.C. 3102 by reason of being an employee of an agency.

(g) *Exclusions.* (1) Nothing in this section shall prevent any person who (without regard to his or her service with an advisory committee) is a full-time Federal employee from receiving compensation at a rate which he or she otherwise would be compensated as a full-time Federal employee.

(2) Nothing in this section shall prevent any person who immediately before his or her service with an advisory committee was a full-time Federal employee from receiving compensation at the rate at which he or she was compensated as a full-time Federal employee.

(3) Nothing in this section shall affect a rate of pay or a limitation on a rate of pay that is specifically established by law or a rate of pay established under the General Schedule classification and pay system in chapter 51 and chapter 53 of title 5, United States Code.

§ 101-6.1034 [Reserved]

§ 101-6.1035 Reports required for advisory committees.

(a) Within one year after a Presidential advisory committee has submitted a public report to the President, a follow-up report will be prepared and transmitted to the Congress as determined under paragraph (d) of § 101-6.1008, detailing the disposition of the committee's recommendations in accordance with section 6(b) of the Act. Reports shall be consistent with specific instructions issued periodically by the Secretariat;

(b) The President's annual report to the Congress shall be prepared by GSA based on reports filed on a fiscal year basis by each agency consistent with the information specified in section 6(c) of the Act. Reports from agencies shall be consistent with instructions provided annually by the Secretariat. Agency reports shall also include information requested to enable the Secretariat to carry out the annual comprehensive review of each advisory

committee as required by section 7(b) of the Act. These reports have been cleared in accordance with FIRMR subpart 201-45.6 in 41 CFR chapter 201 and assigned interagency report control number 0304-GSA-XX.

(c) In accordance with section 10(d) of the Act, advisory committees holding closed meetings shall issue reports at least annually, setting forth a summary of activities consistent with the policy of section 552(b) of title 5, United States Code.

(d) Subject to section 552 of title 5, United States Code, eight copies of each report made by an advisory committee, including any report on closed meetings as specified in paragraph (c) of this section, and, where appropriate, background papers prepared by consultants, shall be filed with the Library of Congress as required by section 13 of the Act, for public inspection and use at the location specified in paragraph (a)(2) of § 101-6.1013.

[52 FR 45929, Dec. 2, 1987, as amended at 54 FR 41216, Oct. 5, 1989]

Subparts 101-6.11—101-6.20 [Reserved]

Subpart 101-6.21—Intergovernmental Review of General Services Administration Programs and Activities

AUTHORITY: E.O. 12372, July 14, 1982 (47 FR 30959), as amended Apr. 8, 1983 (48 FR 15887); sec. 401 of the Intergovernmental Cooperation Act of 1968 as amended (31 U.S.C. 6506).

SOURCE: 48 FR 29329, June 24, 1983, unless otherwise noted.

EDITORIAL NOTE: For additional information, see related documents published at 47 FR 57369, Dec. 23, 1982, 48 FR 17101, Apr. 21, 1983, and 48 FR 29096, June 24, 1983.

§ 101-6.2100 Scope of subpart.

This subpart implements Executive Order 12372, "Intergovernmental Review of Federal Programs", for Federal financial assistance and direct Federal development programs of the General Services Administration (GSA).

§ 101-6.2101 What is the purpose of these regulations?

(a) The regulations in this part implement Executive Order 12372, "Intergovernmental Review of Federal Programs," issued July 14, 1982, and amended on April 8, 1983. These regulations also implement applicable provisions of section 401 of the Intergovernmental Cooperation Act of 1968.

(b) These regulations are intended to foster an intergovernmental partnership and a strengthened Federalism by relying on State processes and on State, areawide, regional and local coordination for review of proposed Federal financial assistance and direct Federal development.

(c) These regulations are intended to aid the internal management of GSA, and are not intended to create any right or benefit enforceable at law by a party against GSA or its officers.

§ 101-6.2102 What definitions apply to these regulations?

GSA means the U.S. General Services Administration.

Order means Executive Order 12372, issued July 14, 1982, and amended April 8, 1983, and titled "Intergovernmental Review of Federal Programs."

Administrator means the Administrator of General Services or an official or employee of GSA acting for the Administrator under a delegation of authority.

State means any of the 50 States, the District of Columbia, the Commonwealth of Puerto Rico, the Commonwealth of the Northern Mariana Islands, Guam, American Samoa, the U.S. Virgin Islands, or the Trust Territory of the Pacific Islands.

§ 101-6.2103 What programs and activities of GSA are subject to these regulations?

The Administrator publishes in the FEDERAL REGISTER a list of GSA's programs and activities that are subject to these regulations.

§ 101-6.2104 What are the Administrator's general responsibilities under the Order?

(a) The Administrator provides opportunities for consultation by elected officials of those State and local gov-

ernments that would provide the non-Federal funds for, or that would be directly affected by, proposed Federal financial assistance from, or direct Federal development by, GSA.

(b) If a State adopts a process under the Order to review and coordinate proposed Federal financial assistance and direct Federal development, the Administrator, to the extent permitted by law:

(1) Uses the State process to determine official views of State and local elected officials;

(2) Communicates with State and local elected officials as early in a program planning cycle as is reasonably feasible to explain specific plans and actions;

(3) Makes efforts to accommodate State and local elected officials' concerns with proposed Federal financial assistance and direct Federal development that are communicated through the State process;

(4) Allows the States to simplify and consolidate existing federally required State plan submissions;

(5) Where State planning and budgeting systems are sufficient and where permitted by law, encourages the substitution of State plans for federally required State plans;

(6) Seeks the coordination of views of affected State and local elected officials in one State with those of another State when proposed Federal financial assistance or direct Federal development has an impact on interstate metropolitan urban centers or other interstate areas; and

(7) Supports State and local governments by discouraging the reauthorization or creation of any planning organization which is federally-funded, which has limited purpose, and which is not adequately representative of, or accountable to, State or local elected officials.

§ 101-6.2105 What is the Administrator's obligation with respect to Federal interagency coordination?

The Administrator, to the extent practicable, consults with and seeks advice from all other substantially affected Federal departments and agencies in an effort to assure full coordination between such agencies and GSA

Federal Property Management Regulations

§ 101-6.2109

regarding programs and activities covered under these regulations.

§ 101-6.2106 What procedures apply to the selection of programs and activities under these regulations?

(a) A State may select any program or activity published in the FEDERAL REGISTER in accordance with § 101-6.2103 of this part for intergovernmental review under these regulations. Each State, before selecting programs and activities, shall consult with local elected officials.

(b) Each State that adopts a process shall notify the Administrator of the GSA programs and activities selected for that process.

(c) A State may notify the Administrator of changes in its selections at any time. For each change, the State shall submit to the Administrator an assurance that the State has consulted with elected local elected officials regarding the change. GSA may establish deadlines by which States are required to inform the Administrator of changes in their program selections.

(d) The Administrator uses a State's process as soon as feasible, depending on individual programs and activities, after the Administrator is notified of its selections.

§ 101-6.2107 How does the Administrator communicate with State and local officials concerning GSA's programs and activities?

(a) [Reserved]

(b) The Administrator provides notice to directly affected State, areawide, regional, and local entities in a State of proposed Federal financial assistance or direct Federal development if:

(1) The State has not adopted a process under the Order; or

(2) The assistance or development involves a program or activity not selected for the State process.

NOTE: This notice may be made by publication in the FEDERAL REGISTER or other appropriate means, which GSA in its discretion deems appropriate.

§ 101-6.2108 How does the Administrator provide States an opportunity to comment on proposed Federal financial assistance and direct Federal development?

(a) Except in unusual circumstances, the Administrator gives State processes or directly affected State, areawide, regional and local officials and entities at least:

(1) [Reserved]

(2) 60 days from the date established by the Administrator to comment on proposed direct Federal development or Federal financial assistance.

(b) This section also applies to comments in cases in which the review, coordination, and communication with GSA have been delegated.

§ 101-6.2109 How does the Administrator receive and respond to comments?

(a) The Administrator follows the procedures in § 101-6.2110 if:

(1) A State office or official is designated to act as a single point of contact between a State process and all Federal agencies, and

(2) That office or official transmits a State process recommendation for a program selected under § 101-6.2106.

(b)(1) The single point of contact is not obligated to transmit comments from State, areawide, regional or local officials and entities where there is no State process recommendation.

(2) If a State process recommendation is transmitted by a single point of contact, all comments from State, areawide, regional, and local officials and entities that differ from it must also be transmitted.

(c) If a State has not established a process, or is unable to submit a State process recommendation, State, areawide, regional and local officials and entities may submit comments to GSA.

(d) If a program or activity is not selected for a State process, State, areawide, regional and local officials and entities may submit comments to GSA. In addition, if a State process recommendation for a nonselected program or activity is transmitted to GSA

§ 101-6.2110

41 CFR Ch. 101 (7-1-01 Edition)

by the single point of contact, the Administrator follows the procedures of §101-6.2110 of this part.

(e) The Administrator considers comments which do not constitute a State process recommendation submitted under these regulations, and for which the Administrator is not required to apply the procedures of §101-6.2110 of this part, when such comments are provided by a single point of contact, or directly to GSA by a commenting party.

§ 101-6.2110 How does the Administrator make efforts to accommodate intergovernmental concerns?

(a) If a State process provides a State process recommendation to GSA through its single point of contact, the Administrator either:

- (1) Accepts the recommendation;
- (2) Reaches a mutually agreeable solution with the State process; or
- (3) Provides the single point of contact with such written explanation of its decision, as the Administrator in his or her discretion deems appropriate. The Administrator may also supplement the written explanation by providing the explanation to the single point of contact by telephone, other telecommunication, or other means.

(b) In any explanation under paragraph (a)(3) of this section, the Administrator informs the single point of contact that:

- (1) GSA will not implement its decision for at least ten days after the single point of contact receives the explanation; or
- (2) The Administrator has reviewed the decision and determined that, because of unusual circumstances, the waiting period of at least ten days is not feasible.
- (c) For purposes of computing the waiting period under paragraph (b)(1) of this section, a single point of contact is presumed to have received written notification 5 days after the date of mailing of such notification.

§ 101-6.2111 What are the Administrator's obligations in interstate situations?

(a) The Administrator is responsible for:

(1) Identifying proposed Federal financial assistance and direct Federal development that have an impact on interstate areas;

(2) Notifying appropriate officials and entities in States which have adopted a process and which have selected a GSA program or activity;

(3) Making efforts to identify and notify the affected State, areawide, regional, and local officials and entities in those States that have not adopted a process under the Order or have not selected a GSA program or activity; and

(4) Responding pursuant to §101-6.2110 of this part if the Administrator receives a recommendation from a designated areawide agency transmitted by a single point of contact, in cases in which the review, coordination, and communication with GSA have been delegated.

(b) The Administrator uses the procedures in §101-6.2110 if a State process provides a State process recommendation to GSA through a single point of contact.

§ 101-6.2112 How may a State simplify, consolidate, or substitute federally required State plans?

(a) As used in this section:

(1) *Simplify* means that a State may develop its own format, choose its own submission date, and select the planning period for a State plan.

(2) *Consolidate* means that a State may meet statutory and regulatory requirements by combining two or more plans into one document and that the State can select the format, submission date, and planning period for the consolidated plan.

(3) *Substitute* means that a State may use a plan or other document that it has developed for its own purposes to meet Federal requirements.

(b) If not inconsistent with law, a State may decide to try to simplify, consolidate, or substitute federally required State plans without prior approval by the Administrator.

(c) The Administrator reviews each State plan that a State has simplified, consolidated, or substituted and accepts the plan only if its contents meet Federal requirements.

Federal Property Management Regulations

§ 101-8.300

§ 101-6.2113 **May the Administrator waive any provision of these regulations?**

In an emergency, the Administrator may waive any provision of these regulations.

Subparts 101-6.22—101-6.48 [Reserved]

Subpart 101-6.49—Illustrations

AUTHORITY: Sec. 205(c), 63 Stat. 390; 40 U.S.C. 486(c).

§ 101-6.4900 **Scope of subpart.**

This subpart contains illustrations prescribed for use in connection with the subject matter covered in part 101-6.

[37 FR 20542, Sept. 30, 1972]

§ 101-6.4901 **[Reserved]**

§ 101-6.4902 **Format of certification required for budget submissions of estimates of obligations in excess of \$100,000 for acquisitions of real and related personal property.**

NOTE: The illustration in § 101-6.4902 is filed as part of the original document.

[37 FR 20542, Sept. 30, 1972]

PART 101-8—NONDISCRIMINATION IN FEDERAL FINANCIAL ASSISTANCE PROGRAMS

Subparts 101-8.1—101-8.2 [Reserved]

Subpart 101-8.3—Discrimination Prohibited on the Basis of Handicap

Sec.

- 101-8.300 Purpose and applicability.
- 101-8.301 Definitions.
- 101-8.302 General prohibitions.
- 101-8.303 Specific prohibitions.
- 101-8.304 Effect of State or local law or other requirements and effect of employment opportunities.
- 101-8.305 Employment practices prohibited.
- 101-8.306 Reasonable accommodation.
- 101-8.307 Employment criteria.
- 101-8.308 Preemployment inquiries.
- 101-8.309 Program accessibility.
- 101-8.310 New construction.
- 101-8.311 Historic preservation programs.
- 101-8.312 Procedures.
- 101-8.313 Self-evaluation.

Subparts 101-8.4—101-8.6 [Reserved]

Subpart 101-8.7—Discrimination Prohibited on the Basis of Age

- 101-8.700 Purpose of the Age Discrimination Act of 1975.
- 101-8.701 Scope of General Services Administration's age discrimination regulation.
- 101-8.702 Applicability.
- 101-8.703 Definitions of terms.
- 101-8.704 Rules against age discrimination.
- 101-8.705 Definition of normal operation and statutory objective.
- 101-8.706 Exceptions to the rules against age discrimination.
- 101-8.706-1 Normal operation or statutory objective of any program or activity.
- 101-8.706-2 Reasonable factors other than age.
- 101-8.707 Burden of proof.
- 101-8.708 Affirmative action by recipient.
- 101-8.709 Special benefits for children and the elderly.
- 101-8.710 Age distinctions contained in General Services Administration regulation.
- 101-8.711 General responsibilities.
- 101-8.712 Notice to subrecipients and beneficiaries.
- 101-8.713 Assurance of compliance and recipient assessment of age distinctions.
- 101-8.714 Information requirements.
- 101-8.715 Compliance reviews.
- 101-8.716 Complaints.
- 101-8.717 Mediation.
- 101-8.718 Investigation.
- 101-8.719 Prohibition against intimidation or retaliation.
- 101-8.720 Compliance procedure.
- 101-8.721 Hearings.
- 101-8.722 Decisions and notices.
- 101-8.723 Remedial action by recipient.
- 101-8.724 Exhaustion of administrative remedies.
- 101-8.725 Alternate funds disbursement.

AUTHORITY: Sec. 205(c), 63 Stat. 390; 40 U.S.C. 486(c).

SOURCE: 47 FR 25337, June 11, 1982, unless otherwise noted.

Subparts 101-8.1—101-8.2 [Reserved]

Subpart 101-8.3—Discrimination Prohibited on the Basis of Handicap

§ 101-8.300 **Purpose and applicability.**

(a) The purpose of this subpart is to implement section 504 of the Rehabilitation Act of 1973, as amended, which prohibits discrimination on the basis of

§ 101-8.301

41 CFR Ch. 101 (7-1-01 Edition)

handicap in any program or activity receiving Federal financial assistance.

(b) This subpart applies to each recipient or subrecipient of Federal assistance from GSA and to each program or activity that receives or benefits from assistance.

§ 101-8.301 Definitions.

(a) *Section 504* means section 504 of the Rehabilitation Act of 1973, Public Law 93-112, as amended by the Rehabilitation Act Amendments of 1974, Public Law 93-516, 29 U.S.C. 794.

(b) *Handicapped person* means any person who has a physical or mental impairment which substantially limits one or more major life activities, has a record of such impairments, or is regarded as having such an impairment.

(c) As used in paragraph (b) of this section, the phrase:

(1) *Physical or mental impairment* means:

(i) Any physiological disorder or condition, cosmetic disfigurement, or anatomical loss affecting one or more of the following body systems: Neurological; musculoskeletal; special sense organs; respiratory, including speech organs; cardiovascular; reproductive, digestive, genitourinary; hemic and lymphatic; skin; and endocrine; or

(ii) Any mental or psychological disorder, such as mental retardation, organic brain syndrome, emotional or mental illness, and specific learning disabilities. The term "physical or mental impairment" includes, but is not limited to, such diseases and conditions as orthopedic, visual, speech and hearing impairments, cerebral palsy, epilepsy, muscular dystrophy, multiple sclerosis, cancer, heart disease, diabetes, mental retardation, emotional illness and drug addiction and alcoholism, when current use of drugs and/or alcohol is not detrimental to or interferes with the employee's performance, nor constitutes a direct threat to property or safety of others.

(2) *Major life activities* means functions such as caring for one's self, performing manual tasks, walking, seeing, hearing, speaking, breathing, learning and working.

(3) *Has a record of such an impairment* means has a history of, or has been misclassified as having, a mental or

physical impairment that substantially limits one or more major life activities.

(4) *Is regarded as having an impairment* means:

(i) Has a physical or mental impairment that does not substantially limit major life activities but that is treated by a recipient as constituting such a limitation;

(ii) Has a physical or mental impairment that substantially limits major life activities only as a result of the attitudes of others toward such impairment; or

(iii) Has none of the impairments defined in paragraphs (c)(1) (i) and (ii) of this section, but is treated by a recipient as having such an impairment.

(d) *Qualified handicapped person* means:

(1) With respect to employment, a handicapped person who, with reasonable accommodation, can perform the essential functions of the job in question;

(2) With respect to public preschool, elementary, secondary, or adult education services, a handicapped person:

(i) Of an age during which nonhandicapped persons are provided such services;

(ii) Of any age during which it is mandatory under state law to provide such services to handicapped persons; or

(iii) To whom a state is required to provide a free appropriate public education under section 612 of the Education for All Handicapped Children Act of 1975, Public Law 94-142.

(3) With respect to postsecondary and vocational education services, a handicapped person who meets the academic and technical standards requisite to admission or participation in the recipient's education program or activity; and

(4) With respect to other services, a handicapped person who meets the essential eligibility requirements for the receipt of such services.

(e) *Handicap* means condition or characteristic that renders a person a handicapped person as defined in paragraph (b) of this section.

The definitions set forth in §101-6.216, to the extent not inconsistent with

Federal Property Management Regulations

§ 101-8.303

this subpart, are made applicable to and incorporated into this subpart.

§ 101-8.302 General prohibitions.

No qualified handicapped persons shall, on the basis of handicap, be excluded from participation in, be denied the benefits of, or otherwise be subjected to discrimination under any program or activity that receives or benefits from Federal assistance from GSA.

§ 101-8.303 Specific prohibitions.

(a) A recipient, in providing any aid, benefit, or service, may not directly or through contractual, licensing, or other arrangements, on the basis of handicap:

(1) Deny a qualified person the opportunity to participate in or benefit from the aid, benefit, or service;

(2) Afford a qualified handicapped person an opportunity to participate in or benefit from the aid, benefit, or service that is not equal to that afforded others;

(3) Provide a qualified handicapped person with an aid, benefit, or service that is not as effective in affording equal opportunity to obtain the same result, to gain the same benefit, or to reach the same level of achievement as that provided others;

(4) Provide different or separate aid, benefits, or services to handicapped persons or to any class of handicapped persons than is provided to others unless the action is necessary to provide qualified handicapped persons with aid, benefits, or services that are as effective as those provided to others;

(5) Aid or perpetuate discrimination against a qualified handicapped person by providing significant assistance to an agency, organization, or person that discriminates on the basis of handicap in providing any aid, benefit, or services to beneficiaries of the recipient's program;

(6) Deny a qualified handicapped person the opportunity to participate as a member of planning committees, advisory boards, or other groups; or

(7) Otherwise limit a qualified handicapped person in the enjoyment of any right, privilege, advantage, or opportunity enjoyed by others receiving the aid, benefit, or service.

(b) For purposes of this subpart, aids, benefits, and services, to be equally effective, are not required to produce the identical result or level of achievement for handicapped and nonhandicapped persons, but must afford handicapped persons equal opportunity to obtain the same result, to gain the same benefit, or to reach the same level of achievement in the most integrated setting appropriate to the person's needs.

(c) Despite the existence of permissible separate or different programs or activities, a recipient may not deny a qualified handicapped person the opportunity to participate in programs or activities that are not separate or different.

(d) A recipient may not, directly or through contractual or other arrangements, use criteria or methods of administration that:

(1) Have the effect of subjecting qualified handicapped persons to discrimination on the basis of handicap;

(2) Have the purpose or effect of defeating or substantially impairing accomplishment of the objectives of the recipient's program with respect to handicapped persons; or

(3) Perpetuate the discrimination of another recipient if both recipients are subject to common administrative control or are agencies of the same State.

(e) In determining the site of a facility, an applicant for assistance or a recipient may not make selections that:

(1) Have the effect of excluding handicapped persons from, denying them the benefits of, or otherwise subjecting them to discrimination under any program or activity that receives Federal assistance from GSA; or

(2) Have the purpose or effect of defeating or substantially impairing the accomplishment of the objectives of the program or activity with respect to handicapped persons.

(f) As used in this section, the aid, benefit, or service provided under a program or activity receiving or benefiting from Federal assistance includes any aid, benefit, or service provided in or through a facility that has been constructed, expanded, altered, leased, or rented, or otherwise acquired, in whole or in part, with Federal assistance.

(g) The exclusion of nonhandicapped persons from the benefits of a program limited by Federal statute or Executive order to handicapped persons or the exclusion of a specific class of handicapped persons from a program limited by Federal statute or Executive order to a different class of handicapped persons is not prohibited by this subpart.

(h) Recipients shall take appropriate steps to ensure that communications with the donees, applicants, employees, and handicapped persons participating in federally assisted programs and activities or receiving aid, benefits, or services are available to persons with impaired vision and hearing. Examples of communications methods include: Telecommunication devices for the deaf (TDD's), other telephonic devices, provision of braille materials, readers, and qualified sign language interpreters.

(i) The enumeration of specific forms of prohibited discrimination in this section does not limit the generality of the prohibition in § 101-8.302 of this subpart.

§ 101-8.304 Effect of State or local law or other requirements and effect of employment opportunities.

(a) The obligation to comply with this subpart is not obviated or alleviated by the existence of any State or local law or other requirement that, on the basis of handicap, imposes prohibitions or limits upon the eligibility of qualified handicapped persons to receive services or to practice any occupation or profession.

(b) The obligation to comply with this subpart is not obviated or alleviated because employment opportunities in any occupation or profession are or may be more limited for handicapped persons than for nonhandicapped persons.

§ 101-8.305 Employment practices prohibited.

(a) No qualified handicapped person shall, on the basis of handicap, be subjected to employment discrimination under any program or activity to which this subpart applies.

(b) A recipient shall make all decisions concerning employment under

any program or activity to which this subpart applies in a manner which ensures that discrimination on the basis of handicap does not occur and may not limit, segregate, or classify applicants or employees in any way that adversely affects their opportunities or status because of handicap.

(c) A recipient may not participate in a contractual or other relationship that has the effect of subjecting qualified handicapped applicants or employees to discrimination prohibited by this subpart. The relationships referred to in this paragraph include relationships with employment and referral agencies, labor unions, organizations providing or administering fringe benefits to employees of the recipient, and organizations providing training and apprenticeship programs.

(d) The provisions of this subpart apply to:

(1) Recruitment, advertising, and processing of applications for employment;

(2) Hiring, upgrading, promotion, award of tenure, demotion, transfer, layoff, termination, right of return from layoff, and rehiring;

(3) Rates of pay or any other form of compensation and changes in compensation;

(4) Job assignments, job classifications, organizational structures, position descriptions, lines of progression, and seniority lists;

(5) Leaves of absence, sick or otherwise;

(6) Fringe benefits available by virtue of employment, whether administered by the recipient or not;

(7) Selection and provision of financial support for training, including apprenticeship, professional meetings, conferences, and other related activities, and selection for leaves of absence to pursue training;

(8) Employer-sponsored activities, including social or recreational programs; and

(9) Any other term, condition, or privilege of employment.

(e) A recipient's obligation to comply with this subpart is not affected by any inconsistent term of any collective bargaining agreement to which it is a party.

Federal Property Management Regulations

§ 101-8.308

§ 101-8.306 Reasonable accommodation.

(a) A recipient shall make reasonable accommodation to the known physical or mental limitations of an otherwise qualified handicapped applicant or employee unless the recipient can demonstrate that the accommodation would impose an undue hardship on the operation of its program.

(b) Reasonable accommodation may include:

(1) Making facilities used by employees readily accessible to and usable by handicapped persons; and

(2) Job restructuring; part-time or modified work schedules; acquisition or modification of equipment or devices, such as telecommunications devices or other telephonic devices for hearing impaired persons; provision of reader or qualified sign language interpreters; and other similar actions. These actions are to be taken either upon request of the handicapped employee or, if not so requested, upon the recipient's own initiative, after consultation with and approval by the handicapped person.

(c) In determining, under paragraph (a) of this section, whether an accommodation would impose an undue hardship on the operation of a recipient's program, factors to be considered include:

(1) The overall size of the recipient's program with respect to number of employees, number and type of facilities, and size of budget;

(2) The type of the recipient's operation, including the composition and structure of the recipient's work force; and

(3) The nature and cost of the accommodation needed.

(d) A recipient may not deny an employment opportunity to a qualified handicapped employee or applicant if the basis for the denial is the need to make reasonable accommodation to the physical or mental limitations of the employee or applicant.

§ 101-8.307 Employment criteria.

(a) A recipient may not use an employment test or other selection criterion that screens out or tends to screen out handicapped persons unless the test score or other selection cri-

terion, as used by the recipient, is shown to be job-related for the position in question.

(b) A recipient shall ensure that employment tests are adapted for use by persons who have handicaps that impair sensory, manual, or speaking skills except where those skills are the factors that the test purports to measure.

§ 101-8.308 Preemployment inquiries.

(a) Except as provided in paragraphs (b) and (c) of this section, a recipient may not conduct a preemployment medical examination or may not make preemployment inquiries of an applicant as to whether the applicant is a handicapped person or as to the nature or severity of a handicap. A recipient may, however, make preemployment inquiries into an applicant's ability to perform job-related functions.

(b) When a recipient is taking remedial action to correct the effects of past discrimination, or is taking voluntary action to overcome the effects of conditions that resulted in limited participation in its federally assisted program or activity, or when a recipient is taking affirmative action under section 503 of the Rehabilitation Act of 1973, as amended, the recipient may invite applicants for employment to indicate whether, and to what extent, they are handicapped provided that:

(1) The recipient states clearly on any written questionnaire used for this purpose or makes clear orally, if no written questionnaire is used, that the information requested is intended for use solely in connection with its remedial action obligations or its voluntary or affirmative action efforts; and

(2) The recipient states clearly that the information is requested on a voluntary basis, that it will be kept confidential as provided in paragraph (d) of this section, that refusal to provide it will not subject the applicant or employee to any adverse treatment, and that it will be used only in accordance with this subpart.

(c) This section does not prohibit a recipient from conditioning an offer of employment on the results of a medical examination conducted prior to the employee's entrance on duty provided that all entering employees are

subjected to the examination regardless of handicap or absence of handicap and results of the examination are used only in accordance with the requirements of this subpart.

(d) Information obtained in accordance with this section concerning the medical condition or history of the applicant shall be collected and maintained on separate forms that are to be accorded confidentiality as medical records, except that:

(1) Supervisors and managers may be informed of restrictions on the work or duties of handicapped persons and of necessary accommodations;

(2) First aid and safety personnel may be informed, where appropriate, if the condition might require emergency treatment; and

(3) Government officials investigating compliance with section 504 of the Rehabilitation Act of 1973, as amended, shall be provided relevant information upon request.

§ 101-8.309 Program accessibility.

(a) *General.* No handicapped person shall, because a recipient's facilities are inaccessible to or unusable by handicapped persons, be denied the benefits of, be excluded from participation in, or be subjected to discrimination under any program or activity that receives or benefits from Federal assistance from GSA.

(b) *Program accessibility.* A recipient shall operate any program or activity to which this subpart applies so that the program or activity, when viewed in its entirety, is readily accessible to and usable by handicapped persons. This paragraph does not require a recipient to make each of its existing facilities or every part of a facility accessible to and usable by handicapped persons.

(c) *Methods.* A recipient may comply with the requirement of paragraph (a) of this section through such means as acquisition or redesign of equipment, such as telecommunications devices or other telephonic devices for the hearing impaired; reassignment of classes or other services to alternate sites which have accessible buildings; assignment of aides to beneficiaries, such as readers for the blind or qualified sign language interpreters for the hear-

ing impaired when appropriate; home visits; delivery of health, welfare, or other social services at alternate accessible sites; alterations of existing facilities and construction of new facilities in conformance with the requirements of § 101-8.310; or any other methods that result in making its program or activity accessible to handicapped persons. A recipient is not required to make structural changes in existing facilities where other methods are effective in achieving compliance with paragraph (a) of this section. In choosing among available methods for meeting the requirement of paragraph (a) of this section, a recipient shall give priority to those methods that offer programs and activities to handicapped persons in the most integrated setting appropriate.

(d) *Small service providers.* If a recipient with fewer than 15 employees finds, after consultation with a handicapped person seeking its services, that there is no available method of complying with paragraph (a) of this section other than making a significant alteration in its existing facilities, the recipient may, as an alternative, refer the handicapped person to other providers of those services that are accessible at no additional cost to the handicapped person.

(e) *Time period.* A recipient shall comply with the requirement of paragraph (a) of this section within 60 days of the effective date of this subpart, except that where structural changes in facilities are necessary, the changes are to be made as expeditiously as possible, but in no event later than 3 years after the effective date of this subpart.

(f) *Transition plan.* In the event that structural changes to facilities are necessary to meet the requirements of paragraph (a) of this section, a recipient shall develop, within 6 months of the effective date of this subpart, a transition plan setting forth the steps necessary to complete the changes. The plan shall be developed with the assistance of interested persons, including handicapped persons or organizations representing handicapped persons, and the plan must meet with the approval of the Director of Civil Rights, GSA. A copy of the transition plan shall be

Federal Property Management Regulations

§ 101-8.311

made available for public inspection. At a minimum, the plan shall:

(1) Identify physical obstacles in the recipient's facilities that limit the accessibility to and usability by handicapped persons of its program or activity;

(2) Describe in detail the methods that will be used to make the facilities accessible;

(3) Specify the schedule for taking the steps necessary to achieve full program accessibility and, if the time period or the transition plan is longer than 1 year, identify steps that will be taken during each year of the transition period; and

(4) Indicate the person responsible for implementation of the plan.

(g) *Notice.* The recipient shall adopt and implement procedures to ensure that interested persons, including persons with impaired vision or hearing, can obtain information concerning the existence and location of services, activities, and facilities that are accessible to, and usable by, handicapped persons.

§ 101-8.310 New construction.

(a) *Design and construction.* Each facility or part of a facility constructed by, on behalf of, or for the use of a recipient shall be designed and constructed in a manner that the facility or part of the facility is readily accessible to, and usable by, handicapped persons, if the construction began after the effective date of this subpart.

(b) *Alteration.* Each facility or part of a facility which is altered by, on behalf of, or for the use of a recipient after the effective date of this subpart in a manner that affects or could affect the usability of the facility or part of the facility shall, to the maximum extent feasible, be altered in a manner that the altered portion of the facility is readily accessible to and usable by handicapped persons.

(c) *GSA Accessibility Standard.* Design, construction, or alteration of facilities shall be in conformance with the "GSA Accessibility Standard," PBS (PCD): DG6, October 14, 1980. A copy of the standard can be obtained through the Business Service Centers, General Services Administration, National Capital Region, 7th and D Streets, SW.,

Washington, DC 20407 or Regional Business Service Centers, Region 1, John W. McCormack, Post Office and Courthouse, Boston, Massachusetts 02109; Region 2, 26 Federal Plaza, New York, New York 10007; Region 3, Ninth and Market Streets, Philadelphia, Pennsylvania 19107; Region 4, 75 Spring Street, SW., Atlanta, Georgia 30303; Region 5, 230 South Dearborn, Chicago, Illinois 60604; Region 6, 1500 East Bannister Road, Kansas City, Missouri 64131; Region 7, 819 Taylor Street, Fort Worth, Texas 76102; Region 8, Building 41, Denver Federal Center, Denver, Colorado 80225; Region 9, 525 Market Street, San Francisco, California 94105; Region 10, GSA Center, Auburn, Washington 98002.

In cases of practical difficulty, unnecessary hardship, or extreme differences, exceptions may be granted from the literal requirements of the above-mentioned standard, as defined in §§ 101-19.604 and 101-19.605 ("Exceptions" and "Waiver or modification of standards"), but only when it is clearly evident that equal facilitation and protection are thereby secured.

§ 101-8.311 Historic preservation programs.

(a) *Definitions.* For purposes of this section, the term:

(1) *Historic preservation programs* means programs receiving Federal financial assistance that has preservation of historic properties as a primary purpose.

(2) *Historic properties* means those properties that are listed or eligible for listing in the National Register of Historic Places.

(3) *Substantial impairment* means a permanent alteration that results in a significant loss of the integrity of finished materials, design quality or special character.

(b) *Obligation*—(1) *Program accessibility.* In the case of historic preservation programs, program accessibility means that, when viewed in its entirety, a program is readily accessible to and usable by handicapped persons.

This paragraph does not necessarily require a recipient to make each of its existing historic properties or every part of an historic property accessible to and usable by handicapped persons.

§ 101-8.312

Methods of achieving program accessibility include:

- (i) Making physical alterations which enable handicapped persons to have access to otherwise inaccessible areas or features of historic properties;
- (ii) Using audio-visual materials and devices to depict otherwise inaccessible areas or features of historic properties;
- (iii) Assigning persons to guide handicapped persons into or through otherwise inaccessible portions of historic properties;
- (iv) Adopting other innovative methods to achieve program accessibility.

Because the primary benefit of an historic preservation program is the experience of the historic property itself, in taking steps to achieve program accessibility, recipients shall give priority to those means which make the historic property, or portions thereof, physically accessible to handicapped individuals.

(2) *Waiver of accessibility standards.* Where program accessibility cannot be achieved without causing a substantial impairment of significant historic features, the Administrator may grant a waiver of the program accessibility requirement. In determining whether program accessibility can be achieved without causing a substantial impairment, the Administrator shall consider the following factors:

- (i) Scale of property, reflecting its ability to absorb alterations;
- (ii) Use of the property, whether primarily for public or private purpose;
- (iii) Importance of the historic features of the property to the conduct of the program; and
- (iv) Cost of alterations in comparison to the increase in accessibility.

The Administrator shall periodically review any waiver granted under this section and may withdraw it if technological advances or other changes so warrant.

(c) *Advisory Council comments.* Where the property is federally owned or where Federal funds may be used for alterations, the comments of the Advisory Council on Historic Preservation shall be obtained when required by section 106 of the National Historic Preservation Act of 1966, as amended (16 U.S.C. 470), and 36 CFR part 800, prior

41 CFR Ch. 101 (7-1-01 Edition)

to effectuation of structural alterations.

§ 101-8.312 Procedures.

The procedural provisions of title VI of the Civil Rights Act of 1964 are adopted and stated in §§ 101-6.205-101-6.215 and apply to this subpart. (Sec. 205(c), 63 Stat. 390; 40 U.S.C. 486(c).)

§ 101-8.313 Self-evaluation.

(a) *Procedures.* Each recipient shall, within one year of the effective date of this part:

(1) Whenever possible, evaluate, with the assistance of interested persons, including handicapped persons or organizations representing handicapped persons, its current policies and practices and the effects thereof that do not or may not meet the requirements of this part;

(2) Modify any policies and practices which do not or may not meet the requirements of this part; and

(3) Take appropriate remedial steps to eliminate the effects of discrimination which resulted or may have resulted from adherence to these questionable policies and practices.

(b) *Availability of self-evaluation and related materials.* Recipients shall maintain on file, for at least three years following its completion, the evaluation required under paragraph (a) of this section, and shall provide to the Director, upon request, a description of any modifications made under paragraph (a)(2) of this section and of any remedial steps taken under paragraph (a)(3) of this section.

Subparts 101-8.4—101-8.6 [Reserved]

Subpart 101-8.7—Discrimination Prohibited on the Basis of Age

AUTHORITY: 42 U.S.C. 6101 *et seq.*

SOURCE: 50 FR 23412, June 4, 1985, unless otherwise noted.

§ 101-8.700 Purpose of the Age Discrimination Act of 1975.

The Age Discrimination Act of 1975, as amended, prohibits discrimination

Federal Property Management Regulations

§ 101-8.703

on the basis of age in programs or activities receiving Federal financial assistance.

§ 101-8.701 Scope of General Services Administration's age discrimination regulation.

This regulation sets out General Services Administration's (GSA) policies and procedures under the Age Discrimination Act of 1975, as amended, in accordance with 45 CFR part 90. The Act and the Federal regulation permits Federal financial assistance programs and activities to continue to use certain age distinctions and factors other than age which meet the requirements of the Act and its implementing regulations.

§ 101-8.702 Applicability.

(a) The regulation applies to each GSA recipient and to each program or activity operated by the recipient that benefits from GSA Federal financial assistance.

(b) The regulations does not apply to:

(1) An age distinction contained in that part of Federal, State, local statute or ordinance adopted by an elected, general purpose legislative body that:

- (i) Provides any benefits or assistance to persons based on age;
- (ii) Establishes criteria for participation in age-related terms; or
- (iii) Describes intended beneficiaries or target groups in age-related terms.

(2) Any employment practice of any employer, employment agency, labor organization or any labor-management apprenticeship training program, except for any program or activity receiving Federal financial assistance for public service employment under the Comprehensive Employment and Training Act (CETA) (29 U.S.C. 801 *et seq.*).

§ 101-8.703 Definitions of terms.

(a) As used in these regulations, the term: *Act* means the Age Discrimination Act of 1975, as amended (title III of Pub. L. 94-135).

(b) *Action* means any act, activity, policy, rule, standard, or method of administration.

(c) *Age* means how old a person is, or the number of years from the date of a person's birth.

(d) *Age distinction* means any action using age or an age-related term.

(e) *Age-related term* means a word or words that imply a particular age or range or ages (for example, *children, adult, older person*, but not *student*).

(f) *Agency* means a Federal department or agency empowered to extend Federal financial assistance.

(g) Agency Responsible Officials:

(1) *Administrator* means the Administrator of General Services.

(2) *Director, Office of Civil Rights* means the individual responsible for managing the agency's nondiscrimination Federal financial assistance program, or his or her designee.

(h) *Federal financial assistance* means (1) grants and loans of Federal funds, (2) the grant or donation of Federal property and interests in property, (3) the services of Federal personnel, (4) the sale and lease of, and the permission to use (on other than a casual or transient basis), Federal property or any interest in such property without consideration or at a nominal consideration, or at a consideration which is reduced for the purposes of assisting the recipient, or in recognition of the public interest to be served by such sale or lease to the recipient, and (5) any Federal agreement, arrangement, or other contract which has as one of its purposes the provision of assistance.

(i) *GSA* means the United States General Services Administration.

(j) *Primary recipient* means any recipient which is authorized or required to extend Federal financial assistance to another recipient for the purpose of carrying out a program.

(k) *Recipient* means any State, political subdivision of any State, or instrumentality of any State or political subdivision, any public or private agency, institution, or organization, or any other entity, or any individual, in any State, to whom Federal financial assistance is extended, directly or through another recipient, for any program, including any successor, assign, or transferee thereof, but such term does not include any ultimate beneficiary under any such program.

§ 101-8.704

41 CFR Ch. 101 (7-1-01 Edition)

§ 101-8.704 Rules against age discrimination.

The rules stated in this section are limited by the exceptions contained in § 101-8.706 of this regulation

(a) *General rule.* No person in the United States may on the basis of age, be excluded from participation, be denied the benefits of, or be subjected to discrimination under any program or activity receiving Federal financial assistance from GSA.

(b) *Specific rules.* A recipient may not, in any program or activity receiving Federal financial assistance, directly or through contractual licensing, or other arrangement, use age distinctions or take any other actions that have the effect on the basis of age, of:

(1) Excluding individuals from participating in, denying them the benefits of, or subjecting them to discrimination under a program or activity receiving Federal financial assistance; or

(2) Denying or limiting individual opportunity to participate in any program or activity receiving Federal financial assistance.

(c) The forms of age discrimination listed in paragraph (b) of this section are not necessarily a complete list.

§ 101-8.705 Definition of normal operation and statutory objective.

The terms *normal operation* and *statutory objective* are defined as follows:

(a) *Normal operation* means the operation of a program or activity without significant changes that would inhibit meeting objectives.

(b) *Statutory objective* means any purpose of a program or activity expressly stated in any Federal, State, or local statute or ordinance adopted by an elected, general purpose legislative body.

§ 101-8.706 Exceptions to the rules against age discrimination.

§ 101-8.706-1 Normal operation or statutory objective of any program or activity.

A recipient is permitted to take an action, otherwise prohibited, if the action reasonably takes into account age as a factor necessary to the normal operation or achievement of any statutory objective of a program or activity.

An action reasonably takes into account age as a factor if:

(a) Age is used as a measure or approximation of one or more other characteristics; and

(b) The other characteristic must be measured or approximated for the normal operation of the program or activity to continue, or to achieve any statutory objective of the program or activity; and

(c) The other characteristic can be reasonably measured or approximated by the use of age; and

(d) The other characteristic is impractical to measure directly on an individual basis.

§ 101-8.706-2 Reasonable factors other than age.

(a) A recipient is permitted to take an action, otherwise prohibited by § 101-8.706-1, which is based on something other than age, even though the action may have a disproportionate effect on persons of different ages.

(b) An action may be based on a factor other than age only if the factor bears a direct and substantial correlation to the normal operation of the program or activity or to the achievement of a statutory objective.

§ 101-8.707 Burden of proof.

The burden of proving that an age distinction or other action falls within the exceptions outlined in § 101-8.706 is the recipient's.

§ 101-8.708 Affirmative action by recipient.

Even in the absence of a finding of age discrimination, a recipient may take affirmative action to overcome the effects resulting in limited participation in the recipient's program or activity.

§ 101-8.709 Special benefits for children and the elderly.

If a recipient's program provides special benefits to the elderly or to children, such use of age distinctions is presumed to be necessary to the normal operation of the program, notwithstanding the provisions of § 101-8.705.

Federal Property Management Regulations

§ 101-8.714

§ 101-8.710 Age distinctions contained in General Services Administration regulation.

Any age distinctions contained in a rule or regulation issued by GSA are presumed to be necessary to the achievement of a statutory objective of the program to which the rule or regulation applies. The GSA regulation 41 CFR 101-44.207(a) (3) through (27), describes specific Federal financial assistance programs which provide assistance to all age groups. However, the “Child Care Center” program servicing children through age 14, and “Programs for Older Individuals”, are the only two programs where age distinctions are provided.

§ 101-8.711 General responsibilities.

Each recipient of Federal financial assistance from GSA is responsible for ensuring that its programs and activities comply with the Act and this regulation and must take steps to eliminate violations of the Act. A recipient is also responsible for maintaining records, providing information, and affording GSA access to its records to the extent GSA finds necessary to determine whether the recipient is complying with the Act and this regulation.

§ 101-8.712 Notice to subrecipients and beneficiaries.

(a) If a primary recipient passes on Federal financial assistance from GSA to subrecipients, the primary recipient provides to subrecipients, written notice of their obligations under the Act and this regulation.

(b) Each recipient makes necessary information about the Act and this regulation available to its program beneficiaries to inform them about the protections against discrimination provided by the Act and this regulation.

§ 101-8.713 Assurance of compliance and recipient assessment of age distinctions.

(a) Each recipient of Federal financial assistance from GSA signs a written assurance as specified by GSA that it intends to comply with the Act and this regulation.

(b) Recipient assessment of age distinctions.

(1) As part of a compliance review under § 101-8.715 or complaint investigation under § 101.8.718, GSA may require a recipient employing the equivalent of 15 or more employees to complete a written self-evaluation of any age distinction imposed in its program or activity receiving Federal financial assistance from GSA to assess the recipient’s compliance with the Act.

(2) If an assessment indicates a violation of the Act and the GSA regulation, the recipient takes corrective action.

§ 101-8.714 Information requirements.

Each recipient must:

(a) Keep records in a form and containing information that GSA determines necessary to ensure that the recipient is complying with the Act and this regulation.

(b) Provide to GSA upon request, information and reports that GSA determines necessary to find out whether the recipient is complying with the Act and this regulation.

(c) Permit reasonable access by GSA to books, records, accounts, facilities, and other sources of information to the extent GSA finds it necessary to find out whether the recipient is complying with the Act and this regulation. GSA adopts HHS policy regarding the kinds of data and information recipients are expected to keep (45 CFR 90.34). This policy is parallel to compliance information sections in the title VI, title IX, and section 504 implementation regulations. While recognizing the need for enough data to assess recipient compliance, GSA is committed to lessening the data gathering burden on recipients. GSA further recognizes that there is no established body of knowledge or experience to guide the assessment of age discrimination. This regulation, therefore, does not impose specific data requirements upon recipients, rather, it allows GSA to be flexible in deciding what kinds of data should be kept by recipients, based on what kinds of data prove useful as GSA gains experience with the Age Discrimination Act, and age discrimination issues become clearer.

(d) In accordance with the Paperwork Reduction Act of 1980 (Pub. L. 59-511),

§ 101-8.715

the reporting and record keeping provisions included in this regulation will be submitted, for approval, to the Office of Management and Budget (OMB). No data collection or record keeping requirement will be imposed on recipients or donees without the required OMB approval number.

§ 101-8.715 Compliance reviews.

(a) GSA may conduct compliance reviews and use similar procedures to investigate and correct violations of the Act and this regulation. GSA may conduct the reviews even in the absence of a complaint against a recipient. The reviews may be as comprehensive as necessary to determine whether a violation of the Act and this regulation has occurred.

(b) If a compliance review indicates a violation of the Act or this regulation, GSA attempts to achieve voluntary compliance with the Act. If compliance cannot be achieved, GSA arranges for enforcement as described in § 101-8.720.

§ 101-8.716 Complaints.

(a) Any person, individually or as a member of a class (defined at § 101-8.703(e)) or on behalf of others, may file a complaint with GSA alleging discrimination prohibited by the Act or this regulation based on an action occurring after July 1, 1979. A complainant must file a complaint within 80 days from the date the complainant first has knowledge of the alleged act of discrimination. However, for good cause shown, GSA may extend this time limit.

(b) GSA considers the date a complaint is filed to be the date upon which the complaint is sufficient to be processed.

(c) GSA attempts to facilitate the filing of complaints if possible, including taking the following measures:

(1) Accepting as a sufficient complaint, any written statement that identifies the parties involved and the date the complainant first had knowledge of the alleged violation, describes the action or practice complained of, and is signed by the complainant;

(2) Freely permitting a complainant to add information to the complaint to meet the requirements of a sufficient complaint;

41 CFR Ch. 101 (7-1-01 Edition)

(3) Notifying the complainant and the recipient (or their representative) of their right to contact GSA for information and assistance regarding the complaint resolution process.

(d) GSA returns to the complainant any complaint outside the jurisdiction of this regulation, and states the reason(s) why it is outside the jurisdiction of the regulation.

§ 101-8.717 Mediation.

(a) GSA promptly refers to the mediation agency designated by the Secretary, HHS, all sufficient complaints that:

(1) Fall within the jurisdiction of the Act and this regulation, unless the age distinction complained of is clearly within an exception; and

(2) Contain the information needed for further processing.

(b) Both the complainant and the recipient must participate in the mediation process to the extent necessary to reach an agreement or make an informed judgement that an agreement is not possible. Both parties need not meet with the mediator at the same time.

(c) If the complainant and the recipient agree, the mediator will prepare a written statement of the agreement and have the complainant and the recipient sign it. The mediator must send a copy of the agreement to GSA. GSA takes no further action on the complaint unless the complainant or the recipient fails to comply with the agreement.

(d) The mediator must protect the confidentiality of all information obtained in the course of the mediation. No mediator may testify in any adjudicative proceeding, produce any document, or otherwise disclose any information obtained in the course of the mediation process without prior approval of the head of the mediation agency.

(e) The mediation proceeds for a maximum of 60 calendar days after a complaint is filed with GSA. Mediation ends if:

(1) 60 calendar days elapse from the time the complaint is filed; or

(2) Before the end of the 60 calendar-day period an agreement is reached; or

Federal Property Management Regulations

§ 101-8.720

(3) Before the end of that 60 calendar-day period, the mediator finds that an agreement cannot be reached.

NOTE: The 60 calendar day period may be extended by the mediator, with the concurrence of GSA, for not more than 30 calendar days if the mediator determines that agreement is likely to be reached during the extension period.

(f) The mediator must return unresolved complaints to GSA.

§ 101-8.718 Investigation.

(a) *Informal investigation.* GSA investigates complaints that are unresolved after mediation or are reopened because of a violation of a mediation agreement. As part of the initial investigation, GSA uses informal factfinding methods, including joint or separate discussions with the complainant and the recipient, to establish the fact and, if possible, settle the complaint on terms that are mutually agreeable to the parties. GSA may seek the assistance of any involved State program agency. GSA puts any agreement in writing and has it signed by the parties and an authorized official designated by the Administrator or the Director, Office of Organization and Personnel. The settlement may not affect the operation of any other enforcement efforts of GSA, including compliance reviews and investigation of other complaints that may involve the recipient. The settlement is not a finding of discrimination against a recipient.

(b) *Formal investigation.* If GSA cannot resolve the complaint through informal investigation, it begins to develop formal findings through further investigation of the complaint. If the investigation indicates a violation of these regulations, GSA attempts to obtain voluntary compliance. If GSA cannot obtain voluntary compliance, it begins enforcement as described in § 101-8.720.

§ 101-8.719 Prohibition against intimidation or retaliation.

A recipient may not engage in acts of intimidation or retaliation against any person who:

- (a) Attempts to assert a right protected by the Act of this regulation; or
- (b) Cooperates in any mediation, investigation, hearing, conciliation, and enforcement process.

§ 101-8.720 Compliance procedure.

(a) GSA may enforce the Act and these regulations through:

(1) Termination of a recipient's Federal financial assistance from GSA under the program or activity involved where the recipient has violated the Act or this regulation. The determination of the recipient's violation may be made only after a recipient has had an opportunity for a hearing on the record before an administrative law judge.

(2) Any other means authorized by law including, but not limited to:

(i) Referral to the Department of Justice for proceeding to enforce any rights of the United States or obligations of the recipients created by the Act or this regulation, or

(ii) Use of any requirement of or referral to any Federal, State, or local government agency that has the effect of correcting a violation of the Act or this regulation.

(b) GSA limits any termination to the particular recipient and program or activity or part of such program and activity GSA finds in violation of this regulation. GSA does not base any part of a termination on a finding with respect to any program or activity of the recipient that does not receive Federal financial assistance from GSA.

(c) GSA takes no action under paragraph (a) until:

(1) The administrator advises the recipient of its failure to comply with the Act and this regulation and determines that voluntary compliance cannot be obtained, and

(2) 30 calendar days elapse after the Administrator sends a written report of the grounds of the action to the committees of Congress having legislative jurisdiction over the Federal program or activity involved. The Administrator files a report if any action is taken under paragraph (a) of this section .

(d) GSA may also defer granting new Federal financial assistance from GSA to a recipient when a hearing under § 101-8.721 is initiated.

(1) New Federal financial assistance from GSA includes all assistance for which GSA requires an application or

§ 101-8.721

approval, including renewal or continuation of existing activities, or authorization of new activities, during the deferral period. New Federal financial assistance from GSA does not include assistance approved before the beginning of a hearing.

(2) GSA does not begin a deferral until the recipient receives notice of an opportunity for a hearing under § 101-8.721. GSA does not continue a deferral for more than 60 calendar days unless a hearing begins within that time or the time for beginning the hearing is extended by mutual consent of the recipient and the Administrator. GSA does not continue a deferral for more than 30 calendar days after the close of the hearing, unless the hearing results in a finding against the recipient.

(3) GSA limits any deferral to the particular recipient and program or activity or part of such program or activity GSA finds in violation of these regulations. GSA does not base any part of a deferral on a finding with respect to any program or activity of the recipient which does not, and would not, receive Federal financial assistance from GSA.

§ 101-8.721 Hearings.

(a) *Opportunity for hearing.* Whenever an opportunity for a hearing is required, reasonable notice shall be given by registered or certified mail, return receipt requested, to the affected applicant or recipient. This notice shall advise the applicant or recipient of the action proposed to be taken, the specific provision under which the proposed action against it is to be taken, and the matters of fact or law asserted as the basis for this action; and either fix a date not less than 20 days after the date of such notice within which the applicant or recipient may request of the responsible GSA official that the matter be scheduled for hearing or advise the applicant or recipient that the matter in question has been set down for hearing at a stated place and time. The time and place so fixed shall be reasonable and shall be subject to change for cause. The complainant, if any, shall be advised of the time and place of the hearing. An applicant or recipient may waive a hearing and submit written information and argument

41 CFR Ch. 101 (7-1-01 Edition)

for the record. The failure of an applicant or recipient to request a hearing for which a date has been set shall be deemed to be a waiver of the right to a hearing under section 602 of the Act, and consent to the making of a decision on the basis of such information as may be filed as the record.

(b) *Time and place of hearing.* Hearings shall be held at GSA in Washington, D.C., at a time fixed by the Director, Office of Civil Rights (OCR), unless he or she determines that the convenience of the applicant or recipient or of GSA requires that another place be selected. Hearings shall be held before a hearing examiner designated in accordance with 5 U.S.C. 3105 and 3344 (section 11 of the Administrative Procedure Act).

(c) *Right to counsel.* In all proceedings under this section, the applicant or recipient and GSA shall have the right to be represented by counsel.

(d) *Procedures, evidence, and record.* (1) The hearing, decision, and any administrative review thereof shall be conducted in conformity with sections 5-8 of the Administrative Procedure Act, and in accordance with such rules of procedure as are proper (and not inconsistent with this section) relating to the conduct of the hearing, giving of notices subsequent to those provided for in paragraph (a) of this section, taking of testimony, exhibits, arguments and briefs, requests for findings, and other related matters. Both GSA and the applicant or recipient shall be entitled to introduce all relevant evidence on the issues as stated in the notice for hearing or as determined by the Officer conducting the hearing at the outset of or during the hearings. Any person (other than a Government employee considered to be on official business) who, having been invited or requested to appear and testify as a witness on the Government's behalf, attends at a time and place scheduled for a hearing provided for by this part, may be reimbursed for his travel and actual expenses of attendance in an amount not to exceed the amount payable under the standardized travel regulations to a Government employee traveling on official business.

(2) Technical rules of evidence shall not apply to hearings conducted pursuant to this part, but rules or principles designed to assure production of the most credible evidence available and to subject testimony to test by cross-examination shall be applied where reasonably necessary by the officer conducting the hearing. The hearing officer may exclude irrelevant, immaterial, or unduly repetitious evidence. All documents and other evidence offered or taken for the record shall be open to examination by the parties and opportunity shall be given to refute facts and arguments advanced on either side of the issues. A transcript shall be made of the oral evidence except to the extent the substance thereof is stipulated for the record. All decisions shall be based upon the hearing record and written findings shall be made.

(e) *Consolidated or Joint Hearings.* In cases in which the the same or related facts are asserted to constitute non-compliance with this regulation with respect to two or more programs to which this part applies, or noncompliance with this part, and the regulations of one or more other Federal departments or agencies issued under title VI of the Act, the responsible GSA official may, by agreement with such other departments or agencies where applicable, provide for the conduct of consolidated or joint hearings, and for the application to such hearings of rules of procedures not inconsistent with this part. Final decisions in such cases, insofar as this regulation is concerned, shall be made in accordance with § 101-8.722.

§ 101-8.722 Decisions and notices.

(a) *Decisions by hearing examiners.* After a hearing is held by a hearing examiner such hearing examiner shall either make an initial decision, if so authorized, or certify the entire record including his recommended findings and proposed decision to the Agency designated reviewing authority for final decision. A copy of such initial decision or certification shall be mailed to the applicant or recipient and to the complainant, if any. Where the initial decision referred to in this paragraph or in paragraph (c) of this section is made by the hearing exam-

iner, the applicant or recipient or the counsel for GSA may, within the period provided for in the rules of procedure issued by GSA official, file with the reviewing authority exceptions to the initial decision, with his or her reasons therefore. Upon the filing of such exceptions the reviewing authority shall review the initial decision and issue a decision including the reasons therefor. In the absence of exceptions the initial decision shall constitute the final decision, subject to the provisions of paragraph (e) of this section.

(b) *Decisions on record or review by the reviewing authority.* Whenever a record is certified to the reviewing authority for decision or it reviews the decision of a hearing examiner pursuant to paragraph (a) or (c) of this section, the applicant or recipient shall be given reasonable opportunity to file with it briefs or other written statements of its contentions, and a copy of the final decision of the reviewing authority shall be given in writing to the applicant or recipient and to the complainant, if any.

(c) *Decisions on record where a hearing is waived.* Whenever a hearing is waived pursuant to § 101-8.721(a) the reviewing authority shall make its final decision on the record or refer the matter to a hearing examiner for an initial decision to be made on the record. A copy of such decision shall be given in writing to the applicant or recipient, and to the complainant, if any.

(d) *Rulings required.* Each decision of a hearing examiner or reviewing authority shall set forth a ruling on each findings, conclusion, or exception presented, and shall identify the requirement or requirements imposed by or pursuant to this part with which it is found that the applicant or recipient has failed to comply.

(e) *Review in certain cases by the Administrator.* If the Administrator has not personally made the final decision referred to in paragraph (a), (b), or (c) of this section, a recipient or applicant or the counsel for GSA may request the Administrator to review a decision of the Reviewing Authority in accordance with rules of procedure issued by the responsible GSA official. Such review is not a matter of right and shall be granted only where the Administrator

determines there are special and important reasons therefor. The Administrator may grant or deny such request, in whole or in part. He or she may also review such a decision in accordance with rules of procedure issued by the responsible GSA official. In the absence of a review under this paragraph, a final decision referred to in paragraphs (a), (b), (c) of this section shall become the final decision of GSA when the Administrator transmits it as such to Congressional committees with the report required under section 602 of the Act. Failure of an applicant or recipient to file an exception with the Reviewing Authority or to request review under this paragraph shall not be deemed a failure to exhaust administrative remedies for the purpose of obtaining judicial review.

(f) *Content of orders.* The final decision may provide for suspension or termination of, or refusal to grant or continue Federal financial assistance, in whole or in part, to which this regulation applies, and may contain such terms, conditions and other provisions as are consistent with and will effectuate the purposes of the Act and this regulation, including provisions designed to assure that no Federal financial assistance to which this regulation applies will thereafter be extended under such law or laws to the applicant or recipient determined by such decision to be in default in its performance of an assurance given by it pursuant to this regulation, or to have otherwise failed to comply with this regulation unless and until it corrects its non-compliance and satisfies the responsible GSA official that it will fully comply with this regulation.

(g) *Post-termination proceedings.* (1) An applicant or recipient adversely affected by an order issued under paragraph (f) of this section shall be restored to full eligibility to receive Federal financial assistance if it satisfies the terms and conditions of that order for such eligibility or if it brings itself into compliance with this part and provides reasonable assurance that it will fully comply with this part.

(2) Any applicant or recipient adversely affected by an order entered pursuant to paragraph (f) of this section may at any time request the re-

sponsible GSA official to restore fully its eligibility to receive Federal financial assistance. Any such request shall be supported by information showing that the applicant or recipient has met the requirements of paragraph (g)(1) of this section. If the responsible GSA official determines that those requirements have been satisfied, he or she shall restore such eligibility.

(3) If the responsible GSA official denies any such request, the applicant or recipient may submit a request for a hearing in writing, specifying why it believes such official to have been in error. It shall thereupon be given an expeditious hearing, with a decision on the record, in accordance with rules of procedure issued by the responsible GSA official. The applicant or recipient will be restored to such eligibility if it proves at such hearing that it satisfied the requirements of paragraph (g)(1) of this section. While proceedings under this paragraph are pending, the sanctions imposed by the order issued under paragraph (f) of this section shall remain in effect.

§ 101-8.723 Remedial action by recipient.

If GSA finds a recipient discriminated on the basis of age, the recipient must take any remedial action that GSA may require to overcome the effects of the discrimination. If another recipient exercises control over the recipient that discriminated, GSA may require both recipients to take remedial action.

§ 101-8.724 Exhaustion of administrative remedies.

(a) A complainant may file a civil action following the exhaustion of administrative remedies under the Act. Administrative remedies are exhausted if:

(1) 180 calendar days elapse after the complainant files the complaint and GSA makes no finding with regard to the complaint; or

(2) GSA Issues a finding in favor of the recipient.

(b) If GSA fails to make a finding within 180 days or issues a finding in favor of the recipient, GSA must:

(1) Promptly advise the complainant of this fact;

Federal Property Management Regulations

§ 101-9.103

(2) Advise the complainant of his or her right to bring civil action for injunctive relief; and

(3) Inform the complainant:

(i) That the complainant may bring civil action only in a United States district court for the district in which the recipient is located or transacts business;

(ii) That a complainant prevailing in a civil action has the right to be awarded the costs of the action, including reasonable attorney's fees, but that the complainant must demand these costs in the complaint;

(iii) That before commencing the action the complainant must give 30 calendar days notice by registered mail to the Secretary, HHS, The Administrator, the Attorney General of the United States, and the recipient;

(iv) That the notice must state the alleged violation of the Act, the relief requested, the court in which the complainant is bringing the action, and whether or not attorney's fees are demanded in the event the complainant prevails; and

(v) That the complainant may not bring an action if the same alleged violation of the Act by the same recipient is the subject of a pending action in any court of the United States.

§ 101-8.725 Alternate funds disbursal.

If GSA withholds Federal financial assistance from a recipient under this regulation, the Administrator may disburse the assistance to an alternate recipient; any public or nonprofit private organization; or agency or State or political subdivision of the State. The Administrator requires any alternate recipient to demonstrate:

(a) The ability to comply with this regulation; and

(b) The ability to achieve the goals of the Federal Statutes authorizing the program or activity.

PART 101-9—FEDERAL MAIL MANAGEMENT

Sec.

101-9.000 Scope of part.

Subpart 101-9.1—General Provisions

101-9.101 Authority.

101-9.102 Objective.

101-9.103 Definitions.

Subpart 101-9.2—Program Implementation

101-9.201 Agency responsibilities.

101-9.202 Operational cost control functions at the facility level.

Subpart 101-9.3—Reporting Requirements

101-9.301 Agency mail manager information.

101-9.302 Agency mail program data.

Subpart 101-9.4—GSA Responsibilities and Services

Subpart 101-9.49—Illustrations

101-9.4900 Scope of subpart.

101-9.4901 [Reserved]

101-9.4902 Format for mail profile data.

Subpart 101-9.5—U.S. Postal Service Assistance

AUTHORITY: Sec. 2, Pub. L. 94-575, as amended; 44 U.S.C. 2904; sec. 205(c), 63 Stat. 390; 40 U.S.C. 486(c).

SOURCE: 59 FR 62601, Dec. 6, 1994, unless otherwise noted.

§ 101-9.000 Scope of part.

This part sets forth policy for efficient, effective, and economical management by Federal agencies of incoming, internal, and outgoing mail.

Subpart 101-9.1—General Provisions

§ 101-9.101 Authority.

Section 2 of Public Law 94-575, the Federal Records Management Amendments of 1976 (FRMA), as amended, requires the Administrator of General Services to provide guidance and assistance to Federal agencies on records management, which includes the processing of mail by a Federal agency. GSA's responsibility extends to all Federal agencies.

§ 101-9.102 Objective.

The objective of mail management is to ensure rapid handling and accurate delivery of mail throughout the agency at minimum cost consistent with agency mission requirements.

§ 101-9.103 Definitions.

In part 101-9, the following definitions apply:

Addressing standards means the rules and regulations governing the addressing of mail, developed by the U.S. Postal Service, that enhance the processing and delivery of mail, reduce “undeliverable as addressed” mail, and provide cost reduction opportunities.

Class of mail means the classes of mail (First-Class, Second-Class, Third-Class, Fourth-Class, and Express Mail) established by the U.S. Postal Service for U.S. domestic mail.

Courier means a private delivery company or an individual that works for such a company.

Expedited mail is a generic term used to describe mail to be delivered faster than U.S. Postal Service delivery of First, Second, Third, and Fourth-Class mail.

Facility means any location where mail is processed for dispatch.

Facility mail manager means the persons responsible for mail management at a facility.

Federal agency or agency means any executive department as defined in 5 U.S.C. 101, a wholly owned Government corporation as defined in 31 U.S.C. 9101, any independent establishment in the executive branch as defined in 5 U.S.C. 104, any establishment in the legislative or judicial branch of the Government (except the Supreme Court, the Senate, the House of Representatives, and the Architect of the Capitol and any activities under the direction of the Architect of the Capitol).

Incoming mail means mail coming into the agency delivered by an outside source (vendor or agency).

Internal mail means mail that is transmitted within an agency by that agency’s mail center staff, including worldwide distribution, and is not processed for delivery by the U.S. Postal Service or any private company.

Letter means a message directed to a specific person or address and recorded in or on a tangible object. A message consists of any information or intelligence which is recorded on tangible objects such as paper in sheet and card form, or magnetic media.

Mail means letters, hard copies of electronic communications, memoranda, post and postal cards, documents, drawings, microfiche, publications, catalogs and other hard copy

communications, as well as packages meeting U.S. Postal Service size and weight requirements, for distribution or dispatch regardless of the distribution, dispatch, or delivery method including messengers and couriers. An item is considered mailable if it meets the following requirements set by the U.S. Postal Service: a mailable item is an item that will not injure people or property, weighs 70 pounds or less, and is not more than 108 inches (combined length and girth). Mailability requirements, restrictions, and exceptions are found in the U.S. Postal Service’s Domestic Mail Manual (other mail vendors provide similar written guidance for items sent via their delivery services).

Mail center means a centralized location where mail is processed.

Mail piece design means preparation of letters, cards, and flats consistent with U.S. Postal Service requirements and recommendations.

Mail preparation means those processes involved in preparing mail for dispatch in such a way that it meets U.S. Postal Service requirements. These processes include, but are not limited to: sorting, barcoding, banding, air control tagging (ACT), designing mail pieces, and palletizing.

Messenger means an agency employee who delivers agency mail.

Outgoing mail means mail generated from within an agency facility that is addressed for delivery outside that facility; i.e., within or outside the agency, and is processed for delivery by the U.S. Postal Service or a private company.

Service standard means the dependability (consistency of arrival at addressee’s location) and timeliness (meets delivery standard established for the class of service procured) of mail delivery.

Special services means services for fees other than postage; e.g., registered, certified, insured, business reply mail, merchandise return, certificates of mailing, and return receipts.

Worksharing means presorting, barcoding, or otherwise processing outgoing mail in such a way as to qualify for reduced postage rates. Agencies may participate in worksharing through contracts with vendors, when

authorized by that agency to enter into such contracts, or through in-house efforts.

Subpart 101-9.2—Program Implementation

§ 101-9.201 Agency responsibilities.

The head of each agency, or his or her designee, must designate an agency mail manager to be responsible for establishing an agencywide mail management program. The agency mail manager must have visibility within the agency and be at a managerial level enabling him or her to execute an agencywide program. The responsibilities of the agency mail manager include:

(a) Ensuring agencywide awareness and compliance with the mail management standards set forth by the U.S. Postal Service in the Domestic Mail Manual, the International Mail Manual, the Memo to Mailers, and the Postal Bulletin, as well as GSA standards and guidelines.

(b) Negotiating on behalf of the agency with the U.S. Postal Service for mail related services and implementing operational procedures for services acquired from private delivery vendors and couriers.

(c) Developing and distributing throughout the agency an agency mail cost control program. The agency cost control program must include, in addition to written policies regarding actions and procedures necessary to provide timely and cost-effective dispatch and delivery of mail, a plan for transition to automated mailing procedures, including: automated addressing, address list management, and electronic mail. This program must include:

(1) Developing and issuing on an agencywide basis program directives, guidance, and policies for timely and cost-effective mail management. Copies of program directives, policies, and guidance must be available for inspection by GSA. This includes at a minimum:

(i) Instructing mailers to use expedited mail only when required. Mail managers should require that mailers avoid excessive use of expedited mail services. Generally, expedited mail should not be used on Fridays, weekends, or the day before a holiday. When

expedited mail is needed on Fridays, weekends, or the day before a holiday, the mail manager must coordinate with the mailer to ensure delivery to the addressee. For example, if the addressee's building will not be opened consider other delivery arrangements. The mail manager must establish control procedures including written instructions on cost-effective use of expedited mail and must review scheduled expedited mail dispatches to determine if expedited service is necessary. If expedited mail is not necessary, alternatives to be considered include, but are not limited to: First-Class and Priority Mail, from the U.S. Postal Service and package delivery services from other vendors, if the agency has the authority to contract for or enter into agreements with such vendors and in accordance with any existing contracts or agreements for such services to which the agency is a party.

(ii) Maximizing agency cost-effective participation in worksharing programs. This includes proper address list management, compliance with automation addressing standards, presorting, and barcoding.

(2) Monitoring through the agency's local mail managers at all mail facilities, mailings, and other mail management activities using onsite inspections, checklists, or other inspection/review methods.

(3) Developing and directing agency programs and plans for proper use of transportation, equipment, and supply vendors, relative to mail management.

(4) Maintaining records of agencywide volumes (in pieces) and agency postage expenditures (in dollars) by class, weight, special services, and subclass/rate category of mail. One consolidated report on outgoing mail volumes, postage expenditures, and mailable matter dispatched to all carriers must be maintained. (Suggested format appears in § 101-9.4902.)

(5) Establishing procedures for the review and verification of vendor charges including charges contained in the U.S. Postal Service's Official Mail Accounting System billings. U.S. Postal Service charges and other vendor charges must be reviewed and verified at each facility to ensure billing accuracy.

§ 101-9.202

41 CFR Ch. 101 (7-1-01 Edition)

(6) Ensuring that facility mail managers increase their knowledge and skills in mail management on a continuing basis. Training sources include, but are not limited to: U.S. Postal Forums, Postal Customer Council meetings, and training offered by the GSA Interagency Training Center.

§ 101-9.202 Operational cost control functions at the facility level.

The following operations and procedures are applicable to all Federal mail centers, facilities, and offices that generate and process mail. Each facility must designate a mail manager. The facility mail manager is responsible for:

(a) Reviewing, on a continuing basis, facility mail practices and procedures to identify opportunities for improvement and simplification.

(b) Providing centralized control at each facility of all mail processing activities including regularly scheduled and specialized mail messenger services, equipment, and personnel.

(c) Providing training which:

(1) Informs all levels of facility personnel on cost-effective mailing practices for incoming, internal, and outgoing mail.

(2) Includes supplemental guidance and instruction in a format designed for easy reference, revision, and use by persons processing incoming, internal, and outgoing mail or using mail messenger operations. Such information must be distributed to all persons processing mail and users of mail messenger services.

(d) Establishes a policy of and procedures for participation in the Cooperative Administrative Support Unit (CASU) program where applicable and when cost-effective. A CASU can typically provide pickup, sorting, and dispatch of mail through a CASU-managed mail center.

(e) Where authorized, contracting for worksharing programs when mail volumes or lack of resources for proper mail preparation; e.g., presorting and barcoding, make contracting for worksharing the cost-effective choice. Any solicitation for contracting for a mail center must require the contractor to comply with operational

procedures of the agency mail cost control program.

(f) Conducting discussions with local U.S. Postal Service for mail related services and implementing operational procedures for services acquired from mail delivery vendors or couriers.

(g) Processing mail by class with expedited mail, First-Class, and Priority Mail being processed before lower classes of mail.

(h) Attempting to deliver mail to the action office (the office responsible for taking action on the mail once it is received) within 6 hours after it is received by the agency from the carrier. Every attempt should be made to deliver mail to the address or addressee's office; however, incoming bulk business rate mail addressed to an individual may be discarded if the facility cannot readily ascertain the name or whereabouts of the addressee. Incoming First-Class mail that cannot be delivered must be returned to the sender, per the U.S. Postal Service's Domestic Mail Manual.

(i) Reporting unauthorized use of agency postage including penalty or commercial mail stamps, meter impressions, or other postage indicia immediately upon discovery to the agency Inspector General or internal security office, as appropriate.

(j) Reporting mail center deviations from the agency's occupational, safety and health program, in accordance with 29 CFR part 1960 and 29 CFR part 1910.

(k) Establishing and implementing procedures to ensure that mail complies with U.S. Postal Service addressing standards which include automated and electronically generated mailing addresses in order to eliminate as many handwritten addresses as possible. Compliance includes ensuring machine readability, proper formatting, use of directionals (N. Main St., 4th St., NW, etc.), and accurate mail preparation for the various classes and discount rates and/or for the best possible delivery service. The U.S. Postal Service publications (Domestic Mail Manual, International Mail Manual, Memo to Mailers, and the Postal Bulletins) contain all U.S. Postal Service regulations for proper mail preparation and dispatch, and must be utilized

at each location where outgoing mail is processed.

(l) Establishing and reviewing annually in conjunction with the agency security office, a mail security program to ensure appropriate security requirements while not creating undue delay in mail processing. The mail security program must, at a minimum, detail policy and procedures for safe and secure facility operations and for the safe transportation and processing of mail.

(m) Reviewing, prior to the creation of the pieces to be dispatched, all mailings which will (i) consist of 200 or more pieces, or (ii) weigh 50 or more pounds, including mail to be dispatched on behalf of the agency by a third party, for example, the Government Printing Office, to ensure that the agency's needs are met at the lowest possible cost. Mail managers will coordinate with agency printing specialists about the mailing portion of contracted printing jobs prior to entering into a printing agreement.

(n) Establishing and publishing the facility's mail delivery and pickup times, based on need for service, established through the study of mail volumes and service requirements. The facility mail manager's goal is to provide service to the facility at the lowest possible cost. Consistency in mail pickup and delivery can help achieve the goal.

(o) Maintaining close liaison with agency correspondence managers and providing guidance on correspondence management decisions such as the development and design of mailing materials including: Business Reply Mail, letterhead, mailing labels, and envelope design.

(p) Notifying facility personnel that personal incoming, internal, and outgoing mail may not be processed in agency facilities. An exception may be granted at a facility for personnel living on the facility, personnel stationed outside the United States, or other situations where agency/facility personnel would otherwise suffer hardship.

Subpart 101-9.3—Reporting Requirements

§ 101-9.301 Agency mail manager information.

Agencies will provide GSA with the name, title, mailing address, voice and fax telephone number (if applicable) of the designated agency mail manager (see § 101-9.201), and must update the information as necessary. This information will be submitted to GSA as follows: General Services Administration, Attn: Mail Management Branch (FBXM), Room 815, Washington, DC 20406-0001.

§ 101-9.302 Agency mail program data.

(a) Agencies will maintain data, on mail volumes and postage expenditures. This data will conform with the requirements of § 101-9.201(c)(4) of this part. Maintaining this information is critical for agencies to accurately manage their mail programs and to gauge the impacts of rates and classification changes.

(b) Agencies are encouraged to submit narratives, at the end of each fiscal year, on cost savings achieved through more efficient mail management, especially worksharing efforts. The narratives should highlight specific cost savings achieved as a result of mail consolidation, presorting, barcoding, use of a more cost-effective class of mail, etc. In addition, the narrative should specify whether discounts in mail presorting and barcoding are gained through contracts with vendors or through in-house worksharing efforts. Submit narratives to the GSA address in § 101-9.301.

Subpart 101-9.4—GSA Responsibilities and Services

GSA provides agency support in the following areas: arranging for extensions of service from the U.S. Postal Service (i.e., enhancements of services based on specialized requirements as defined by the Domestic Mail Manual); establishing liaisons with U.S. Postal Service at the national level; providing

§ 101-9.4900

support in developing procedures with mail delivery vendors; providing assistance in developing and implementing worksharing programs; providing assistance in developing policy and guidance in mail management and mail operations; providing onsite assistance visits; assisting with mail center layout and design specifications; and providing training in mail program management and effective mail operations.

Subpart 101-9.5—U.S. Postal Service Assistance

The U.S. Postal Service provides agency support in the following areas: supplies required for mail processing such as bags, tags, trays, hampers, priority envelopes, etc.; guidance on mail processing through national account

41 CFR Ch. 101 (7-1-01 Edition)

representatives and other U.S. Postal Service personnel assigned to assist customers; training such as Postal Customer Councils and U.S. Postal Forums; and brochures, booklets, pamphlets, video tapes, posters, and other published materials on mail processing, mail classes, discount procedures, and current rate structure.

Subpart 101-9.49—Illustrations

§ 101-9.4900 Scope of subpart.

This subpart contains illustrations suggested for use in connection with the subject matter covered in Part 101-9.

§ 101.9-4901 [Reserved]

§ 101-9.4902 Format for mail profile data.

	ANNUAL VOLUME (PIECES)	ANNUAL POSTAGE COSTS	CURRENT SAVINGS
FIRST - CLASS MAIL			
LETTER & CARDS			
Barcoded & Presorted			
Presorted			
Other			
Full Rate Postage			
FLATS			
Barcoded			
Presorted			
Other			
Full Rate Postage			
EXPEDITED SERVICE			
USPS Express Mail			
Federal Express			
Other			
2 - DAY SERVICE			
Priority Mail			
Other			
SECOND - CLASS MAIL			
THIRD - CLASS MAIL			
Single Piece			
THIRD CLASS BULK			
Basic Presort			
Barcoded			
Other			
SURFACE PARCELS			
USPS Parcel Post			
Other			
OTHER USPS SERVICES			
Business Reply Mail			
BRMAS			
Merchandise Return			
Numbered Insured			
Registered			
Certified			
INTERNATIONAL MAIL			

§ 101-9.4902 Format for mail profile data

**SUBCHAPTER B [RESERVED]
SUBCHAPTER C—DEFENSE MATERIALS**

**PARTS 101-14—101-15 [RESERVED]
SUBCHAPTER D—PUBLIC BUILDINGS AND SPACE**

PART 101-16 [RESERVED]

**PART 101-17—ASSIGNMENT AND
UTILIZATION OF SPACE**

AUTHORITY: 40 U.S.C. 285, 304c, 601 *et seq.*, 490 note; E.O. 12072, 43 FR 36869, 3 CFR, 1978 Comp., p. 213.

SOURCE: 66 FR 5358, Jan. 18, 2001, unless otherwise noted.

§ 101-17.0 Cross-reference to the Federal Management Regulation (FMR) (41 CFR chapter 102, parts 102-1 through 102-220).

For information on assignment and utilization of space, see FMR part 102-79 (41 CFR part 102-79).

**PART 101-18—ACQUISITION OF
REAL PROPERTY**

Sec.

101-18.000 Scope of part.
101-18.001 Authority.

Subpart 101-18.1—Acquisition by Lease

101-18.100 Basic policy.
101-18.101 Acquisition by GSA.
101-18.102 Acquisition by other agencies.
101-18.103 Agency cooperation.
101-18.104 Delegation of leasing authority.
101-18.104-1 Limitations on the use of delegated authority.
101-18.104-2 Categorical space delegations.
101-18.104-3 Agency special purpose space delegations.
101-18.105 Contingent fees and related procedure.
101-18.106 Application of socioeconomic considerations.

**Subpart 101-18.2—Acquisition by Purchase
or Condemnation**

101-18.200 Purpose.
101-18.201 Basic acquisition policy.
101-18.202 Expenses incidental to transfer.
101-18.203 Litigation expenses.

Subpart 101-18.3 [Reserved]

AUTHORITY: Sec. 1-201(b), E.O. 12072, 43 FR 36869, 3 CFR, 1978 Comp., p. 213.

SOURCE: 39 FR 23202, June 27, 1974, unless otherwise noted.

§ 101-18.000 Scope of part.

(a) This part prescribes policies and procedures governing acquisition of interests in real property.

(b) For more information on the acquisition of real property, see 41 CFR parts 102-71 through 102-82. To the extent that any policy statements in this part are inconsistent with the policy statements in 41 CFR parts 102-71 through 102-82, the policy statements in 41 CFR parts 102-71 through 102-82 are controlling.

[58 FR 40592, July 29, 1993, as amended at 66 FR 5358, Jan. 18, 2001]

§ 101-18.001 Authority.

This part implements applicable provisions of the Federal Property and Administrative Services Act of 1949, as amended, 63 Stat. 377 (40 U.S.C. 471 *et seq.*); the Act of August 27, 1935, as amended, 49 Stat. 886 (40 U.S.C. 304c); the Public Buildings Act of 1959, as amended, Pub. L. 86-249, 73 Stat. 479 (40 U.S.C. 601-615); the Public Buildings Cooperative Use Act of 1976, Pub. L. 94-541, 90 Stat. 2505; the Uniform Relocation Assistance and Real Property Acquisition Policies Act of 1970, Pub. L. 91-646, 84 Stat. 1894; the Federal Urban Land-Use Act, Pub. L. 90-577, 82 Stat. 1104 (40 U.S.C. 531-535); the Rural Development Act of 1972, as amended, Pub. L. 92-419, 86 Stat. 657 (42 U.S.C. 3122); the Fair Housing Act, as amended, Pub. L. 90-284, 82 Stat. 81 (42 U.S.C. 3601 *et seq.*); Reorganization Plan No. 18 of 1950, 15 FR 3177, 64 Stat. 1270 (40 U.S.C. 490 note); Executive Order 12072, 43 FR 36869 (40 U.S.C. 490 note); and OMB Circular A-95 (41 FR 2052).

[58 FR 40592, July 29, 1993]

Subpart 101-18.1 Acquisition by Lease

SOURCE: 58 FR 40592, July 29, 1993, unless otherwise noted.

§ 101-18.100 Basic policy.

(a) GSA will lease privately owned land and building space only when needs cannot be satisfactorily met in Government-controlled space and:

(1) Leasing proves to be more advantageous than the construction of a new or alteration of an existing Federal building;

(2) New construction or alteration is not warranted because requirements in the community are insufficient or indefinite in scope or duration; or

(3) Completion of a new building within a reasonable time cannot be ensured.

(b) Available space in buildings under the custody and control of the United States Postal Service (USPS) will be given priority consideration in fulfilling Federal agency space needs.

(c) Acquisition of space by lease will be on the basis most favorable to the Government, with due consideration to maintenance and operational efficiency, and only at charges consistent with prevailing scales for comparable facilities in the community.

(d) Acquisition of space by lease will be by negotiation except where the sealed bid procedure is required by 41 U.S.C. 253(a). Except as otherwise provided in 41 U.S.C. 253, full and open competition will be obtained among suitable available locations meeting minimum Government requirements.

(e) When acquiring space by lease, the provisions of §101-17.205 regarding determination of the location of Federal facilities shall be strictly adhered to.

(f) When acquiring space by lease, the provisions of section 110(a) of the National Historic Preservation Act of 1966 (16 U.S.C. 470), as amended, regarding the use of historic properties shall be strictly adhered to.

§ 101-18.101 Acquisition by GSA.

(a) GSA will perform all functions of leasing building space, and land incidental thereto, for Federal agencies except as provided in this subpart.

(b) Officials or employees of agencies for which GSA will acquire leased space shall at no time, before or after a space request is submitted to GSA or after a lease agreement is made, directly or indirectly contact lessors, offerors, or potential offerors for the purpose of making oral or written representation or commitments or agreements with respect to the terms of occupancy of particular space, tenant improvements, alterations and repairs, or payment for overtime services, unless authorized by the Director of the Real Estate Division in the responsible GSA regional office or facility support center.

§ 101-18.102 Acquisition by other agencies.

(a) Acquisitions of leased space by agencies possessing independent statutory authority to acquire such space are not subject to GSA approval or authority.

(b) Upon request, GSA will perform, on a reimbursable basis, all functions of leasing building space, and land incidental thereto, for Federal agencies possessing independent leasing authority.

(c) GSA reserves the right to accept or reject reimbursable leasing service requests on a case-by-case basis.

§ 101-18.103 Agency cooperation.

The heads of executive agencies shall:

(a) Cooperate with and assist the Administrator of General Services in carrying out his responsibilities respecting office buildings and space;

(b) Take measures to give GSA early notice of new or changing space requirements;

(c) Seek to economize their requirements for space; and

(d) Continuously review their needs for space in and near the District of Columbia, taking into account the feasibility of decentralizing services or activities which can be carried on elsewhere without excessive costs or significant loss of efficiency.

§ 101-18.104 Delegation of leasing authority.

(a) Agencies are authorized to perform for themselves all functions with

§ 101-18.104

41 CFR Ch. 101 (7-1-01 Edition)

respect to the acquisition of leased space in buildings and land incidental thereto when the following conditions are met:

(1) The space may be leased for no rental, or for a nominal consideration of \$1.00 per annum, and shall be limited to terms not to exceed one (1) year;

(2) Authority has been requested by an executive agency and a specific delegation has been granted by the Administrator of General Services;

(3) A categorical delegation has been granted by the Administrator of General Services for space to accommodate particular types of agency activities, such as military recruiting offices or space for certain county level agricultural activities. A listing of categorical delegations is found at §101-18.104-2; or

(4) The required space is found by the Administrator of General Services to be wholly or predominantly utilized for the special purposes of the agency to occupy such space and is not generally suitable for use by other agencies. Prior approval of GSA shall be obtained before an agency initiates a leasing action involving 2,500 or more square feet of such special purpose space. The request for approval and a Standard Form 81 shall be filed with the GSA regional office having jurisdiction in the area of the proposed leasing action as shown in §101-17.4801. GSA's approval shall be based upon a finding that there is no vacant Government-owned or leased space available that will meet the agency's requirements.

A listing of agency special purpose space delegations is found at §101-18.104-3.

(b) The Departments of Agriculture, Commerce, and Defense may lease their own building space, and land incidental to its use, and provide for its operation, maintenance, and custody when the space is situated outside an urban center. Such leases shall be for terms not to exceed five (5) years. A list of urban centers follows.

LIST OF URBAN CENTERS

Aberdeen, SD:
Brown County.
Abil:
Jones County.
Taylor County.
Akron, OH:

Portage County.
Summit County.
Alaska:
The entire State.
Albany, GA:
Dougherty County.
Albany, IL:
Whiteside County.
Albany, OR:
Linn County.
Albany-Schenectady-Troy, NY:
Albany County.
Rensselaer County.
Saratoga County.
Schenectady County.
Albuquerque, NM:
Bernalillo County.
Alexandria, LA:
Rapides Parish.
Allentown-Bethlehem-Easton, PA-NJ:
Lehigh County, PA.
Northampton County, PA.
Warren, NJ.
Altoona, PA:
Blair County.
Amarillo, TX:
Potter County.
Randall County.
Anaheim-Santa Ana-Garden Grove, CA:
Orange County.
Ann Arbor, MI:
Washtenaw County.
Asheville, NC:
Buncombe County.
Athens, GA:
Clarke County.
Atlanta, GA:
Clayton County.
Cobb County.
De Kalb County.
Fulton County.
Gwinnett County.
Atlantic City, NJ:
Atlantic County.
Augusta, GA-SC:
Richmond County, GA.
Aiken County, SC.
Augusta, ME:
Kennebec County.
Austin, TX:
Travis County.
Bakersfield, CA:
Kern County.
Baltimore, MD:
Baltimore City.
Anne Arundel County.
Baltimore County.
Carroll County.
Howard County.
Baton Rouge, LA:
East Baton Rouge Parish.
Battle Creek, MI:
Calhoun County.
Bay City, MI:
Bay County.
Beaumont-Port Arthur, TX:
Jefferson County.

Federal Property Management Regulations

§ 101-18.104

Orange County.
Billings, MT:
Yellowstone County.
Binghamton, NY-PA:
Broome County, NY.
Tioga County, NY.
Susquehanna County, PA.
Birmingham, AL:
Jefferson County.
Bismarck, ND:
Burleigh County.
Boise, ID:
Ada County.
Boston, MA:
Essex County.
Middlesex County.
Norfolk County.
Plymouth County.
Suffolk County.
Bridgeport, CT:
Fairfield County.
New Haven County.
Brockton, MA:
Bristol County.
Norfolk County.
Plymouth County.
Brownsville-Harlingen-San Benito, TX:
Cameron County.
Buffalo, NY:
Erie County.
Niagara County.
Burlington, VT:
Chittenden County.
Butte, MT:
Silver Bow County.
Calexico-El Centro, CA:
Imperial County.
Canton, OH:
Stark County.
Casper, WY:
Natrona County.
Cedar Rapids, IA:
Linn County.
Champaign-Urbana, IL:
Champaign County.
Charleston, SC:
Berkeley County.
Charleston, County.
Charleston, WV:
Kanawha County.
Charlotte, NC:
Mecklenburg County.
Union County.
Charlottesville, VA:
Charlottesville City.
Albemarle County.
Chattanooga, TN-GA:
Hamilton County, TN.
Walker County, GA.
Cheyenne, WY:
Laramie County.
Chicago, IL:
Cook County.
Du Page County.
Kane County.
Lake County.
McHenry County.
Will County.
Cincinnati, OH-KY-IN:
Clermont County, OH.
Hamilton County, OH.
Warren County, OH.
Boone County, KY.
Campbell County, KY.
Kenton County, KY.
Dearborn County, IN.
Cleveland, OH:
Cuyahoga County.
Geauga County.
Lake County.
Medina County.
Clinton, OK:
Custer County.
Cody, WY:
Park County.
Colorado Springs, CO:
El Paso County.
Columbia, MO:
Boone County.
Columbia, SC:
Lexington County.
Richland County.
Columbus, GA-AL:
Chattahoochee County, GA.
Muscogee County, GA.
Russell County, AL.
Columbus, OH:
Delaware County.
Franklin County.
Pickaway County.
Concord, NH:
Merrimack County.
Corpus Christi, TX:
Nueces County.
Dallas, TX:
Collin County.
Dallas County.
Denton County.
Ellis County.
Davenport-Rock Island-Moline, IA-IL:
Scott County, IA.
Henry County, IL.
Rock Island County, IL.
Dayton, OH:
Greene County.
Miami County.
Montgomery County.
Preble County.
Decatur, IL:
Macon County.
Denver, CO:
Adams County.
Arapahoe County.
Boulder County.
Denver County.
Jefferson County.
Des Moines, IA:
Polk County.
Detroit, MI:
Macomb County.
Oakland County.
Wayne County.
Dubuque, IA:
Dubuque County.

§ 101-18.104**41 CFR Ch. 101 (7-1-01 Edition)**

Duluth-Superior, MN-WI:
St. Louis County, MN.
Douglas County, WI.
Durango, CO:
LaPlata County.
Durham, NC:
Durham County.
Elkins, WV:
Randolph County.
El Paso, TX:
El Paso County.
Erie, PA:
Erie County.
Eugene, OR:
Lane County.
Evansville, IN-KY:
Vanderburgh County, IN.
Warrick County, IN.
Henderson County, KY.
Fall River, MA-RI:
Bristol County, MA.
Newport County, RI.
Fargo-Moorhed, ND-MN:
Cass County, ND.
Clay County, MN.
Fayetteville, NC:
Cumberland County.
Fitchburg-Leominster, MA:
Middlesex County.
Worcester County.
Flint, MI:
Genesee County.
Lapeer County.
Fort Collins, CO:
Larimer County.
Fort Lauderdale-Hollywood, FL:
Broward County.
Fort Smith, AR-OK:
Crawford County, AR.
Sebastian County, AR.
Le Flore County, OK.
Sequoyah County, OK.
Fort Wayne, IN:
Allen County.
Fort Worth, TX:
Johnson County.
Tarrant County.
Frankfort, KY:
Franklin County.
Fresno, CA:
Fresno County.
Gadsden, AL:
Etowah County.
Gainesville, FL:
Alachua County.
Galveston-Texas City, TX:
Galveston County.
Gary-Hammond-East Chicago, IN:
Lake County.
Porter County.
Grand Forks, ND:
Grand Forks County.
Grand Island, NE:
Hall County.
Grand Junction, CO:
Mesa County.
Grand Rapids, MI:
Kent County.
Ottawa County.
Great Falls, MT:
Cascade County.
Greeley, CO:
Weld County.
Green Bay, WI:
Brown County.
Greensboro-High Point, NC:
Guilford County.
Greenville, SC:
Greenville County.
Pickens County.
Greenwood, MS:
Le Flore County.
Hamilton-Middletown, OH:
Butler County.
Harrisburg, PA:
Cumberland County.
Dauphin County.
Perry County.
Hartford, CT:
Hartford County.
Middlesex County.
Tolland County.
Hawaii:
The entire State.
Helena, MT:
Lewis and Clark County.
Hot Springs, AR:
Garland County.
Houston, TX:
Harris County.
Huntington-Ashland, WV-KY-OH:
Cabell County, WV.
Wayne County, WV.
Boyd County, KY.
Lawrence County, OH.
Huntsville, AL:
Limestone County.
Madison County.
Huron, SD:
Beadle County.
Idaho Falls, ID:
Bonneville County.
Indianapolis, IN:
Hamilton County.
Hancock County.
Hendricks County.
Johnson County.
Marion County.
Morgan County.
Shelby County.
Jackson, MI:
Jackson County.
Jackson, MS:
Hinds County.
Rankin County.
Jackson, TN:
Madison County.
Jacksonville, FL:
Duval County.
Jefferson City, MO:
Cole County.
Jersey City, NJ:
Hudson County.
Johnstown, PA:

Federal Property Management Regulations**§ 101-18.104**

Cambria County.
Somerset County.
Kalamazoo, MI:
Kalamazoo County.
Kansas City, MO-KS:
Cass County, MO.
Clay County, MO.
Jackson County, MO.
Platte County, MO.
Johnson County, KS.
Wyandotte County, KS.
Kenosha, WI:
Kenosha County.
Klamath Falls, OR:
Klamath County.
Knoxville, TN:
Anderson County.
Blount County.
Knox County.
Lafayette, LA:
Lafayette Parish.
Lake Charles, LA:
Calcasieu Parish.
Lancaster, PA:
Lancaster County.
Lansing, MI:
Clinton County.
Eaton County.
Ingham County.
Laredo, TX:
Webb County.
Las Vegas, NV:
Clark County.
Lawrence-Haverhill, MA-NH:
Essex County, MA.
Rockingham County, NH.
Lawton, OK:
Comanche County.
Lewiston-Auburn, ME:
Androscoggin County.
Lexington, KY:
Fayette County.
Lima, OH:
Allen County.
Lincoln, NE:
Lancaster County.
Little Rock-North Little Rock, AR:
Pulaski County.
Logan, UT:
Cache County.
Lorain-Elyria, OH:
Lorain County.
Los Angeles-Long Beach, CA:
Los Angeles County.
Louisville, KY/IN:
Jefferson County, KY.
Clark County, IN.
Floyd County, IN.
Lowell, MA:
Middlesex County.
Lubbock, TX:
Lubbock County.
Lynchburg, VA:
Lynchburg City.
Amherst County.
Campbell County.
Macon, GA:
Bibb County.
Houston County.
Madison, WI:
Dane County.
Manchester, NH:
Hillsborough County.
Merrimack County.
Manhattan, KS:
Riley County.
McCook, NE:
Red Willow County.
Medford, OR:
Jackson County.
Memphis, TN-AR:
Shelby County, TN.
Crittenden County, AR.
Meriden, CT:
New Haven County.
Meridian, MS:
Lauderdale County.
Miami, FL:
Dade County.
Midland, TX:
Midland County.
Milwaukee, WI:
Milwaukee County.
Ozaukee County.
Waukesha County.
Minneapolis-St. Paul, MN:
Anoka County.
Dakota County.
Hennepin County.
Ramsey County.
Washington County.
Missoula, MT:
Missoula County.
Mobile, AL:
Baldwin County.
Mobile County.
Monroe, LA:
Ouachita Parish.
Montgomery, AL:
Elmore County.
Montgomery County.
Morgantown, WV:
Monongahela County.
Muncie, IN:
Delaware County.
Muskegon-Muskegon Heights, MI:
Muskegon County.
Muskogee, OK:
Muskogee County.
Nashville, TN:
Davidson County.
Sumner County.
Wilson County.
Newark, NY:
Essex County.
Morris County.
Union County.
New Bedford, MA:
Bristol County.
Plymouth County.
New Britain, CT:
Hartford County.
New Haven, CT:
New Haven County.

§ 101–18.104**41 CFR Ch. 101 (7–1–01 Edition)**

New London-Groton-Norwich, CT:
New London County.

New Orleans, LA:
Jefferson Parish.
Orleans Parish.
St. Bernard Parish.
St. Tammany Parish.

Newport News-Hampton, VA:
Hampton City.
Newport News City.
York County.

New York, NY:
Bronx County.
Kings County.
Nassau County.
New York County.
Queens County.
Richmond County.
Rockland County.
Suffolk County.
Westchester County.

Norfolk-Portsmouth, VA:
Chesapeake City.
Norfolk City.
Portsmouth City.
Virginia Beach City.

Norwalk, CT:
Fairfield County.

Odessa, TX:
Ector County.

Ogden, UT:
Weber County.

Oklahoma City, OK:
Canadian County.
Cleveland County.
Oklahoma County.

Olympia, WA:
Thurston County.

Omaha, NE-IA:
Douglas County, NE.
Sarpy County, NE.
Pottawattamie County, IA.

Orlando, FL:
Orange County.
Seminole County.

Parkersburg, WV:
Wood County.

Paterson-Clifton-Passaic, NJ:
Bergen County.
Passaic County.

Pensacola, FL:
Escambia County.
Santa Rosa County.

Peoria, IL:
Peoria County.
Tazewell County.
Woodford County.

Philadelphia, PA-NJ:
Bucks County, PA.
Chester County, PA.
Delaware County, PA.
Montgomery County, PA.
Philadelphia County, PA.
Burlington County, NJ.
Camden County, NJ.
Gloucester County, NJ.

Phoenix, AZ:
Maricopa County.

Pierre, SD:
Hughes County.

Pittsburgh, PA:
Allegheny County.
Beaver County.
Washington County.
Westmoreland County.

Pittsfield, MA:
Berkshire County.

Portland, ME:
Cumberland County.

Portland, OR-WA:
Clackamas County, OR.
Multnomah County, OR:
Washington County, OR.
Clark County, WA.

Portsmouth, NH:
Rockingham County.

Providence-Pawtucket-Warwick, RI-MA:
Bristol County, RI.
Kent County, RI.
Newport County, RI.
Providence County, RI.
Washington County, RI.
Bristol County, MA.
Norfolk County, MA.
Worcester County, MA.

Provo-Orem, UT:
Utah County.

Pueblo, CO:
Pueblo County.

Puerto Rico:
The entire Commonwealth.

Racine, WI:
Racine County.

Raleigh, NC:
Wake County.

Rapid City, SD:
Pennington County.

Reading, PA:
Berks County.

Reno, NV:
Washoe County.

Richmond, VA:
Richmond City.
Chesterfield County.
Hanover County.
Henrico County.

Roanoke, VA:
Roanoke City.
Roanoke County.

Rochester, NY:
Livingston County.
Monroe County.
Orleans County.
Wayne County.

Rockford, IL:
Boone County.
Winnebago County.

Rolla, MO:
Phelps County.

Rome, GA:
Floyd County.

Sacramento, CA:
Placer County.
Sacramento County.

Federal Property Management Regulations**§ 101-18.104**

Yolo County.
Saginaw, MI:
Saginaw County.
St. Albans, VT:
Franklin County.
St. Joseph, MO:
Buchanan County.
St. Louis, MO-IL:
St. Louis City, MO.
Jefferson County, MO.
St. Charles County, MO.
St. Louis County, MO.
Madison County, IL.
St. Clair County, IL.
Salem, OR:
Marion County.
Polk County.
Salina, KS:
Saline County.
Salisbury, MD:
Wicomico County.
Salt Lake City, UT:
Davis County.
Salt Lake County.
San Angelo, TX:
Tom Green County.
San Antonio, TX:
Bexar County.
Guadalupe County.
San Bernardino-Riverside-Ontario, CA:
Riverside County.
San Bernardino County.
San Diego, CA:
San Diego County.
San Francisco-Oakland, CA:
Alameda County.
Contra Costa County.
Marin County.
San Francisco County.
San Mateo County.
San Jose, CA:
Santa Clara County.
Santa Barbara, CA:
Santa Barbara County.
Santa Fe, NM:
Santa Fe County.
Savannah, GA:
Chatham County.
Scottsbluff, NE:
Scotts Bluff County.
Scranton, PA:
Lackawanna County.
Seattle-Everett, WA:
King County.
Snohomish County.
Sheridan, WY:
Sheridan County.
Shreveport, LA:
Bossier Parish.
Caddo Parish.
Sioux City, IA-NE:
Woodbury County, IA.
Dakota County, NE.
Sioux Falls, SD:
Minnehaha County.
South Bend, IN:
St. Joseph County.
Marshall County.
Spartanburg, SC:
Spartanburg County.
Spokane, WA:
Spokane County.
Springfield-Chicopee-Holyoke, MA:
Hampden County.
Hampshire County.
Worcester County.
Springfield, IL:
Sangamon County.
Springfield, MO:
Greene County.
Springfield, OH:
Clark County.
Stamford, CT:
Fairfield County.
Steubenville-Weirton, OH-WV:
Jefferson County, OH.
Brooke County, WV.
Hancock County, WV.
Stillwater, OK:
Payne County.
Stockton, CA:
San Joaquin County.
Syracuse, NY:
Madison County.
Onondaga County.
Oswego County.
Tacoma, WA:
Pierce County.
Tallahassee, FL:
Leon County.
Tampa-St. Petersburg, FL:
Hillsborough County.
Pinellas County.
Temple, TX:
Bell County.
Terre Haute, IN:
Clay County.
Sullivan County.
Vermillion County.
Vigo County.
Texarkana, TX-AR:
Bowie County, TX.
Miller County, AR.
Toledo, OH-MI:
Lucas County, OH.
Wood County, OH.
Monroe County, MI.
Topeka, KS:
Shawnee County.
Trenton, NJ:
Mercer County.
Tucson, AZ:
Pima County.
Tulsa, OK:
Creek County.
Osage County.
Tulsa County.
Tuscaloosa, AL:
Tuscaloosa County.
Tyler, TX:
Smith County.
Utica-Rome, NY:
Herkimer County.
Oneida County.

§ 101-18.104-1

41 CFR Ch. 101 (7-1-01 Edition)

Vallejo-Napa, CA:
Napa County.
Solano County.
Vicksburg, MS:
Warren County.
Virgin Islands:
The entire Territory.
Waco, TX:
McLennan County.
Walla Walla, WA:
Walla Walla County.
Benton County.
Washington, DC-MD-VA:
District of Columbia.
Montgomery County, MD.
Prince Georges County, MD.
Alexandria City, VA.
Fairfax City, VA.
Falls Church, VA.
Arlington County, VA.
Fairfax County, VA.
Waterbury, CT:
Litchfield County.
New Haven County.
Waterloo, IA:
Black Hawk County.
Wenatchee, WA:
Chelan County.
West Palm Beach, FL:
Palm Beach County.
Wheeling, WV-OH:
Marshall County, WV.
Ohio County, WV.
Belmont County, OH.
Wichita, KS:
Butler County.
Sedgwick County.
Wichita Falls, TX:
Archer County.
Wichita County.
Wilkes Barre-Hazleton, PA:
Luzerne County.
Wilmington, DE-NJ-MD:
New Castle County, DE.
Salem County, NJ.
Cecil County, MD.
Wilmington, NC:
New Hanover County.
Winston-Salem, NC:
Forsyth County.
Worcester, MA:
Worcester County.
Yakima, WA:
Yakima County.
York, PA:
Adams County.
York County.
Youngstown-Warren, OH:
Mahoning County.
Trumbull County.
Yuma, AZ:
Yuma County.

(c) The Administrator of General Services has granted specific delegations of lease acquisition authority which designate urban or major urban

centers different from those listed in paragraph (b) of this section. The list in paragraph (b) does not supersede or alter in any way leasing areas which are attached to such specific delegations. Agencies may continue to exercise the leasing authority granted in specific delegations in the manner and to the extent provided in those delegations.

§ 101-18.104-1 Limitations on the use of delegated authority.

(a) The authority granted in and pursuant to this subpart shall be exercised in accordance with the requirements and limitations of the Federal Property and Administrative Services Act of 1949, as amended; the Budget Enforcement Act of 1990 and OMB Bulletin 91-02, Part B; Federal Property Management Regulations, subchapter D, those authorities listed in §101-18.001; and other applicable laws and regulations, including the General Services Administration Acquisition Regulation (GSAR), the Competition in Contracting Act (CICA), and other OMB requirements.

(b) Pursuant to GSA's long-term authority contained in section 210(h)(1) of the Federal Property and Administrative Services Act of 1949, as amended, (40 U.S.C. 490(h)(1)), agencies delegated the authorities outlined herein may enter into leases for the term specified. In those cases where agency special purposes space delegations include the authority to acquire unimproved land, the land may be leased only on a fiscal year basis.

(c) In accordance with section 7(a) of the Public Buildings Act of 1959, as amended (40 U.S.C. 606), agencies must submit a prospectus to the Administrator of General Services for leases involving a net annual rental in excess of \$1.6 million excluding services and utilities.

NOTE: The thresholds for prospectuses are indexed, and change each year.

(d) Agencies having a need for other than temporary parking accommodations in the urban centers listed in §101-18.102, for Government-owned motor vehicles not regularly house by GSA, shall ascertain the availability of Government-owned or-controlled parking from GSA in accordance with the

Federal Property Management Regulations

§ 101-18.104-3

procedures outlined in §101-17.202-2 prior to instituting procurement action to acquire parking facilities or services.

§ 101-18.104-2 Categorical space delegations.

Subject to the limitations cited in §101-18.104-1, all agencies are authorized to acquire the types of space listed in paragraphs (a) through (p) of this section. Except where otherwise noted, leases may be for terms, including all options, of up to 20 years. The types of space subject to categorical space delegations may be located inside or outside urban centers and are as follows:

(a) Space to house antennas, repeaters, or transmission equipment;

(b) Depots, including, but not limited to, stockpiling depots and torpedo net depots;

(c) Docks, piers, and mooring facilities (including closed storage space required in combination with such facilities);

(d) Fumigation areas;

(e) Garage space (may be leased only on a fiscal year basis);

(f) Greenhouses;

(g) Hangars and other airport operating facilities including, but not limited to, flight preparation space, aircraft storage areas, and repair shops;

(h) Hospitals, including medical clinics;

(i) Housing (temporary), including hotels (does not include quarters obtained pursuant to temporary duty travel or employee relocation);

(j) Laundries;

(k) Quarantine facilities for plants, birds, and other animals;

(l) Ranger stations; i.e., facilities which typically include small offices staffed by one or more uniformed employees, and may include sleeping/family quarters, parking areas, garages, and storage space. Office space within ranger stations is minimal and does not comprise a majority of the space. (May also be referred to as guard stations, information centers, or kiosks.)

(m) Recruiting space for the armed forces (lease terms, including all options, limited to 5 years);

(n) Schools directly related to the special purpose function(s) of an agency;

(o) Specialized storage/depot facilities, such as cold storage; self-storage units; and lumber, oil, gasoline, ship-building materials, and pesticide materials/equipment storage (general purpose warehouse type storage facilities not included);

(p) Space for short-term use as provided in §101-17.203 (lease terms limited to 180 days with extensions granted on a case-by-case basis).

§ 101-18.104-3 Agency special purpose space delegations.

Subject to the limitations cited in §101-18.104-1, the agencies listed below are authorized to acquire the types of space associated with that agency. Except where otherwise noted, agency special purpose space may be leased for terms, including all options, of up to 20 years. Such space may be located either inside or outside urban centers. The agencies and types of space subject to special purpose space delegations are as follows:

(a) Department of Agriculture:

(1) Cotton classing laboratories (lease terms, including all options, limited to 5 years);

(2) Land (if unimproved, may be leased only on a fiscal year basis);

(3) Miscellaneous storage by cubic foot or weight basis;

(4) Office space when required to be located in or adjacent to stockyards, produce markets, produce terminals, airports, and other ports (lease terms, including all options, limited to 5 years);

(5) Space for agricultural commodities stored in licensed warehouses and utilized under warehouse contracts;

(6) Space utilized in cooperation with State and local governments or their instrumentalities (extension services) where the cooperating State or local government occupies a portion of the space and pays a portion of the rent.

(b) Department of Commerce:

(1) Census Bureau—Space required in connection with conducting the decennial census (lease terms, including all options, limited to 5 years);

(2) Laboratories for testing materials, classified or ordnance devices, calibration of instruments, and atmospheric and oceanic research (lease

terms, including all options, limited to 5 years);

(3) Maritime training stations;

(4) Radio stations;

(5) Land (if unimproved, may be leased only on a fiscal year basis);

(6) National Weather Service meteorological facilities.

(c) Department of Defense:

(1) Air Force—Civil Air Patrol Liaison Offices and land incidental thereto when required for use incidental to, in conjunction with, and in close proximity to airports, including aircraft and warning stations (if unimproved, land may be leased only on a fiscal year basis; for space, lease terms, including all options, limited to 5 years);

(2) Armories;

(3) Film library in the vicinity of Washington, DC;

(4) Leased building at Air Force Base, Jackson, MS;

(5) Mess halls;

(6) Ports of embarkation and debarcation;

(7) Post exchanges;

(8) Postal Concentration Center, Long Island City, NY;

(9) Recreation centers;

(10) Reserve training space;

(11) Service clubs;

(12) Testing laboratories (lease terms, including all options, limited to 5 years).

(d) Department of Energy: Facilities housing the special purpose or special location activities of the old Atomic Energy Commission.

(e) Federal Communications Commission: Monitoring station sites.

(f) Department of Health and Human Services: Laboratories (lease terms, including all options, limited to 5 years).

(g) Department of the Interior:

(1) Space in buildings and land incidental thereto used by field crews of the Bureau of Reclamation, Bureau of Land Management, and the Geological Survey in areas where no other Government agencies are quartered (if unimproved, land may be leased only on a fiscal year basis);

(2) National Parks/Monuments Visitors Centers consisting primarily of special purpose space (e.g., visitor reception, information, and rest room facilities) and not general office or administrative space.

(h) Department of Justice:

(1) U.S. marshals Office in any Alaska location (lease terms, including all options, limited to 5 years);

(2) Border Patrol Offices similar in character and utilization to policy stations, involving the handling of prisoners, firearms, and motor vehicles, regardless of location (lease terms, including all options limited to 5 years);

(3) Space used for storage and maintenance of surveillance vehicles and seized property (lease terms, including all options, limited to 5 years);

(4) Space used for review and custody of records and other evidentiary materials (lease terms, including all options, limited to 5 years);

(5) Space used for trail preparation where space is not available in Federal Buildings, Federal Courthouses, USPS facilities, or GSA-leased buildings (lease terms limited to not more than 1 year.)

(i) Office of Thrift Supervision: Space for field offices of Examining Divisions required to be located within Office of Thrift Supervision buildings or immediately adjoining or adjacent to such buildings (lease terms, including all options, limited to 5 years).

(j) Department of Transportation:

(1) Federal Aviation Administration:

(i) Land at airports (if unimproved, land may be leased only on a fiscal year basis);

(ii) Not to exceed 10,000 square feet of space at airports that is used predominantly as general purpose office space in buildings under the jurisdiction of public or private airport authorities (lease terms, including all options, limited to 5 years);

(2) U.S. Coast Guard:

(i) Space for the oceanic unit, Woods Hole, MA;

(ii) Space for port security activities.

(k) Department of the Treasury:

(1) Comptroller of the Currency—Space and land incidental thereto for the use of the Comptroller of the Currency, as well as the operation, maintenance and custody thereof (if unimproved, land may be leased only on a fiscal year basis; for space, lease term, including all options, limited to 5 years);

Federal Property Management Regulations

§ 101-18.201

(2) U.S. Customs Service—Aerostat radar facilities necessary for agency mission activities;

(1) Department of Veterans Affairs:

(1) Guidance and training centers located at schools and colleges;

(2) Space used for veterans hospitals, including outpatient and medical-related clinics, such as drug, mental health, and alcohol.

§ 101-18.105 Contingent fees and related procedure.

The provisions of subpart 3.4 of Title 48 with respect to contingent fees and related procedure are hereby made applicable to all negotiated and sealed bid contracts for the acquisition of real property by lease. The representations and covenants required by that subpart shall be appropriately adapted for use in leases of real property for Government use.

§ 101-18.106 Application of socioeconomic considerations.

(a) In acquiring space by lease, agencies will avoid locations which will work a hardship on employees because (1) there is a lack of adequate low- and moderate-income nondiscriminatory housing for employees within reasonable proximity to the location, and (2) the location is not readily accessible from other areas of the community.

(b) Consideration of low- and moderate-income nondiscriminatory housing for employees and the need for development and redevelopment of areas for socioeconomic improvement will apply to the acquisition of space by lease where:

(1) 100 or more low- or moderate-income employees are expected to be employed in the space to be leased; and

(2) The proposed leasing action involves residential relocation of a majority of the existing low- and moderate-income work force, a significant increase in their transportation or parking costs, travel time that exceeds 45 minutes to the new location, or a 20 percent increase in travel time if travel time to the present facility already exceeds an average of 45 minutes; or

(3) GSA requests Department of Housing and Urban Development (HUD) review in lease actions of special im-

portance not covered by paragraphs (b) (1) and (2) of this section.

(c) HUD, as the agency responsible for providing information concerning the availability of nondiscriminatory low- and moderate-income housing in areas where Federal facilities are to be located, shall be consulted when such information is required.

(d) Other socioeconomic considerations described in §101-19.101 are also applicable to lease acquisitions.

Subpart 101-18.2—Acquisition by Purchase or Condemnation

§ 101-18.200 Purpose.

These regulations will:

(a) Encourage and expedite the acquisition of real property by agreements with owners;

(b) Avoid litigation where possible and relieve congestion in the courts;

(c) Insure consistent treatment of owners in the many Federal programs; and

(d) Promote public confidence in Federal land acquisition practices.

§ 101-18.201 Basic acquisition policy.

GSA, to the greatest extent practicable, will:

(a) Make every reasonable effort to acquire expeditiously real property by negotiation.

(b) Appraise real property before the initiation of negotiations and give the owner or his designated representative an opportunity to accompany the appraiser during his inspection of the property.

(c) Establish, prior to the initiation of negotiations for real property, an amount estimated to be the just compensation therefor and make a prompt offer to acquire the property for the full amount so established. GSA will provide the owner of the real property to be acquired with a written statement of the amount established as just compensation and a summary of the basis for it. Where appropriate, the just compensation for the real property acquired and for damages to remaining real property will be separately stated. The summary statement to be furnished the owner will include the following:

(1) Identification of the real property and the estate or interest therein to be acquired;

(2) Identification of the buildings, structures, and other improvements considered to be part of the real property for which the offer of just compensation is made;

(3) A statement that GSA's determination of just compensation is based on the estimated fair market value of the property to be acquired. If only part of the property is to be acquired or the interest to be acquired is less than the full interest of the owner, the statement will explain the basis for the determination of the just compensation;

(4) A statement that GSA's determination of just compensation is not less than its approved appraisal of the property; and

(5) A statement that any increase or decrease in the fair market value of the real property, prior to the date of valuation, caused by the public improvement or project for which the real property is to be acquired, or by the likelihood that the real property would be acquired for such improvement or project, other than that due to physical deterioration within the reasonable control of the owner, has been disregarded in making the determination of just compensation for the property.

(d) Acquire at least an equal interest in all buildings, structures, or other improvements located upon the real property. This includes buildings, structures, or other improvements that GSA requires to be removed from the real property or that GSA determines will affect adversely the proposed use of the real property. If any buildings, structures, or other improvements comprising part of the real property are the property of an occupant who has the right or obligation to remove them at the expiration of his term, the total just compensation for the real property, including the property of the occupant, will be determined and the occupant will be paid the greater of the:

(1) Fair market value of the buildings, structures, or other improve-

ments to be removed from the property; or

(2) Contributive fair market value of the occupant's improvements to the fair market value of the entirety, which value should not be less than the value of his improvements for removal from the real property. Payment under this paragraph (d) of this section will not be a duplication of any payment otherwise authorized by law. No payment will be made unless the landowner disclaims all interests in the occupant's improvements and the occupant in consideration for such payment shall assign, transfer, and release to the Government all his right, title, and interest in and to such improvements. The occupant may reject payment under this paragraph (d) of this section and obtain payment for his property interests in accordance with other applicable laws.

(e) Obtain only one appraisal on each parcel, tract, etc., of real property to be acquired unless GSA determines that circumstances require an additional appraisal or appraisals.

(f) Maintain records to verify that the landowner or his designated representative(s) was given an opportunity to accompany the appraiser during the inspection of the real property.

(g) Pay an owner or occupant or deposit such payment in the registry of the court before requiring him to surrender his property. To the maximum extent practicable, owners and occupants will be given at least 90 days' notice of displacement before being required to move from real property acquired by GSA. If permitted by GSA to remain in possession for a short period of time after Government acquisition, the rental charged for this occupancy will not be more than the fair rental value of the property to a short-term occupier.

(h) Not intentionally make it necessary for an owner to institute legal proceedings to prove the fact of the taking of his property. Offer to acquire the entire property where the acquisition of a part of a property will leave the owner with an uneconomic remnant.

Federal Property Management Regulations

Pt. 101-19

§ 101-18.202 Expenses incidental to transfer.

GSA will amend its contract-to-sell-real-property forms to provide for reimbursement to vendors in amounts deemed by GSA to be fair and reasonable for the following expenses:

- (a) Recording fees, transfer taxes (other than tax imposed on the United States), and similar expenses incidental to conveying the real property;
- (b) Penalty cost for prepayment of any preexisting recorded mortgage entered into in good faith encumbering said real property; and
- (c) The pro rata portion of real property taxes paid by the vendor for periods subsequent to the day title vests in the United States.

§ 101-18.203 Litigation expenses.

GSA will plan for and take into consideration the possible liability for the payment of litigation expenses of a condemnee as provided for in section 304 of the Act.

Subpart 101-18.3 [Reserved]

PART 101-19—CONSTRUCTION AND ALTERATION OF PUBLIC BUILDINGS

Sec.

- 101-19.000 Scope of part.
- 101-19.001 Authority.
- 101-19.002 Basic policy.
- 101-19.003 Definition of terms.
- 101-19.003-1 Alter.
- 101-19.003-2 Alteration project.
- 101-19.003-3 Construct.
- 101-19.003-4 Executive agency.
- 101-19.003-5 Prospectus.
- 101-19.003-6 Public building.
- 101-19.003-7 United States.

Subpart 101-19.1—General

- 101-19.100 Intergovernmental consultation on Federal projects.
- 101-19.101 Application of socioeconomic considerations.
- 101-19.101-1 Location of buildings.
- 101-19.101-2 Agreement with Secretary of Housing and Urban Development.
- 101-19.101-3 Consultation with HUD.
- 101-19.101-4 Affirmative action plan.
- 101-19.101-5 Agency compliance.

Subpart 101-19.2—Selection and Approval of Projects

- 101-19.201 Determination of need.
- 101-19.202 Priority of projects.
- 101-19.203 Approval of projects.
- 101-19.204 Cooperation and assistance of Federal agencies.

Subpart 101-19.3—Alteration Projects

- 101-19.301 Emergency alteration projects.
- 101-19.302 Prospectuses for reimbursable alteration projects.

Subpart 101-19.4—Construction Projects

- 101-19.401 Contracting for construction.
- 101-19.402 Architectural and engineering services.

Subpart 101-19.5—Delegation of Authority

- 101-19.501 Conditions justifying delegation.
- 101-19.502 Exercise of delegation.

Subpart 101-19.6—Accommodations for the Physically Handicapped

- 101-19.600 Scope of subpart.
- 101-19.601 Authority and applicability.
- 101-19.602 Definitions.
- 101-19.603 Standards.
- 101-19.604 Exceptions.
- 101-19.605 Waiver or modification of standards.
- 101-19.606 Recordkeeping.
- 101-19.607 Reporting.

APPENDIX A TO SUBPART 101-19.6—UNIFORM FEDERAL ACCESSIBILITY STANDARDS

Subparts 101-19.7—101-19.47 [Reserved]

Subpart 101-19.48—Exhibits

- 101-19.4800 Scope of subpart.
- 101-19.4801 Memorandum of understanding between the Department of Housing and Urban Development and the General Services Administration concerning low- and moderate-income housing.

Subpart 101-19.49—Illustration of Forms

- 101-19.4900 Scope of subpart.
- 101-19.4901 [Reserved]
- 101-19.4902 GSA forms.
- 101-19.4902-2974 GSA Form 2974, Status Report for Federally Funded or Leased Buildings—Accommodation of Physically Handicapped.

AUTHORITY: 40 U.S.C. 486(c), 490 and 601-619; 86 Stat. 216.

SOURCE: 39 FR 23214, June 27, 1974, unless otherwise noted.

§ 101-19.000

41 CFR Ch. 101 (7-1-01 Edition)

§ 101-19.000 Scope of part.

(a) This part prescribes policies and procedures for the construction and alteration of public buildings in the United States.

(b) For more information on the construction and alteration of public buildings, see 41 CFR parts 102-71 through 102-82. To the extent that any policy statements in this part are inconsistent with the policy statements in 41 CFR parts 102-71 through 102-82, the policy statements in 41 CFR parts 102-71 through 102-82 are controlling.

[39 FR 23214, June 27, 1974, as amended at 66 FR 5358, Jan. 18, 2001]

§ 101-19.001 Authority.

This part 101-19 implements the applicable provisions of the Federal Property and Administrative Services Act of 1949, 63 Stat. 377, as amended; the Public Buildings Act of 1959 (40 U.S.C. 601-615 as amended); Public Law 90-480, 82 Stat. 718, as amended (42 U.S.C. 4151-4156); the Clean Air Act (42 U.S.C. 1857-1858); the Federal Water Pollution Control Act (33 U.S.C. 1151-1175); the Intergovernmental Cooperation Act of 1968 (42 U.S.C. 4201-4244, 40 U.S.C. 531-535); Evaluation, Review, and Coordination of Federal and Federally Assisted Programs and Projects (Office of Management and Budget Circular A-95 Revised); section 901(b) of the Agriculture Act of 1970, 84 Stat. 1383 as amended by section 601 of the Rural Development Act of 1972, 86 Stat. 674 (42 U.S.C. 1322(b)); Executive Order 12088 (3 CFR 829 (1971-1975 compilation)); Executive Order 11724 (3 CFR 777 (1971-1975 compilation)); Executive Order 12072 of August 16, 1978 (43 FR 36869); the Public Buildings Cooperative Use Act of 1976 (90 Stat. 2507); and title VIII of the Civil Rights Act of 1968 (42 U.S.C. 3601).

[45 FR 37206, June 2, 1980]

§ 101-19.002 Basic policy.

(a) In the process of developing building projects, the policies contained in § 101-17.002 regarding the determination of the location of Federal facilities shall be strictly adhered to.

(b) [Reserved]

(c) To the maximum extent practical, GSA will plan the construction and alteration of Federal facilities when such

action can be shown to be the most prudent and economic means of meeting Federal space requirements.

(d) GSA will provide technical services and guidance to other Federal agencies in the formulation and development of their programs for construction and alteration of special facilities.

(e) Excess properties transferred to GSA will be renovated and altered whenever practical to meet Government space needs.

(f) In selecting sites for public buildings, consideration will also be given to:

(1) Maximum utilization of Government-owned land (including excess land) whenever it is adequate, economically adaptable to requirements and properly located, where such use is consistent with the provisions of Executive Order 11724 of June 25, 1973 (38 FR 16837), and subpart 101-47.8;

(2) A site adjacent to or in the proximity of an existing Federal building which is well located and is to be retained for long-term occupancy; and

(3) Suitable sites in established civic or redevelopment centers which are well planned and properly financed with development initiated and insured.

(g) The design of new buildings and their appurtenances should provide efficient and economical facilities in an architecture of distinction and quality. The architecture should reflect the dignity, enterprise, vigor, and stability of the United States Government. The designs shall embody the finest contemporary American architectural thought and shall respect local architectural characteristics.

(h) In the alteration of existing buildings, GSA will maintain architectural integrity and compatibility with existing structures.

(i) In the design of new public buildings, and to the extent feasible in the alteration of existing public buildings, GSA will (1) insure that such buildings and attendant facilities will be accessible to and usable by the physically handicapped (42 U.S.C. 4151-4156) and (2) utilize, to the maximum extent, modern methods and techniques for the control of air and water pollution

Federal Property Management Regulations

§ 101-19.003-5

(Clean Air Act 42 U.S.C. 1857-1858; Federal Water Pollution Control Act, 33 U.S.C. 1151-1175).

(j) In the siting and locating of buildings on selected sites, GSA representatives will work directly with local officials in seeking to conform as closely as possible to local zoning regulations.

(k) In the design of new public buildings and alterations to public buildings, the objectives of nationally recognized building and performance codes, standards, and specifications will be met and amplified according to the needs of GSA and as necessary to conform with the accident and fire prevention policy objectives stated in §101-20.109-1. In addition, special features of local codes directly related to local circumstances or practices will be, to the maximum extent practical, incorporated into the design.

(l) Parking for Government-owned, visitors', and employees' vehicles will be provided in the planning of public buildings with due regard to the needs of the Federal agencies to be housed in each building, local zoning and parking regulations, availability of public transportation, and availability of planned and existing public and privately owned parking facilities in the locality.

(m) Fine arts, as appropriate, will be incorporated in the design of selected new public buildings. Fine arts, including painting, sculpture, and artistic work in other mediums, will reflect the national cultural heritage and emphasize the work of living American artists.

(n) Security floodlighting, as appropriate, will be incorporated in the design of selected new public buildings. Such security floodlighting will be designed for minimum energy consumption and reflect and enhance the architectural esthetics of the building.

[39 FR 23214, June 27, 1974, as amended at 45 FR 37206, June 2, 1980]

§ 101-19.003 Definition of terms.

For the purposes of this subchapter D the following terms shall have the meanings set forth in this section.

§ 101-19.003-1 Alter.

Alter means repairing, remodeling, improving, extending, or otherwise

changing a public building. The term includes preliminary planning; engineering; architectural, legal, fiscal, and economic investigations and studies; surveys; designs; plans; working drawings; specifications; procedures; and other similar actions necessary for the alteration of a public building.

§ 101-19.003-2 Alteration project.

Alteration project, requiring compliance with section 7 of the Public Buildings Act of 1959, as amended, means a project to alter a public building which is estimated to cost in excess of \$500,000 and which specifies any of the following:

(a) Alterations estimated to be completed in 5 years for the continued use and occupancy of the building.

(b) Alterations to a building and/or its equipment occasioned by a space reassignment.

(c) Alterations occasioned by an emergency.

§ 101-19.003-3 Construct.

Construct means to build a public building. The term includes preliminary planning, engineering, architectural, legal, fiscal, and economic investigations and studies, surveys, designs, plans, working drawings, specifications, procedures, and other similar actions necessary for the construction of a public building.

§ 101-19.003-4 Executive agency.

Executive agency means any executive department or independent establishment in the executive branch of the Government including any wholly owned Government corporation and including the Central Bank for Cooperatives and the regional banks for cooperatives, Federal land banks, Federal intermediate credit banks, Federal home loan banks, Federal Deposit Insurance Corporation, and the Government National Mortgage Association.

§ 101-19.003-5 Prospectus.

Prospectus means the statement of the proposed project, required by section 7 of the Public Buildings Act of 1959, as amended (40 U.S.C. 606), including a description, its location, estimated maximum cost, a comprehensive

§ 101-19.003-6

plan for providing space for all Government officers and employees in the locality of the proposed project, a statement by the Administrator of General Services that suitable space owned by the Government is not available and that suitable rental space is not available at a price commensurate with that to be afforded through the proposed action, and a statement of rents and other housing costs currently being paid by the Government for Federal agencies to be housed in the proposed project.

§ 101-19.003-6 Public building.

(a) *Public building* means any building, whether for single or multi-tenant occupancy, its grounds, approaches, and appurtenances, which is generally suitable for office or storage space or both for the use of one or more Federal agencies or mixed ownership corporations, and shall include: Federal office buildings, post offices, customhouses, courthouses, appraisers stores, border inspection facilities, warehouses, record centers, relocation facilities, similar Federal facilities, and any other buildings or construction projects the inclusion of which the President may deem, from time to time hereafter, to be justified in the public interest; but shall not include any such buildings and construction projects:

(1) On the public domain (including that reserved for national forests and other purposes),

(2) On properties of the United States in foreign countries,

(3) On Indian and native Eskimo properties held in trust by the United States,

(4) On lands used in connection with Federal programs for agricultural, recreational, and conservation purposes, including research in connection therewith,

(5) On or used in connection with river, harbor, flood control reclamation or power projects, or for chemical manufacturing or development projects, or for nuclear production, research, or development projects,

(6) On or used in connection with housing and residential projects,

(7) On military installations (including any fort, camp, post, naval training

41 CFR Ch. 101 (7-1-01 Edition)

station, airfield, proving ground, military supply depot, military school, or any similar facility of the Department of Defense),

(8) On Veterans Administration installations used for hospital or domiciliary purposes, and

(9) The exclusion of which the President may deem, from time to time hereafter, to be justified in the public interest.

(b) Buildings leased by the Government are not "public buildings" within the meaning of the Public Buildings Act of 1959.

§ 101-19.003-7 United States.

United States, when used in a geographical sense, means the 50 States, the District of Columbia, the Commonwealth of Puerto Rico, and the territories and possessions of the United States.

Subpart 101-19.1—General

§ 101-19.100 Intergovernmental consultation on Federal projects.

(a) As used in this section, the following terms will have the meanings defined herein:

(1) *Planning agencies*. Planning agencies are defined as the Governor of a State or, if there is one, the appropriate A-95 clearinghouse of the State, region, or metropolitan area, and the appropriate local, county, metropolitan, regional, and State planning and environmental authorities.

(2) *Federal projects*. Federal projects are defined as public buildings construction projects and lease construction projects required to be authorized in accordance with, or in the manner provided by, the provisions of the Public Buildings Act of 1959, as amended; and projects involving a significant change in the use of federally owned property or property to be acquired by exchange in connection with a public buildings project authorized under the provisions of the Public Buildings Act of 1959, as amended, or the Federal Property and Administrative Services Act of 1949, as amended.

Federal Property Management Regulations

§ 101-19.100

(b) GSA will consult with planning agencies, local elected officials, and appropriate Federal agencies to coordinate Federal projects with development plans and programs of the State, region, and locality in which the project is to be located to ensure that all national, regional, State, and local viewpoints are fully considered and taken into account to the extent possible in planning Federal projects. A written statement containing a clear justification for Federal actions that are inconsistent with local plans will be provided the appropriate planning agencies.

(c) The consultation and coordination pursuant to paragraph (b) of this section will be initiated by the GSA Regional Administrator of the region in which the Federal project is located, and the manner in which the consultation and coordination will be effected is set forth below:

(1) The GSA Regional Administrator will notify the planning agencies at least 30 calendar days before the initiation of any survey conducted for the purpose of preparing a prospectus or Report of Building Project Survey for submittal to the Congress. Notifications of less than 30 calendar days are authorized only in emergency situations. The notification will specify the approximate date(s) on which the survey will be conducted and will request that the GSA Regional Administrator be provided as soon as practicable all pertinent planning and development information that will be considered in connection with the space plan for the community. This information will include city, county, State, and regional plans for land use and development; use of community development funds; neighborhood revitalization; mass transit; highways; flood control; and air, water, solid waste, and other relevant environmental data.

(2) Within 30 calendar days following the approval of a proposed action by the Congress, the GSA Regional Administrator will inform the previously notified planning agencies of the results of the survey. Particular reference will be made to the need, if any, for a new Federal building within a 10-year period or a major lease consolidation which could result in new com-

mercial construction in the community. The letter will request that the GSA Regional Administrator be informed of all changes or refinements in the planning information initially provided, and set forth the following minimum data relative to the proposed Federal project:

- (i) Area or city in which the project will be located;
- (ii) Type of building (office building, post office, courthouse, etc.);
- (iii) Approximate size of building;
- (iv) Specific site location requirements;
- (v) Estimated building population; and
- (vi) Estimated total project cost.

(3) In addition to paragraph (c)(2) of this section, major project designs should be made available to planning agencies at the conceptual design stage, and information received by GSA 2 or more years prior to commencement of action on a project shall be verified.

(4) When GSA is to conduct a site investigation, propose a significant change in the use of federally owned or leased property that may require a complete environmental assessment resulting in a negative declaration or an environmental impact statement, propose the renovation or extension of an existing federally owned building required to be authorized in accordance with the provisions of the Public Buildings Act of 1959, as amended, acquire property by exchange in connection with the construction of a public building, or issue a Solicitation for Offers in connection with a lease construction project as described in paragraph (a)(2) of this section, the GSA Regional Administrator will notify the planning agencies and the principal elected official(s) of the community where the proposed action will take place not less than 30 calendar days in advance of the initiation of such action. Only verbal notification of planning agencies is required if the site investigation is conducted within 1 year of an announcement under paragraph (c)(1) of this section. The organizations and officials so notified will have the 30-day notice period in which to consult with the GSA Regional Administrator and provide him with data and comments pertinent

to the proposed action. Notifications of less than 30 calendar days are authorized only in emergency situations.

(5) When GSA takes action pursuant to §101-47.203-7 of this chapter for the transfer of federally owned real property for a direct project requirement which involves a substantial change in the character of its use, the views of the planning agencies and the principal elected official(s) will be obtained and considered by the GSA Regional Administrator, and these views will be included on GSA Form 1334, Request for Transfer of Excess Real Property and Related Personal Property.

(6) When property is transferred for exchange purposes, the views of the planning agencies and the principal elected official(s) will be considered prior to consummation of the exchange.

(d) The provisions of paragraph (c) of this section shall not be applied when the Administrator of General Services deems that the application thereof would adversely affect the best interest of the Government.

(e) If GSA has determined that any Federal project under its jurisdiction may significantly affect the quality of the human environment, prior to a final decision concerning that project GSA will provide Federal agencies having jurisdiction by law or special expertise with respect to any environmental impact involved, planning agencies which are authorized to develop and enforce environmental standards, and others as appropriate with an adequate opportunity to review such projects pursuant to section 102(2)(C) of the National Environmental Policy Act of 1969 and the regulations of the Council on Environmental Quality (CEQ).

(f) The Federal agencies, planning agencies, and others referred to in paragraph (e) of this §101-19.100 will be notified as follows concerning Federal projects under GSA jurisdiction that are determined to have a significant effect on the human environment:

(1) GSA will transmit copies of the draft environmental statement, prepared in accordance with the provisions of National Environmental Policy Act of 1969, as amended, and the regulations of the Council on Environmental Quality to the Environmental

Protection Agency, and to the Governor of the State, the U.S. Senators of the State, and the U.S. Representative from the congressional district of the State where the project will be located.

(2) Thereafter, GSA will submit copies of the draft environmental statement to the appropriate city mayor and to the Federal, State, and local planning agencies for comment. The allowable period for comment shall be 45 calendar days. If requests for extension are made a maximum period of 15 calendar days may be granted.

(3) Comments received from the Federal agencies, planning agencies, and others will be reconciled through coordination with the Federal and State agencies concerned. The environmental statement may be revised to reflect the additional data and comments obtained. A discussion of problems and objections by Federal agencies and State and local entities in the review process and the recommended disposition of the issues involved will be included in the final text of the environmental statement.

(4) Copies of the final environmental statement will be transmitted to the Environmental Protection Agency and to those persons who submitted substantive comments on the draft statement or requested copies of the final statement. Unless waived by EPA, no irreversible or irretrievable action shall be taken on a project until 30 calendar days after submission of the final statement to EPA.

(g) Through the appropriate planning agencies, Health System Agencies and State Health Planning and Development Agencies authorized to perform comprehensive health planning, pursuant to the National Health Planning and Resources Development Act of 1974, shall be provided adequate opportunity to review Federal projects for construction and/or equipment involving capital expenditures exceeding \$200,000 for modernization, conversion, and expansion of Federal inpatient care facilities that alter the bed capacity or modify the primary function of the facility, as well as plans for provision of major new medical services. Projects to renovate or install mechanical systems, air-conditioning systems, or

Federal Property Management Regulations

§ 101-19.101-3

other similar internal system modifications are excluded. The comments of such agencies or a certification that the agencies were provided a reasonable time to comment and failed to do so shall accompany the plan and budget requests submitted by the Federal agency to the Office of Management and Budget.

(h) Planning agencies should advise GSA of projects which may present potential areas of joint cooperation by contacting the PBS Regional Commissioner for the region in which the project is located.

(Sec. 205(c), 63 Stat. 390; (40 U.S.C. 486(c)))

[39 FR 23214, June 27, 1974, as amended at 42 FR 16779, Mar. 30, 1977; 45 FR 37206, June 2, 1980]

§ 101-19.101 Application of socioeconomic considerations.

This section provides an effective systematic arrangement to insure the availability of low- and moderate-income housing for Federal employees without discrimination because of race, color, religion, or national origin and to influence the improvement in social and economic conditions in the area of Federal buildings.

§ 101-19.101-1 Location of buildings.

(a) GSA, in all its determinations regarding the location of federally constructed buildings and the acquisition of leased buildings, will consider to the maximum possible extent the availability of low- and moderate-income housing for employees without discrimination because of race, color, religion, or national origin and will affirmatively further the purposes of title VIII of the Civil Rights Act of 1968.

(b) Final decisions of the Administrator of General Services will be based on the determination that such decisions will improve the management and administration of governmental activities and services and will foster the programs and policies of the Federal Government.

§ 101-19.101-2 Agreement with Secretary of Housing and Urban Development.

(a) The Administrator of General Services has entered into an agreement

with the Secretary of Housing and Urban Development to utilize the Department of Housing and Urban Development (HUD) to investigate, determine, and report to GSA findings on the availability of low- and moderate-income housing on a nondiscriminatory basis with respect to proposed locations for a federally constructed building or major lease action having a significant socioeconomic impact on a community.

(b) HUD shall advise GSA and other Federal agencies with respect to actions which would increase the availability of low- and moderate-income housing on a nondiscriminatory basis, after a site has been selected for a federally constructed building or a lease executed for space and shall assist in increasing the availability of such housing through its own programs.

(c) The text of the HUD-GSA agreement is located at § 101-19.4801.

§ 101-19.101-3 Consultation with HUD.

(a) In the initial selection of a city or delineation of a general area for location of public buildings or leased buildings, GSA will provide the earliest possible notice to HUD of information with respect to such decisions. Regional offices of HUD, as identified by the Secretary of Housing and Urban Development, and local planning and housing authorities will be consulted concerning the present and planned availability of low- and moderate-income housing on a nondiscriminatory basis in the area where the project is to be located during the project development investigation.

(b) Regional office representatives of HUD, as designated by the Secretary of Housing and Urban Development, will participate in site investigations for the purpose of providing a report to GSA on the availability of low- and moderate-income housing on a nondiscriminatory basis in the area of the investigation.

(c) The HUD Regional Administrator will transmit to the Regional Commissioner, PBS, his evaluation of the sites being considered. In any case in which a proposed site is deemed inadequate on one or more grounds; i.e., supply of low- and moderate-income housing on a

non-discriminatory basis, non-discrimination in the sale and rental of housing on the basis of race, color, religion, or national origin, or availability of transportation from housing to site, the HUD Regional Administrator shall include an outline of corrective actions which, in his judgment, will be required to overcome the inadequacies noted.

(d) The following actions are subject to the provisions of the HUD/GSA Memorandum of Understanding:

(1) All project development investigations.

(2) Site selections for public buildings (or leased space in buildings to be erected by the lessor) in which 100 or more low- and moderate-income employees are expected to be employed in the new building.

(3) GSA requests HUD review in actions of special importance not covered by paragraph (d)(2) of this section.

(e) The Regional Commissioner, PBS, shall promptly notify the HUD Regional Administrator after reaching a decision on the sites to be recommended for a facility and their priority. In the event any of the preferred sites are identified by HUD as inadequate on one or more of the grounds set forth in paragraph (c) of this section, the HUD Regional Administrator shall so advise the Assistant Secretary for Equal Opportunity. The Assistant Secretary will notify the Commissioner, Public Buildings Service, GSA, of HUD's concerns within 5 workdays after notification by the HUD Regional Administrator and agree on the time required to properly present HUD's view.

(f) GSA will provide a written explanation when, after headquarters' review, a location is selected which HUD reported inadequate with respect to one or more of the grounds set forth in paragraph (c) of this section, in accordance with the HUD-GSA Memorandum of Understanding.

§ 101-19.101-4 Affirmative action plan.

(a) Prior to the announcement of a site selected contrary to the recommendation of HUD, the involved Federal agency, GSA, HUD, and the community in which the proposed site is located will utilize the items indi-

cated in the report of the HUD Regional Administrator as a basis for developing a written Affirmative Action Plan. The Affirmative Action Plan will insure that an adequate supply of low- and moderate-income housing will be available on a nondiscriminatory basis, and that there is adequate transportation from housing to the site before the building or space is to be occupied or within a period of 6 months thereafter. Such a plan will also contain appropriate provisions designed affirmatively to further nondiscrimination in the sale and rental of housing on the basis of race, color, religion, or national origin. The Affirmative Action Plan will be prepared in accordance with section 9(g) of the HUD-GSA Memorandum of Understanding, and will include the following points:

(1) The corrective actions specified by HUD under §101-19.101-3(c).

(2) Assurance of the relocating agency that, when the old and new facilities are within the same metropolitan area, transportation will be provided for their low- and moderate-income employees between the old facility or other suitable location and the new facility at the beginning and end of the scheduled workday until sufficient new housing is built accessible to the new facility, as provided in the affirmative action plan.

(3) All agreements which constitute an Affirmative Action Plan will be set forth in writing and will be signed by the appropriate representatives of HUD, GSA, the Federal agency involved, community bodies and agencies, and other interests whose cooperation and/or participation will be necessary to fulfill the requirements of the plan.

(b) The contents of the Affirmative Action Plan will be made public after the site selection decision has been made by GSA.

(c) The HUD Regional Administrator shall be responsible for monitoring compliance with the written Affirmative Action Plan. In the event of non-compliance, HUD and GSA shall undertake appropriate action to secure compliance. The plan should provide for commitments from the community involved to initiate and carry out all feasible efforts to obtain a sufficient

Federal Property Management Regulations

§ 101-19.204

quantity of low- and moderate-income housing available to the agency's personnel on a nondiscriminatory basis with adequate access to the location of the building or space. It should include commitments by the local officials having the authority to remove obstacles to the provisions of such housing when such obstacles exist and to take effective steps to insure its provision. The plan should also set forth the steps proposed by the agency to develop and implement a counseling and referral service to seek out and assist personnel to obtain such housing. As part of any plan, during as well as after its development, HUD will give priority consideration to applications for assistance under its housing programs for the housing proposed to be provided in accordance with the plan.

§ 101-19.101-5 Agency compliance.

(a) Agencies shall cooperate with the Administrator of General Services and provide such information as may be necessary effectively to comply with these regulations and to cooperate with the Secretary of Housing and Urban Development affirmatively to further the purposes of title VIII of the Civil Rights Act of 1968 (42 U.S.C. 3601).

(b) As a minimum, agencies shall determine the number of positions by grade and an estimate of the number of employees whose jobs are being moved. Further details, such as family income and size, minority status, present home location, and status as head-of-household, may also be required depending upon the type, scope, and circumstances of the relocation. GSA will inform agencies concerning specific situations.

(c) Federal agencies who will relocate shall provide counseling and referral service to assist their personnel in obtaining housing. GSA and HUD will cooperate in this effort.

Subpart 101-19.2—Selection and Approval of Projects

§ 101-19.201 Determination of need.

Construction and alteration projects will be selected by the Administrator of General Services based on a continuing investigation and survey of the

public building needs of the Federal Government.

§ 101-19.202 Priority of projects.

Projects shall be equitably distributed throughout the United States with due regard for the comparative urgency of the need for each project as determined by the Administrator of General Services.

§ 101-19.203 Approval of projects.

(a) All public buildings construction and alteration projects involving an expenditure in excess of \$500,000 shall require approval by the Committees on Public Works of the Senate and House of Representatives.

(b) Federal agencies identifying a need for construction or alteration of a public building shall provide the necessary information, including description of the work, location, estimated maximum cost, and justification to the Administrator of General Services.

(c) The Administrator of General Services shall submit prospectuses for approval of public buildings projects to the Committees on Public Works of the Congress.

§ 101-19.204 Cooperation and assistance of Federal agencies.

(a) Federal agencies shall advise and cooperate in the compilation of information supporting a project. Such information shall include:

(1) A statement of net space occupied in public buildings by the Federal agency in the community for which the project is intended, and an itemization of area in square feet allocated to each specific agency function.

(2) A firm statement of entire space and facility requirements.

(3) Detailed information on space requiring special structural or mechanical facilities. Special use facilities for special purpose needs such as built-in and fixed equipment for laboratory, clinical, and other special use purposes must be incorporated into the project prior to submission of the prospectus.

(4) Identification of locations where space should be retained in preference to inclusion in the proposed project.

(b) Space requirements shall be based on currently authorized personnel and

§ 101-19.301

program activities including information on major changes anticipated within the next 5 years.

(c) Requested information shall be submitted within 60 days of the receipt of a request for such information.

(d) Agencies will not be permitted to make changes in approved space layout drawings submitted to GSA for new buildings, following established terminal dates, except where subsequent unusual and compelling agency developments make changes necessary. Requests for such changes will be submitted, over the signature of the head of the department or agency, to the Administrator of General Services for consideration.

Subpart 101-19.3—Alteration Projects

§ 101-19.301 Emergency alteration projects.

Necessary measures to insure the immediate protection of personnel and facilities and for the preservation of life and the avoidance of further property damage may be taken in an emergency prior to the submission of an alteration project prospectus.

§ 101-19.302 Prospectuses for reimbursable alteration projects.

Reimbursable alteration project prospectuses will be prepared on an "as requested" basis. A project which is to be financed in whole or in part from funds appropriated to the requesting agency may be performed without the approval of the Committees on Public Works when the agency appropriation from which payment is to be made is certified by that agency to be available without regard to the provisions of section 7 of the Public Buildings Act of 1959 (40 U.S.C. 606) and the GSA's portion of the estimated cost, if any, does not exceed \$500,000.

Subpart 101-19.4—Construction Projects

§ 101-19.401 Contracting for construction.

Contracting for construction services by GSA will be in accordance with chapter 1 (FPR) and chapter 5B (GSPR) of this title. The method used will be

41 CFR Ch. 101 (7-1-01 Edition)

that most advantageous to the Government.

§ 101-19.402 Architectural and engineering services.

(a) GSA will develop or acquire, by contract, designs and specifications for suitable buildings that will provide space that can be economically utilized and operated, and which are in harmony with surrounding structures in the community.

(b) The contract services of qualified private architects or engineers will be utilized to the fullest extent compatible with the public interest in the performance of architectural or engineering services in connection with the preparation of drawings and specifications for GSA construction projects.

(c) Executive agencies may contract for professional engineering, architectural, and landscape architectural services for projects which fall within the definition of a "public building" contained in section 13 of the Public Buildings Act of 1959 (40 U.S.C. 612) only when the Administrator of General Services has delegated his responsibilities and authorities pursuant to section 15 of that Act (40 U.S.C. 614). (See § 101-19.501 regarding delegations of authority.)

Subpart 101-19.5—Delegation of Authority

§ 101-19.501 Conditions justifying delegation.

The authorities and responsibilities of the Administrator of General Services under the provisions of the Public Buildings Act of 1959, as amended (40 U.S.C. 601-615), shall, except for the authority in section 4 of that Act, upon request, be delegated to the appropriate executive agency where the estimated cost of the project does not exceed \$100,000 and may, in the Administrator's discretion, be delegated in cases exceeding that amount. (See section 15 of the Act.) When the estimated cost of the project exceeds \$100,000, the following criteria will be applied in determining whether a delegation will be made:

Federal Property Management Regulations

§ 101-19.603

(a) The staff capability of the requesting agency to negotiate and administer contracts for the various types of work involved; and

(b) Whether such a delegation will promote efficiency and economy. See §101-19.402(c) regarding contracts for professional engineering and architectural services.

§ 101-19.502 Exercise of delegation.

Delegated work shall be performed according to standards established by the Administrator of General Services. No such delegation of authority shall exempt the person to whom it is made, or the exercise of such authority, from any provision of the Public Buildings Act of 1959, as amended (40 U.S.C. 601-615).

Subpart 101-19.6—Accommodations for the Physically Handicapped

§ 101-19.600 Scope of subpart.

This subpart prescribes standards for the design, construction, lease, and alteration of buildings to ensure, whenever possible, that physically handicapped persons will have ready access to and use of such buildings. Record-keeping and reporting requirements (see §§101-19.606 and 101-19.607) are prescribed for all projects subject to this subpart.

(Sec. 205(c), 63 Stat. 390; 40 U.S.C. 486(c))

[43 FR 16479, Apr. 19, 1978]

§ 101-19.601 Authority and applicability.

This subpart implements Public Law 90-480, approved August 12, 1968, as amended (42 U.S.C. 4151, *et seq.*). The standards prescribed herein shall apply to all Federal agencies and instrumentalities and to non-Federal organizations to the extent provided in the Act.

(Sec. 205(c), 63 Stat. 390; 40 U.S.C. 486(c))

[43 FR 16479, Apr. 19, 1978]

§ 101-19.602 Definitions.

The following definitions shall apply to this subpart 101-19.6:

(a) *Building* means any building or facility (other than a privately owned residential structure not leased by the

Government for subsidized housing programs and any building or facility on a military installation designed and constructed primarily for use by able-bodied military personnel) the intended use for which will require either that the building or facility be accessible to the public or may result in the employment therein of physically handicapped persons, which is to be:

(1) Constructed or altered by, or on behalf of, the United States after September 2, 1969;

(2) Leased in whole or in part by the United States between August 12, 1968, and December 31, 1976, if constructed or altered in accordance with plans and specifications of the United States;

(3) Financed in whole or in part by a grant or a loan made by the United States after August 12, 1968, if the building or facility is subject to standards for design, construction, or alteration issued under authority of the law authorizing such a grant or loan;

(4) Constructed under authority of the National Capital Transportation Act of 1960, the National Capital Transportation Act of 1965, or title III of the Washington Metropolitan Area Transit Regulation Compact; or

(5) Leased in whole or in part by the United States after January 1, 1977, including any renewal, succeeding, or superseding lease.

(b) *Alteration* means repairing, improving, remodeling, extending, or otherwise changing a building.

(c) The terms *bid* and *bidder* shall be construed to include *offer* and *offeror*.

(Sec. 205(c), 63 Stat. 390; 40 U.S.C. 486(c))

[39 FR 23214, June 27, 1974, as amended at 43 FR 16479, Apr. 19, 1978]

§ 101-19.603 Standards.

Except as provided in §101-19.604, every building must be designed, constructed, or altered to meet the minimum requirements of the Uniform Federal Accessibility Standards (uniform standards) developed by the General Services Administration (GSA), the Department of Defense (DOD), the Department of Housing and Urban Development (HUD), and the United States Postal Service (USPS), in consultation with the Department of Health and Human Services. Departing

§ 101-19.604

from these standards by using other methods is permitted if it is clear that equal accessibility and usability of the facility are provided. Except as provided under §§101-19.602 and 101-19.604, buildings designed, constructed, or altered before the effective date of this standard must meet the minimum standards in the GSA Accessibility Standard DG6 from October 14, 1980, to July 31, 1984, or the American Standard Specifications for Making Buildings and Facilities Accessible to and Usable by the Physically Handicapped, published by the American National Standards Institute, Inc. (ANSI A117.1-1961) (R1971) from September 2, 1969, to October 13, 1980. Buildings under design are governed by the criteria of the uniform standards if the date bids were invited falls after the effective date of this rule.

[49 FR 31625, Aug. 7, 1984]

§ 101-19.604 Exceptions.

The standards established in §101-19.603 shall not apply to:

(a) The design, construction, alteration, or lease of any portion of a building which need not, because of its intended use, be made accessible to, or usable by, the public or by physically handicapped persons;

(b) The alteration of an existing building if the alteration does not involve the installation of, or work on, existing stairs, doors, elevators, toilets, entrances, drinking fountains, floors, telephone locations, curbs, parking areas, or any other facilities susceptible of installation or improvements to accommodate the physically handicapped;

(c) The alteration of an existing building, or of portions thereof, to which application of the standards is not structurally possible;

(d) The construction or alteration of a building for which plans and specifications were completed or substantially completed on or before September 2, 1969: *Provided, however,* That any building defined in §101-19.602(a)(4) shall be designed, constructed, or altered in accordance with the standards prescribed in §101-19.603 regardless of design status or bid solicitation as of September 2, 1969; and

41 CFR Ch. 101 (7-1-01 Edition)

(e) The leasing of space when it is found after receiving bids or offers not otherwise legally acceptable that a proposal meets most of the requirements of the Uniform Federal Accessibility Standards. If no offeror or bidder meets all the requirements, then preference must be given to the offeror or bidder who most nearly meets the standards in section 101-19.603. If the award is proposed for a firm other than the one that most nearly meets the Uniform Federal Accessibility Standards and whose bid or offer is reasonable in price and is otherwise legally acceptable, a waiver or modification of the standards must be obtained.

(Sec. 205 (c), 63 Stat. 1390, 40 U.S.C. 486(c))

[39 FR 23214, June 27, 1974, as amended at 43 FR 16479, Apr. 19, 1978; 49 FR 31625, Aug. 7, 1984]

§ 101-19.605 Waiver or modification of standards.

The applicability of the standards set forth in this subpart may be modified or waived on a case-by-case basis upon application to GSA by the head of the department, agency, or instrumentality of the United States concerned only if the Administrator of General Services determines that such waiver or modification is clearly necessary.

§ 101-19.606 Recordkeeping.

The administering agency's file on each contract or grant for the design, construction, lease, or alteration of a building as defined in §101-19.602 shall be documented with a statement either:

(a) That the standards are applicable to and have been or will be incorporated in the design, the construction, or the alteration; (b) that the grant has been or will be made subject to a requirement that the standards will be incorporated in the design, the construction, or the alteration; (c) that the standards have been waived by the Administrator of General Services (in which event the justification for the waiver shall be stated); (d) that the project is within one of the exceptions set out in §101-19.604 (the specific exception shall be identified and justified); or (e) such other statements as

Federal Property Management Regulations

Subpt. 101-19.6, App. A

may be appropriate with respect to application of the standards to the contract or grant. The head of each agency shall be responsible for implementing the file documentation requirement by regulation or other appropriate means. The documentation shall be made available to the Administrator of General Services upon request.

(Sec. 205(c), 63 Stat. 390; 40 U.S.C. 486(c))
[43 FR 16480, Apr. 19, 1978]

§ 101-19.607 Reporting.

(a) Annually each administering agency shall prepare and submit to the Administrator of General Services reports covering all projects subject to the requirements of this subpart 101-19.6 for which funds have been appropriated or for which a contract, grant, or loan has been approved (whichever is applicable) and which are still under design or construction, or buildings for which lease contracts have been awarded. Once a project has been reported as being occupied, it need not be included in subsequent reports. Lease projects

need to be reported only during the period in which the award was made. All reports should be prepared on GSA Form 2974, Status Report for Federally Funded or Leased Buildings—Accommodation of Physically Handicapped. Interagency reports control number 0031-GSA-AN has been assigned to this report.

(b) The annual reporting period, for purposes of this requirement, ends on the last day of August. Reports will be due on the fifteenth calendar day of the following month. The initial report will cover facilities subject to this reporting requirement during the period from September 1, 1981, through August 31, 1982.

(c) Reports will be used for surveys and investigations to ensure compliance with The Architectural Barriers Act, as amended, pursuant to the requirements of the act.

(Sec. 205(c), 63 Stat. 390 (40 U.S.C. 486(c)))
[44 FR 39393, July 6, 1979, as amended at 48 FR 15629, Apr. 12, 1983]

APPENDIX A TO SUBPART 101-19.6—UNIFORM FEDERAL ACCESSIBILITY STANDARDS

TABLE OF CONTENTS	
UNIFORM FEDERAL ACCESSIBILITY STANDARDS	
1. PURPOSE	2
2. GENERAL	2
2.1 Authority	2
2.2 Provisions for Adults	2
3. MISCELLANEOUS INSTRUCTIONS AND DEFINITIONS.	2
3.1 Graphic Conventions	2
3.2 Dimensional Tolerances	2
3.3 Notes	2
3.4 General Terminology	2
3.5 Definitions	3
4. ACCESSIBLE ELEMENTS AND SPACES: SCOPE AND TECHNICAL REQUIREMENTS.	4
4.1 Minimum Requirements	4
4.1.1 Accessible Sites and Exterior Facilities: New Construction	4
4.1.2 Accessible Buildings: New Construction	5
4.1.3 Accessible Housing	7
4.1.4 Occupancy Classifications	7
4.1.5 Accessible Buildings: Additions	11
4.1.6 Accessible Buildings: Alterations	12
4.1.7 Accessible Buildings: Historic Preservation	13
4.2 Space Allowances and Reach Ranges	14
4.3 Accessible Route	15
4.4 Protruding Objects	20
4.5 Ground and Floor Surfaces	22
4.6 Parking and Passenger Loading Zones	23
4.7 Curb Ramps	24
4.8 Ramps	25
4.9 Stairs	27
4.10 Elevators	30
4.11 Platform Lifts	33
4.12 Windows	33
4.13 Doors	33
4.14 Entrances	36
4.15 Drinking Fountains and Water Coolers	36
4.16 Water Closets	37
4.17 Toilet Stalls	38
4.18 Urinals	40
4.19 Lavatories and Mirrors	40
4.20 Bathtubs	40
4.21 Shower Stalls	42
4.22 Toilet Rooms	43
4.23 Bathrooms, Bathing Facilities, and Shower Rooms	44
4.24 Sinks	44
4.25 Storage	44

TABLE OF CONTENTS	
UNIFORM FEDERAL ACCESSIBILITY STANDARDS	
4.26 Handrails, Grab Bars, Tub and Shower Seats	45
4.27 Controls and Operating Mechanisms	45
4.28 Alarms	45
4.29 Tactile Warnings	46
4.30 Signage	47
4.31 Telephones	47
4.32 Seating, Tables, and Work Surfaces	48
4.33 Assembly Areas	49
4.34 Dwelling Units	49
5. RESTAURANTS AND CAFETERIAS.	57
6. HEALTH CARE.	57
7. MERCANTILE.	57
8. LIBRARIES.	58
9. POSTAL FACILITIES.	58
APPENDIX	60
INDEX	70

1. PURPOSE .

This document sets standards for facility accessibility by physically handicapped persons for Federal and federally-funded facilities. These standards are to be applied during the design, construction, and alteration of buildings and facilities to the extent required by the Architectural Barriers Act of 1968, as amended.

The technical provisions of these standards are the same as those of the American National Standard Institute's document A117.1-1980, except as noted in this text and on figures by italics.

2. GENERAL .

2.1 Authority. *These standards were jointly developed by the General Services Administration, the Department of Housing and Urban Development, the Department of Defense, and the United States Postal Service, under the authority of sections 2, 3, 4, and 4a, respectively, of the Architectural Barriers Act of 1968, as amended, Pub. L. No. 90-480, 42 U.S.C. 4151-4157.*

2.2 Provisions For Adults. The specifications in these standards are based upon adult dimensions and anthropometrics.

3. MISCELLANEOUS INSTRUCTIONS AND DEFINITIONS.

3.1 Graphic Conventions. Graphic conventions are shown in Table 1. Dimensions that are not marked "minimum" or "maximum" are absolute, unless otherwise indicated in the text or captions.

3.2 Dimensional Tolerances. All dimensions are subject to conventional building industry tolerances for field conditions.

3.3 Notes. The text of these standards does not contain notes or footnotes. Additional information, explanations, and advisory materials are located in the Appendix. Paragraphs marked with an asterisk have related, nonmandatory material in the Appendix. In the Appendix, the corresponding paragraph numbers are preceded by an A.

3.4 General Terminology.
 comply with. Meet one or more specifications of this standard.
 if, if..then. Denotes a specification that applies only when the conditions described are present.
 may. Denotes an option or alternative.

**Table 1
Graphic Conventions**

Convention	Description
	Typical dimension line showing U.S. customary units (in inches) above the line and SI units (in millimeters) below
	Dimensions for short distances indicated on extended line
	Dimension line showing alternate dimensions required
	Direction of approach
max	Maximum
min	Minimum
	Boundary of clear floor area
	Centerline

3.5 Definitions

shall. Denotes a mandatory specification or requirement.

should. Denotes an advisory specification or recommendation.

3.5 Definitions. The following terms shall, for the purpose of these standards, have the meaning indicated in this section.

Access Aisle. An accessible pedestrian space between elements, such as parking spaces, seating, and desks, that provides clearances appropriate for use of the elements.

Accessible. Describes a site, building, facility, or portion thereof that complies with these standards and that can be approached, entered, and used by physically disabled people.

Accessible Element. An element specified by these standards (for example, telephone, controls, and the like).

Accessible Route. A continuous unobstructed path connecting all accessible elements and spaces in a building or facility. Interior accessible routes may include corridors, floors, ramps, elevators, lifts, and clear floor space at fixtures. Exterior accessible routes may include parking access aisles, curb ramps, walks, ramps, and lifts.

Accessible Space. Space that complies with these standards.

Adaptability. The ability of certain building spaces and elements, such as kitchen counters, sinks, and grab bars, to be added or altered so as to accommodate the needs of either disabled or nondisabled persons, or to accommodate the needs of persons with different types or degrees of disability.

Addition. An expansion, extension, or increase in the gross floor area of a building or facility.

Administrative Authority. A governmental agency that adopts or enforces regulations and standards for the design, construction, or alteration of buildings and facilities.

Alteration. As applied to a building or structure, means a change or rearrangement in the structural parts or elements, or in the means of egress or in moving from one location or position to another. It does not include normal maintenance, repair, reroofing, interior decoration, or changes to mechanical and electrical systems.

Assembly Area. A room or space accommodating fifty or more individuals for religious, recreational, educational, political, social, or amusement purposes, or for the consumption of food and drink, including all connected rooms or spaces with a common means of egress and ingress. Such areas as conference rooms would have to be accessible in accordance with other parts of this standard but would not have to meet all of the criteria associated with assembly areas.

Automatic Door. A door equipped with a power-operated mechanism and controls that open and close the door automatically upon receipt of a momentary actuating signal. The switch that begins the automatic cycle may be a photoelectric device, floor mat, or manual switch mounted on or near the door itself (see power-assisted door).

Circulation Path. An exterior or interior way of passage from one place to another for pedestrians, including, but not limited to, walks, hallways, courtyards, stairways, and stair landings.

Clear. Unobstructed.

Common Use. Refers to those interior and exterior rooms, spaces, or elements that are made available for the use of a restricted group of people (for example, residents of an apartment building, the occupants of an office building, or the guests of such residents or occupants).

Cross Slope. The slope that is perpendicular to the direction of travel (see running slope).

Curb Ramp. A short ramp cutting through a curb or built up to it.

Dwelling Unit. A single unit of residence which provides a kitchen or food preparation area, in addition to rooms and spaces for living, bathing, sleeping, and the like. A single family home is a dwelling unit, and dwelling units are to be found in such housing types as townhouses and apartment buildings.

Egress. Means of. An accessible route of exit that meets all applicable code specifications of the regulatory building agency having jurisdiction over the building or facility.

Element. An architectural or mechanical component of a building, facility, space, or site, e.g., telephone, curb ramp, door, drinking fountain, seating, water closet.

Entrance. Any access point to a building or portion of building or facility used for the purpose of entering. An entrance includes the approach walk, the vertical access leading to the entrance platform, the entrance platform itself, vestibules if provided, the entry door(s) or gate(s), and the hardware of the entry door(s) or gate(s). The principal entrance of a building or facility is the main door through which most people enter.

Essential Features. Those elements and spaces that make a building or facility usable by, or serve the needs of, its occupants or users. Essential features include but are not limited to entrances, toilet rooms, and accessible routes. Essential features do not include those spaces that house the major activities for which the building or facility is intended, such as classrooms and offices.

Extraordinary Repair. The replacement or renewal of any element of an existing building or facility for purposes other than normal maintenance.

3.5 Definitions

<p>Facility. All or any portion of a building, structure, or area, including the site on which such building, structure or area is located, wherein specific services are provided or activities performed.</p> <p>Full and Fair Cash Value. Full and fair cash value is calculated for the estimated date on which work will commence on a project and means:</p> <p>(1) The assessed valuation of a building or facility as recorded in the assessor's office of the municipality and as equalized at one hundred percent (100%) valuation, or</p> <p>(2) The replacement cost, or</p> <p>(3) The fair market value.</p> <p>Functional Spaces. The rooms and spaces in a building or facility that house the major activities for which the building or facility is intended.</p> <p>Housing. A building, facility, or portion thereof, excluding inpatient health care facilities, that contains one or more dwelling units or sleeping accommodations. Housing may include, but is not limited to, one and two-family dwellings, apartments, group homes, hotels, motels, dormitories, and mobile homes.</p> <p>Marked Crossing. A crosswalk or other identified path intended for pedestrian use in crossing a vehicular way.</p> <p>Multifamily Dwelling. Any building containing more than two dwelling units.</p> <p>Operable Part. A part of a piece of equipment or appliance used to insert or withdraw objects, or to activate, deactivate, or adjust the equipment or appliance (for example, coin slot, pushbutton, handle).</p> <p>Physically Handicapped. An individual who has a physical impairment, including impaired sensory, manual, or speaking abilities, which results in a functional limitation in access to and use of a building or facility.</p> <p>Power-assisted Door. A door used for human passage with a mechanism that helps to open the door, or relieve the opening resistance of a door, upon the activation of a switch or a continued force applied to the door itself. If the switch or door is released, such doors immediately begin to close or close completely within 3 to 30 seconds (see automatic door).</p> <p>Public Use. Describes interior or exterior rooms or spaces that are made available to the general public. Public use may be provided at a building or facility that is privately or publicly owned.</p> <p>Ramp. A walking surface in an accessible space that has a running slope greater than 1:20.</p> <p>Running Slope. The slope that is parallel to the direction of travel (see cross slope).</p> <p>Service Entrance. An entrance intended primarily for delivery of services.</p> <p>Signage. Verbal, symbolic, tactile, and pictorial information.</p>	<p>Site. A parcel of land bounded by a property line or a designated portion of a public right-of-way.</p> <p>Site Improvement. Landscaping, paving for pedestrian and vehicular ways, outdoor lighting, recreational facilities, and the like, added to a site.</p> <p>Sleeping Accommodations. Rooms in which people sleep, for example, dormitory and hotel or motel guest rooms.</p> <p>Space. A definable area, e.g., toilet room, hall, assembly area, entrance, storage room, alcove, courtyard, or lobby.</p> <p>Structural Impracticability. Changes having little likelihood of being accomplished without removing or altering a load-bearing structural member and/or incurring an increased cost of 50 percent or more of the value of the element of the building or facility involved.</p> <p>Tactile. Describes an object that can be perceived using the sense of touch.</p> <p>Tactile Warning. A standardized surface texture applied to or built into walking surfaces or other elements to warn visually impaired people of hazards in the path of travel.</p> <p>Temporary. Applies to facilities that are not of permanent construction but are extensively used or essential for public use for a given (short) period of time, for example, temporary classrooms or classroom buildings at schools and colleges, or facilities around a major construction site to make passage accessible, usable, and safe for everybody. Structures directly associated with the actual processes of major construction, such as porta potties, scaffolding, bridging, trailers, and the like, are not included. <i>Temporary as applied to elements means installed for less than 6 months and not required for safety reasons.</i></p> <p>Vehicular Way. A route intended for vehicular traffic, such as a street, driveway, or parking lot.</p> <p>Walk. An exterior pathway with a prepared surface intended for pedestrian use, including general pedestrian areas such as plazas and courts.</p>
--	--

4. ACCESSIBLE ELEMENTS AND SPACES; SCOPE AND TECHNICAL REQUIREMENTS.

4.1 Minimum Requirements.

4.1.1 Accessible Sites and Exterior Facilities: New Construction. An accessible site shall meet the following minimum requirements:

- (1) At least one accessible route complying with 4.3 shall be provided within the boundary of the site from public transportation stops, accessible parking

4.1.2 Accessible Buildings: New Construction

spaces, passenger loading zones if provided, and public streets or sidewalks to an accessible building entrance.

(2) At least one accessible route complying with 4.3 shall connect accessible buildings, facilities, elements, and spaces that are on the same site.

(3) All objects that protrude from surfaces or posts into circulation paths shall comply with 4.4.

(4) Ground surfaces along accessible routes and in accessible spaces shall comply with 4.5.

(5) (a) If parking spaces are provided for employees or visitors, or both, then accessible spaces, complying with 4.6, shall be provided in each such parking area in conformance with the following table:

Total Parking in Lot	Required Minimum Number of Accessible Spaces
1 to 25	1
26 to 50	2
51 to 75	3
76 to 100	4
101 to 150	5
151 to 200	6
201 to 300	7
301 to 400	8
401 to 500	9
501 to 1000	*
1001 and over	**

* 2 percent of total.

** 20 plus 1 for each 100 over 1000.

EXCEPTION: The total number of accessible parking spaces may be distributed among parking lots, if greater accessibility is achieved.

EXCEPTION: This does not apply to parking provided for official government vehicles owned or leased by the government and used exclusively for government purposes.

(b) If passenger loading zones are provided, then at least one passenger loading zone shall comply with 4.6.5.

(c) Parking spaces for side lift vans are accessible parking spaces and may be used to meet the requirements of this paragraph.

(d) Parking spaces at accessible housing complying with 4.6 shall be provided in accordance with the following:

(i) Where parking is provided for all residents, one accessible parking space shall be provided for each accessible dwelling unit; and

(ii) Where parking is provided for only a portion of the residents, an accessible parking space shall be provided on request of the occupant of an accessible dwelling unit;

(iii) Where parking is provided for visitors, 2 percent of the spaces, or at least one, shall be accessible.

(e) Parking spaces at health care facilities complying with 4.6 shall be provided in accordance with the following:

(i) General health care facilities, employee and visitor parking: Comply with Table 4.1.1(5)(a);

(ii) Outpatient facilities: 10 percent of the total number of parking spaces provided;

(iii) Spinal cord injury facilities, employee and visitor parking: 20 percent of total parking spaces provided.

(6) If toilet facilities are provided on a site, then each such public or common use toilet facility shall comply with 4.22. If bathing facilities are provided on a site, then each such public or common use bathing facility shall comply with 4.23.

EXCEPTION: These provisions are not mandatory for single user portable toilet or bathing units clustered at a single location; however, at least one toilet unit complying with 4.22 or one bathing unit complying with 4.23 should be installed at each location whenever standard units are provided.

(7) All signs shall comply with 4.30.1, 4.30.2 and 4.30.3. Elements and spaces of accessible facilities which shall comply with 4.30.5 and shall be identified by the International Symbol of Accessibility are:

- (a) Parking spaces designated as reserved for physically handicapped people;
- (b) passenger loading zones;
- (c) accessible entrances;
- (d) accessible toilet and bathing facilities.

4.1.2 Accessible Buildings: New Construction.

Accessible buildings and facilities shall meet the following minimum requirements:

(1) At least one accessible route complying with 4.3 shall connect accessible building or facility entrances with all accessible spaces and elements within the building or facility.

(2) All objects that overhang circulation paths shall comply with 4.4.

(3) Ground and floor surfaces along accessible routes and in accessible rooms and spaces shall comply with 4.5.

(4) Stairs connecting levels that are not connected by an elevator shall comply with 4.9.

(5) One passenger elevator complying with 4.10 shall serve each level in all multi-story buildings and facilities. If more than one elevator is provided, each elevator shall comply with 4.10.

4.1.2 Accessible Buildings: New Construction

<p><i>EXCEPTION:</i> Elevator pits, elevator penthouses, mechanical rooms, piping or equipment catwalks are excepted from this requirement.</p> <p><i>EXCEPTION:</i> Accessible ramps complying with 4.8 or, if no other alternative is feasible, accessible platform lifts complying with 4.11 may be used in lieu of an elevator.</p> <p>(6) Windows. (Reserved).</p> <p>(7) Doors:</p> <p>(a) At each accessible entrance to a building or facility, at least one door shall comply with 4.13.</p> <p>(b) Within a building or facility, at least one door at each accessible space shall comply with 4.13.</p> <p>(c) Each door that is an element of an accessible route shall comply with 4.13.</p> <p>(d) Each door required by 4.3.10, Egress, shall comply with 4.13.</p> <p><i>EXCEPTION:</i> In multiple-story buildings and facilities where at-grade egress from each floor is impossible, either of the following is permitted: the provision within each story of approved fire and smoke partitions that create horizontal exits, or, the provision within each floor of areas of refuge approved by agencies having authority for safety.</p> <p>(8) At least one principal entrance at each grade floor level to a building or facility shall comply with 4.14, Entrances. When a building or facility has entrances which normally serve any of the following functions: transportation facilities, passenger loading zones, accessible parking facilities, taxi stands, public streets and sidewalks, or accessible interior vertical access, then at least one of the entrances serving each such function shall comply with 4.14, Entrances. Because entrances also serve as emergency exits, whose proximity to all parts of buildings and facilities is essential, it is preferable that all or most exits be accessible.</p> <p>(9) If drinking fountains or water coolers are provided, approximately 50 percent of those provided on each floor shall comply with 4.15 and shall be on an accessible route. If only one drinking fountain or water cooler is provided on any floor, it shall comply with 4.15.</p> <p>(10) If toilet facilities are provided, then each public and common use toilet room shall comply with 4.22. Other toilet rooms shall be adaptable. If bathing facilities are provided, then each public and common use bathroom shall comply with 4.23. Accessible toilet rooms and bathing facilities shall be on an accessible route.</p> <p>(11) If storage facilities such as cabinets, shelves, closets, and drawers are provided in accessible spaces, at least one of each type provided shall contain storage space complying with 4.25. Additional storage may be provided outside of the dimensions shown in Fig. 38.</p>	<p>(12) Controls and operating mechanisms in accessible spaces, along accessible routes, or as parts of accessible elements (for example, light switches and dispenser controls) shall comply with 4.27.</p> <p>(13) If emergency warning systems are provided, then they shall include both audible alarms complying with 4.28.2 and visual alarms complying with 4.28.3. In facilities with sleeping accommodations, the sleeping accommodations shall have an alarm system complying with 4.28.4. Emergency warning systems in health care facilities may be modified to suit standard health care alarm design practice.</p> <p>(14) Tactile warnings shall be provided at hazardous conditions as specified in 4.29.3.</p> <p>(15) If signs are provided, they shall comply with 4.30.1, 4.30.2 and 4.30.3. In addition, permanent signage that identifies rooms and spaces shall also comply with 4.30.4 and 4.30.6.</p> <p><i>EXCEPTION:</i> The provisions of 4.30.4 are not mandatory for temporary information on room and space signage, such as current occupant's name, provided the permanent room or space identification complies with 4.30.4.</p> <p>(16) Public telephones:</p> <p>(a) If public telephones are provided, then accessible public telephones shall comply with 4.31, Telephones, and the following table:</p> <table border="1" style="width: 100%; margin-top: 10px;"> <thead> <tr> <th style="text-align: left;">Number of public telephones provided on each floor:</th> <th style="text-align: left;">Number of telephones required to be accessible.*</th> </tr> </thead> <tbody> <tr> <td>1 or more single unit installations</td> <td>1 per floor</td> </tr> <tr> <td>1 bank**</td> <td>1 per floor</td> </tr> <tr> <td>2 or more banks**</td> <td>1 per bank. Accessible unit may be installed as a single unit in proximity (either visible or with signage) to the bank. At least one public telephone per floor shall meet the requirements for a forward reach telephone.***</td> </tr> </tbody> </table> <p style="font-size: small; margin-top: 10px;">*Additional public telephones may be installed at any height. Unless otherwise specified, accessible telephones may be either forward or side reach telephones.</p> <p style="font-size: small;">**A bank consists of two or more adjacent public telephones, often installed as a unit.</p>	Number of public telephones provided on each floor:	Number of telephones required to be accessible.*	1 or more single unit installations	1 per floor	1 bank**	1 per floor	2 or more banks**	1 per bank. Accessible unit may be installed as a single unit in proximity (either visible or with signage) to the bank. At least one public telephone per floor shall meet the requirements for a forward reach telephone.***
Number of public telephones provided on each floor:	Number of telephones required to be accessible.*								
1 or more single unit installations	1 per floor								
1 bank**	1 per floor								
2 or more banks**	1 per bank. Accessible unit may be installed as a single unit in proximity (either visible or with signage) to the bank. At least one public telephone per floor shall meet the requirements for a forward reach telephone.***								

4.1.4 Occupancy Classifications

<p>***EXCEPTION: For exterior installations only, if dial tone first service is not available, then a side reach telephone may be installed instead of the required forward reach telephone (i.e., one telephone in proximity to each bank shall comply with 4.31).</p> <p>(b) At least one of the public telephones complying with 4.31, Telephones, shall be equipped with a volume control. The installation of additional volume controls is encouraged, and these may be installed on any public telephone provided.</p> <p>(17) If fixed or built-in seating, tables, or work surfaces are provided in accessible spaces, at least 5 percent, but always at least one, of seating spaces, tables, or work surfaces shall comply with 4.32.</p> <p>(18) Assembly areas:</p> <p>(a) If places of assembly are provided, they shall comply with the following table:</p> <table border="1" style="margin-left: 40px;"> <thead> <tr> <th>Capacity of Seating & Assembly Areas</th> <th>Number of Required Wheelchair Locations</th> </tr> </thead> <tbody> <tr><td>50 to 75</td><td>3</td></tr> <tr><td>76 to 100</td><td>4</td></tr> <tr><td>101 to 150</td><td>5</td></tr> <tr><td>151 to 200</td><td>6</td></tr> <tr><td>201 to 300</td><td>7</td></tr> <tr><td>301 to 400</td><td>8</td></tr> <tr><td>401 to 500</td><td>9</td></tr> <tr><td>501 to 1,000</td><td>*</td></tr> <tr><td>over 1,000</td><td>**</td></tr> </tbody> </table> <p>* 2 percent of total ** 20 plus 1 for each 100 over 1,000.</p> <p>(b) Assembly areas with audio-amplification systems shall have a listening system complying with 4.33 to assist a reasonable number of people, but no fewer than two, with severe hearing loss. For assembly areas without amplification systems and for spaces used primarily as meeting and conference rooms, a permanently installed or portable listening system shall be provided. If portable systems are used for conference or meeting rooms, the system may serve more than one room.</p> <p>4.1.3 Accessible Housing. Accessible housing shall comply with the requirements of 4.1 and 4.34 except as noted below:</p> <p>(1) Elevators: Where provided, elevators shall comply with 4.10. Elevators or other accessible means of vertical movement are not required in residential facilities when:</p> <p>(a) No accessible dwelling units are located above or below the accessible grade level; and</p> <p>(b) At least one of each type of common area and amenity provided for use of residents and visitors is available at the accessible grade level.</p>	Capacity of Seating & Assembly Areas	Number of Required Wheelchair Locations	50 to 75	3	76 to 100	4	101 to 150	5	151 to 200	6	201 to 300	7	301 to 400	8	401 to 500	9	501 to 1,000	*	over 1,000	**	<p>(2) Entrances: Entrances complying with 4.14 shall be provided as necessary to achieve access to and egress from buildings and facilities.</p> <p>EXCEPTION: In projects consisting of one-to-four family dwellings where accessible entrances would be extraordinarily costly due to site conditions or local code restrictions, accessible entrances are required only to those buildings containing accessible dwelling units.</p> <p>(3) Common Areas: At least one of each type of common area and amenity in each project shall be accessible and shall be located on an accessible route to any accessible dwelling unit.</p> <p>4.1.4 Occupancy Classifications. Buildings and facilities shall comply with these standards to the extent noted in this section for various occupancy classifications, unless otherwise modified by a special application section. Occupancy classifications, and the facilities covered under each category include, but are not necessarily limited to, the listing which follows:</p> <p>(1) General Exceptions. Accessibility is not required to elevator pits, elevator penthouses, mechanical rooms, piping or equipment catwalks, lookout galleries, electrical and telephone closets, and general utility rooms.</p> <p>(2) Military Exclusions. The following facilities need not be designed to be accessible, but accessibility is recommended since the intended use of the facility may change with time.</p> <p>(a) Unaccompanied personnel housing, closed messes, vehicle and aircraft maintenance facilities, where all work is performed by able-bodied military personnel, and, in general, all facilities which are intended for use or occupancy by able-bodied military personnel only.</p> <p>(b) Those portions of Reserve and National Guard facilities which are designed and constructed primarily for use by able-bodied military personnel. This exclusion does not apply to those portions of a building or facility which may be open to the public or which may be used by the public during the conduct of normal business or which may be used by physically handicapped persons employed or seeking employment at such building or facility. These portions of the building or facility shall be accessible.</p> <p>(c) Where the number of accessible spaces required is determined by the design capacity of a facility (such as parking or assembly areas), the number of able-bodied military persons used in determining the design capacity need not be counted when computing the number of accessible spaces required.</p> <p>(3) Military Housing. In the case of military housing, which is primarily available for able-bodied military personnel and their dependents, at least 5</p>
Capacity of Seating & Assembly Areas	Number of Required Wheelchair Locations																				
50 to 75	3																				
76 to 100	4																				
101 to 150	5																				
151 to 200	6																				
201 to 300	7																				
301 to 400	8																				
401 to 500	9																				
501 to 1,000	*																				
over 1,000	**																				

4.1.4 Occupancy Classifications

percent of the total but at least one unit (on an installation-by-installation basis) of all housing constructed will be designed and built to be either accessible or readily and easily modifiable to be accessible, but in any event, modification of individual units (including the making of adaptations), will be accomplished on a high priority basis when a requirement is identified. Common areas such as walks, streets, parking and play areas, and common entrances to multi-unit facilities shall be designed and built to be accessible.

(4) Assembly. Assembly occupancy includes, among others, the use of a building or structure, or a portion thereof, for the gathering together of persons for purposes such as civic, social or religious functions, recreation, food or drink consumption, or awaiting transportation. A room or space used for assembly purposes by less than fifty (50) persons and accessory to another occupancy shall be included as a part of that major occupancy. For purposes of these standards, assembly occupancies shall include the following:

Facilities	Application
Amusement arcades	All areas for which the intended use will require public access or which may result in employment of physically handicapped persons.
Amusement park structures	
Arenas	
Armories	
Art galleries	
Auditoriums	
Banquet halls	
Bleachers	
Bowling alleys	
Carnivals	
Churches	
Clubs	
Community halls	
Courtrooms (public areas)	
Dance halls	
Drive-in theaters	
Exhibition halls	
Fairs	
Funeral parlors	
Grandstands	
Gymnasiums	
Motion picture theaters	
Indoor & outdoor swimming pools	
Indoor & outdoor tennis courts	
Lecture halls	
Libraries*	
Museums	
Night clubs	
Passenger stations	
Pool & billiard halls	
Restaurants**	
Skating rinks	

Facilities	Application
Stadiums	All areas for which the intended use will require public access or which may result in employment of physically handicapped persons.
Taverns & bars	
Television studios admitting audiences	
Theaters	

*See Part 8 for special applications.
**See Part 5 for special applications.

(5) Business. Business occupancy includes, among others, the use of a building or structure, or a portion thereof, for office, professional or service type transactions, including storage of records and accounts.

Facilities	Application
Animal hospitals, kennels, pounds	All areas for which the intended use will require public access or which may result in employment of physically handicapped persons.
Automobile and other motor vehicle showrooms	
Banks	
Barber shops	
Beauty shops	
Car wash	
Civic administration	
Clinic, outpatient	
Dry cleaning	
Educational above 12th grade	
Electronic data processing	
Fire stations	
Florists & nurseries	
Laboratories: testing & research	
Laundries	
Motor vehicle service stations	
Police stations	
Post offices*	
Print shops	
Professional services: attorney, dentist, physician, engineer, etc.	
Radio & T.V. stations	
Telephone exchanges	

*See Part 9 for special applications.

(6) Educational. Educational occupancy includes, among others, the use of a building or structure, or portion thereof, by six or more persons at any time for educational purposes through the 12th grade. Schools for business or vocational training shall conform to the requirements of the trade, vocation or business taught.

4.1.4 Occupancy Classifications

Facilities	Application	Facilities	Application
Academies Kindergarten Nursery schools Schools	All areas shall comply.	Printing or publishing Recreational vehicles Refuse incineration Shoes Soaps & detergents Steel products: fabrication, assembly Textiles Tobacco Trailers Upholstering Wood, distribution Millwork Woodworking, cabinet Postal mail: processing facilities*	All areas for which the intended use will require public access or which may result in employment of physically handicapped persons.
<p>(7) Factory Industrial. Factory industrial occupancy includes, among others, the use of a building or structure, or portion thereof, for assembling, disassembling, fabricating, finishing, manufacturing, packaging, processing or other operations that are not classified as a Hazardous Occupancy.</p>			
Facilities	Application	Facilities	Application
Aircraft Appliances Athletic equipment Automobile and other motor vehicle Bakeries Beverages Bicycles Boats, building Brick and masonry Broom or brush Business machines Canvas or similar Cameras and photo equipment Carpets & rugs, including cleaning Ceramic products Clothing Construction & agricultural machinery Disinfectants Dry cleaning & dyeing Electronics Engines, including rebuilding Film, photographic Food processing Foundries Furniture Glass products Gypsum Hemp products Ice Jute products Laundries Leather products Machinery Metal Motion pictures & television film Musical instruments Optical goods Paper products Plastic products	All areas for which the intended use will require public access or which may result in employment of physically handicapped persons.	Combustible dust Combustible fibers Combustible liquid Corrosive liquids Explosive material Flammable gas Flammable liquid Liquified petroleum gas Nitromethane Oxidizing materials Organic peroxide	<p>All areas for which the intended use will require public access or which may result in employment of physically handicapped persons.</p> <p>(8) Hazardous. Hazardous occupancy includes, among others, the use of a building or structure, or a portion thereof, that involves the manufacturing, processing, generation or storage of corrosive, highly toxic, highly combustible, flammable or explosive materials that constitute a high fire or explosive hazard, including loose combustible fibers, dust and unstable materials.</p> <p>(9) Institutional. Institutional occupancy includes, among others, the use of a building or structure, or any portion thereof, in which people have physical or medical treatment or care, or in which the liberty of the occupants is restricted. Institutional occupancies shall include the following subgroups:</p> <p>(a) Institutional occupancies for the care of children, including:</p>
Facilities	Application	Facilities	Application
Child care facilities	All public use, common use, or areas which may result in employment of physically handicapped persons.		

4.1.4 Occupancy Classifications

<p>(b) Institutional occupancies used for medical or other treatment or care of persons, some of whom are suffering from physical or mental illness, disease or infirmity, including:</p>		<p>Facilities Department stores Drug stores Markets Retail stores Shopping centers Sales rooms</p>	<p>Application All areas for which the intended use will require public access or which may result in employment of physically handicapped persons.</p>
<p>Facilities Long Term Care Facilities (including Skilled Nursing Facilities, Intermediate Care Facilities, Bed & Care, and Nursing Homes).</p>	<p>Application At least 50 percent of patient toilets and bedrooms; all public use, common use or areas which may result in employment of physically handicapped persons.</p>	<p>* See Part 7 for special applications.</p>	
<p>Outpatient Facilities:</p>	<p>All patient toilets and bedrooms, all public use, common use, or areas which may result in employment of physically handicapped persons.</p>	<p>(11) Residential. Residential occupancy includes, among others, the use of a building or structure, or portion thereof, for sleeping accommodations when not classed as an institutional occupancy. Residential occupancies shall comply with the requirements of 4.1 and 4.34 except as follows:</p> <p>(a) Residential occupancies where the occupants are primarily transient in nature (less than 30 days) including:</p>	
<p>Hospital*:</p>		<p>Facilities Hotels Motels Boarding houses</p>	<p>Application 5 percent of the total units, or at least one, whichever is greater, and all public use, common use, and areas which may result in employment of physically handicapped persons.</p>
<p>General Purpose Hospital:</p>	<p>At least 10 percent of patient toilets and bedrooms, all public use, common use, or areas which may result in employment of physically handicapped persons.</p>	<p>(b) Residential occupancies in multiple dwellings where the occupants are primarily permanent in nature, including:</p>	
<p>Special Purpose Hospital: (Hospitals that affect mobility).</p>	<p>All patient toilets and bedrooms, all public use, common use, or areas which may result in employment of physically handicapped persons.</p>	<p>Facilities Multifamily housing (Apartment houses):</p>	<p>Application</p>
<p>* See Part 6 for special applications.</p>		<p>Federally assisted</p>	<p>5 percent of the total, or at least one unit, whichever is greater, in projects of 15 or more dwelling units, or as determined by the appropriate Federal agency following a local needs assessment conducted by local government bodies or states under applicable regulations.</p>
<p>(c) Institutional occupancies where the occupants are under some degree of restraint or restriction for security reasons including:</p>		<p>Federally owned</p>	<p>5 percent of the total, or at least one unit, whichever is greater.</p>
<p>Facilities Jails Prisons Reformatories Other detention or correctional facilities</p>	<p>Application 5 percent of residential units available, or at least one unit, whichever is greater; all common use, visitor use, or areas which may result in employment of physically handicapped persons.</p>	<p>Dormitories</p>	<p>5 percent of the total, or at least one unit, whichever is greater.</p>
<p>(10) Mercantile*. Mercantile occupancy includes, among others, all buildings and structures or parts thereof, for the display and sale of merchandise, and involving stocks of goods, wares or merchandise incidental to such purposes and accessible to the public.</p>			

4.1.5 Accessible Buildings: Additions

<p>(c) Residential occupancies in one (1) and two (2) family dwellings where the occupancies are primarily permanent in nature and not classified as preceding residential categories or as institutional.</p>		<p>Facilities</p> <p>Cement in bags Electrical insulators Gypsum board Inert pigments Dry insecticides</p>	<p>Application</p> <p>All areas for which the intended use will require public access or which may result in employment of physically handicapped persons shall comply.</p>
<p>Facilities</p> <p>One and two family dwelling:</p>	<p>Application</p>	<p>(13) Utility and Miscellaneous. Utility and miscellaneous occupancies include, among others, accessory buildings and structures, such as:</p>	
<p>Federally assisted rental</p>	<p>5 percent of the total, or at least one unit, whichever is greater, in projects of 15 or more dwelling units, or as determined by the appropriate Federal agency following a local needs assessment conducted by local government bodies or states under applicable regulations.</p>	<p>Facilities</p> <p>Fences over 6 ft. high Tanks Cooling towers Retaining walls Buildings of less than 1,000 sq. ft. such as: Private garages Carports Sheds Agricultural buildings</p>	<p>Application</p> <p>All areas for which the intended use will require public access or which may result in employment of physically handicapped persons shall comply.</p>
<p>Federally assisted homeownership</p>	<p>To be determined by home buyer.</p>	<p>4.1.5 Accessible Buildings: Additions. Each addition to an existing building shall comply with 4.1.1 to 4.1.4 of 4.1, Minimum Requirements, except as follows:</p>	
<p>Federally owned</p>	<p>5 percent of the total, or at least one unit, whichever is greater.</p>	<p>(1) Entrances. If a new addition to a building or facility does not have an entrance, then at least one entrance in the existing building or facility shall comply with 4.1.4, Entrances.</p>	
<p>(12) Storage. Storage occupancy includes, among others, the use of a building or structure, or portion thereof, for storage that is not classified as a Hazardous Occupancy.</p>	<p>Facilities</p> <p>Metal desks Electrical coils Electrical motors Dry cell batteries Metal parts Empty cans Stoves Washers & Dryers Metal cabinets Glass bottles with noncombustible liquid Mirrors Foods in non-combustible containers Frozen foods Meats Fresh fruits and vegetables Dairy products Beer or wine up to 12 percent alcohol Distribution transformers</p>	<p>Application</p> <p>All areas for which the intended use will require public access or which may result in employment of physically handicapped persons shall comply.</p>	<p>(2) Accessible route. If the only accessible entrance to the addition is located in the existing building or facility, then at least one accessible route shall comply with 4.3, Accessible Route, and shall provide access through the existing building or facility to all rooms, elements, and spaces in the new addition.</p>
		<p>(3) Toilet and bathing facilities. If there are no toilet rooms and bathing facilities in the addition and these facilities are provided in the existing building, then at least one toilet and bathing facility in the existing building shall comply with 4.2.2, Toilet Rooms, or 4.2.3, Bathrooms, Bathing Facilities, and Shower Rooms.</p>	
		<p>(4) Elements, spaces, and common areas. If elements, spaces, or common areas are located in the existing building and they are not provided in the addition, then consideration should be given to making those elements, spaces, and common areas accessible in the existing building.</p>	

4.1.5 Accessible Buildings: Additions

EXCEPTIONS: Mechanical rooms, storage areas, and other such minor additions which normally are not frequented by the public or employees of the facility are excepted from 4.1.5.

(5) **Housing:** (Reserved).

4.1.6 Accessible Buildings: Alterations.

(1) **General.** Alterations to existing buildings or facilities shall comply with the following:

(a) If existing elements, spaces, essential features, or common areas are altered, then each such altered element, space, feature, or area shall comply with the applicable provisions of 4.1.1 to 4.1.4 of 4.1, *Minimum Requirements*.

(b) If power-driven vertical access equipment (e.g., escalator) is planned or installed where none existed previously, or if new stairs (other than stairs installed to meet emergency exit requirements) requiring major structural changes are planned or installed where none existed previously, then a means of accessible vertical access shall be provided that complies with 4.7, *Curb Ramps*; 4.8, *Ramps*; 4.10, *Elevators*; or 4.11, *Platform Lifts*; except to the extent where it is structurally impracticable in transit facilities.

(c) If alterations of single elements, when considered together, amount to an alteration of a space of a building or facility, the entire space shall be made accessible.

(d) No alteration of an existing element, space, or area of a building shall impose a requirement for greater accessibility than that which would be required for new construction. For example, if the elevators and stairs in a building are being altered and the elevators are, in turn, being made accessible, then no accessibility modifications are required to the stairs connecting levels connected by the elevator.

(e) If the alteration work is limited solely to the electrical, mechanical, or plumbing system and does not involve the alteration of any elements and spaces required to be accessible under these standards, then 4.1.6(3) does not apply.

(f) No new accessibility alterations will be required of existing elements or spaces previously constructed or altered in compliance with earlier standards issued pursuant to the Architectural Barriers Act of 1968, as amended.

(g) Mechanical rooms and other spaces which normally are not frequented by the public or employees of the building or facility or which by nature of their use are not required by the Architectural Barriers Act to be accessible are excepted from the requirements of 4.1.6.

(2) Where a building or facility is vacated and it is totally altered, then it shall be altered to comply with

4.1.1 to 4.1.5 of 4.1, *Minimum Requirements*, except to the extent where it is structurally impracticable.

(3) Where substantial alteration occurs to a building or facility, then each element or space that is altered or added shall comply with the applicable provisions of 4.1.1 to 4.1.4 of 4.1, *Minimum Requirements*, except to the extent where it is structurally impracticable. The altered building or facility shall contain:

(a) At least one accessible route complying with 4.3, *Accessible Route*, and 4.1.6(a);

(b) At least one accessible entrance complying with 4.14, *Entrances*. If additional entrances are altered then they shall comply with 4.1.6(a); and

(c) The following toilet facilities, whichever is greater:

(i) At least one toilet facility for each sex in the altered building complying with 4.22, *Toilet Rooms*, and 4.23, *Bathrooms, Bathing Facilities, and Shower Rooms*.

(ii) At least one toilet facility for each sex on each substantially altered floor, where such facilities are provided, complying with 4.22, *Toilet Rooms*, and 4.23, *Bathrooms, Bathing Facilities, and Shower Rooms*.

(d) In making the determination as to what constitutes "substantial alteration," the agency issuing standards for the facility shall consider the total cost of all alterations (including but not limited to electrical, mechanical, plumbing, and structural changes) for a building or facility within any twelve (12) month period. For guidance in implementing this provision, an alteration to any building or facility is to be considered substantial if the total cost for this twelve month period amounts to 50 percent or more of the full and fair cash value of the building as defined in 3.5.

EXCEPTION: If the cost of the elements and spaces required by 4.1.6(3)(a), (b), or (c) exceeds 15 percent of the total cost of all other alterations, then a schedule may be established by the standard-setting and/or funding agency to provide the required improvements within a 5-year period.

EXCEPTION: Consideration shall be given to providing accessible elements and spaces in each altered building or facility complying with:

- (i) 4.6, *Parking and Passenger Loading Zones*,
- (ii) 4.15, *Drinking Fountains and Water Coolers*,
- (iii) 4.25, *Storage*,
- (iv) 4.28, *Alarms*,
- (v) 4.31, *Telephones*,
- (vi) 4.32, *Seating, Tables, and Work Surfaces*,
- (vii) 4.33, *Assembly Areas*.

(4) Special technical provisions for alterations to existing buildings or facilities:

4.1.7 Accessible Buildings: Historic Preservation

(a) Ramps. Curb ramps and ramps to be constructed on existing sites or in existing buildings or facilities may have slopes and rises as shown in Table 2 if space limitations prohibit the use of a 1:12 slope or less.

Table 2
Allowable Ramp Dimensions for Construction in Existing Sites, Buildings, and Facilities

Slope*	Maximum Rise		Maximum Run	
	in	mm	ft	m
Steeper than 1:10 but no steeper than 1:8	3	75	2	0.6
Steeper than 1:12 but no steeper than 1:10	6	150	5	1.5

*A slope steeper than 1:8 not allowed.

(b) Stairs. Full extension of stair handrails shall not be required in alterations where such extensions would be hazardous or impossible due to plan configuration.

(c) Elevators.

(i) If a safety door edge is provided in existing automatic elevators, then the automatic door reopening devices may be omitted (see 4.10.6).

(ii) Where existing shaft or structural elements prohibit strict compliance with 4.10.9, then the minimum floor area dimensions may be reduced by the minimum amount necessary, but in no case shall they be less than 48 in by 48 in (1220 mm by 1220 mm).

(d) Doors.

(i) Where existing elements prohibit strict compliance with the clearance requirements of 4.13.5, a projection of 5/8 in (16 mm) maximum will be permitted for the latch side door stop.

(ii) If existing thresholds measure 3/4 in (19 mm) high or less, and are beveled or modified to provide a beveled edge on each side, then they may be retained.

(e) Toilet rooms. Where alterations to existing facilities make strict compliance with 4.22 and 4.23 structurally impracticable, the addition of one "unisex" toilet per floor containing one water closet complying with 4.16 and one lavatory complying

with 4.19, located adjacent to existing toilet facilities, will be acceptable in lieu of making existing toilet facilities for each sex accessible.

EXCEPTION: In instances of alteration work where provision of a standard stall (Fig. 30(a)) is structurally impracticable or where plumbing code requirements prevent combining existing stalls to provide space, an alternate stall (Fig. 30(b)) may be provided in lieu of the standard stall.

(f) Assembly areas.

(i) In alterations where it is structurally impracticable to disperse seating throughout the assembly area, seating may be located in collected areas as structurally feasible. Seating shall adjoin an accessible route that also serves as a means of emergency egress.

(ii) In alterations where it is structurally impracticable to alter all performing areas to be on an accessible route, then at least one of each type shall be made accessible.

(5) Housing. (Reserved).

4.1.7 Accessible Buildings: Historic Preservation.

(1) Applicability.

(a) As a general rule, the accessibility provisions of part 4 shall be applied to "qualified" historic buildings and facilities. "Qualified" buildings or facilities are those buildings and facilities that are eligible for listing in the National Register of Historic Places, or such properties designated as historic under a statute of the appropriate state or local government body. Comments of the Advisory Council on Historic Preservation shall be obtained when required by Section 106 of the National Historic Preservation Act of 1966, as amended, 16 U.S.C. 470 and 36 CFR Part 800, before any alteration to a qualified historic building.

(b) The Advisory Council shall determine, on a case-by-case basis, whether provisions required by part 4 for accessible routes (exterior and interior), ramps, entrances, toilets, parking, and displays and signage, would threaten or destroy the historic significance of the building or facility.

(c) If the Advisory Council determines that any of the accessibility requirements for features listed in 4.1.7(1) would threaten or destroy the historic significance of a building or facility, then the special application provisions of 4.1.7(2) for that feature may be utilized. The special application provisions listed under 4.1.7(2) may only be utilized following a written determination by the Advisory Council that application of a requirement contained in part 4 would threaten or destroy the historic integrity of a qualified building or facility.

4.1.7 Accessible Buildings: Historic Preservation

(2) Historic Preservation: Minimum Requirements.

(a) At least one accessible route complying with 4.3 from a site access point to an accessible entrance shall be provided.

EXCEPTION: A ramp with a slope no greater than 1:6 for a run not to exceed 2 ft (610 mm) may be used as part of an accessible route at an entrance.

(b) At least one accessible entrance which is used by the public complying with 4.14 shall be provided.

EXCEPTION: If it is determined that no entrance used by the public can comply with 4.14, then access at any entrance not used by the general public but open (unlocked) with directional signs at the primary entrance may be used.

(c) If toilets are provided, then at least one toilet facility complying with 4.22 and 4.1.6 shall be provided along an accessible route that complies with 4.3. Such toilet facility may be "unisex" in design.

(d) Accessible routes from an accessible entrance to all publicly used spaces on at least the level of the accessible entrance shall be provided. Access should be provided to all levels of a building or facility in compliance with 4.1 whenever practical.

(e) Displays and written information, documents, etc., should be located where they can be seen by a seated person. Exhibits and signage displayed horizontally, e.g., books, should be no higher than 44 in (1120 mm) above the floor surface.

4.2 Space Allowance and Reach Ranges

4.2.1* Wheelchair Passage Width. The minimum clear width for single wheelchair passage shall be 32 in (815 mm) at a point and 36 in (915 mm) continuously (see Fig. 1 and 24(e)).

4.2.2 Width for Wheelchair Passing. The minimum width for two wheelchairs to pass is 60 in (1525 mm) (see Fig. 2).

4.2.3* Wheelchair Turning Space. The space required for a wheelchair to make a 180-degree turn is a clear space of 60 in (1525 mm) diameter (see Fig. 3(a)) or a T-shaped space (see Fig. 3(b)).

4.2.4* Clear Floor or Ground Space for Wheelchairs.

4.2.4.1 Size and Approach. The minimum clear floor or ground space required to accommodate a single, stationary wheelchair occupant is 30 in by 48 in (760 mm by 1220 mm) (see Fig. 4(a)). The minimum clear floor or ground space for wheelchairs may be positioned for forward or parallel approach to an object

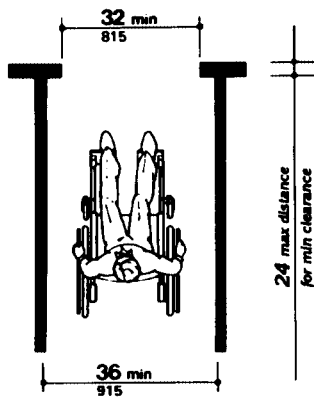


Fig. 1
Minimum Clear Width
for Single Wheelchair

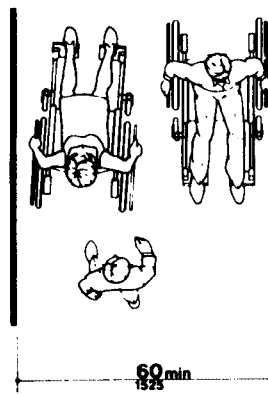
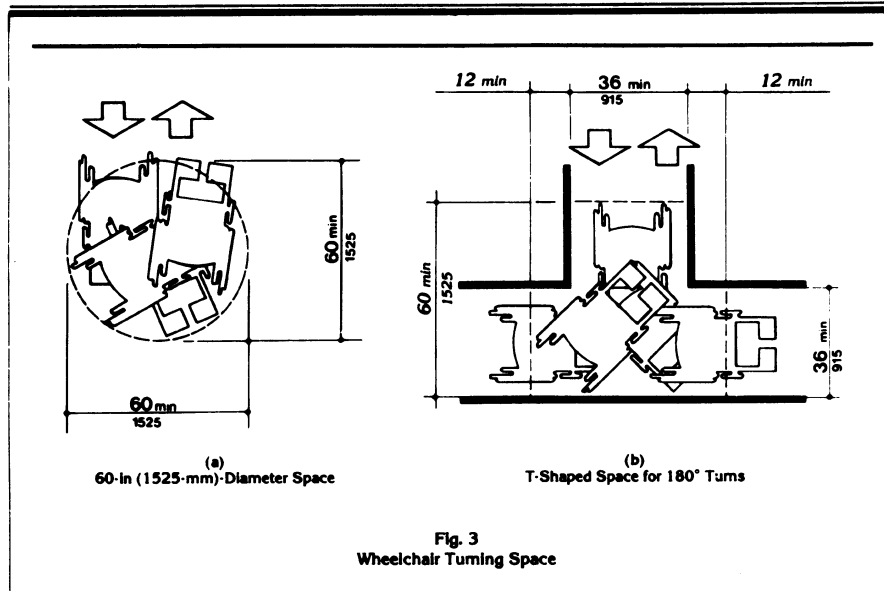


Fig. 2
Minimum Clear Width
for Two Wheelchairs

4.3 Accessible Route



(see Fig. 4(b) and (c)). Clear floor or ground space for wheelchairs may be part of the knee space required under some objects.

4.2.4.2 Relationship of Maneuvering Clearance to Wheelchair Spaces. One full unobstructed side of the clear floor or ground space for a wheelchair shall adjoin or overlap an accessible route or adjoin another wheelchair clear floor space. If a clear floor space is located in an alcove or otherwise confined on all or part of three sides, additional maneuvering clearances shall be provided as shown in Fig. 4(d) and (e).

4.2.4.3 Surfaces for Wheelchair Spaces. Clear floor or ground spaces for wheelchairs shall comply with 4.5.

4.2.5 Forward Reach. If the clear floor space only allows forward approach to an object, the maximum high forward reach allowed shall be 48 in (1220 mm) (see Fig. 5(a)). The minimum low forward reach is 15 in (380 mm). If the high forward reach is over an obstruction, reach and clearances shall be as shown in Fig. 5(b).

4.2.6* Side Reach. If the clear floor space allows parallel approach by a person in a wheelchair, the maximum high side reach allowed shall be 54 in (1370 mm) and the low side reach shall be no less than 9 in (230 mm) above the floor (Fig. 6(a) and (b)).

If the side reach is over an obstruction, the reach and clearances shall be as shown in Fig. 6(c).

4.3 Accessible Route.

4.3.1* General. All walks, halls, corridors, aisles, and other spaces that are part of an accessible route shall comply with 4.3.

4.3.2 Location.

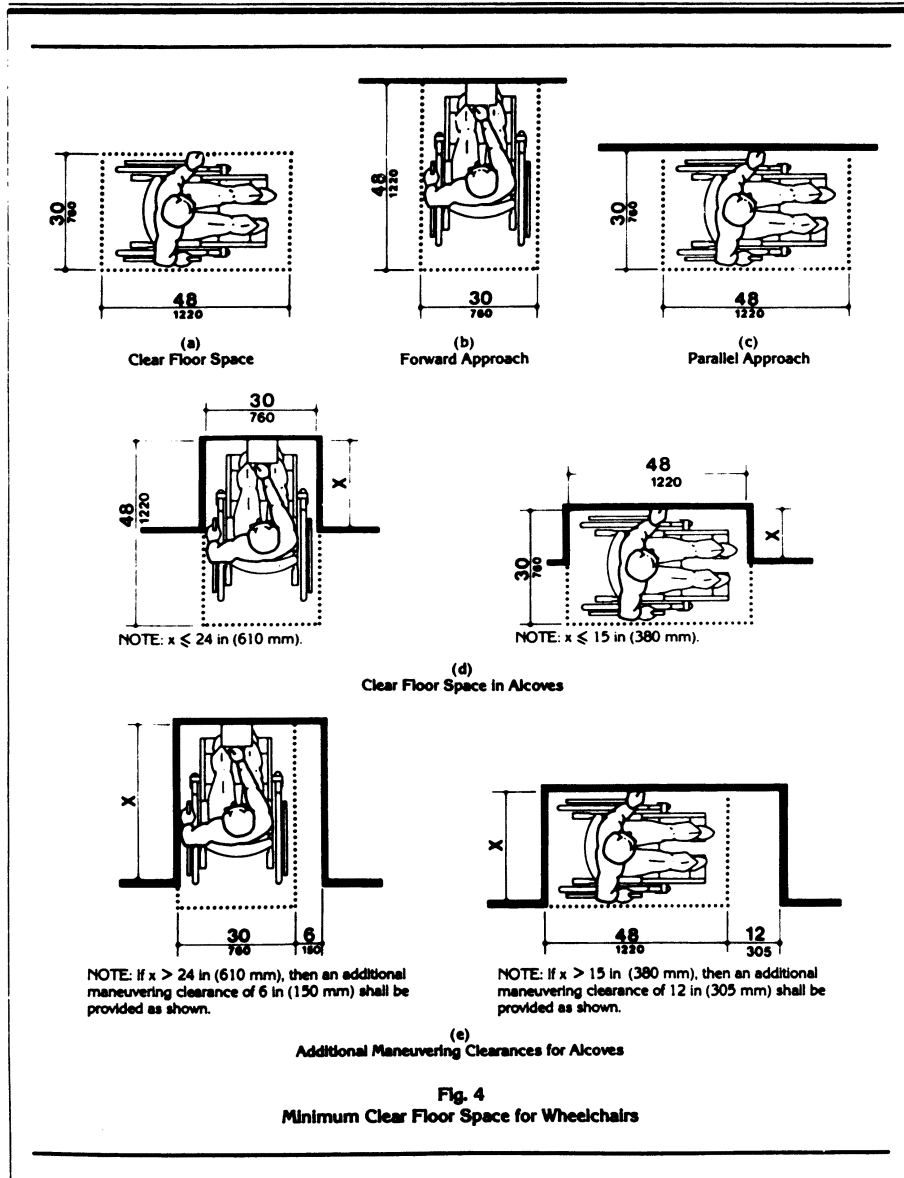
(1) At least one accessible route *within the boundary of the site* shall be provided from public transportation stops, accessible parking, and accessible passenger loading zones, and public streets or sidewalks to the accessible building entrance they serve.

(2) At least one accessible route shall connect accessible buildings, facilities, elements, and spaces that are on the same site.

(3) At least one accessible route shall connect accessible building or facility entrances with all accessible spaces and elements and with all accessible dwelling units within the building or facility.

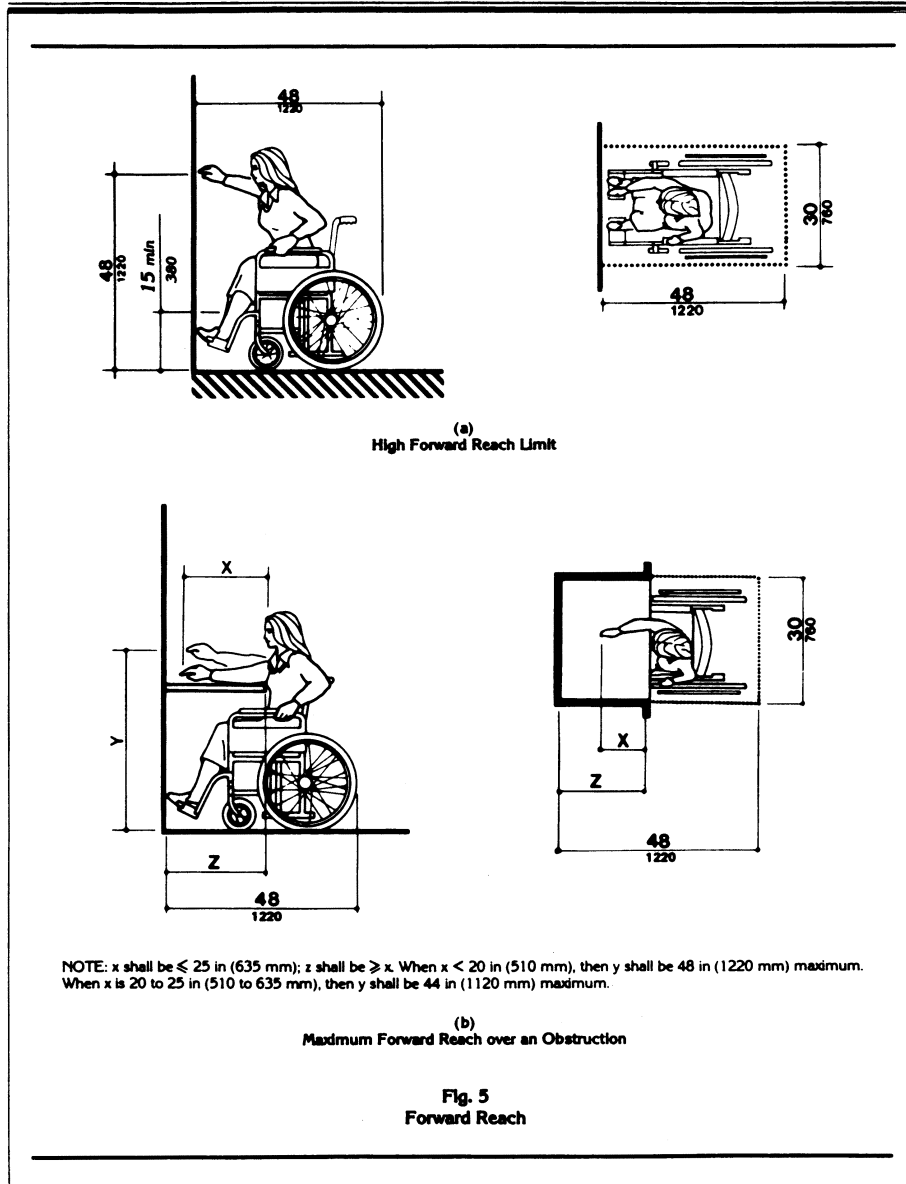
(4) An accessible route shall connect at least one accessible entrance of each accessible dwelling unit with those exterior and interior spaces and facilities that serve the accessible dwelling unit.

4.3 Accessible Route

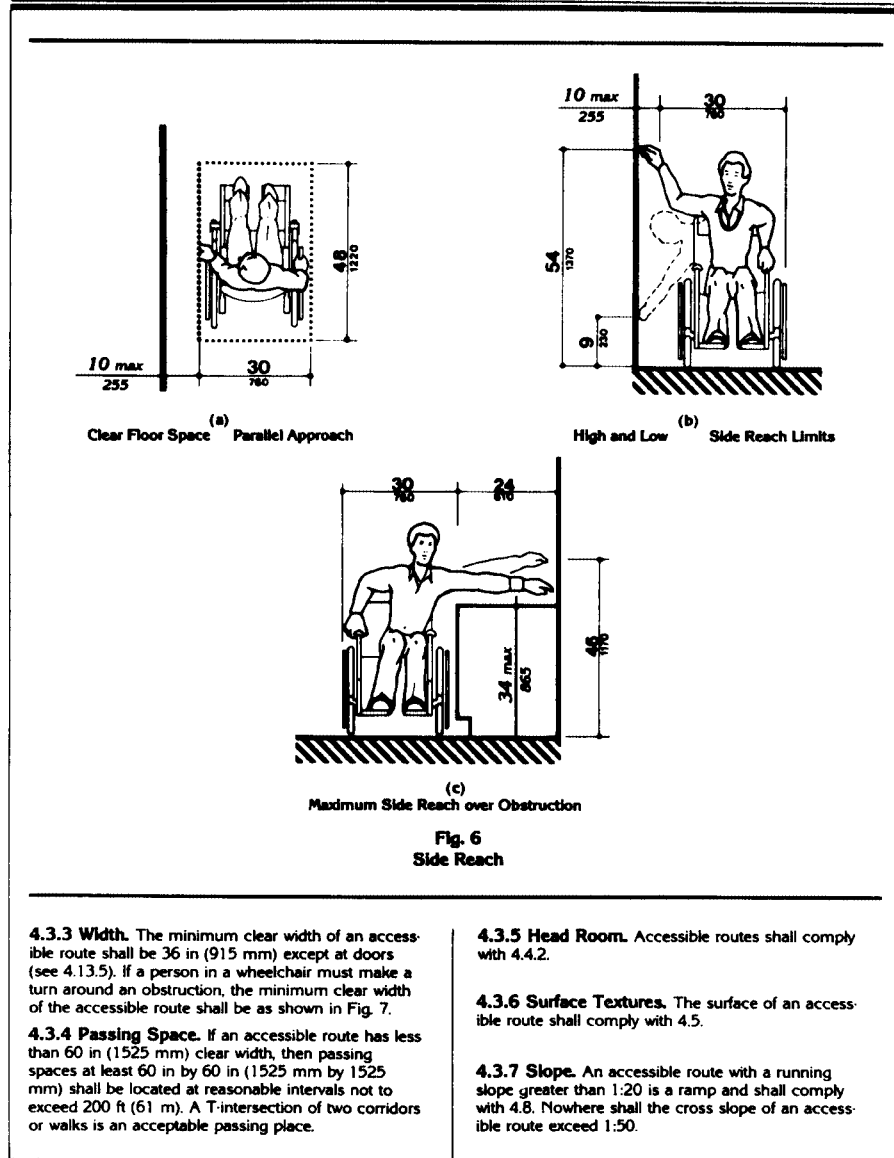


16

4.3 Accessible Route



4.3 Accessible Route



4.3 Accessible Route

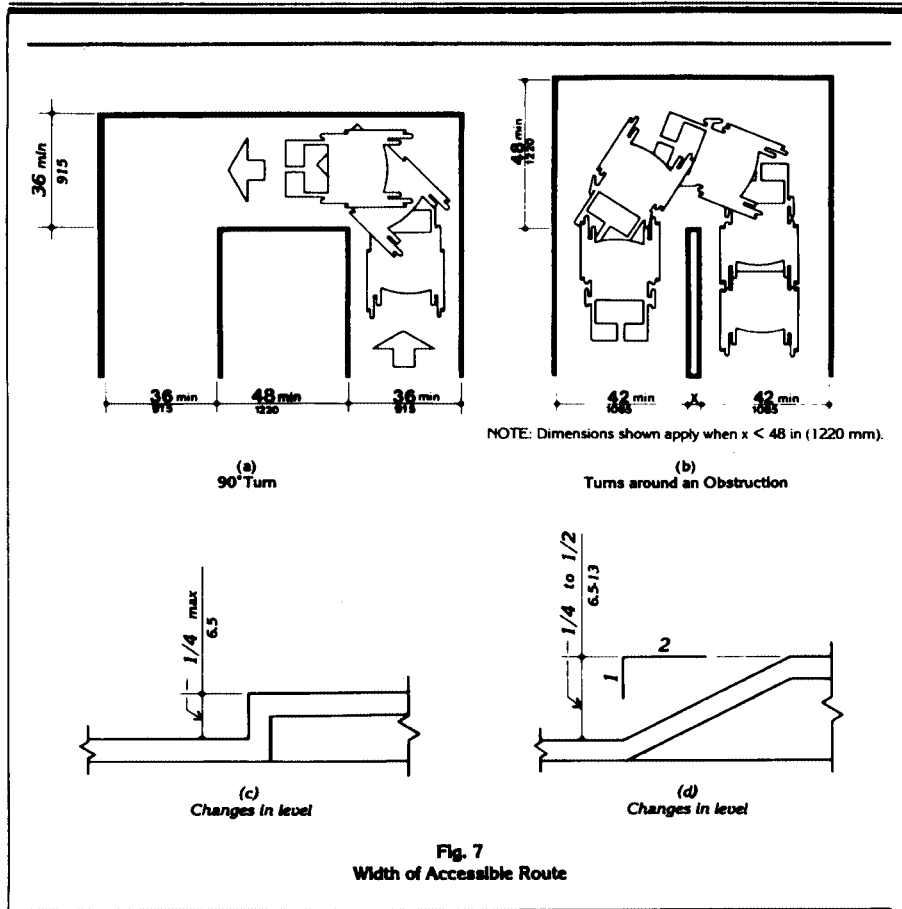


Fig. 7
Width of Accessible Route

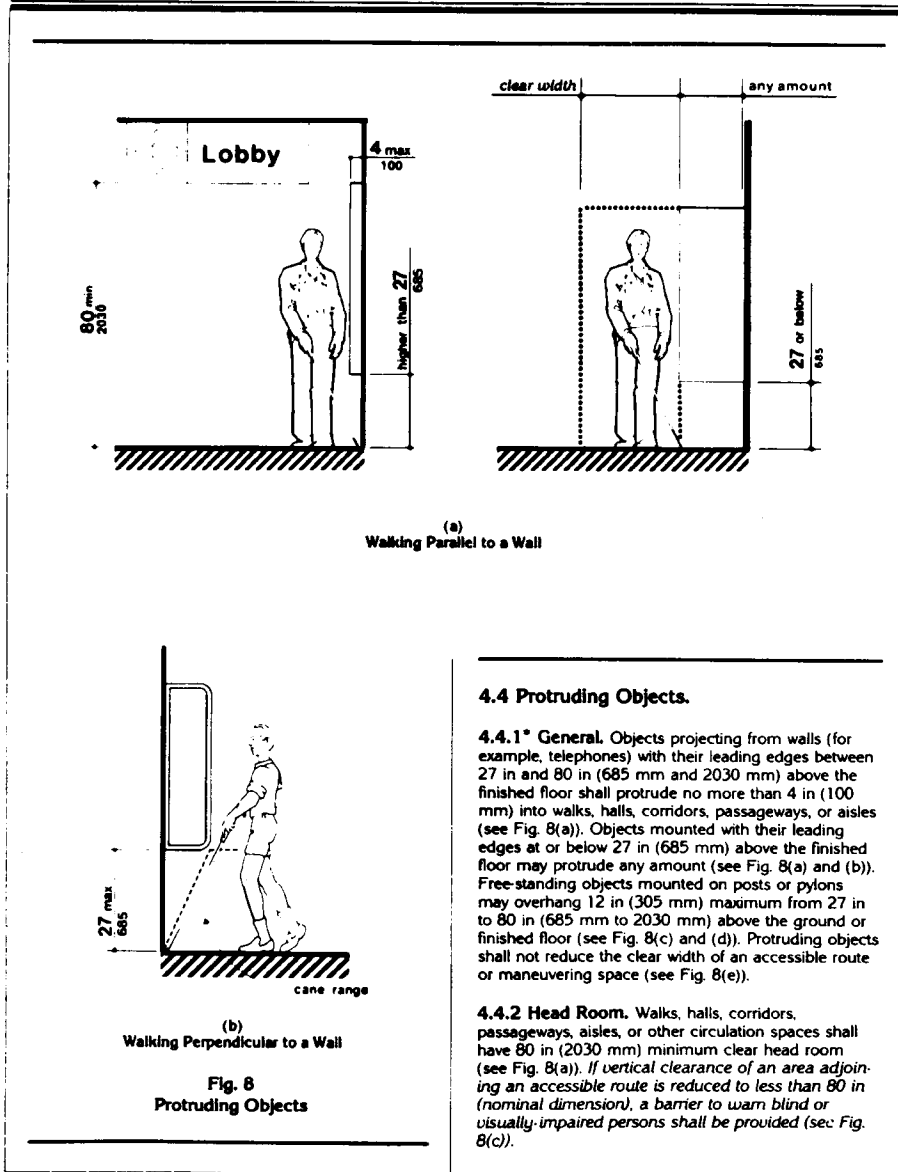
4.3.8 Changes in Levels. Changes in levels along an accessible route shall comply with 4.5.2. If an accessible route has changes in level greater than 1/2 in (13 mm), then a curb ramp, ramp, elevator, or platform lift shall be provided that complies with 4.7, 4.8, 4.10, or 4.11, respectively. Stairs shall not be part of an accessible route.

4.3.9 Doors. Doors along an accessible route shall comply with 4.13.

4.3.10^a Egress. Accessible routes serving any

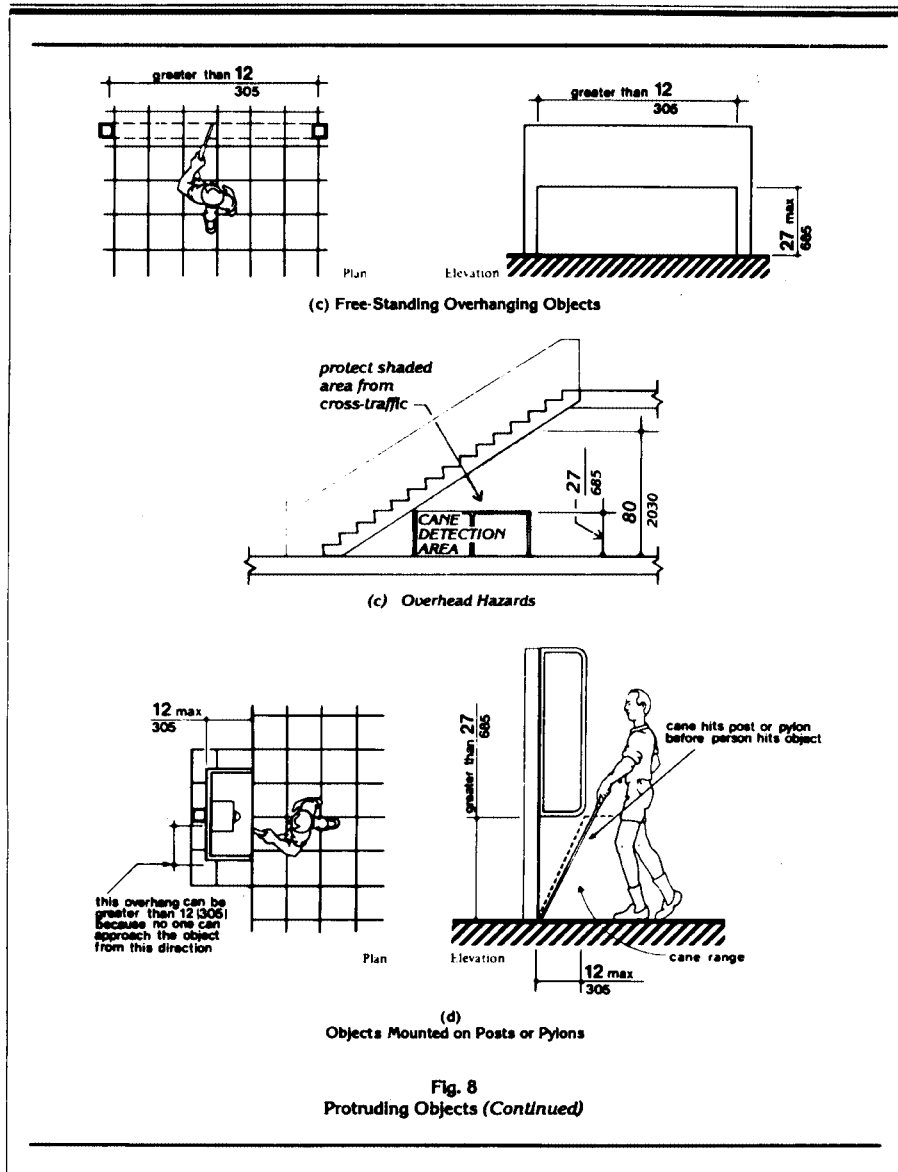
accessible space or element shall also serve as a means of egress for emergencies or connect to an accessible place of refuge. Such accessible routes and places of refuge shall comply with the requirements of the administrative authority having jurisdiction. *Where fire code provisions require more than one means of egress from any space or room, then more than one accessible means of egress shall also be provided for handicapped people. Arrange egress so as to be readily accessible from all accessible rooms and spaces.*

4.4 Protruding Objects

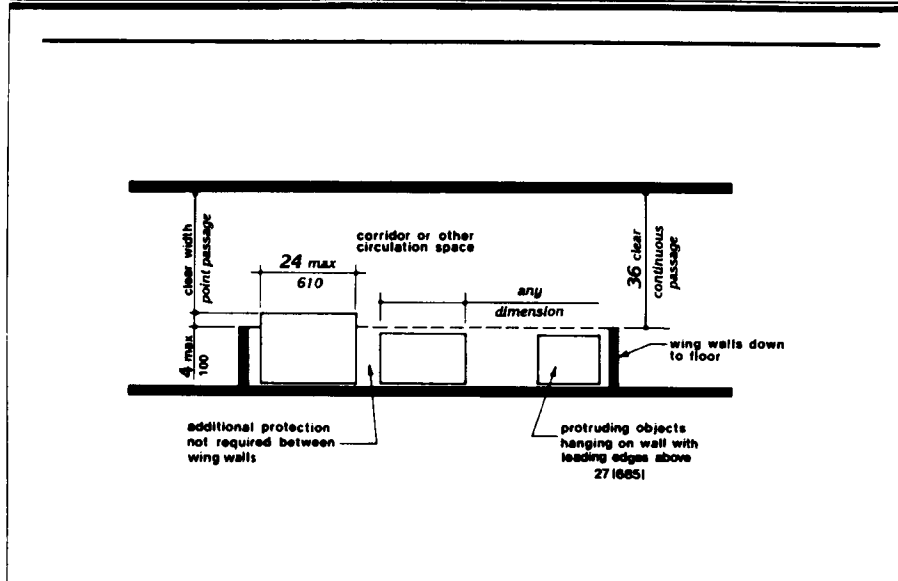


20

4.4 Protruding Objects



4.4 Protruding Objects



(e)
Example of Protection around Wall-Mounted Objects and Measurements of Clear Widths

Fig. 8
Protruding Objects (Continued)

4.5 Ground and Floor Surfaces.

4.5.1* General. Ground and floor surfaces along accessible routes and in accessible rooms and spaces, including floors, walks, ramps, stairs, and curb ramps, shall be stable, firm, slip-resistant, and shall comply with 4.5.

4.5.2 Changes in Level. Changes in level up to 1/4 in (6 mm) may be vertical and without edge treatment (see Fig. 7(c)). Changes in level between 1/4 in and 1/2 in (6 mm and 13 mm) shall be beveled with a slope no greater than 1:2 (see Fig. 7(d)). Changes in level greater than 1/2 in (13 mm) shall be accomplished by means of a ramp that complies with 4.7 or 4.8.

4.5.3* Carpet. If carpet or carpet tile is used on a ground or floor surface, then it shall be securely

attached; have a firm cushion, pad, or backing or no cushion or pad; and have a level loop, textured loop, level cut pile, or level cut/uncut pile texture. The maximum pile height shall be 1/2 in (13 mm). Exposed edges of carpet shall be fastened to floor surfaces and have trim along the entire length of the exposed edge. Carpet edge trim shall comply with 4.5.2. If carpet tile is used on an accessible ground or floor surface, it shall have a maximum combined thickness of pile, cushion, and backing height of 1/2 in (13 mm) (see Fig. 8(f)).

4.5.4 Gratings. If gratings are located in walking surfaces, then they shall have spaces no greater than 1/2 in (13 mm) wide in one direction (see Fig. 8(g)). If gratings have elongated openings, then they shall be placed so that the long dimension is perpendicular to the dominant direction of travel (see Fig. 8(h)).

4.6 Parking and Passenger Loading Zones

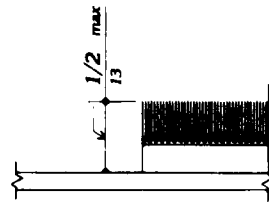


Fig. 8(f)
Carpet Tile Thickness

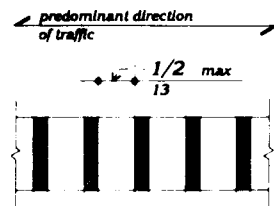


Fig. 8(g)
Gratings

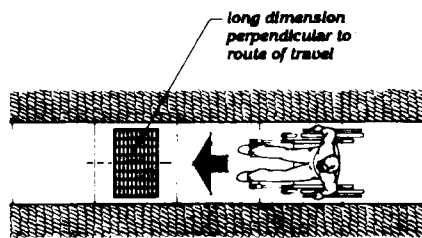


Fig. 8(h)
Grating Orientation

4.6 Parking and Passenger Loading Zones.

4.6.1 Minimum Number. Parking spaces required to be accessible by 4.1 shall comply with 4.6.2 through 4.6.4. Passenger loading zones required to be accessible by 4.1 shall comply with 4.6.5 and 4.6.6.

4.6.2 Location. Parking spaces for disabled people and accessible passenger loading zones that serve a particular building shall be the spaces or zones located closest to the nearest accessible entrance on an accessible route. In separate parking structures or lots that do not serve a particular building, parking spaces for disabled people shall be located on the shortest possible circulation route to an accessible pedestrian entrance of the parking facility.

4.6.3* Parking Spaces. Parking spaces for disabled people shall be at least 96 in (2440 mm) wide and shall have an adjacent access aisle 60 in (1525 mm) wide minimum (see Fig. 9). Parking access aisles shall be part of an accessible route to the building or facility entrance and shall comply with 4.3. Two accessible parking spaces may share a common access aisle. Parked vehicle overhangs shall not reduce the clear width of an accessible circulation route. Parking spaces and access aisles shall be level with surface slopes not exceeding 1:50 in all directions.

EXCEPTION: If accessible parking spaces for vans designed for handicapped persons are provided, each should have an adjacent access aisle at least 96 in (2440 mm) wide complying with 4.5, Ground and Floor Surfaces.

4.6.4* Signage. Accessible parking spaces shall be designated as reserved for the disabled by a sign showing the symbol of accessibility (see 4.30.5). Such signs shall not be obscured by a vehicle parked in the space.

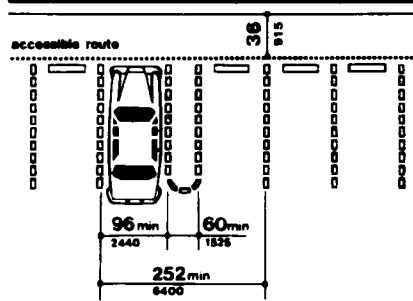


Fig. 9
Dimensions of Parking Spaces

4.6 Parking and Passenger Loading Zones

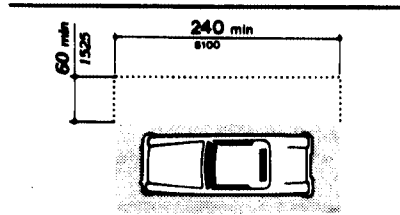


Fig. 10
Access Aisle at Passenger Loading Zones

4.6.5 Passenger Loading Zones. Passenger loading zones shall provide an access aisle at least 60 in (1525 mm) wide and 20 ft (6 m) long adjacent and parallel to the vehicle pull-up space (see Fig. 10). If there are curbs between the access aisle and the

vehicle pull-up space, then a curb ramp complying with 4.7 shall be provided. Vehicle standing spaces and access aisles shall be level with surface slopes not exceeding 1:50 in all directions.

4.6.6 Vertical Clearance. Provide minimum vertical clearances of 114 in at accessible passenger loading zones and along vehicle access routes to such areas from site entrances. If accessible van parking spaces are provided, then the minimum vertical clearance should be 114 in.

4.7 Curb Ramps.

4.7.1 Location. Curb ramps complying with 4.7 shall be provided wherever an accessible route crosses a curb.

4.7.2 Slope. Slopes of curb ramps shall comply with 4.8.2. The slope shall be measured as shown in Fig. 11. Transitions from ramps to walks, gutters, or streets shall be flush and free of abrupt changes. Maximum slopes of adjoining gutters, road surface immediately adjacent to the curb ramp, or accessible route shall not exceed 1:20.

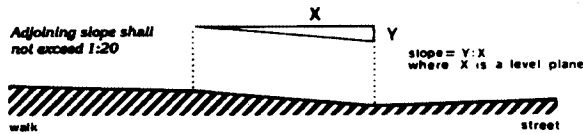
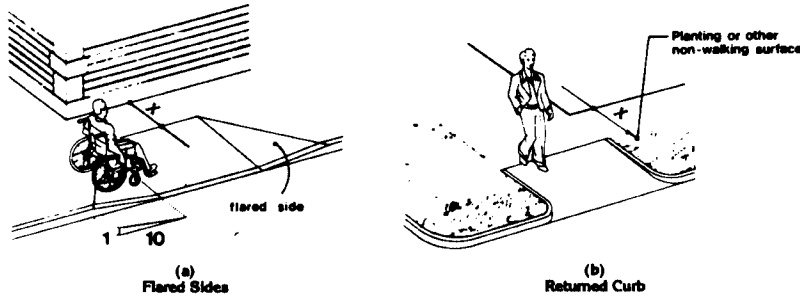


Fig. 11
Measurement of Curb Ramp Slopes



If X is less than 48 in, then the slope of the flared side shall not exceed 1:12.

Fig. 12
Sides of Curb Ramps

4.8 Ramps

4.7.3 Width. The minimum width of a curb ramp shall be 36 in (915 mm), exclusive of flared sides.

4.7.4 Surface. Surfaces of curb ramps shall comply with 4.5.

4.7.5 Sides of Curb Ramps. If a curb ramp is located where pedestrians must walk across the ramp, or where it is not protected by handrails or guardrails, then it shall have flared sides; the maximum slope of the flare shall be 1:10 (see Fig. 12(a)). Curb ramps with returned curbs may be used where pedestrians would not normally walk across the ramp (see Fig. 12(b)).

4.7.6 Built-up Curb Ramps. Built-up curb ramps shall be located so that they do not project into vehicular traffic lanes (see Fig. 13).

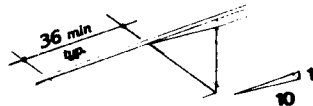


Fig. 13
Built-Up Curb Ramp

4.7.7 Warning Textures. (Removed and reserved).

4.7.8 Obstructions. Curb ramps shall be located or protected to prevent their obstruction by parked vehicles.

4.7.9 Location at Marked Crossings. Curb ramps at marked crossings shall be wholly contained within the markings, excluding any flared sides (see Fig. 15).

4.7.10 Diagonal Curb Ramps. If diagonal (or corner type) curb ramps have returned curbs or other well-defined edges, such edges shall be parallel to the direction of pedestrian flow. The bottom of diagonal curb ramps shall have 48 in (1220 mm) minimum clear space as shown in Fig. 15(c) and (d). If diagonal curb ramps are provided at marked crossings, the 48 in (1220 mm) clear space shall be within the markings (see Fig. 15(c) and (d)). If diagonal curb ramps have flared sides, they shall also have at least a 24 in (610 mm) long segment of straight curb located on each side of the curb ramp and within the marked crossing (see Fig. 15(c)).

4.7.11 Islands. Any raised islands in crossings shall be cut through level with the street or have curb ramps at both sides and a level area at least 48 in (1220 mm) long in the part of the island intersected by the crossings (see Fig. 15(a) and (b)).

4.7.12 Uncurbed Intersections. (Removed and reserved).

4.8 Ramps.

4.8.1* General. Any part of an accessible route with a slope greater than 1:20 shall be considered a ramp and shall comply with 4.8.

4.8.2* Slope and Rise. The least possible slope shall be used for any ramp. The maximum slope of a ramp in new construction shall be 1:12. The maximum rise for any run shall be 30 in (760 mm) (see Fig. 16). Curb ramps and ramps to be constructed on existing sites or in existing buildings or facilities may have slopes and rises as shown in Table 2 if space limitations prohibit the use of a 1:12 slope or less (see 4.1.5).

4.8.3 Clear Width. The minimum clear width of a ramp shall be 36 in (915 mm).

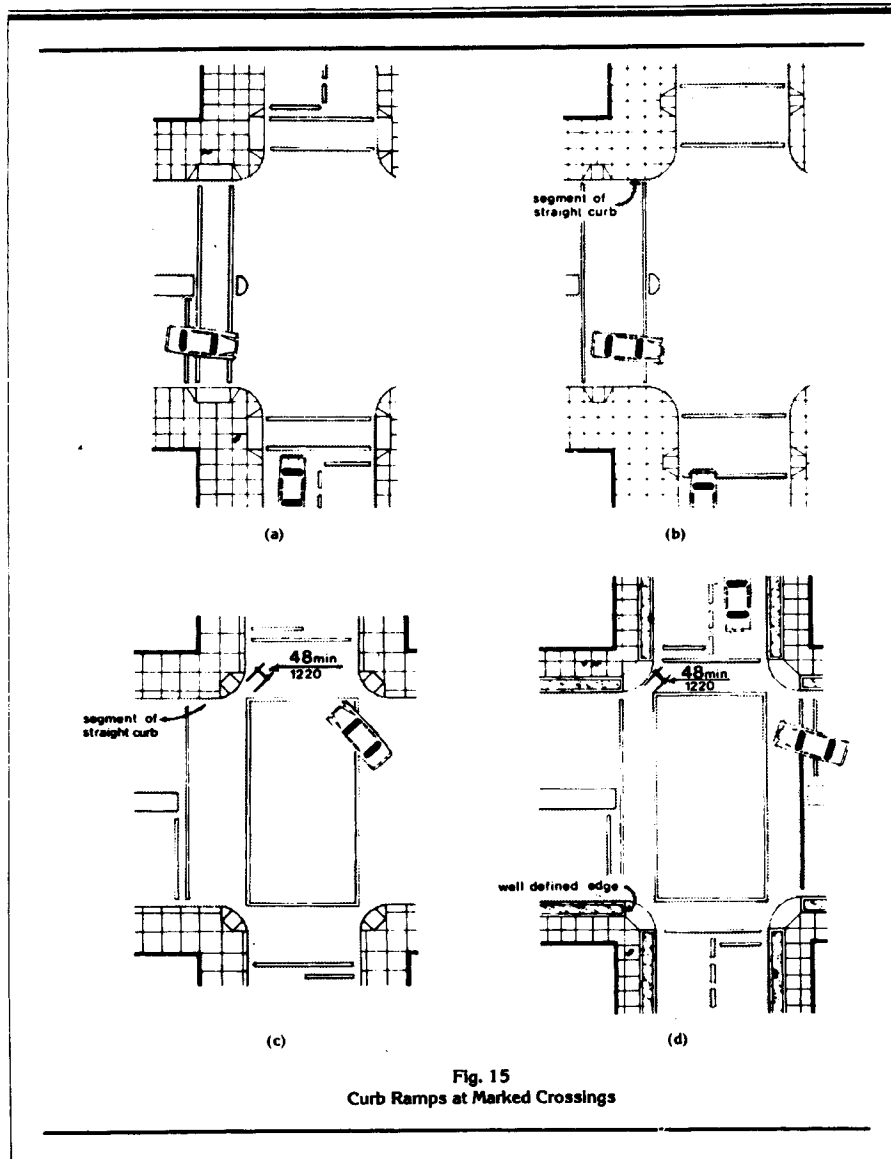
4.8.4 Landings. Ramps shall have level landings at the bottom and top of each run. Landings shall have the following features:

- (1) The landing shall be at least as wide as the ramp run leading to it.
- (2) The landing length shall be a minimum of 60 in (1525 mm) clear.
- (3) If ramps change direction at landings, the minimum landing size shall be 60 in by 60 in (1525 mm by 1525 mm).
- (4) If a doorway is located at a landing, then the area in front of the doorway shall comply with 4.13.6.

4.8.5* Handrails. If a ramp run has a rise greater than 6 in (250 mm) or a horizontal projection greater than 72 in (1830 mm), then it shall have handrails on both sides. Handrails are not required on curb ramps. Handrails shall comply with 4.26 and shall have the following features:

- (1) Handrails shall be provided along both sides of ramp segments. The inside handrail on switchback or dogleg ramps shall always be continuous.
- (2) If handrails are not continuous, they shall extend at least 12 in (305 mm) beyond the top and bottom of the ramp segment and shall be parallel with the floor or ground surface.
- (3) The clear space between the handrail and the wall shall be 1-1/2 in (38 mm).
- (4) Gripping surfaces shall be continuous.
- (5) Top of handrail gripping surfaces shall be mounted between 30 in and 34 in (760 mm and 865 mm) above ramp surfaces.
- (6) Ends of handrails shall be either rounded or returned smoothly to floor, wall, or post.
- (7) Handrails shall not rotate within their fittings.

4.8 Ramps



4.9 Stairs

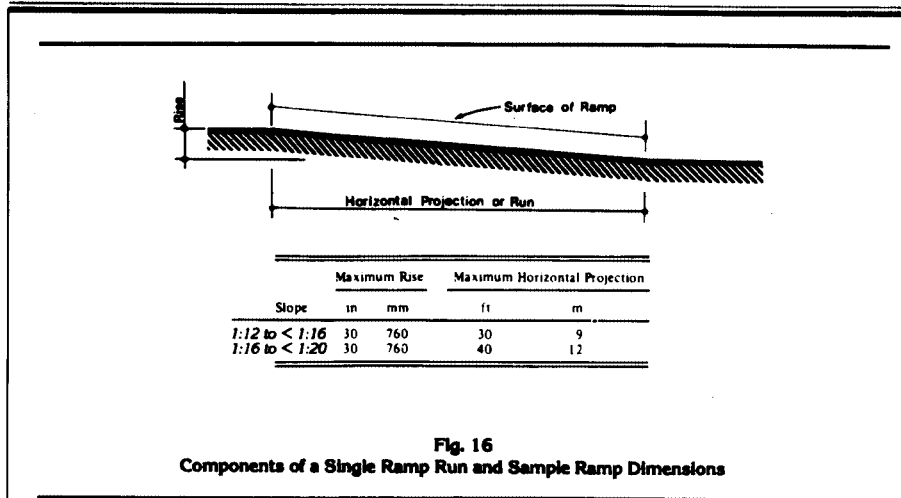


Fig. 16
Components of a Single Ramp Run and Sample Ramp Dimensions

4.8.6 Cross Slope and Surfaces. The cross slope of ramp surfaces shall be no greater than 1:50. Ramp surfaces shall comply with 4.5.

4.8.7 Edge Protection. Ramps and landings with drop-offs shall have curbs, walls, railings, or projecting surfaces that prevent people from slipping off the ramp. Curbs shall be a minimum of 2 in (50 mm) high (see Fig. 17).

4.8.8 Outdoor Conditions. Outdoor ramps and their approaches shall be designed so that water will not accumulate on walking surfaces.

4.9 Stairs.

4.9.1 Minimum Number. Stairs required to be accessible by 4.1 shall comply with 4.9.

4.9.2 Treads and Risers. On any given flight of stairs, all steps shall have uniform riser heights and uniform tread widths. Stair treads shall be no less than 11 in (280 mm) wide, measured from riser to riser (see Fig. 18(a)). Open risers are not permitted on accessible routes.

4.9.3 Nosings. The undersides of nosings shall not be abrupt. The radius of curvature at the leading edge of the tread shall be no greater than 1/2 in (13 mm). Risers shall be sloped or the underside of the nosing shall have an angle not less than 60 degrees from the horizontal. Nosings shall project no more than 1-1/2 in (38 mm) (see Fig. 18).

4.9.4 Handrails. Stairways shall have handrails at both sides of all stairs. Handrails shall comply with 4.26 and shall have the following features:

(1) Handrails shall be continuous along both sides of stairs. The inside handrail on switchback or dogleg stairs shall always be continuous (see Fig. 19(a) and (b)).

(2) If handrails are not continuous, they shall extend at least 12 in (305 mm) beyond the top riser and at least 12 in (305 mm) plus the width of one tread beyond the bottom riser. At the top, the extension shall be parallel with the floor or ground surface. At the bottom, the handrail shall continue to slope for a distance of the width of one tread from the bottom riser; the remainder of the extension shall be horizontal (see Fig. 19(c) and (d)). Handrail extensions shall comply with 4.4.

(3) The clear space between handrails and wall shall be 1-1/2 in (38 mm).

(4) Gripping surfaces shall be uninterrupted by newel posts, other construction elements, or obstructions.

(5) Top of handrail gripping surface shall be mounted between 30 in and 34 in (760 mm and 865 mm) above stair nosings.

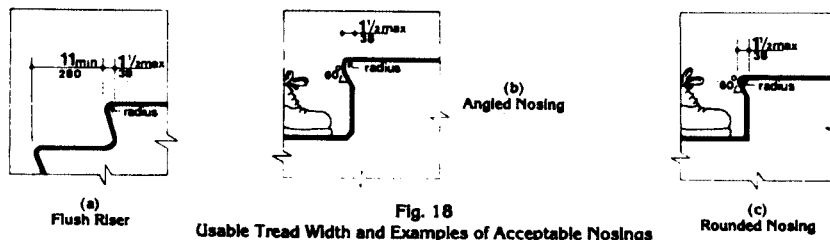
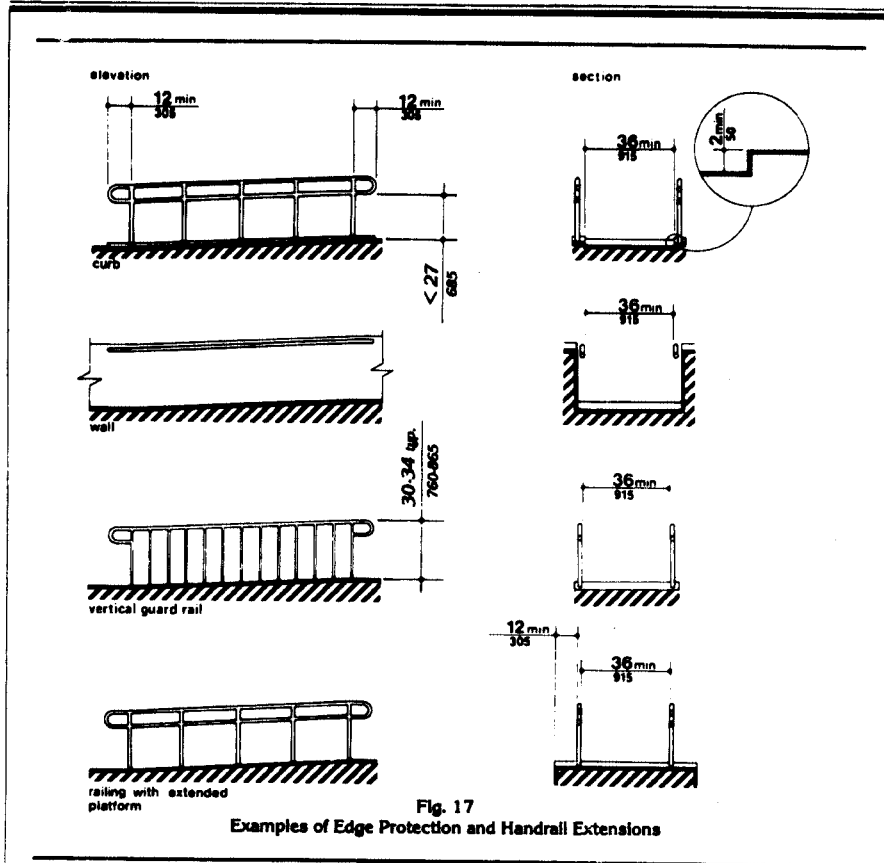
(6) Ends of handrails shall be either rounded or returned smoothly to floor, wall, or post.

(7) Handrails shall not rotate within their fittings.

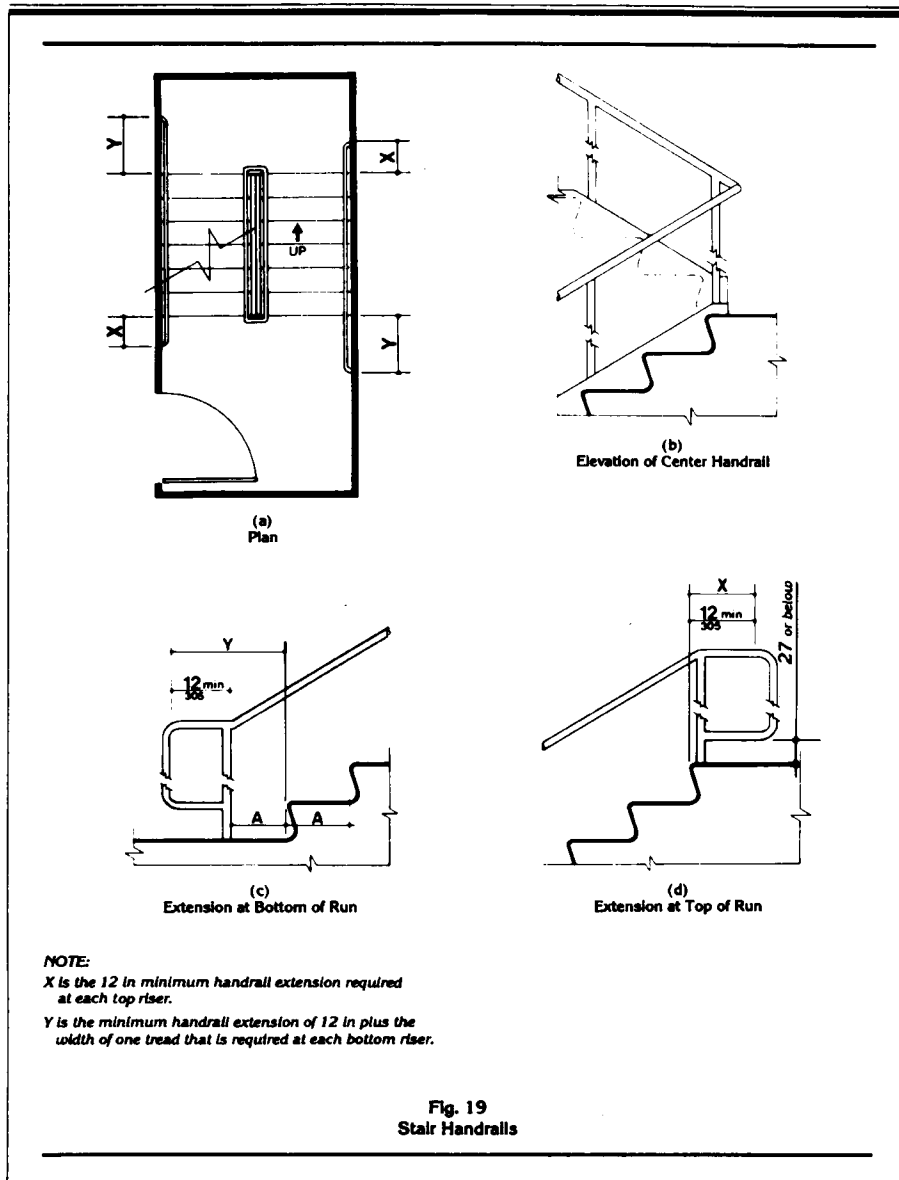
4.9.5 Tactile Warnings at Stairs. (Removed and reserved).

4.9.6 Outdoor Conditions. Outdoor stairs and their approaches shall be designed so that water will not accumulate on walking surfaces.

4.9 Stairs



4.9 Stairs



4.10 Elevators

4.10 Elevators.

4.10.1 General. Accessible elevators shall be on an accessible route and shall comply with 4.10 and with the American National Standard Safety Code for Elevators, Dumbwaiters, Escalators, and Moving Walks, ANSI A17.1-1978 and A17.1a-1979. This standard does not preclude the use of residential or fully enclosed wheelchair lifts when appropriate and approved by administrative authorities. *Freight elevators shall not be considered as meeting the requirements of this section, unless the only elevators provided are used as combination passenger and freight elevators for the public and employees.*

4.10.2 Automatic Operation. Elevator operation shall be automatic. Each car shall be equipped with a self-leveling feature that will automatically bring the car to floor landings within a tolerance of 1/2 in (13 mm) under rated loading to zero loading conditions. This self-leveling feature shall be automatic and independent of the operating device and shall correct the over-travel or undertravel.

4.10.3 Hall Call Buttons. Call buttons in elevator lobbies and halls shall be centered at 42 in (1065 mm) above the floor. Such call buttons shall have visual signals to indicate when each call is registered and when each call is answered. Call buttons shall be a minimum of 3/4 in (19 mm) in the smallest dimension. The button designating the up direction shall be on top (see Fig. 20) *Buttons shall be raised or flush. Objects mounted beneath hall call buttons shall not project into the elevator lobby more than 4 in (100 mm).*

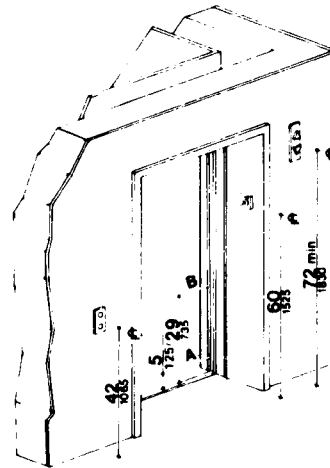
4.10.4 Hall Lanterns. A visible and audible signal shall be provided at each hoistway entrance to indicate which car is answering a call. Audible signals shall sound once for the up direction and twice for the down direction or shall have verbal annunciators that say "up" or "down." Visible signals shall have the following features:

(1) Hall lantern fixtures shall be mounted so that their centerline is at least 72 in (1830 mm) above the lobby floor.

(2) Visual elements shall be at least 2-1/2 in (64 mm) in the smallest dimension.

(3) Signals shall be visible from the vicinity of the hall call button, in-car lanterns located in cars, visible from the vicinity of hall call buttons, and conforming to the above requirements, shall be acceptable (see Fig. 20).

4.10.5 Raised Characters on Hoistway Entrances. All elevator hoistway entrances shall have raised floor designations provided on both jambs. The centerline of the characters shall be 60 in (1525 mm) from the floor. Such characters shall be 2 in (50 mm) high and shall comply with 4.30. Permanently applied plates are acceptable if they are permanently fixed to the jambs. (See Fig. 20).



NOTE: The automatic door reopening device is activated if an object passes through either line A or line B. Line A and line B represent the vertical locations of the door reopening device not requiring contact.

Fig. 20
Hoistway and Elevator Entrances

4.10.6* Door Protective and Reopening Device. Elevator doors shall open and close automatically. They shall be provided with a reopening device that will stop and reopen a car door and hoistway door automatically if the door becomes obstructed by an object or person. The device shall be capable of completing these operations without requiring contact for an obstruction passing through the opening at heights of 5 in and 29 in (125 mm and 735 mm) from the floor (see Fig. 20). Door reopening devices shall remain effective for at least 20 seconds. After such an interval, doors may close in accordance with the requirements of ANSI A17.1-1978 and A17.1a-1979.

4.10.7* Door and Signal Timing for Hall Calls. The minimum acceptable time from notification that a car is answering a call until the doors of that car start to close shall be calculated from the following equation:

$$T = \frac{D}{1.5 R/s} \quad \text{or} \quad T = \frac{D}{445 \text{ mm/s}}$$

where T = total time in seconds and D = distance (in feet or millimeters) from a point in the lobby or corridor 60 in (1525 mm) directly in front of the farthest

4.10 Elevators

call button controlling that car to the centerline of its hoistway door (see Fig. 21). For cars with in-car lanterns, T begins when the lantern is visible from the vicinity of hall call buttons and an audible signal is sounded. The minimum acceptable notification time shall be 5 seconds.

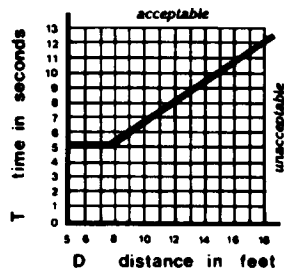


Fig. 21
Graph of Timing Equation

4.10.8 Door Delay for Car Calls. The minimum time for elevator doors to remain fully open in response to a car call shall be 3 seconds.

4.10.9 Floor Plan of Elevator Cars. The floor area of elevator cars shall provide space for wheelchair users to enter the car, maneuver within reach of controls, and exit from the car. Acceptable door opening and inside dimensions shall be as shown in Fig. 22. The clearance between the car platform sill and the edge of any hoistway landing shall be no greater than 1-1/4 in (32 mm).

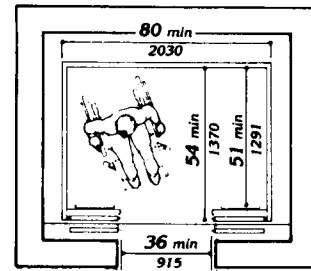
4.10.10 Floor Surfaces. Floor surfaces shall comply with 4.5.

4.10.11 Illumination Levels. The level of illumination at the car controls, platform, and car threshold and landing sill shall be at least 5 footcandles (53.8 lux).

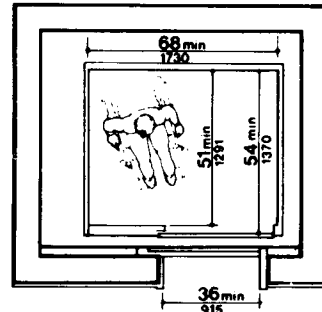
4.10.12* Car Controls. Elevator control panels shall have the following features:

(1) Buttons. All control buttons shall be at least 3/4 in (19 mm) in their smallest dimension. They may be raised or flush.

(2) Tactile and Visual Control Indicators. All control buttons shall be designated by raised standard alphabet characters for letters, arabic characters for numerals, or standard symbols as shown in Fig. 23(a), and as required in ANSI A17.1-1978 and A17.1-1979. Raised characters and symbols shall comply with 4.30. The call button for the main entry floor shall be



(a)



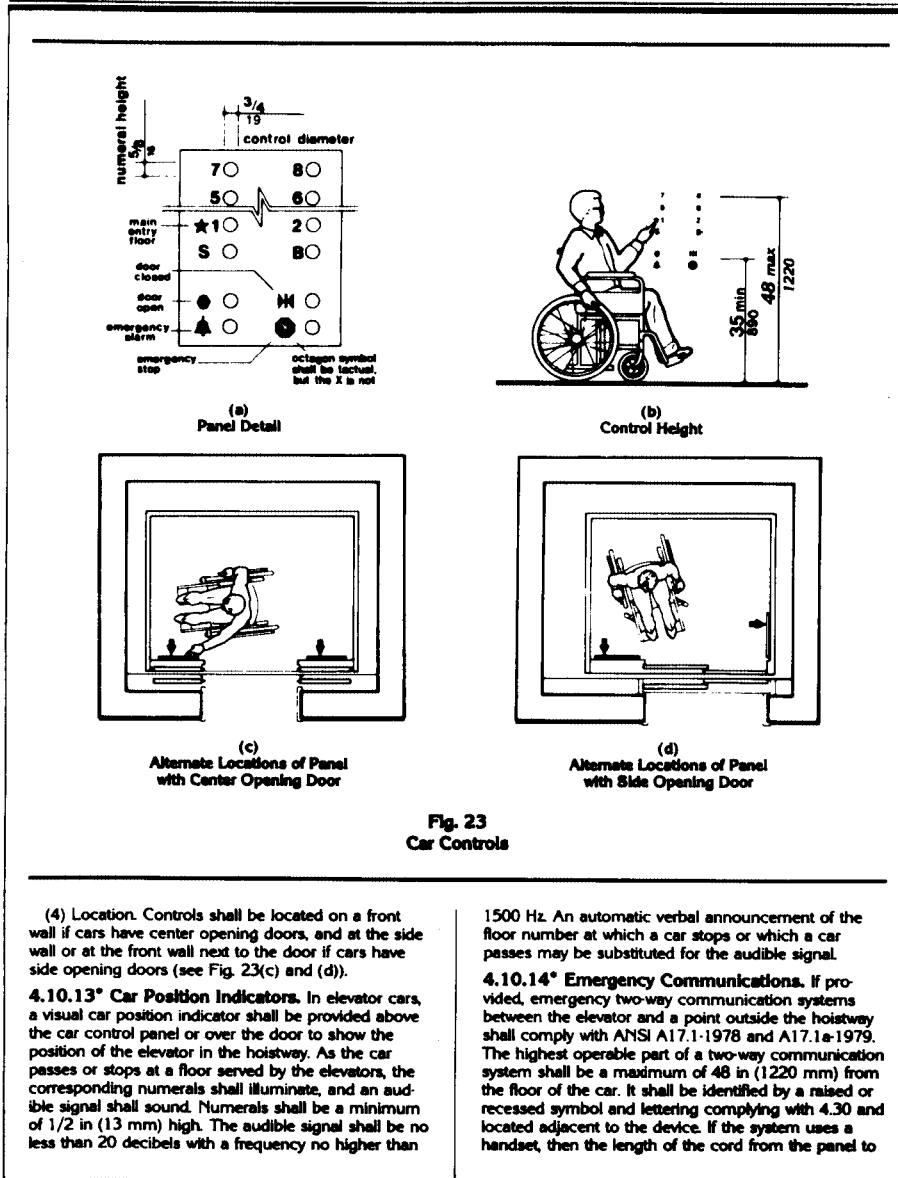
(b)

Fig. 22
Minimum Dimensions of Elevator Cars

designated by a raised star at the left of the floor designation (see Fig. 23(a)). All raised designations for control buttons shall be placed immediately to the left of the button to which they apply. Applied plates, permanently attached, are an acceptable means to provide raised control designations. Floor buttons shall be provided with visual indicators to show when each call is registered. The visual indicators shall be extinguished when each call is answered.

(3) Height. All floor buttons shall be no higher than 48 in (1220 mm), unless there is a substantial increase in cost, in which case the maximum mounting height may be increased to 54 in (1370 mm), above the floor. Emergency controls, including the emergency alarm and emergency stop, shall be grouped at the bottom of the panel and shall have their centerlines no less than 35 in (890 mm) above the floor (see Fig. 23(a) and (b)).

4.10 Elevators



4.13 Doors

the handset shall be at least 29 in (735 mm). If the system is located in a closed compartment, the compartment door hardware shall conform to 4.27, Controls and Operating Mechanisms. The emergency intercommunication system shall not require voice communication.

4.11* Platform Lifts.

4.11.1 Location. Platform lifts permitted by 4.1 shall comply with the requirements of 4.11.

4.11.2 Other Requirements. If platform lifts are used, they shall comply with 4.2.4, 4.5, 4.27, and the applicable safety regulations of administrative authorities having jurisdiction.

4.11.3 Entrance. If platform lifts are used, then they should facilitate unassisted entry and exit from the lift in compliance with 4.11.2.

4.12 Windows. (Reserved).

4.13 Doors.

4.13.1 General. Doors required to be accessible by 4.1 shall comply with the requirements of 4.13.

4.13.2 Revolving Doors and Turnstiles. Revolving doors or turnstiles shall not be the only means of passage at an accessible entrance or along an accessible route. An accessible gate or door shall be provided adjacent to the turnstile or revolving door and shall be so designed as to facilitate the same use pattern.

4.13.3 Gates. Gates, including ticket gates, shall meet all applicable specifications of 4.13.

4.13.4 Double-Leaf Doorways. If doorways have two independently operated door leaves, then at least one leaf shall meet the specifications in 4.13.5 and 4.13.6. That leaf shall be an active leaf.

4.13.5 Clear Width. Doorways shall have a minimum clear opening of 32 in (815 mm) with the door open 90 degrees, measured between the face of the door and the stop (see Fig. 24(a), (b), (c), and (d)). Openings more than 24 in (610 mm) in depth shall comply with 4.2.1 and 4.3.3 (see Fig. 24(e)).

EXCEPTION: Doors not requiring full user passage, such as shallow closets, may have the clear opening reduced to 20 in (510 mm) minimum.

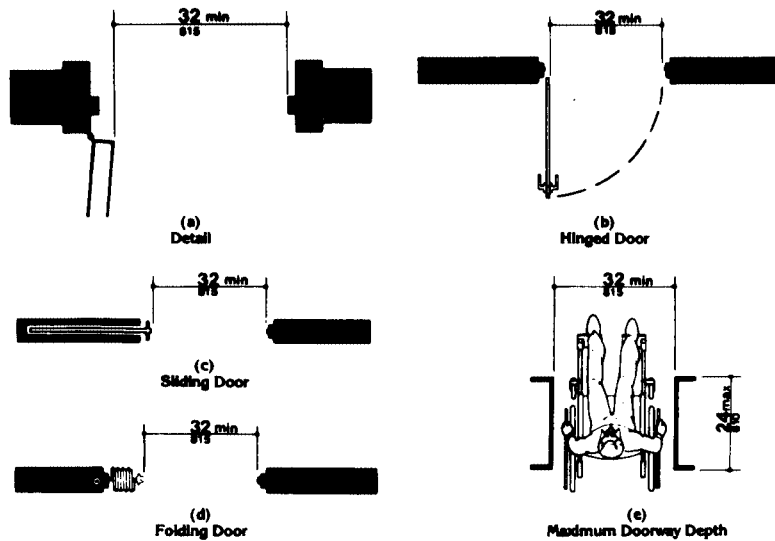
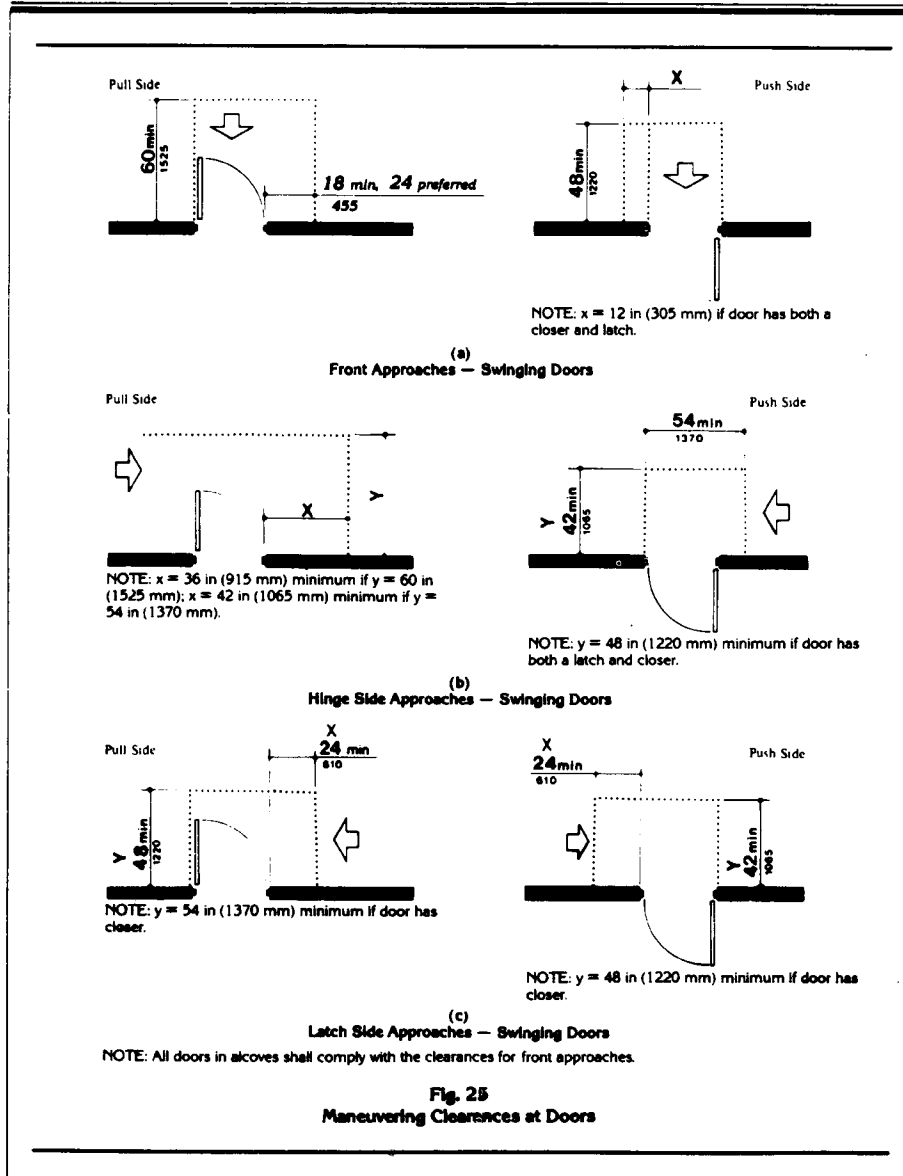
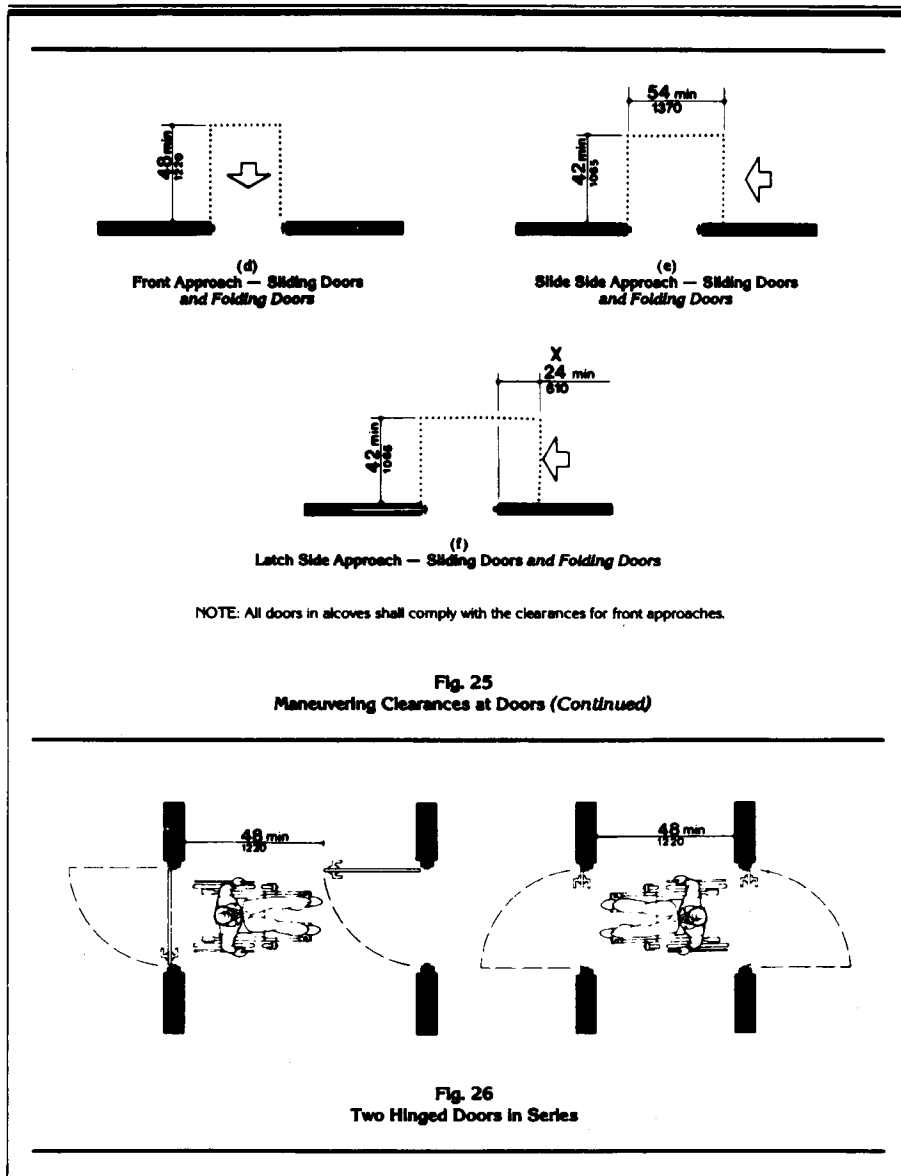


Fig. 24
Clear Doorway Width and Depth

4.13 Doors



4.13 Doors



4.13 Doors

4.13.6 Maneuvering Clearances at Doors.

Minimum maneuvering clearances at doors that are not automatic or power-assisted shall be as shown in Fig. 25. The floor or ground area within the required clearances shall be level and clear. Entry doors to acute care hospital bedrooms for in-patients shall be exempted from the requirement for space at the latch side of the door (see dimension "x" in Fig. 25) if the door is at least 44 in (1120 mm) wide.

4.13.7 Two Doors in Series. The minimum space between two hinged or pivoted doors in series shall be 48 in (1220 mm) plus the width of any door swinging into the space. Doors in series shall swing either in the same direction or away from the space between the doors (see Fig. 26).

4.13.8* Thresholds at Doorways. Thresholds at doorways shall not exceed 3/4 in (19 mm) in height for exterior sliding doors or 1/2 in (13 mm) for other types of doors. Raised thresholds and floor level changes at accessible doorways shall be beveled with a slope no greater than 1:2 (see 4.5.2).

4.13.9* Door Hardware. Handles, pulls, latches, locks, and other operating devices on accessible doors shall have a shape that is easy to grasp with one hand and does not require tight grasping, tight pinching, or twisting of the wrist to operate. Lever-operated mechanisms, push-type mechanisms, and U-shaped handles are acceptable designs. When sliding doors are fully open, operating hardware shall be exposed and usable from both sides. In dwelling units, only doors at accessible entrances to the unit itself shall comply with the requirements of this paragraph. Doors to hazardous areas shall have hardware complying with 4.29.3. *Mount no hardware required for accessible door passage higher than 48 in (1220 mm) above finished floor.*

4.13.10* Door Closers. If a door has a closer, then the sweep period of the closer shall be adjusted so that from an open position of 70 degrees, the door will take at least 3 seconds to move to a point 3 in (75 mm) from the latch, measured to the leading edge of the door.

4.13.11* Door Opening Force. The maximum force for pushing or pulling open a door shall be as follows:

- (1) Fire doors shall have the minimum opening force allowable by the appropriate administrative authority.
- (2) Other doors.
 - (a) exterior hinged doors: *(Reserved)*.
 - (b) interior hinged doors: 5 lbf (22.2N)
 - (c) sliding or folding doors: 5 lbf (22.2N)

These forces do not apply to the force required to retract latch bolts or disengage other devices that may hold the door in a closed position.

4.13.12* Automatic Doors and Power-Assisted Doors.

If an automatic door is used, then it shall comply with American National Standard for Power-Operated Doors, ANSI A156.10-1979. Slowly opening, low-powered, automatic doors shall be considered a type of custom design installation as described in paragraph 1.1.1 of ANSI A156.10-1979. Such doors shall not open to back check faster than 3 seconds and shall require no more than 15 lbf (66.6N) to stop door movement. If a power-assisted door is used, its door-opening force shall comply with 4.13.11 and its closing shall conform to the requirements in section 10 of ANSI A156.10-1979.

4.14 Entrances.

4.14.1 Minimum Number. *Entrances required to be accessible by 4.1* shall be part of an accessible route and shall comply with 4.3. Such entrances shall be connected by an accessible route to public transportation stops, to accessible parking and passenger loading zones, and to public streets or sidewalks if available (see 4.3.2(1)). They shall also be connected by an accessible route to all accessible spaces or elements within the building or facility.

4.14.2 Service Entrances. A service entrance shall not be the sole accessible entrance unless it is the only entrance to a building or facility (for example, in a factory or garage).

4.15 Drinking Fountains and Water Coolers.

4.15.1 Minimum Number. *Drinking fountains or water coolers required to be accessible by 4.1 shall comply with 4.15.*

4.15.2* Spout Height. Spouts shall be no higher than 36 in (915 mm), measured from the floor or ground surfaces to the spout outlet (see Fig. 27(a)).

4.15.3 Spout Location. The spouts of drinking fountains and water coolers shall be at the front of the unit and shall direct the water flow in a trajectory that is parallel or nearly parallel to the front of the unit. The spout shall provide a flow of water at least 4 in (100 mm) high so as to allow the insertion of a cup or glass under the flow of water.

4.15.4 Controls. Controls shall comply with 4.27.4. *Unit controls shall be front mounted or side mounted near the front edge.*

4.15.5 Clearances.

(1) Wall- and post-mounted cantilevered units shall have a clear knee space between the bottom of the apron and the floor or ground at least 27 in (685 mm) high, 30 in (760 mm) wide, and 17 in to 19 in (430 mm to 485 mm) deep (see Fig. 27(a) and (b)). Such units shall also have a minimum clear floor space 30 in by 48 in (760 mm by 1220 mm) to allow a person in a wheelchair to approach the unit facing forward.

4.16 Water Closets

(2) Free-standing or built-in units not having a clear space under them shall have a clear floor space at least 30 in by 48 in (760 mm by 1220 mm) that allows a person in a wheelchair to make a parallel approach to the unit (see Fig. 27(c) and (d)). This clear floor space shall comply with 4.2.4.

4.16 Water Closets.

4.16.1 General. Accessible water closets shall comply with 4.16. For water closets in accessible dwelling units, see 4.34.5.2.

4.16.2 Clear Floor Space. Clear floor space for water closets not in stalls shall comply with Fig. 28. Clear floor space may be arranged to allow either a left-handed or right-handed approach.

4.16.3 Height. The height of water closets shall be 17 in to 19 in (430 mm to 485 mm), measured to the top of the toilet seat (see Fig. 29(b)). Seats shall not be sprung to return to a lifted position.

4.16.4 Grab Bars. Grab bars for water closets not located in stalls shall comply with Fig. 29 and 4.26.

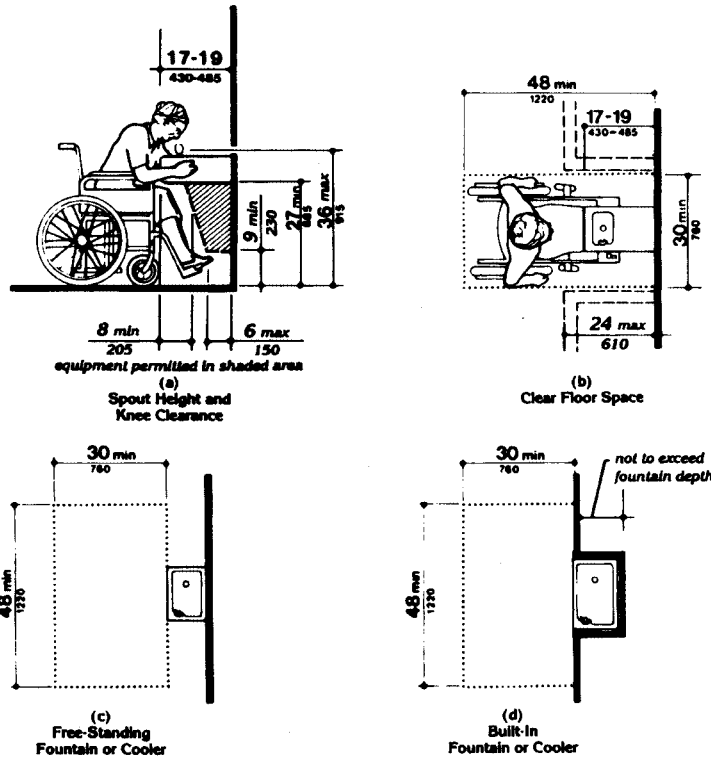
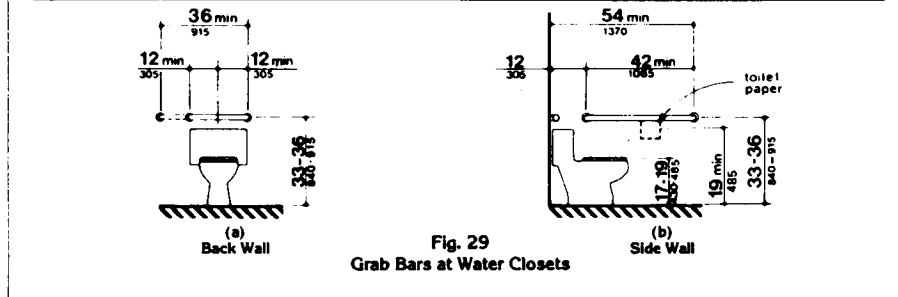
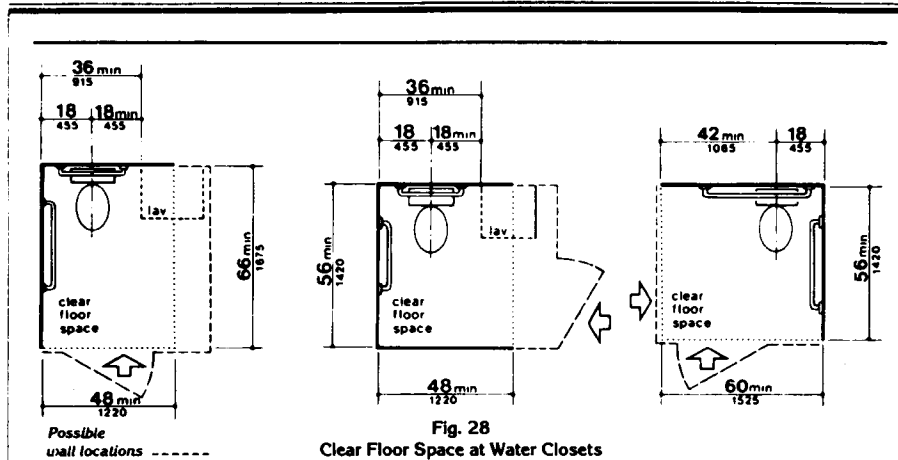


Fig. 27
Drinking Fountains and Water Coolers

4.16 Water Closets



4.16.5* Flush Controls. Flush controls shall be hand operated or automatic and shall comply with 4.27.4. Controls for flush valves shall be mounted on the wide side of toilet areas no more than 44 in (1120 mm) above the floor.

4.16.6 Dispensers. Toilet paper dispensers shall be installed within reach, as shown in Fig. 29(b). *Dispensers that control delivery, or that do not permit continuous paper flow, shall not be used.*

4.17 Toilet Stalls.

4.17.1 Location. Accessible toilet stalls shall be on an accessible route and shall meet the requirements of 4.17.

4.17.2 Water Closets. Water closets in accessible stalls shall comply with 4.16.

4.17.3 Size and Arrangement. The size and

arrangement of toilet stalls shall comply with Fig. 30(a). Toilet stalls with a minimum depth of 56 in (1420 mm) (see Fig. 30(a)) shall have wall-mounted water closets. If the depth of toilet stalls is increased at least 3 in (75 mm), then a floor-mounted water closet may be used. Arrangements shown for stalls may be reversed to allow either a left- or right-hand approach.

EXCEPTION: In instances of alteration work where provision of a standard stall (Fig. 30(a)) is structurally impracticable or where plumbing code requirements prevent combining existing stalls to provide space, an alternate stall (Fig. 30(b)) may be provided in lieu of the standard stall.

4.17.4 Toe Clearances. In standard stalls, the front partition and at least one side partition shall provide a toe clearance of at least 9 in (230 mm) above the floor. If the depth of the stall is greater than 60 in (1525 mm), then the toe clearance is not required.

4.17 Toilet Stalls

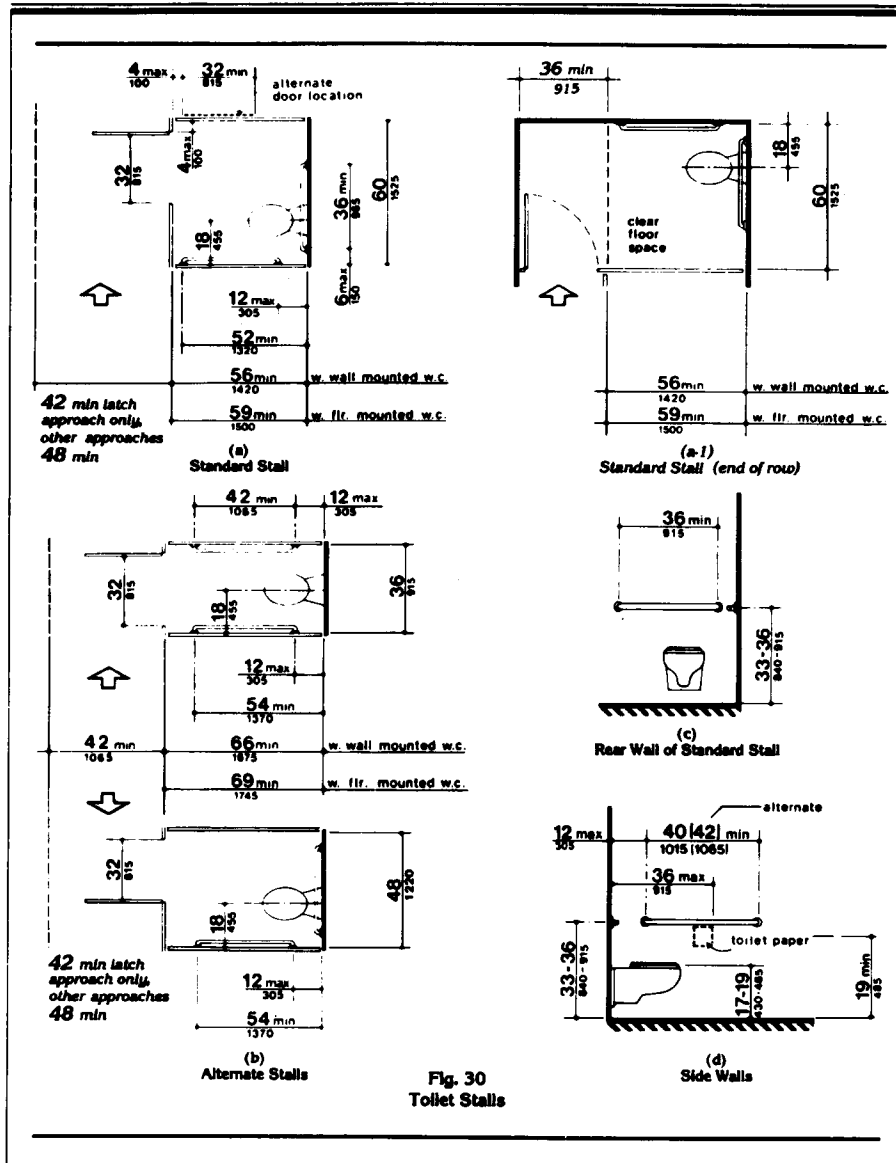


Fig. 30 Toilet Stalls

4.17 Toilet Stalls

4.17.5* Doors. Toilet stall doors shall comply with 4.13. *If toilet stall approach is from the latch side of the stall door, clearance between the door side of the stall and any obstruction may be reduced to a minimum of 42 in (1065 mm).*

4.17.6 Grab Bars. Grab bars complying with the length and positioning shown in Fig. 30(a), (b), (c), and (d) shall be provided. Grab bars may be mounted with any desired method as long as they have a gripping surface at the locations shown and do not obstruct the required clear floor area. Grab bars shall comply with 4.26.

4.18 Urinals.

4.18.1 General. Accessible urinals shall comply with 4.18.

4.18.2 Height. Urinals shall be stall-type or wall-hung with an elongated rim at a maximum of 17 in (430 mm) above the floor.

4.18.3 Clear Floor Space. A clear floor space 30 in by 48 in (760 mm by 1220 mm) shall be provided in front of urinals to allow forward approach. This clear space shall adjoin or overlap an accessible route and shall comply with 4.2.4. *Urinal shields that do not extend beyond the front edge of the urinal rim may be provided with 29 in (735 mm) clearance between them.*

4.18.4 Flush Controls. Flush controls shall be hand operated or automatic, and shall comply with 4.27.4, and shall be mounted no more than 44 in (1120 mm) above the floor.

4.19 Lavatories and Mirrors.

4.19.1 General. The requirements of 4.19 shall apply to lavatory fixtures, vanities, and built-in lavatories.

4.19.2 Height and Clearances. Lavatories shall be mounted with the rim or counter surface no higher than 34 in (865 mm) above the finished floor. Provide a clearance of at least 29 in (735 mm) from the floor to the bottom of the apron. Knee and toe clearance shall comply with Fig. 31.

4.19.3 Clear Floor Space. A clear floor space 30 in by 48 in (760 mm by 1220 mm) complying with 4.2.4 shall be provided in front of a lavatory to allow forward approach. Such clear floor space shall adjoin or overlap an accessible route and shall extend a maximum of 19 in (485 mm) underneath the lavatory (see Fig. 32).

4.19.4 Exposed Pipes and Surfaces. Hot water and drain pipes under lavatories shall be insulated or otherwise covered. There shall be no sharp or abrasive surfaces under lavatories.

4.19.5 Faucets. Faucets shall comply with 4.27.4. Lever-operated, push-type, and electronically controlled mechanisms are examples of acceptable designs. Self-closing valves are allowed if the faucet remains open for at least 10 seconds.

4.19.6* Mirrors. Mirrors shall be mounted with the bottom edge of the reflecting surface no higher than 40 in (1015 mm) from the floor (see Fig. 31).

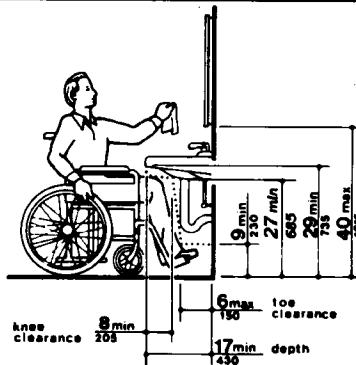
4.20 Bathtubs.

4.20.1 General. Accessible bathtubs shall comply with 4.20. For bathtubs in accessible dwelling units, see 4.34.5.4.

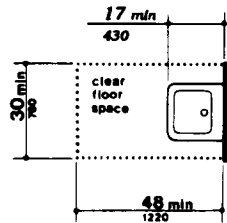
4.20.2 Floor Space. Clear floor space in front of bathtubs shall be as shown in Fig. 33.

4.20.3 Seat. An in-tub seat or a seat at the head end of the tub shall be provided as shown in Fig. 33 and 34. The structural strength of seats and their attachments shall comply with 4.26.3. Seats shall be mounted securely and shall not slip during use.

4.20.4 Grab Bars. Grab bars complying with 4.26 shall be provided as shown in Fig. 33 and 34.

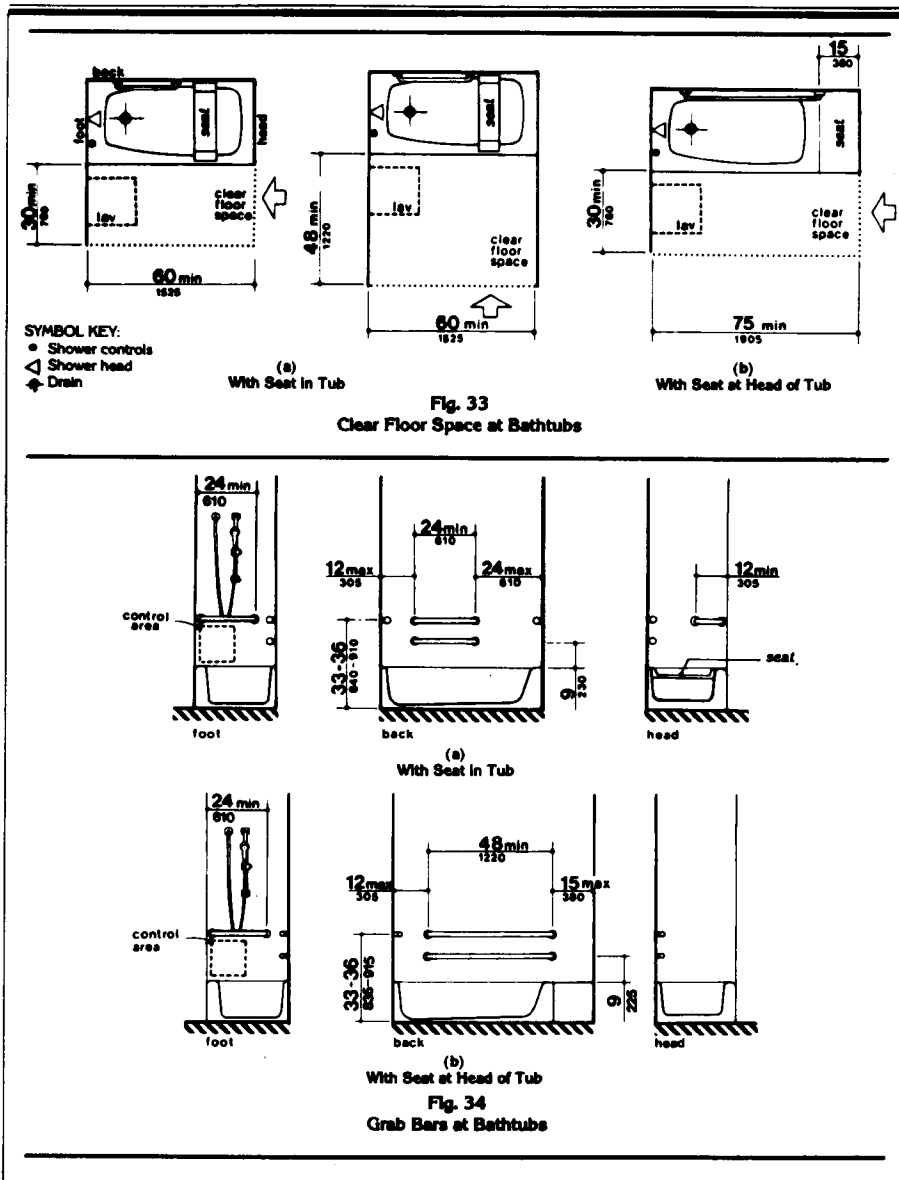


**Fig. 31
Lavatory Clearances**



**Fig. 32
Clear Floor Space at Lavatories**

4.20 Bathtubs



4.20 Bathtubs

4.20.5 Controls. Faucets and other controls complying with 4.27.4 shall be located as shown in Fig. 34.

4.20.6 Shower Unit. A shower spray unit with a hose at least 60 in (1525 mm) long that can be used as a fixed shower head or as a hand-held shower shall be provided.

4.20.7 Bathtub Enclosures. If provided, enclosures for bathtubs shall not obstruct controls or transfer from wheelchairs onto bathtub seats or into tubs. Enclosures on bathtubs shall not have tracks mounted on their rims.

4.21 Shower Stalls.

4.21.1* General. Accessible shower stalls shall comply with 4.21. For shower stalls in accessible dwelling units, see 4.34.5.5.

4.21.2 Size and Clearances. Shower stall size and clear floor space shall comply with Fig. 35(a) or (b). The shower stall in Fig. 35(a) shall be 36 in by 36 in (915 mm by 915 mm). The shower stall in Fig. 35(b) will fit into the space required for a bathtub.

4.21.3 Seat. A seat shall be provided in shower stalls 36 in by 36 in (915 mm by 915 mm) and shall be as shown in Fig. 36. The seat shall be mounted 17 in to 19 in (430 mm to 485 mm) from the bathroom floor and shall extend the full depth of the stall. The seat shall be on the wall opposite the controls. The structural strength of seats and their attachments shall comply with 4.26.3.

4.21.4 Grab Bars. Grab bars complying with 4.26 shall be provided as shown in Fig. 37.

4.21.5 Controls. Faucets and other controls complying with 4.27.4 shall be located as shown in Fig. 37. In shower stalls 36 in by 36 in (915 mm by 915 mm), all controls, faucets, and the shower unit shall be mounted on the side wall opposite the seat.

4.21.6 Shower Unit. A shower spray unit with a hose at least 60 in (1525 mm) long that can be used as a fixed shower head or as a hand-held shower shall be provided.

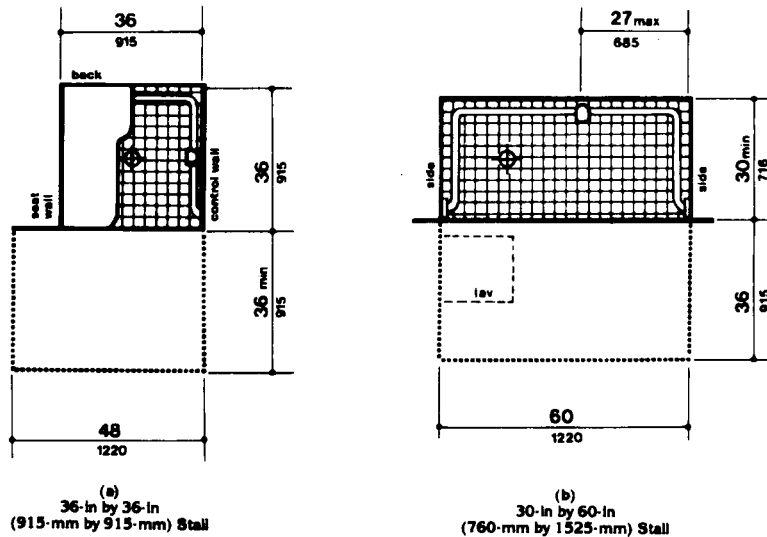
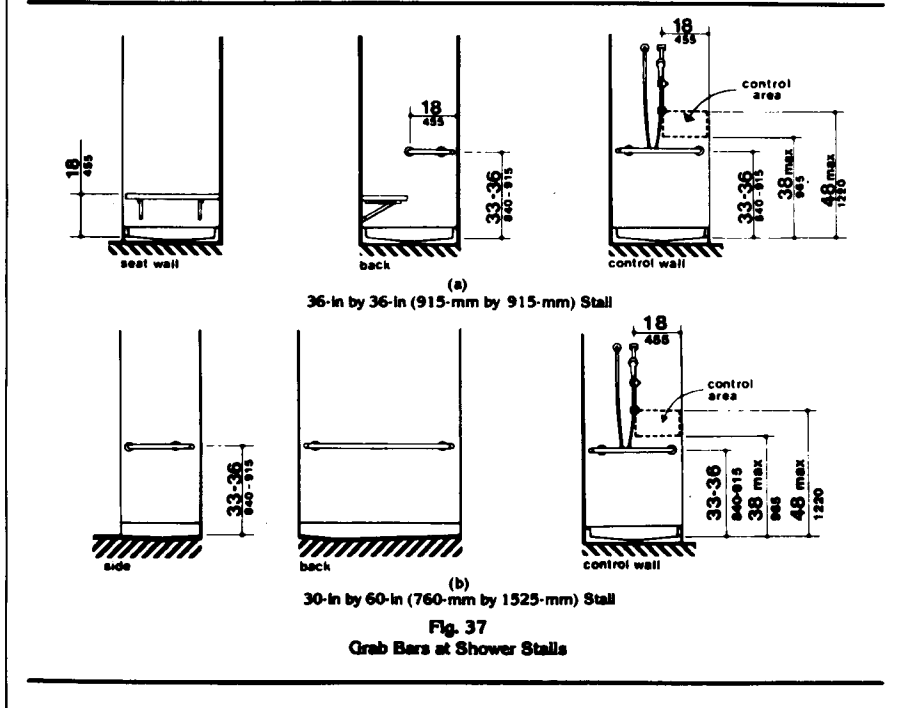
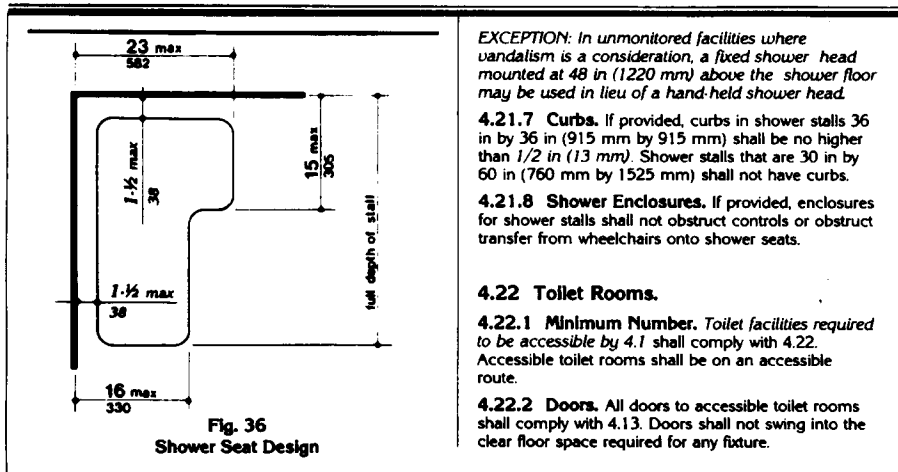


Fig. 35
Shower Size and Clearances

4.22 Toilet Rooms



4.22 Toilet Rooms

4.22.3 Clear Floor Space. The accessible fixtures and controls required in 4.22.4, 4.22.5, 4.22.6, and 4.22.7 shall be on an accessible route. An unobstructed turning space complying with 4.2.3 shall be provided within an accessible toilet room. The clear floor space at fixtures and controls, the accessible route, and the turning space may overlap.

EXCEPTION: In toilet rooms with only one water closet and one lavatory, a clear floor space of 30 in by 60 in (815 mm by 1525 mm) may be used in lieu of the unobstructed turning space.

4.22.4 Water Closets. If toilet stalls are provided, then at least one shall comply with 4.17; its water closet shall comply with 4.16. If water closets are not in stalls, then at least one shall comply with 4.16.

4.22.5 Urinals. If urinals are provided, then at least one shall comply with 4.18.

4.22.6 Lavatories and Mirrors. If lavatories and mirrors are provided, then at least one of each shall comply with 4.19.

4.22.7 Controls and Dispensers. If controls, dispensers, receptacles, or other equipment is provided, then at least one of each shall be on an accessible route and shall comply with 4.27.

4.23 Bathrooms, Bathing Facilities, and Shower Rooms.

4.23.1 Minimum Number. Bathrooms, bathing facilities, or shower rooms required to be accessible by 4.1 shall comply with 4.23 and shall be on an accessible route. For adaptable bathrooms in accessible dwelling units, see 4.34.5.

4.23.2 Doors. Doors to accessible bathrooms shall comply with 4.13. Doors shall not swing into the floor space required for any fixture.

4.23.3 Clear Floor Space. The accessible fixtures and controls required in 4.23.4, 4.23.5, 4.23.6, 4.23.7, 4.23.8, and 4.23.9 shall be on an accessible route. An unobstructed turning space complying with 4.2.3 shall be provided within an accessible bathroom. The clear floor spaces at fixtures and controls, the accessible route, and the turning space may overlap.

EXCEPTION: In bathrooms with only one water closet, one lavatory, and one bathtub or shower, a clear floor space of 30 in by 60 in (760 mm by 1525 mm) may be used in lieu of the unobstructed turning space.

4.23.4 Water Closets. If toilet stalls are provided, then at least one shall comply with 4.17; its water closet shall comply with 4.16. If water closets are not in stalls, then at least one shall comply with 4.16.

4.23.5 Urinals. If urinals are provided, then at least one shall comply with 4.18.

4.23.6 Lavatories and Mirrors. If lavatories and mirrors are provided, then at least one of each shall comply with 4.19.

4.23.7 Controls and Dispensers. If controls, dispensers, receptacles, or other equipment is provided, then at least one of each shall be on an accessible route and shall comply with 4.27.

4.23.8 Bathing and Shower Facilities. If tubs or showers are provided, then at least one accessible tub that complies with 4.20 or at least one accessible shower that complies with 4.21 shall be provided.

4.23.9* Medicine Cabinets. If medicine cabinets are provided, at least one shall be located with a usable shelf no higher than 44 in (1120 mm) above the floor space. The floor space shall comply with 4.2.4.

4.24 Sinks.

4.24.1 General. Sinks required to be accessible by 4.1 shall comply with 4.24. Sinks in kitchens of accessible dwelling units shall comply with 4.34.6.5.

4.24.2 Height. Sinks shall be mounted with the counter or rim no higher than 34 in (865 mm) from the floor.

4.24.3 Knee Clearance. Knee clearance that is at least 27 in (685 mm) high, 30 in (760 mm) wide, and 19 in (485 mm) deep shall be provided underneath sinks.

4.24.4 Depth. Each sink shall be a maximum of 6-1/2 in (165 mm) deep.

4.24.5 Clear Floor Space. A clear floor space at least 30 in by 48 in (760 mm by 1220 mm) complying with 4.2.4 shall be provided in front of a sink to allow forward approach. The clear floor space shall be on an accessible route and shall extend a maximum of 19 in (485 mm) underneath the sink (see Fig. 32).

4.24.6 Exposed Pipes and Surfaces. Hot water and drain pipes exposed under sinks shall be insulated or otherwise covered. There shall be no sharp or abrasive surfaces under sinks.

4.24.7 Faucets. Faucets shall comply with 4.27.4. Lever-operated, push-type, touch-type, or electronically controlled mechanisms are acceptable designs.

4.25 Storage.

4.25.1 General. Fixed storage facilities such as cabinets, shelves, closets, and drawers required to be accessible by 4.1 shall comply with 4.25.

4.25.2 Clear Floor Space. A clear floor space at least 30 in by 48 in (760 mm by 1220 mm) complying with 4.2.4 that allows either a forward or parallel approach by a person using a wheelchair shall be provided at accessible storage facilities.

4.25.3 Height. Accessible storage spaces shall be within at least one of the reach ranges specified in 4.2.5 and 4.2.6. Clothes rods shall be a maximum of 54 in (1370 mm) from the floor (see Fig. 38).

4.25.4 Hardware. Hardware for accessible storage facilities shall comply with 4.27.4. Touch latches and U-shaped pulls are acceptable.

4.28 Alarms

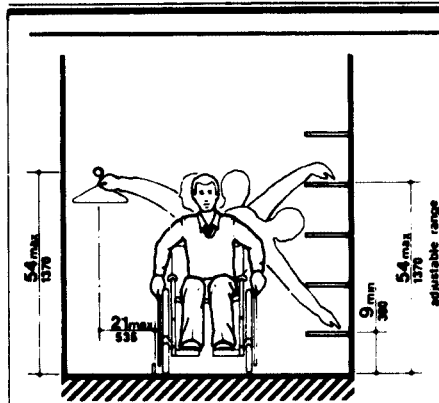


Fig. 38
Storage Shelves and Closets

4.26 Handrails, Grab Bars, and Tub and Shower Seats.

4.26.1* General. All handrails, grab bars, and tub and shower seats required to be accessible by 4.1, 4.8, or 4.9 shall comply with 4.26.

4.26.2* Size and Spacing of Grab Bars and Handrails. The diameter or width of the gripping surfaces of a handrail or grab bar shall be 1-1/4 in (32 mm) to 1-1/2 in (38 mm), or the shape shall provide an equivalent gripping surface. If handrails or grab bars are mounted adjacent to a wall, the space between the wall and the grab bar shall be 1-1/2 in (38 mm) (see Fig. 39(a), (b), and (c)). Handrails may be located in a recess if the recess is a maximum of 3 in (75 mm) deep and extends at least 18 in (455 mm) above the top of the rail (see Fig. 39(d)).

4.26.3 Structural Strength. The structural strength of grab bars, tub and shower seats, fasteners, and mounting devices shall meet the following specification:

(1) Bending stress in a grab bar or seat induced by the maximum bending moment from the application of 250 lbf (1112N) shall be less than the allowable stress for the material of the grab bar or seat.

(2) Shear stress induced in a grab bar or seat by the application of 250 lbf (1112N) shall be less than the allowable shear stress for the material of the grab bar or seat. If the connection between the grab bar or seat and its mounting bracket or other support is considered to be fully restrained, then direct and torsional shear stresses shall be totaled for the combined shear stress, which shall not exceed the allowable shear stress.

(3) Shear force induced in a fastener or mounting device from the application of 250 lbf (1112N) shall be less than the allowable lateral load of either the fastener or mounting device or the supporting structure, whichever is the smaller allowable load.

(4) Tensile force induced in a fastener by a direct tension force of 250 lbf (1112N) plus the maximum moment from the application of 250 lbf (1112N) shall be less than the allowable withdrawal and the supporting structure.

(5) Grab bars shall not rotate within their fittings.

4.26.4 Eliminating Hazards. A handrail or grab bar and any wall or other surface adjacent to it shall be free of any sharp or abrasive elements. Edges shall have a minimum radius of 1/8 in (3.2 mm).

4.27 Controls and Operating Mechanisms.

4.27.1 General. Controls and operating mechanisms required to be accessible by 4.1 shall comply with 4.27.

4.27.2 Clear Floor Space. Clear floor space complying with 4.2.4 that allows a forward or a parallel approach by a person using a wheelchair shall be provided at controls, dispensers, receptacles, and other operable equipment.

4.27.3* Height. The highest operable part of all controls, dispensers, receptacles, and other operable equipment shall be placed within at least one of the reach ranges specified in 4.2.5 and 4.2.6. Except where the use of special equipment dictates otherwise, electrical and communications system receptacles on walls shall be mounted no less than 15 in (380 mm) above the floor.

4.27.4 Operation. Controls and operating mechanisms shall be operable with one hand and shall not require tight grasping, pinching, or twisting of the wrist. The force required to activate controls shall be no greater than 5 lbf (22.2 N).

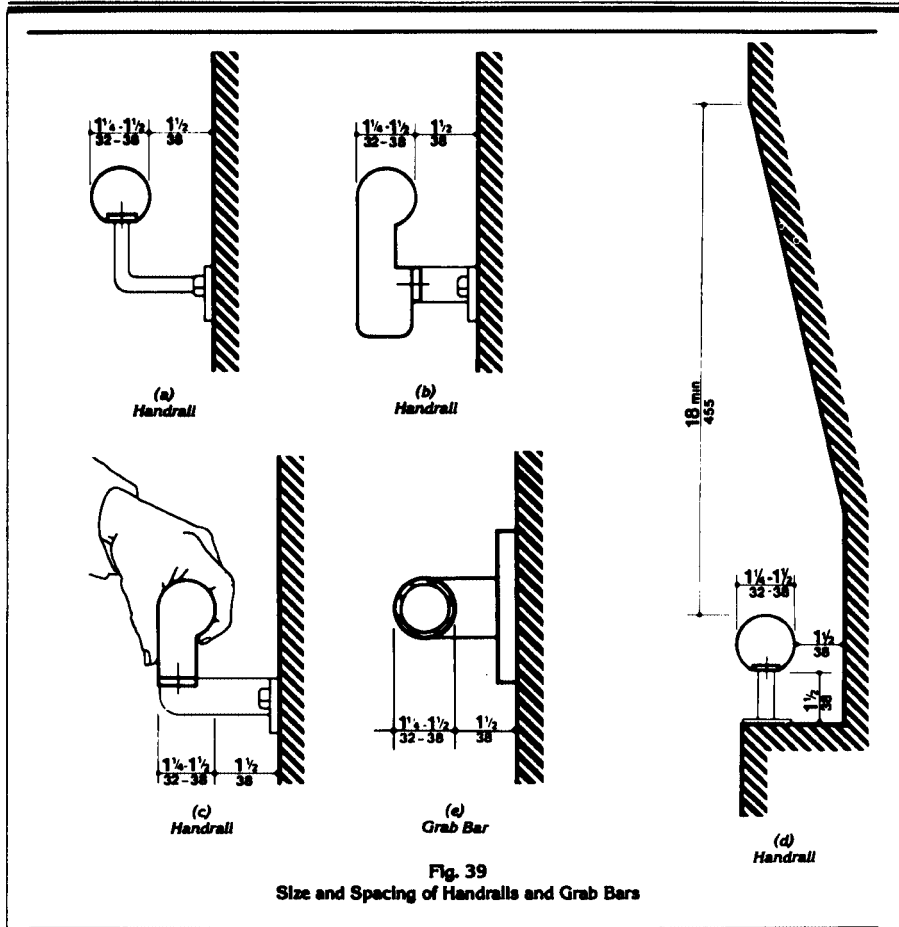
4.28 Alarms.

4.28.1 General. Alarm systems required to be accessible by 4.1 shall comply with 4.28.

4.28.2* Audible Alarms. If provided, audible emergency alarms shall produce a sound that exceeds the prevailing equivalent sound level in the room or space by at least 15 decibels or exceeds any maximum sound level with a duration of 30 seconds by 5 decibels, whichever is louder. Sound levels for alarm signals shall not exceed 120 decibels.

4.28.3* Visual Alarms. If provided, electrically powered internally illuminated emergency exit signs shall flash as a visual emergency alarm in conjunction with audible emergency alarms. The flashing frequency of visual alarm devices shall be less than 5 Hz. If such alarms use electricity from the building as a power source, then they shall be installed on the same system as the audible emergency alarms.

4.28 Alarms



EXCEPTIONS:

(1) Visual alarm devices that are mounted adjacent to emergency exit signs may be used in lieu of flashing exit signs.

(2) Specialized systems utilizing advanced technology may be substituted for the visual systems specified above if equivalent protection is afforded handicapped users of the building or facility.

4.28.4* Auxiliary Alarms. Accessible sleeping accommodations shall have a visual alarm connected

to the building emergency alarm system or shall have a standard 110-volt electrical receptacle into which such an alarm could be connected. Instructions for use of the auxiliary alarm or connection shall be provided.

4.29 Tactile Warnings.

4.29.1 General. Tactile warnings required to be accessible by 4.1 shall comply with 4.29.

4.29.2* Tactile Warnings on Walking Surfaces. (Reserved).

4.31 Telephones

4.29.3* Tactile Warnings on Doors to Hazardous Areas. Doors that lead to areas that might prove dangerous to a blind person (for example, doors to loading platforms, boiler rooms, stages, and the like) shall be made identifiable to the touch by a textured surface on the door handle, knob, pull, or other operating hardware. This textured surface may be made by knurling or roughing or by a material applied to the contact surface. Such textured surfaces shall not be provided for emergency exit doors or any doors other than those to hazardous areas.

4.29.4 Tactile Warnings at Stairs. *(Reserved).*

4.29.5* Tactile Warnings at Hazardous Vehicular Areas. *(Reserved).*

4.29.6* Tactile Warnings at Reflecting Pools. *(Reserved).*

4.29.7* Standardization. Textured surfaces for tactile door warnings shall be standard within a building, facility, site, or complex of buildings.

4.30 Signage.

4.30.1* General. *Signage shall comply with 4.30 as specified in 4.1.*

4.30.2* Character Proportion. Letters and numbers on signs shall have a width-to-height ratio between 3:5 and 1:1 and a stroke width-to-height ratio between 1:5 and 1:10.

4.30.3* Color Contrast. Characters and symbols shall contrast with their background -- either light characters on a dark background or dark characters on a light background.

4.30.4* Raised Characters or Symbols. Letters and numbers on signs shall be raised 1/32 in (0.8 mm) minimum and shall be sans serif characters. Raised characters or symbols shall be at least 5/8 in (16 mm) high, but no higher than 2 in (50 mm). Symbols or pictographs on signs shall be raised 1/32 in (0.8 mm) minimum.

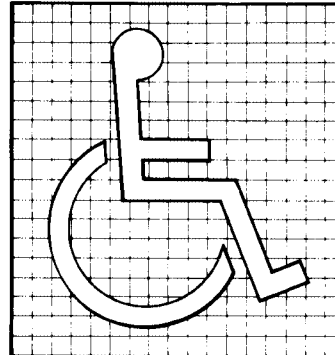
4.30.5 Symbols of Accessibility. Accessible facilities required to be identified by 4.1, shall use the international symbol of accessibility. The symbol shall be displayed as shown in Fig. 43.

4.30.6 Mounting Location and Height. Interior signage shall be located alongside the door on the latch side and shall be mounted at a height of between 54 in and 66 in (1370 mm and 1675 mm) above the finished floor.

4.31 Telephones.

4.31.1 General. Public telephones required to be accessible by 4.1 shall comply with 4.31.

4.31.2 Clear Floor or Ground Space. A clear floor or ground space at least 30 in by 48 in (760 mm by 1220 mm) that allows either a forward or parallel approach by a person using a wheelchair shall be provided at telephones (see Fig. 44). The clear floor or



(a)
Proportions



(b)
Display Conditions

Fig. 43
International Symbol of Accessibility

ground space shall comply with 4.2.4. Bases, enclosures, and fixed seats shall not impede approaches to telephones by people who use wheelchairs.

4.31.3* Mounting Height. The highest operable part of the telephone shall be within the reach ranges specified in 4.2.5 or 4.2.6.

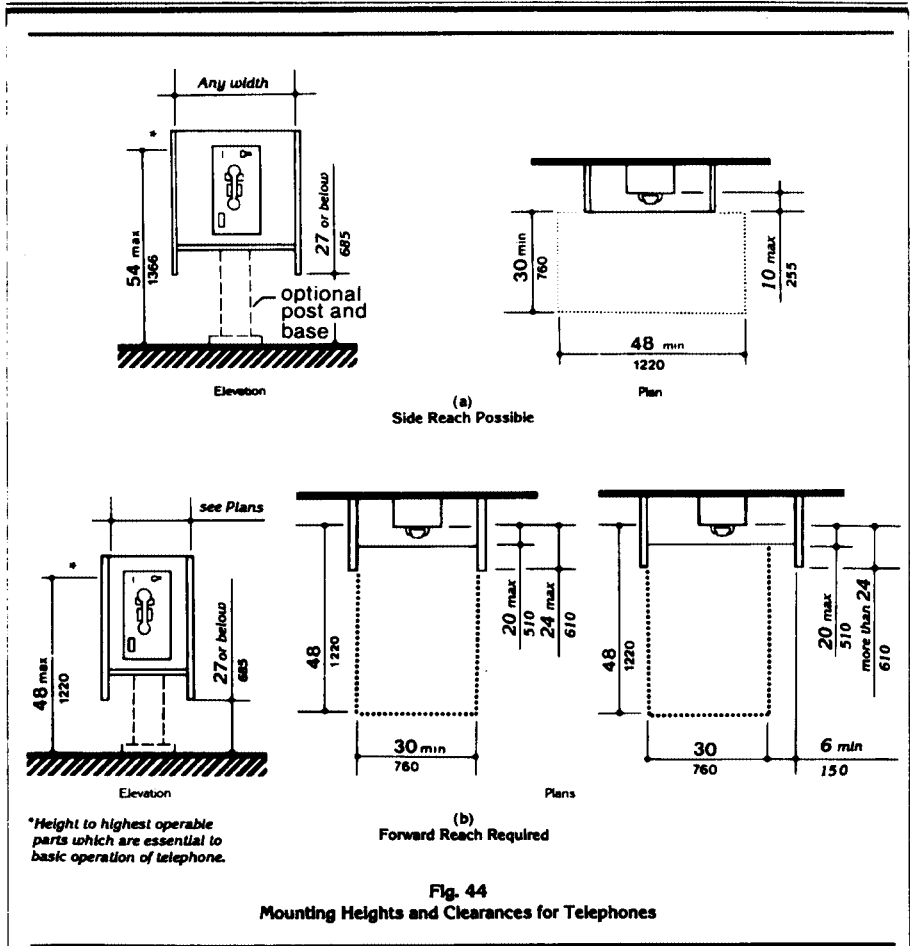
4.31.4 Protruding Objects. Telephones shall comply with 4.4.

4.31.5* Equipment for Hearing Impaired People. Telephones shall be equipped with a receiver that generates a magnetic field in the area of the receiver cap. Volume controls shall be provided in accordance with 4.1.2.

4.31.6 Controls. Telephones shall have pushbutton controls where service for such equipment is available.

4.31.7 Telephone Books. Telephone books, if provided, shall be located in a position that complies with the reach ranges specified in 4.2.5 and 4.2.6.

4.31 Telephones



4.31.8 Cord Length. The cord from the telephone to the handset shall be at least 29 in (735 mm) long.

4.32 Seating, Tables, and Work Surfaces.

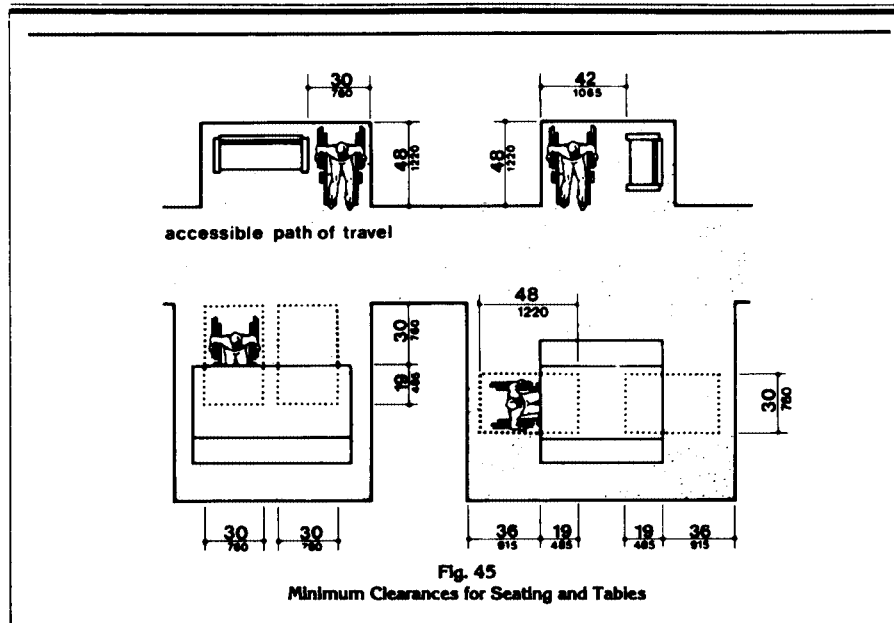
4.32.1 Minimum Number. Fixed or built-in seating, tables, or work surfaces required to be accessible by 4.1 shall comply with 4.32.

4.32.2 Seating. If seating spaces for people in wheelchairs are provided at tables, counters, or work

surfaces, clear floor space complying with 4.2.4 shall be provided. Such clear floor space shall not overlap knee space by more than 19 in (485 mm) (see Fig. 45).

4.32.3 Knee Clearances. If seating for people in wheelchairs is provided at tables, counters, and work surfaces, knee spaces at least 27 in (685 mm) high, 30 in (760 mm) wide, and 19 in (485 mm) deep shall be provided (see Fig. 45).

4.34 Dwelling Units



4.32.4* Height of Work Surfaces. The tops of tables and work surfaces shall be from 28 in to 34 in (710 mm to 865 mm) from the floor or ground.

4.33 Assembly Areas.

4.33.1 Minimum Number. Assembly and associated areas required to be accessible by 4.1 shall comply with 4.33.

4.33.2* Size of Wheelchair Locations. Each wheelchair location shall provide minimum clear ground or floor spaces as shown in Fig. 46.

4.33.3* Placement of Wheelchair Locations. Wheelchair areas shall be an integral part of any fixed seating plan and shall be dispersed throughout the seating area. They shall adjoin an accessible route that also serves as a means of egress in case of emergency and shall be located to provide lines of sight comparable to those for all viewing areas.

EXCEPTION: Accessible viewing positions may be clustered for bleachers, balconies, and other areas having sight lines that require slopes of greater than 5 percent. Equivalent accessible viewing positions may be located on levels having accessible egress.

4.33.4 Surfaces. The ground or floor at wheelchair locations shall be level and shall comply with 4.5.

4.33.5 Access to Performing Areas. An accessible route shall connect wheelchair seating locations with performing areas, including stages, arena floors, dressing rooms, locker rooms, and other spaces used by performers.

4.33.6* Placement of Listening Systems. If the listening system provided serves individual fixed seats, then such seats shall be located within a 50 ft (15 m) viewing distance of the stage or playing area and shall have a complete view of the stage or playing area.

4.33.7* Types of Listening Systems. Audio loops and radio frequency systems are two acceptable types of listening systems.

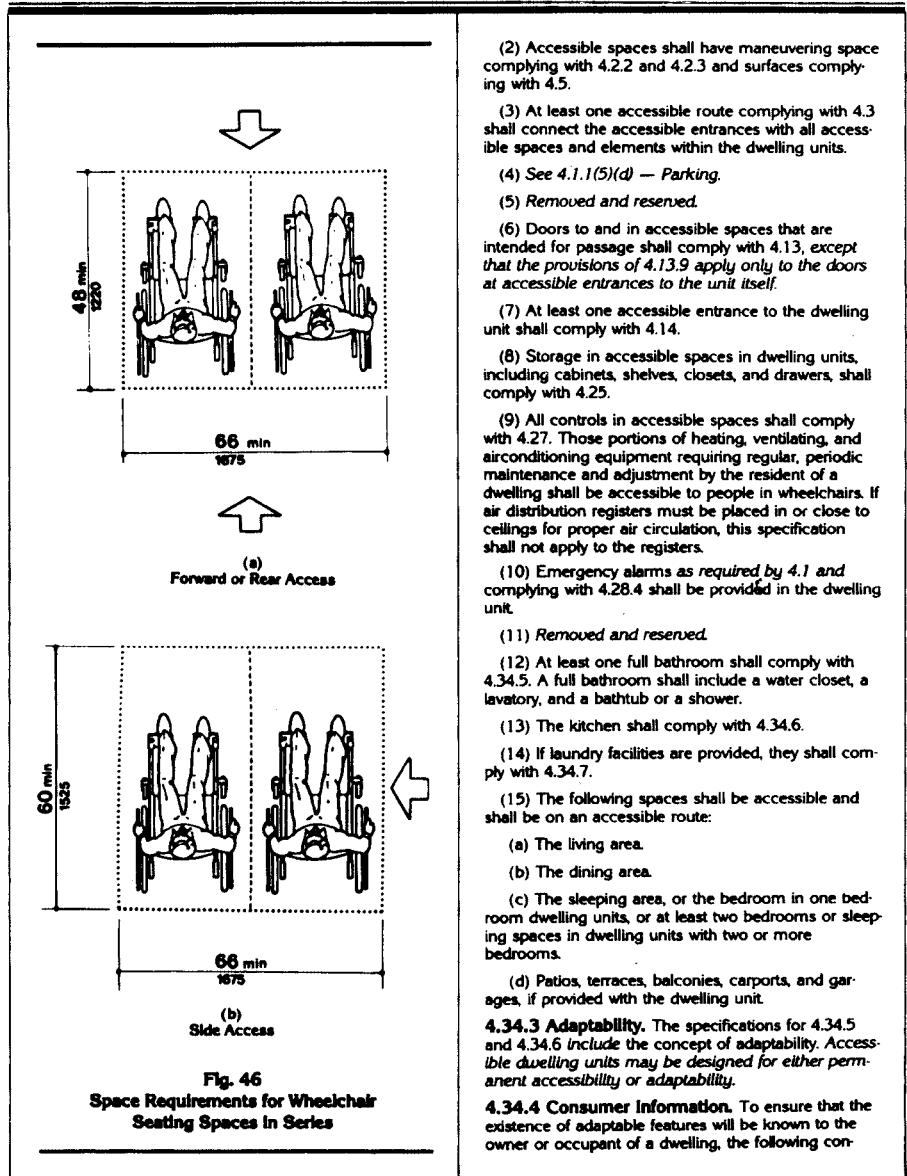
4.34 Dwelling Units.

4.34.1 General. The requirements of 4.34 apply to dwelling units required to be accessible by 4.1.

4.34.2* Minimum Requirements. An accessible dwelling unit shall be on an accessible route. An accessible dwelling unit shall have the following accessible elements and spaces as a minimum:

(1) Common spaces and facilities serving individual accessible dwelling units (for example, entry walks, trash disposal facilities, and mail boxes) shall comply with 4.2 through 4.33.

4.34 Dwelling Units



- (2) Accessible spaces shall have maneuvering space complying with 4.2.2 and 4.2.3 and surfaces complying with 4.5.
 - (3) At least one accessible route complying with 4.3 shall connect the accessible entrances with all accessible spaces and elements within the dwelling units.
 - (4) See 4.1.1(5)(d) — Parking.
 - (5) *Removed and reserved.*
 - (6) Doors to and in accessible spaces that are intended for passage shall comply with 4.13, except that the provisions of 4.13.9 apply only to the doors at accessible entrances to the unit itself.
 - (7) At least one accessible entrance to the dwelling unit shall comply with 4.14.
 - (8) Storage in accessible spaces in dwelling units, including cabinets, shelves, closets, and drawers, shall comply with 4.25.
 - (9) All controls in accessible spaces shall comply with 4.27. Those portions of heating, ventilating, and airconditioning equipment requiring regular, periodic maintenance and adjustment by the resident of a dwelling shall be accessible to people in wheelchairs. If air distribution registers must be placed in or close to ceilings for proper air circulation, this specification shall not apply to the registers.
 - (10) Emergency alarms as required by 4.1 and complying with 4.28.4 shall be provided in the dwelling unit.
 - (11) *Removed and reserved.*
 - (12) At least one full bathroom shall comply with 4.34.5. A full bathroom shall include a water closet, a lavatory, and a bathtub or a shower.
 - (13) The kitchen shall comply with 4.34.6.
 - (14) If laundry facilities are provided, they shall comply with 4.34.7.
 - (15) The following spaces shall be accessible and shall be on an accessible route:
 - (a) The living area.
 - (b) The dining area.
 - (c) The sleeping area, or the bedroom in one bedroom dwelling units, or at least two bedrooms or sleeping spaces in dwelling units with two or more bedrooms.
 - (d) Patios, terraces, balconies, carports, and garages, if provided with the dwelling unit.
- 4.34.3 Adaptability.** The specifications for 4.34.5 and 4.34.6 include the concept of adaptability. Accessible dwelling units may be designed for either permanent accessibility or adaptability.
- 4.34.4 Consumer Information.** To ensure that the existence of adaptable features will be known to the owner or occupant of a dwelling, the following con-

4.34 Dwelling Units

sumer information shall be provided in each *adaptable* dwelling unit available for *occupancy*:

(1) Notification of the alternate heights available for the kitchen counter and sink, and the existence of removable cabinets and bases, if provided, under counters, sinks, and lavatories.

(2) Notification of the provisions for the installation of grab bars at toilets, bathtubs, and showers.

(3) Notification that the dwelling unit is equipped to have a visual emergency alarm installed.

(4) Identification of the location where information and instructions are available for changing the height of counters, removing cabinets and bases, installing a visual emergency alarm system, and installing grab bars.

(5) Notification that the dwelling unit has been designed in accordance with this *Uniform Federal Accessibility Standards*.

In addition, the *parties who will be responsible for making adaptations* shall be provided with the following information:

(1) Instructions for adjusting or replacing kitchen counter and sink heights and for removing cabinets.

(2) A scale drawing showing methods and locations for the installation of grab bars.

(3) A scale drawing showing the location of adjustable or replaceable counter areas and removable cabinets.

(4) Identification of the location of any equipment and parts required for adjusting or replacing counter tops, cabinets, and sinks.

(5) Instructions for installing a visual emergency alarm system, if the dwelling unit is equipped for such an installation.

4.34.5* Bathrooms. *Accessible or adaptable* bathrooms shall be on an accessible route and shall comply with the requirements of 4.34.5.

4.34.5.1 Doors. Doors shall not swing into the clear floor space required for any fixture.

4.34.5.2 Water Closets.

(1) Clear floor space at the water closet shall be as shown in Fig. 47(a). The water closet may be located with the clear area at either the right or left side of the toilet.

(2) The height of the water closet shall be at least 15 in (380 mm), and no more than 19 in (485 mm), measured to the top of the toilet seat.

(3) Structural reinforcement or other provisions that will allow installation of grab bars shall be provided in the locations shown in Fig. 47(b). If provided, grab bars shall be installed as shown in Fig. 29 and shall comply with 4.26.

(4) The toilet paper dispenser shall be installed within reach as shown in Fig. 47(b).

4.34.5.3 Lavatory, Mirrors, and Medicine Cabinets.

(1) The lavatory and mirrors shall comply with 4.22.6.

(2) If a cabinet is provided under the lavatory in adaptable bathrooms, then it shall be removable to provide the clearances specified in 4.22.6.

(3) If a medicine cabinet is provided above the lavatory, then the bottom of the medicine cabinet shall be located with a usable shelf no higher than 44 in (1120 mm) above the floor.

4.34.5.4 Bathtubs. If a bathtub is provided, then it shall have the following features:

(1) Floor space. Clear floor space at bathtubs shall be as shown in Fig. 33.

(2) Seat. An in-tub seat or a seat at the head end of the tub shall be provided as shown in Fig. 33 and 34. The structural strength of seats and their attachments shall comply with 4.26.3. Seats shall be mounted securely and shall not slip during use.

(3) Grab bars. Structural reinforcement or other provisions that will allow installation of grab bars shall be provided in the locations shown in Fig. 48. If provided, grab bars shall be installed as shown in Fig. 34 and shall comply with 4.26.

(4) Controls. Faucets and other controls shall be located as shown in Fig. 34 and shall comply with 4.27.4.

(5) Shower unit. A shower spray unit with a hose at least 60 in (1525 mm) long that can be used as a fixed shower head or as a hand-held shower shall be provided.

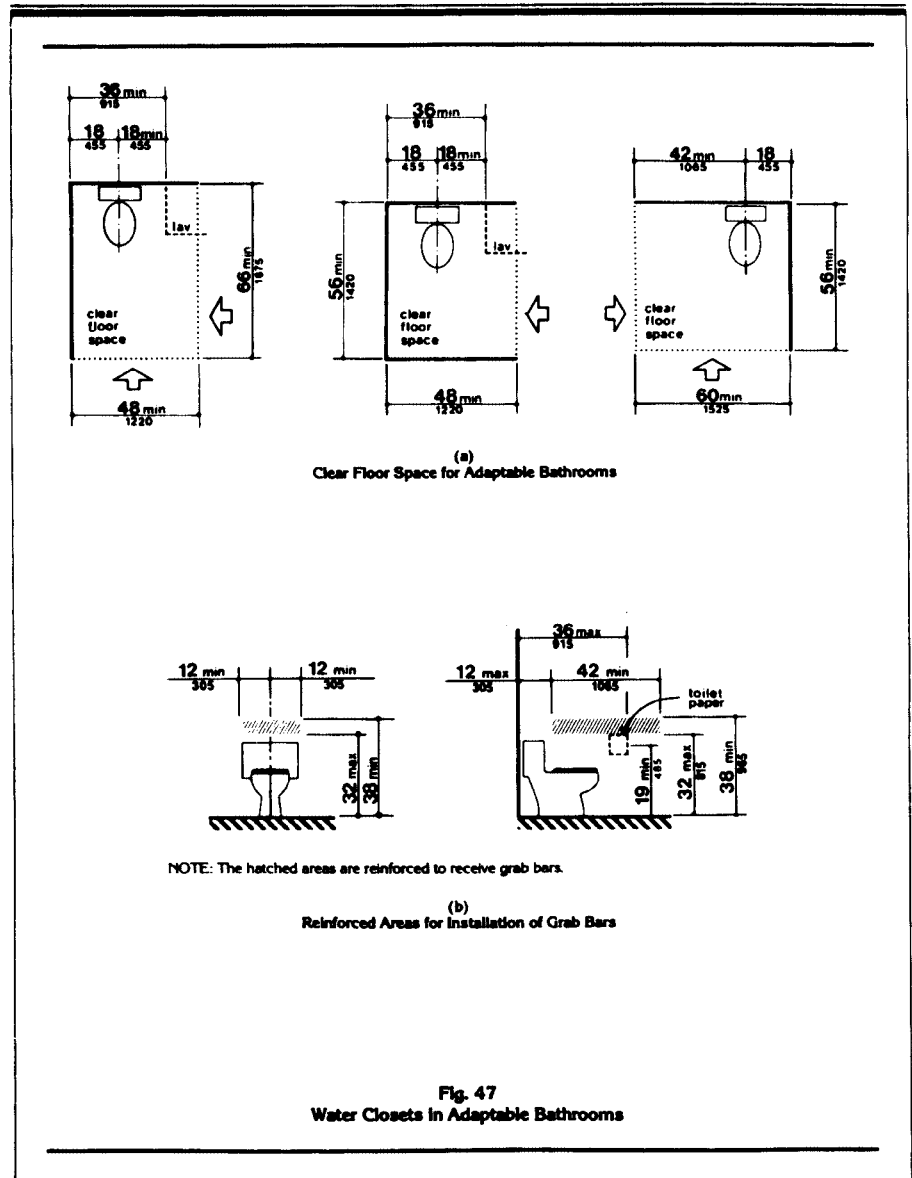
4.34.5.5 Showers. If a shower is provided, it shall have the following features:

(1) Size and clearances. Shower stall size and clear floor space shall comply with either Fig. 35(a) or (b). The shower stall in Fig. 35(a) shall be 36 in by 36 in (915 mm by 915 mm). The shower stall in Fig. 35(b) will fit into the same space as a standard 60 in (1525 mm) long bathtub.

(2) Seat. A seat shall be provided in the shower stall in Fig. 35(a) as shown in Fig. 36. The seat shall be 17 in to 19 in (430 mm to 485 mm) high measured from the bathroom floor and shall extend the full depth of the stall. The seat shall be on the wall opposite the controls. The structural strength of seats and their attachments shall comply with 4.26.3. Seats shall be mounted securely and shall not slip during use.

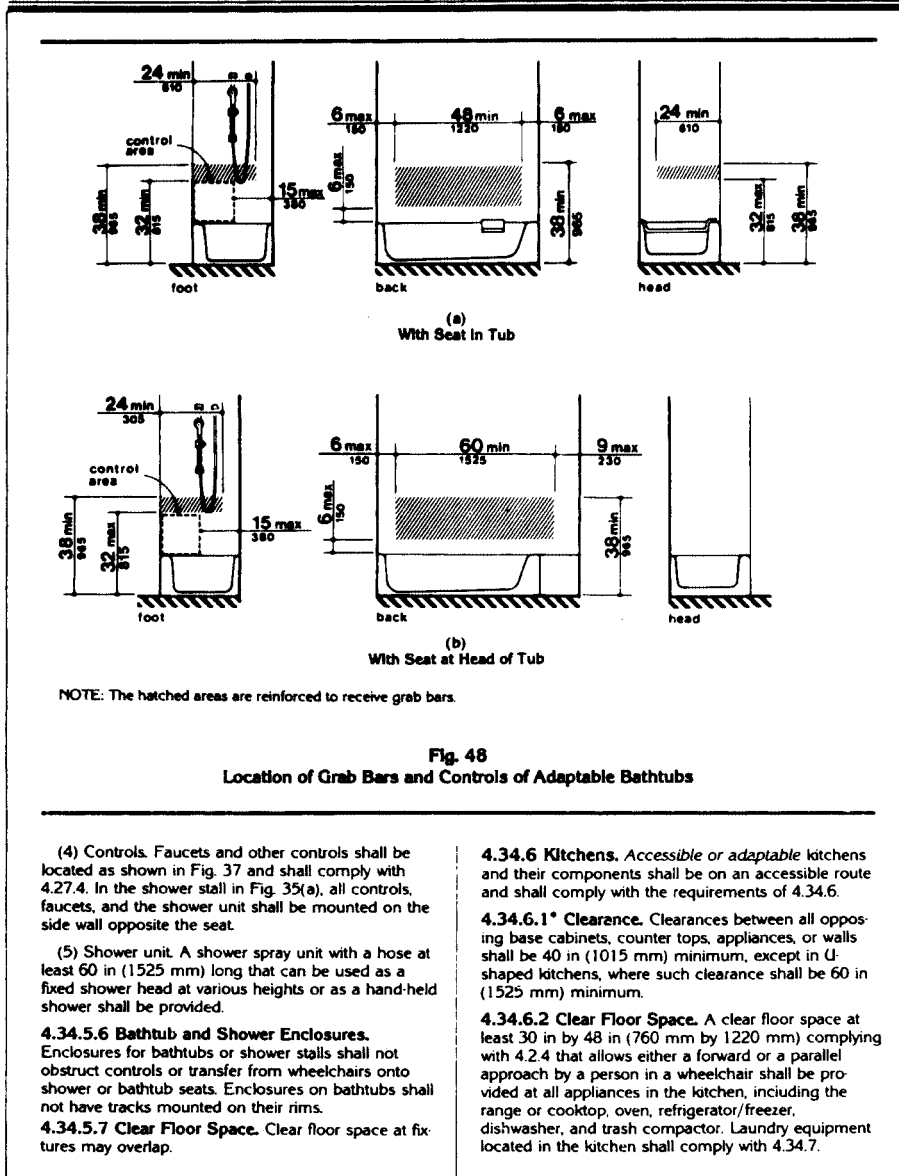
(3) Grab bars. Structural reinforcement or other provisions that will allow installation of grab bars shall be provided in the locations shown in Fig. 49. If provided, grab bars shall be installed as shown in Fig. 37 and shall comply with 4.26.

4.34 Dwelling Units

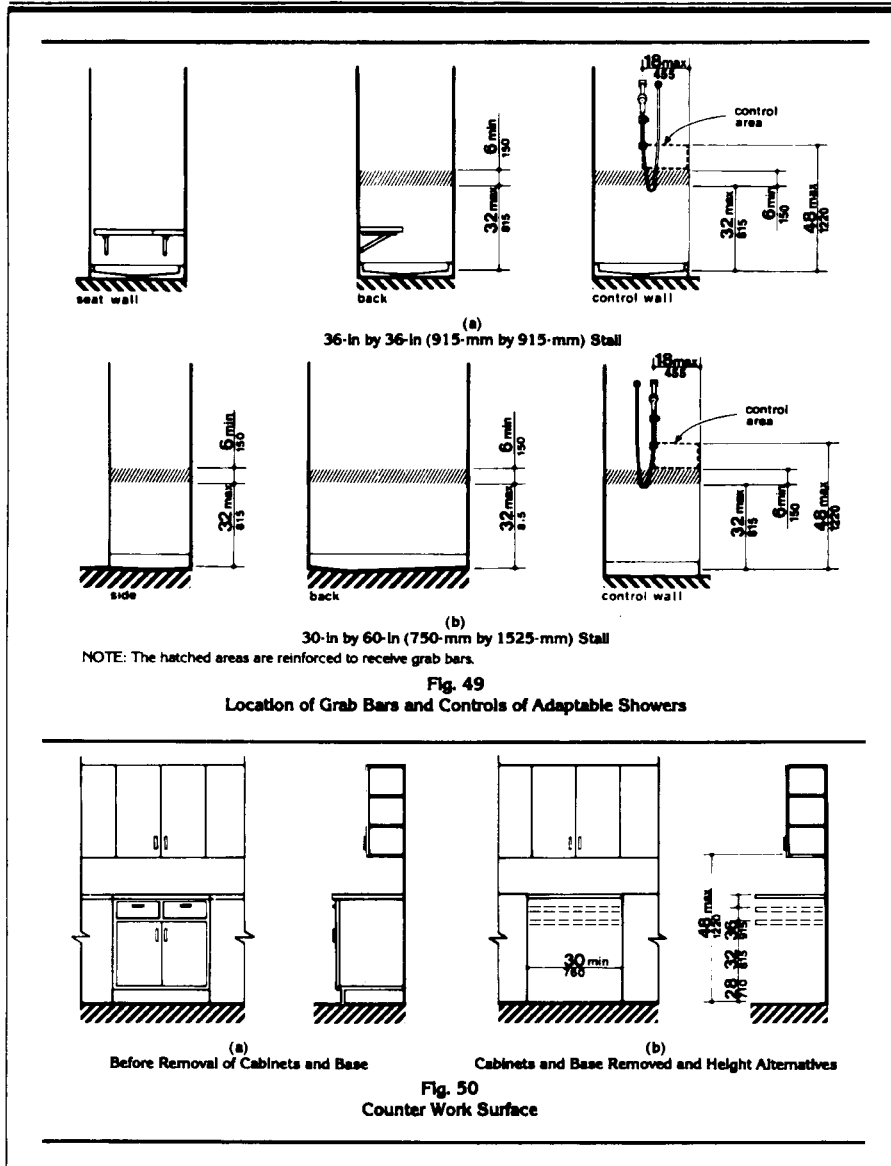


52

4.34 Dwelling Units



4.34 Dwelling Units



54

4.34 Dwelling Units

4.34.6.3 Controls. All controls in kitchens shall comply with 4.27.

4.34.6.4 Work Surfaces. At least one 30 in (760 mm) section of counter shall provide a work surface that complies with the following requirements (see Fig. 50):

(1) The counter shall be mounted at a maximum height of 34 in (865 mm) above the floor, measured from the floor to the top of the counter surface, or shall be adjustable or replaceable as a unit to provide alternative heights of 28 in, 32 in, and 36 in (710 mm, 815 mm, and 915 mm), measured from the top of the counter surface.

(2) Base cabinets, if provided, shall be removable under the full 30 in (760 mm) minimum frontage of the counter. The finished floor shall extend under the counter to the wall.

(3) Counter thickness and supporting structure shall be 2 in (50 mm) maximum over the required clear area.

(4) A clear floor space 30 in by 48 in (760 mm by 1220 mm) shall allow a forward approach to the counter. Nineteen inches (485 mm) maximum of the clear floor space may extend underneath the counter. The knee space shall have a minimum clear width of 30 in (760 mm) and a minimum clear depth of 19 in (485 mm).

(5) There shall be no sharp or abrasive surfaces under such counters.

4.34.6.5* Sink. The sink and surrounding counter shall comply with the following requirements (see Fig. 51):

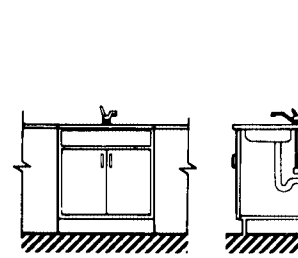
(1) The sink and surrounding counter shall be mounted at a maximum height of 34 in (865 mm) above the floor, measured from the floor to the top of the counter surface, or shall be adjustable or replaceable as a unit to provide alternative heights of 28 in, 32 in, and 36 in (710 mm, 815 mm, and 915 mm), measured from the floor to the top of the counter surface or sink rim. The total width of sink and counter area shall be 30 in (760 mm).

(2) Rough-in plumbing shall be located to accept connections of supply and drain pipes for sinks mounted at the height of 28 in (710 mm).

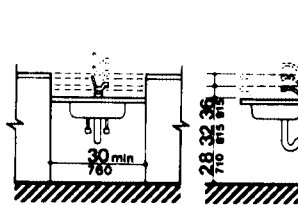
(3) The depth of a sink bowl shall be no greater than 6-1/2 in (165 mm). Only one bowl of double- or triple-bowl sinks needs to meet this requirement.

(4) Faucets shall comply with 4.27.4. Lever-operated or push-type mechanisms are two acceptable designs.

(5) Base cabinets, if provided, shall be removable under the full 30 in (760 mm) minimum frontage of the sink and surrounding counter. The finished flooring shall extend under the counter to the wall.



(a)
Before Removal of Cabinets and Base



(b)
Cabinets and Base Removed
and Height Alternatives

Fig. 51
Kitchen Sink

(6) Counter thickness and supporting structure shall be 2 in (50 mm) maximum over the required clear space.

(7) A clear floor space 30 in by 48 in (760 mm by 1220 mm) shall allow forward approach to the sink. Nineteen inches (485 mm) maximum of the clear floor space may extend underneath the sink. The knee space shall have a clear width of 30 in (760 mm) and a clear depth of 19 in (485 mm).

(8) There shall be no sharp or abrasive surfaces under sinks. Hot water and drain pipes under sinks shall be insulated or otherwise covered.

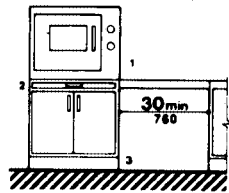
4.34.6.6* Ranges and Cooktops. Ranges and cooktops shall comply with 4.34.6.2 and 4.34.6.3. If ovens or cooktops have knee spaces underneath, then they shall be insulated or otherwise protected on the exposed contact surfaces to prevent burns, abrasions, or electrical shock. The clear floor space may overlap the knee space, if provided, by 19 in (485 mm) maximum. The location of controls for ranges and cooktops shall not require reaching across burners.

4.34 Dwelling Units

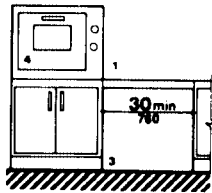
4.34.6.7* Ovens. Ovens shall comply with 4.34.6.2 and 4.34.6.3. Ovens shall be of the self-cleaning type or be located adjacent to an adjustable height counter with knee space below (see Fig. 52). For side-opening ovens, the door latch side shall be next to the open counter space, and there shall be a pull-out shelf under the oven extending the full width of the oven and pulling out not less than 10 in (255 mm) when fully extended. Ovens shall have controls on front panels; they may be located on either side of the door.

4.34.6.8* Refrigerator/Freezers. Refrigerator/freezers shall comply with 4.34.6.3. *Provision shall be made for refrigerators which are:*

- (1) Of the vertical side-by-side refrigerator/freezer type: or
- (2) Of the over-and-under type and meet the following requirements:
 - (a) Have at least 50 percent of the freezer space below 54 in (1370 mm) above the floor.



(a) Side-Hinged Door



(b) Bottom-Hinged Door

- SYMBOL KEY:**
- 1. Countertop or wall-mounted oven.
 - 2. Pull-out board preferred with side-opening door.
 - 3. Clear open space.
 - 4. Bottom-hinged door.

Fig. 52
Ovens without Self-Cleaning Feature

(b) Have 100 percent of the refrigerator space and controls below 54 in (1370 mm).
Freezers with less than 100 percent of the storage volume within the limits specified in 4.2.5 or 4.2.6 shall be the self-defrosting type.

4.34.6.9 Dishwashers. Dishwashers shall comply with 4.34.6.2 and 4.34.6.3. Dishwashers shall have all rack space accessible from the front of the machine for loading and unloading dishes.

4.34.6.10* Kitchen Storage. Cabinets, drawers, and shelf areas shall comply with 4.2.5 and shall have the following features:

- (1) Maximum height shall be 48 in (1220 mm) for at least one shelf of all cabinets and storage shelves mounted above work counters (see Fig. 50).
- (2) Door pulls or handles for wall cabinets shall be mounted as close to the bottom of cabinet doors as possible. Door pulls or handles for base cabinets shall be mounted as close to the top of cabinet doors as possible.

4.34.7 Laundry Facilities. If laundry equipment is provided within individual accessible dwelling units, or if separate laundry facilities serve one or more accessible dwelling units, then they shall meet the requirements of 4.34.7.1 through 4.34.7.3.

4.34.7.1 Location. Laundry facilities and laundry equipment shall be on an accessible route.

4.34.7.2 Washing Machines and Clothes Dryers. Washing machines and clothes dryers in common use laundry rooms shall be front loading.

4.34.7.3 Controls. Laundry equipment shall comply with 4.27.

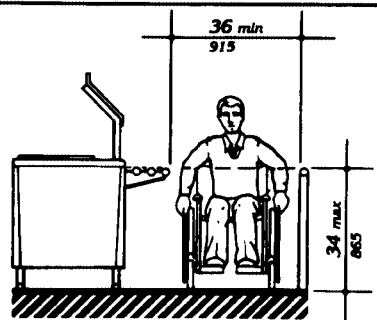


Fig. 53
Food Service Lines

7.0 Mercantile

5. RESTAURANTS AND CAFETERIAS.

5.1 General. In addition to the requirements of 4.1 to 4.33, the design of at least 5 percent of all fixed seating or tables in a restaurant or cafeteria shall comply with 4.32. Access aisles between tables shall comply with 4.3. Where practical, accessible tables should be distributed throughout the space or facility. In restaurants or cafeterias where there are mezzanine levels, loggias, or raised platforms, accessibility to all such spaces is not required providing that the same services and decorative character are provided in spaces located on accessible routes.

5.2 Food Service Lines. Food service lines shall have a minimum clear width of 36 in (915 mm), with a preferred clear width of 42 in (1065 mm) where passage of stopped wheelchairs by pedestrians is desired. Tray slides shall be mounted no higher than 34 in (865 mm) above the floor. If self-service shelves are provided, a reasonable portion must be within the ranges shown in Fig. 53.

5.3 Tableware Areas. Install tableware, dishware, condiment, food and beverage display shelves, and dispensing devices in compliance with 4.2 (see Fig. 54).

5.4 Vending Machines. Install vending machines in compliance with 4.27.

6. HEALTH CARE.

6.1 General. In addition to the requirements of 4.1 to 4.33, Health Care buildings and facilities shall comply with 6.

6.2 Entrances. At least one accessible entrance that complies with 4.14 shall be protected from the

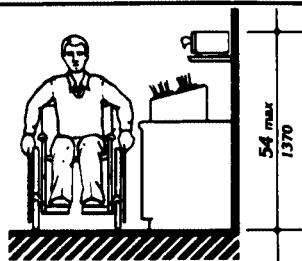


Fig. 54
Tableware Areas

weather by canopy or roof overhang. Such entrances shall incorporate a passenger loading zone that complies with 4.6.5 (see 4.13.6).

6.3 Patient Bedrooms. Provide accessible patient bedrooms in compliance with 4. Accessible patient bedrooms shall comply with the following:

(1) Each bedroom shall have a turning space that complies with 4.2.3, and preferably that is located near the entrance.

(2) Each one-bed room shall have a minimum clear floor space of 36 in (915 mm) along each side of the bed, and 42 in (1065 mm) between the foot of the bed and the wall.

(3) Each two-bed room shall have a minimum clear floor space of 42 in (1065 mm), preferably 48 in (1220 mm), between the foot of the bed and the wall; 36 in (915 mm) between the side of the bed and the wall; and 48 in (1220 mm) between beds.

(4) Each four-bed room shall have a minimum clear floor space of 48 in (1220 mm) from the foot of the bed to the foot of the opposing bed; 36 in (915 mm) between the side of the bed and the wall; and 48 in (1220 mm) between beds.

(5) Each bedroom shall have a door that complies with 4.13.

6.4 Patient Toilet Rooms. Provide each patient bedroom that is required to be accessible with an accessible toilet room that complies with 4.22 or 4.23.

7. MERCANTILE

7.1 General. In addition to the requirements of 4.1 to 4.33, the design of all areas used for business transactions with the public shall comply with 7.

7.2 Service Counters. Where service counters exceeding 36 in (915 mm) in height are provided for standing sales or distribution of goods to the public, an auxiliary counter or a portion of the main counter shall be provided with a maximum height of between 28 in to 34 in (710 mm to 865 mm) above the floor in compliance with 4.32.4.

7.3 Check-Out Aisles. At least one accessible check-out aisle shall be provided in buildings or facilities with check-out aisles. Clear aisle width shall comply with 4.2.1 and maximum adjoining counter height shall not exceed 36 in (915 mm) above the floor.

7.4 Security Bollards. Any device used to prevent the removal of shopping carts from store premises shall not prevent access or egress to those in wheelchairs. An alternate entry that is equally convenient to that provided for the ambulatory population is acceptable.

8.0 Libraries

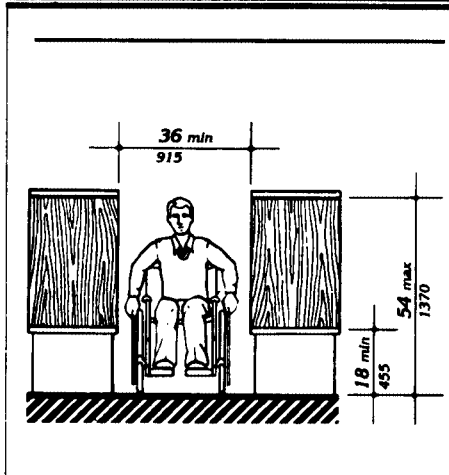


Fig. 55
Card Catalog

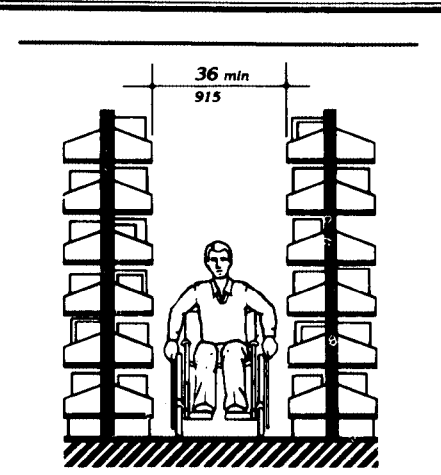


Fig. 56
Stacks

8. LIBRARIES.

8.1 General. In addition to the requirements of 4.1 to 4.33, the design of all public areas of a library shall comply with 8, including reading and study areas, stacks, reference rooms, reserve areas, and special facilities or collections. As provided, elements such as public toilet rooms, telephones, and parking shall be accessible.

8.2 Reading and Study Areas. At least 5 percent or a minimum of one of each element of fixed seating, tables, or study carrels shall comply with 4.2 and 4.32. Clearances between fixed accessible tables and study carrels shall comply with 4.3.

8.3 Check-Out Areas. At least one lane at each check-out area shall comply with 4.32. Any traffic control or book security gates or turnstiles shall comply with 4.13.

8.4 Card Catalogs. Minimum clear aisle space at card catalogs, magazine displays, or reference stacks shall comply with Fig. 55. Maximum reach height shall comply with 4.2, with a height of 48 in (1220 mm) preferred, irrespective of reach allowed.

8.5 Stacks. Minimum clear aisle width between stacks shall comply with 4.3, with a minimum clear aisle width of 42 in (1065 mm) preferred where possible. Shelf height in stack areas is unrestricted (see Fig. 56).

9. POSTAL FACILITIES.

9.1 General. In addition to the requirements of 4.1 to 4.33, the design of U.S. postal facilities shall comply with the requirements of 9. In addition, employee toilet rooms, water fountains, lunchrooms, lounges, attendance-recording equipment, medical treatment rooms, emergency signals, and switches and controls shall be made accessible or adaptable in accordance with the requirements of these standards.

9.2* Post Office Lobbies. Where writing desks or tables are provided, a minimum of at least one writing desk or table that complies with 4.32 must be provided. Clear passageways in front of customer service counters shall be not less than 48 in (1220 mm) clear width to permit maneuvering of a wheelchair. Letter drops shall be mounted at heights that comply with 4.2.

(1) All fixed partitions must be installed to withstand a 250-pound force applied at any point and from any direction. Avoid designs that call for, or may necessitate, non-fixed partitions in circulation routes of handicapped people.

(2) Walls where handrails are provided for handicapped people must be capable of supporting handrails designed to support a 250-pound pull force in any direction.

9.0 Postal Facilities

9.3 Self-Service Postal Centers. Parcel post depositories, stamp vending machines, multi-commodity vending machines, and currency-coin changing machines shall be installed so that the operating mechanisms of all machines comply with 4.2 and 4.27. All mechanisms must be installed to permit close parallel approach by a wheelchair user.

9.4 Post Office Boxes. At least 5 percent of the post office boxes in a facility shall be accessible to wheelchair users. The total number of accessible post office boxes provided shall include a representative number of each of the standard USPS boxes currently being installed. Accessible post office boxes shall be located in the second or third set of modules from the floor, approximately 12 in to 36 in (305 mm to 915 mm) above the finished floor. Aisles between post office boxes shall be a minimum of 66 in (1675 mm) clear width.

9.5 Locker Rooms. Lockers in easily accessible areas must be provided for use by handicapped

people. When double-tier lockers are used, only the bottom row of lockers may be assigned for use by wheelchair users. When full length lockers are used, all hooks, shelves, etc., intended for use by people in wheelchairs shall be located no higher than 48 in (1220 mm) above the finished floor. Lockers intended for use by handicapped people shall be equipped with latches and latch handles that comply with 4.27. Unobstructed aisle space in front of lockers used by handicapped people shall be a minimum of 42 in (1065 mm) clear width.

9.6 Attendance-Recording Equipment. Time clocks, card racks, log books, and other work assignment or attendance-recording equipment used by people in wheelchairs must be installed at a height no more than 48 in (1220 mm) above the finished floor. Counter space at check-in areas must be no more than 36 in (915 mm) above the finished floor.

Appendix

APPENDIX

This appendix contains additional information that should help the designer to understand the minimum requirements of the standard or to design buildings or facilities for greater accessibility. The paragraph numbers correspond to the sections or paragraphs of the standard to which the material relates and are therefore not consecutive (for example, A4.2.1 contains additional information relevant to 4.2.1). Sections for which additional material appears in this appendix have been indicated by an asterisk.

A4.2 Space Allowances and Reach Ranges.**A4.2.1 Wheelchair Passage Width.**

(1) **Space Requirements for Wheelchairs.** Most wheelchair users need a 30 in (760 mm) clear opening width for doorways, gates, and the like, when the latter are entered head-on. If the wheelchair user is unfamiliar with a building, if competing traffic is heavy, if sudden or frequent movements are needed, or if the wheelchair must be turned at an opening, then greater clear widths are needed. For most situations, the addition of an inch of leeway on either side is sufficient. Thus, a minimum clear width of 32 in (815 mm) will provide adequate clearance. However, when an opening or a restriction in a passageway is more than 24 in (610 mm) long, it is essentially a passageway and must be at least 36 in (915 mm) wide.

(2) **Space Requirements for Use of Walking Aids.** Although people who use walking aids can maneuver through clear width openings of 32 in (815 mm), they need 36 in (915 mm) wide passageways and walks for comfortable gaits. Crutch tips, often extending down at a wide angle, are a hazard in narrow passageways where they might not be seen by other pedestrians. Thus, the 36 in (915 mm) width provides a safety allowance both for the disabled person and for others.

(3) **Space Requirements for Passing.** Able-bodied people in winter clothing, walking straight ahead with arms swinging, need 32 in (815 mm) of width, which includes 2 in (50 mm) on either side for sway, and another 1 in (25 mm) tolerance on either side for clearing nearby objects or other pedestrians. Almost all wheelchair users and those who use walking aids can also manage within this 32 in (815 mm) width for short distances. Thus, two streams of traffic can pass in 64 in (1625 mm) in a comfortable flow. Sixty inches (1525 mm) provide a minimum width for a somewhat more restricted flow. If the clear width is less than 60 in (1525 mm), two wheelchair users will not be able to pass but will have to seek a wider place for passing. Forty-eight inches (1220 mm) is the minimum width needed for an ambulatory person to pass a nonambulatory or semiambulatory person. Within this 48 in (1220 mm) width, the ambulatory person will have to twist to pass a wheelchair user, a person with a

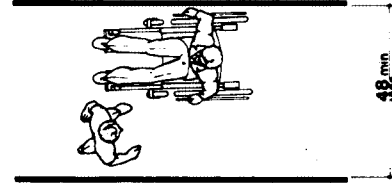


Fig. A1
Minimum Passage Width for One Wheelchair and One Ambulatory Person

seeing eye dog, or a semiambulatory person. There will be little leeway for swaying or missteps (see Fig. A1).

A4.2.3 Wheelchair Turning Space. This standard specifies a minimum space of 60 in (1525 mm) diameter for a pivoting 180-degree turn of a wheelchair. This space is usually satisfactory for turning around, but many people will not be able to turn without repeated tries and bumping into surrounding objects. The space shown in Fig. A2 will allow most wheelchair users to complete U-turns without difficulty.

A4.2.4 Clear Floor or Ground Space for Wheelchairs. The wheelchair and user shown in Fig. A3 represent typical dimensions for a large adult male. The space requirements in this standard are based upon maneuvering clearances that will accommodate most larger wheelchairs. Fig. A3 provides a uniform reference for design not covered by this standard.

A4.2.5 & A4.2.6 Reach. Reach ranges for persons seated in wheelchairs may be further clarified by Fig. A3(a). These drawings approximate in the plan view information shown in Fig. 4, 5, and 6 in other views.

A4.3 Accessible Route.**A4.3.1 General.**

(1) **Travel Distances.** Many disabled people can move at only very slow speeds; for many, traveling 200 ft (61 m) could take about 2 minutes. This assumes a rate of about 1.5 ft/s (455 mm/s) on level ground. It also assumes that the traveler would move continuously. However, on trips over 100 ft (30 m), disabled people are apt to rest frequently, which substantially increases their trip times. Resting periods of 2 minutes for every 100 ft (30 m) can be used to estimate travel times for people with severely limited stamina. In

A4.4 Protruding Objects

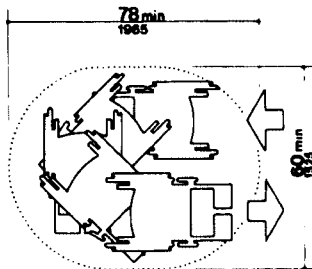
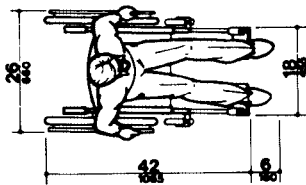
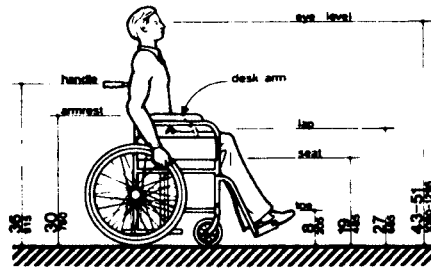


Fig. A2
Space Needed for Smooth U-Turn in a Wheelchair



NOTE: Footrests may extend further for very large people.

Fig. A3
Dimensions of Adult-Sized Wheelchairs

inclement weather, slow progress and resting can greatly increase a disabled person's exposure to the elements.

(2) Sites. Level, indirect routes or those with running slopes lower than 1:20 can sometimes provide more convenience than direct routes with maximum allowable slopes or with ramps.

A4.3.10 Egress. In buildings where physically handicapped people are regularly employed or are residents, an emergency management plan for their evacuation also plays an essential role in fire safety.

A4.4 Protruding Objects.

A4.4.1 General. Guide dogs are trained to recognize and avoid hazards. However, most people with severe impairments of vision use the long cane as an aid to mobility. The two principal cane techniques are the touch technique, where the cane arcs from side to side and touches points outside both shoulders; and the diagonal technique, where the cane is held in a stationary position diagonally across the body with the cane tip touching or just above the

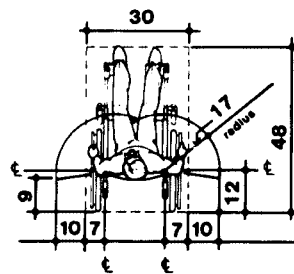
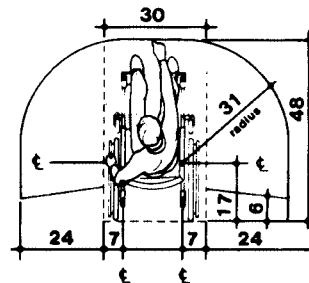
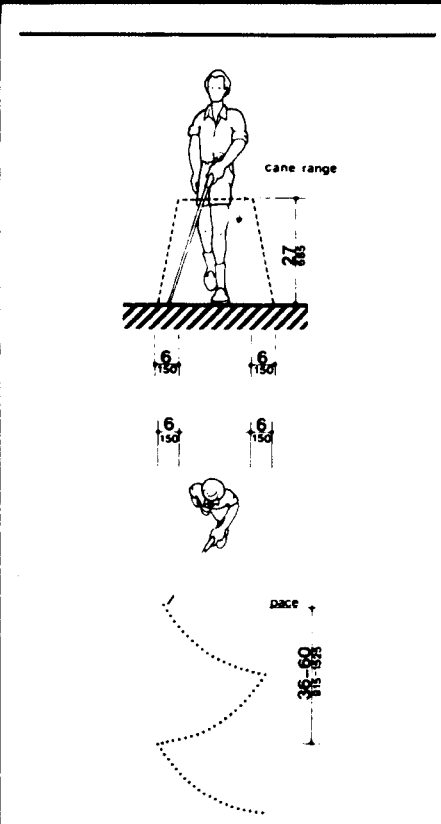


Fig. A3 (a)

A4.4 Protruding Objects



**Fig. A4
Cane Technique**

ground at a point outside one shoulder and the handle or grip extending to a point outside the other shoulder. The touch technique is used primarily in uncontrolled areas, while the diagonal technique is used primarily in certain limited, controlled, and familiar environments. Cane users are often trained to use both techniques.

Potential hazardous objects are noticed only if they fall within the detection range of canes (see Fig. A4). Visually impaired people walking toward an object can detect an overhang if its lowest surface is not higher than 27 in (685 mm). When walking alongside project-

ing objects, they cannot detect overhangs. Since proper cane and guide dog techniques keep people away from the edge of a path or from walks, a slight overhang of no more than 4 in (100 mm) is not hazardous.

A4.5 Ground and Floor Surfaces.

A4.5.1 General. Ambulant and semiambulant people who have difficulty maintaining balance and those with restricted gaits are particularly sensitive to slipping and tripping hazards. For such people, a stable and regular surface is necessary for safe walking, particularly on stairs. Wheelchairs can be propelled most easily on surfaces that are hard, stable, and regular. Soft, loose surfaces such as shag carpet, loose sand, and wet clay, and irregular surfaces, such as cobblestones, can significantly impede wheelchair movement.

Slip resistance is based on the frictional force necessary to keep a shoe heel or crutch tip from slipping on a walking surface under the conditions of use likely to be found on the surface. Although it is known that the static coefficient of friction is the basis of slip resistance, there is not as yet a generally accepted method to evaluate the slip resistance of walking surfaces.

Cross slopes on walks and ground or floor surfaces can cause considerable difficulty in propelling a wheelchair in a straight line.

A4.5.3 Carpet. Much more needs to be done in developing both quantitative and qualitative criteria for carpeting. However, certain functional characteristics are well established. When both carpet and padding are used, it is desirable to have minimum movement (preferably none) between the floor and the pad and the pad and the carpet, which would allow the carpet to hump or warp. In heavily trafficked areas, a thick, soft (plush) pad or cushion, particularly in combination with long carpet pile, makes it difficult for individuals in wheelchairs and those with other ambulatory disabilities to get about. This should not preclude their use in specific areas where traffic is light. Firm carpeting can be achieved through proper selection and combination of pad and carpet, sometimes with the elimination of the pad or cushion, and with proper installation.

A4.6 Parking and Passenger Loading Zones.

A4.6.3 Parking Spaces. High-top vans, which disabled people or transportation services often use, require higher clearances in parking garages than automobiles. *When optional van spaces are provided within a garage, only the spaces themselves and a vehicle route to them require the specified clearances.*

A4.6.4 Signage. Signs designating parking places for disabled people can be seen from a driver's seat if the signs are mounted high enough above the ground and located at the front of a parking space.

A4.13 Doors

A4.8 Ramps.

A4.8.1 General. Ramps are essential for wheelchair users if elevators or lifts are not available to connect different levels. However, some people who use walking aids have difficulty with ramps and prefer stairs.

A4.8.2 Slope and Rise. The ability to manage an incline is related to both its slope and its length. Wheelchair users with disabilities affecting arms or with low stamina have serious difficulty using inclines. Most ambulatory people and most people who use wheelchairs can manage a slope of 1:16. Many people cannot manage a slope of 1:12 for 30 ft (9 m). Many people who have difficulty negotiating very long ramps at relatively shallow slopes can manage very short ramps at steeper slopes.

A4.8.5 Handrails. The requirements for stair and ramp handrails in this standard are for adults. When children are principal users in a building or facility, a second set of handrails at an appropriate height can assist them and aid in preventing accidents.

A4.10 Elevators.

A4.10.6 Door Protective and Reopening Device. The required door reopening device would hold the door open for 20 seconds if the doorway remains unobstructed. After 20 seconds, the door may begin to close. However, if designed in accordance with ANSI A17.1-1978, the door closing movement could still be stopped if a person or object exerts sufficient force at any point on the door edge.

A4.10.7 Door and Signal Timing for Hall Calls. This paragraph allows variation in the location of call buttons, advance time for warning signals, and the door-holding period used to meet the time requirement.

A4.10.12 Car Controls. Industry-wide standardization of elevator control panel design would make all elevators significantly more convenient for use by people with severe visual impairments.

In many cases, it will be possible to locate the highest control on elevator panels within 48 in (1220 mm) from the floor.

A4.10.13 Car Position Indicators. A special button may be provided that would activate the audible signal within the given elevator only for the desired trip, rather than maintaining the audible signal in constant operation.

A4.10.14 Emergency Communications. A device that requires no handset is easier to use by people who have difficulty reaching.

A4.11 Platform Lifts.

Platform lifts include porch lifts and other devices used for short-distance, vertical transportation of people in

wheelchairs. At the present time, generally recognized safety standards for such lifts have not been developed. Care should be taken in selecting and installing lifts to ensure that they are free from hazards to users or to other individuals who may be in the vicinity where they are being operated.

A4.13 Doors.

A4.13.8 Thresholds at Doorways. Thresholds and surface height changes in doorways are particularly inconvenient for wheelchair users who also have low stamina or restrictions in arm movement, because complex maneuvering is required to get over the level change while operating the door.

A4.13.9 Door Hardware. Some disabled persons must push against a door with their chair or walker to open it. Applied kickplates on doors with closers can reduce required maintenance by withstanding abuse from wheelchairs and canes. To be effective, they should cover the door width, less approximately 2 in (51 mm), up to a height of 16 in (405 mm) from its bottom edge and be centered across the top.

A4.13.10 Door Closers. Closers with delayed action features give a person more time to maneuver through doorways. They are particularly useful on frequently used interior doors such as entrances to toilet rooms.

A4.13.11 Door Opening Force. Although most people with disabilities can exert at least 5 lbf (22.2N), both pushing and pulling from a stationary position, a few people with severe disabilities cannot exert even 3 lbf (13.3N). Although some people cannot manage the allowable forces in this standard and many others have difficulty, door closers must have certain minimum closing forces to close doors satisfactorily. Forces for pushing or pulling doors open are measured with a push-pull scale under the following conditions:

(1) Hinged doors: Force applied perpendicular to the door at the door opener or 30 in (760 mm) from the hinged side, whichever is farther from the hinge.

(2) Sliding or folding doors: Force applied parallel to the door at the door pull or latch.

(3) Application of force: Apply force gradually so that the applied force does not exceed the resistance of the door.

In high-rise buildings, air-pressure differentials may require a modification of this specification in order to meet the functional intent.

A4.13.12 Automatic Doors and Power-Assisted Doors. Sliding automatic doors do not need guard rails and are more convenient for wheelchair users and visually impaired people to use. If slowly opening automatic doors can be reactivated before their closing cycle is completed, they will be more convenient in busy doorways.

A4.15 Drinking Fountains and Water Coolers

A4.15 Drinking Fountains and Water Coolers.

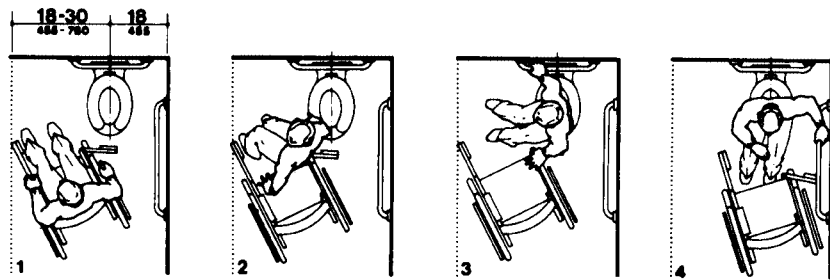
A4.15.2 Drinking fountains with two spouts can assist both handicapped people and those people who find it difficult to bend over.

A4.16 Water Closets.

A4.16.3 Height. Preferences for toilet seat heights vary considerably among disabled people. Higher seat heights may be an advantage to some ambulatory disabled people but a disadvantage for wheelchair

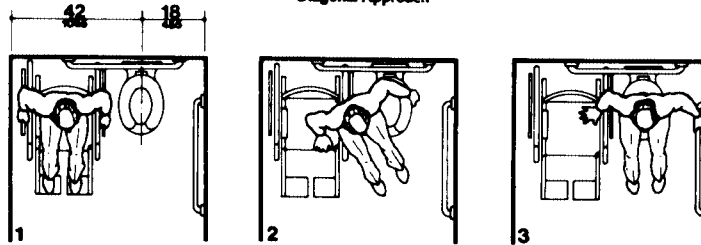
users and others. Toilet seats 18 in (455 mm) high seem to be a reasonable compromise. Thick seats and filler rings are available to adapt standard fixtures to these requirements.

A4.16.4 Grab Bars. Fig. A5(a) and (b) show the diagonal and side approaches most commonly used to transfer from a wheelchair to a water closet. Some wheelchair users can transfer from the front of the toilet, while others use a 90-degree approach. Most people who use the two additional approaches can also use either the diagonal approach or the side approach.



1 Takes transfer position, swings footrest out of the way, sets brakes.
 2 Removes armrest, transfers.
 3 Moves wheelchair out of the way, changes position (some people fold chair or pivot it 90° to the toilet).
 4 Positions on toilet, releases brake.

(a) Diagonal Approach



1 Takes transfer position, removes armrest, sets brakes.
 2 Transfers.
 3 Positions on toilet.

(b) Side Approach

Fig. A5
Wheelchair Transfers

A4.29 Tactile Warnings

A4.16.5 Flush Controls. Flush valves and related plumbing can be located behind walls or to the side of the toilet, or a toilet seat lid can be provided if plumbing fittings are directly behind the toilet seat. Such designs reduce the chance of injury and imbalance caused by leaning back against the fittings. Flush controls for tank-type toilets have a standardized mounting location on the left side of the tank (facing the tank). Tanks can be obtained by special order with controls mounted on the right side. If administrative authorities require flush controls for flush valves to be located in a position that conflicts with the location of the rear grab bar, then that bar may be split or shifted toward the wide side of the toilet area.

A4.17 Toilet Stalls.

A4.17.5 Doors. To make it easier for wheelchair users to close toilet stall doors, doors can be provided with closers, spring hinges, or a pull bar mounted on the inside surface of the door near the hinge side.

A4.19 Lavatories and Mirrors.

A4.19.6 Mirrors. If mirrors are to be used by both ambulatory people and wheelchair users, then they must be at least 74 in (1880 mm) high at their topmost edge. A single full length mirror can accommodate all people, including children.

A4.21 Shower Stalls.

A4.21.1 General. Shower stalls that are 36 in by 36 in (915 mm by 915 mm) wide provide additional safety to people who have difficulty maintaining balance because all grab bars and walls are within easy reach. Seated people use the walls of 36 in by 36 in (915 mm by 915 mm) showers for back support. Shower stalls that are 60 in (1525 mm) wide and have no curb may increase usability of a bathroom by wheelchair users because the shower area provides additional maneuvering space.

A4.23 Bathrooms, Bathing Facilities, and Shower Rooms.

A4.23.9 Medicine Cabinets. Other alternatives for storing medical and personal care items are very useful to disabled people. Shelves, drawers, and floor-mounted cabinets can be provided within the reach ranges of disabled people.

A4.26 Handrails, Grab Bars, and Tub and Shower Seats.

A4.26.1 General. Many disabled people rely heavily upon grab bars and handrails to maintain balance and prevent serious falls. Many people brace their forearms between supports and walls to give them more leverage and stability in maintaining balance or for lifting. The maximum grab bar clearance of 1-1/2 in (38 mm) required in this standard is a safety clearance to prevent injuries from arms slipping through the opening. It also provides adequate gripping room.

A4.26.2 Size and Spacing of Grab Bars and Handrails. This specification allows for alternate shapes of handrails as long as they allow an opposing grip similar to that provided by a circular section of 1-1/4 in to 1-1/2 in (32 mm to 38 mm).

A4.27 Controls and Operating Mechanisms.

A4.27.3 Height. Fig. A6 further illustrates mandatory and advisory control mounting height provisions for typical equipment. Note distinction between built-in equipment (considered real property) and movable equipment (considered chattel, and not covered by the Architectural Barriers Act of 1968).

A4.28 Alarms.

A4.28.2 Audible Alarms. Audible emergency signals must have an intensity and frequency that can attract the attention of individuals who have partial hearing loss. People over 60 years of age generally have difficulty perceiving frequencies higher than 10,000 Hz.

A4.28.3 Visual Alarms. The specifications in this section do not preclude the use of zoned or coded alarm systems. In zoned systems, the emergency exit lights in an area will flash whenever an audible signal rings in the area.

A4.28.4 Auxiliary Alarms. Locating visual emergency alarms in rooms where deaf individuals may work or reside alone can ensure that they will always be warned when an emergency alarm is activated. To be effective, such devices must be located and oriented so that they will spread signals and reflections throughout a space or raise the overall light level sharply. The amount and type of light necessary to wake a deaf person from a sound sleep in a dark room will vary depending on a number of factors, including the size and configuration of the room, the distance between the source and the person, whether or not the light flashes, and the cycle of flashing. A 150-watt flashing bulb can be effective under some conditions. Certain devices currently available are designed specifically as visual alarms for deaf people. Deaf people may not need accessibility features other than the emergency alarm connections and communications devices. Thus, rooms in addition to those accessible for wheelchair users also should be equipped with emergency visual alarms or connections.

A4.29 Tactile Warnings.

A4.29.2 Tactile Warnings on Walking Surfaces. (Reserved).

A4.29.3 Tactile Warnings on Doors to Hazardous Areas. Tactile signals for hand reception are useful if it is certain that the signals will be touched.

A4.29.5 Tactile Warnings at Hazardous Vehicular Areas. (Reserved).

4.29 Tactile Warnings

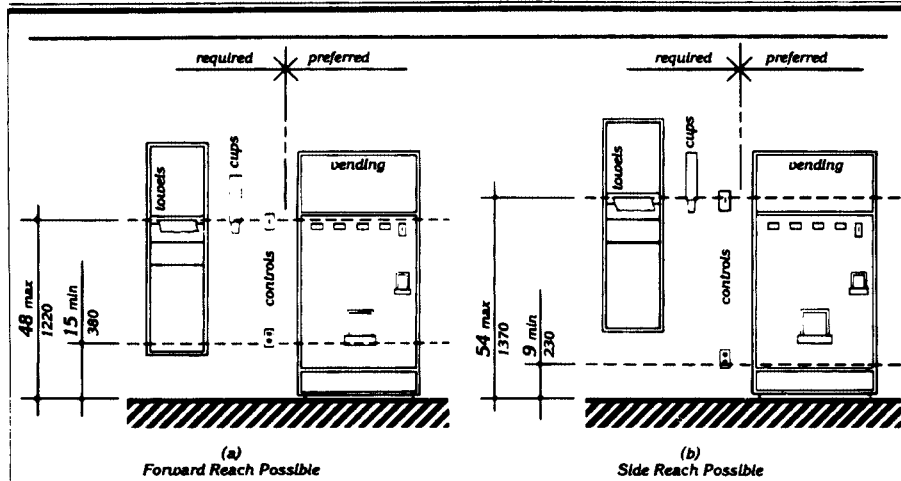


Fig. A6
Control Reach Limitations

A4.29.6 Tactile Warnings at Reflecting Pools.
(Reserved).

A4.29.7 Standardization. Too many tactile warnings or lack of standardization weakens their usefulness. Tactile signals can also be visual signals to guide dogs, since dogs can be trained to respond to a large variety of visual cues.

A4.30 Signage.

A4.30.1 General. In building complexes where finding locations independently on a routine basis may be a necessity (for example, college campuses), tactile maps or prerecorded instructions can be very helpful to visually impaired people. Several maps and auditory instructions have been developed and tested for specific applications. The type of map or instructions used must be based on the information to be communicated, which depends highly on the type of buildings or users.

Landmarks that can easily be distinguished by visually impaired individuals are useful as orientation cues. Such cues include changes in illumination level, bright colors, unique patterns, wall murals, location of special equipment, or other architectural features (for example, an exterior view).

Many people with disabilities have limitations in movement of their head and reduced peripheral vision. Thus, signage positioned perpendicular to the path of

travel is easiest for them to notice. People can generally distinguish signage within an angle of 30 degrees to either side of the centerline of their face without moving their head.

A4.30.2 Character Proportion. The legibility of printed characters is a function of the viewing distance, character height, the ratio of the stroke width to the height of the character, the contrast of color between character and background, and print font. The size of characters must be based upon the intended viewing distance. A severely nearsighted person may have to be much closer to see a character of a given size accurately than a person with normal visual acuity.

A4.30.3 Color Contrast. The greatest readability is usually achieved through the use of light-colored characters or symbols on a dark background.

A4.30.4 Raised or Indented Characters or Symbols. Signs with descriptive materials about public buildings, monuments, and objects of cultural interest can be raised or incised letters. However, a sighted guide or audio-tape device is often a more effective way to present such information. Raised characters are easier to feel at small sizes and are not susceptible to maintenance problems as are indented characters, which can fill with dirt, cleaning compounds, and the like.

Braille characters can be used in addition to standard alphabet characters and numbers. Placing braille

A4.33 Assembly Areas

characters to the left of standard characters makes them more convenient to read. Standard dot sizing and spacing as used in braille publications are acceptable. Raised borders around raised characters can make them confusing to read unless the border is set far away from the characters.

A4.31 Telephones.

A4.31.3 Mounting Height. In localities where the dial-tone first system is in operation, calls can be placed at a coin telephone through the operator without inserting coins. The operator button is located at a height of 46 in (1170 mm) if the coin slot of the telephone is at 54 in (1370 mm).

A generally available public telephone with a coin slot mounted lower on the equipment would allow universal installation of telephones at a height of 48 in (1220 mm) or less to all operable parts.

A4.31.5 Equipment for Hearing Impaired People. Other aids for people with hearing impairments are telephones, teleprinter, and other telephonic devices that can be used to transmit printed messages through telephone lines to a teletype printer or television monitor.

A4.32 Seating, Tables, and Work Surfaces.

A4.32.4 Height of Work Surfaces. Different types of work require different work surface heights for comfort and optimal performance. Light detailed work such as writing requires a work surface close to elbow height for a standing person. Heavy manual work such as rolling dough requires a work surface height about 10 in (255 mm) below elbow height for a standing person. The principle of a high work surface height for light detailed work and a low work surface for heavy manual work also applies for seated persons; however, the limiting condition for seated manual work is clearance under the work surface.

Table A1 shows convenient work surface heights for seated persons. The great variety of heights for comfort and optimal performance indicates a need for alternatives or a compromise in height if people who stand and people who sit will be using the same counter area.

A4.33 Assembly Areas.

A4.33.2 Size of Wheelchair Locations. Spaces large enough for two wheelchairs allow people who are coming to a performance together to sit together.

A4.33.3 Placement of Wheelchair Locations. The location of wheelchair areas can be planned so that a variety of positions within the seating area are provided. This will allow choice in viewing and price categories.

A4.33.6 Placement of Listening Systems. A distance of 50 ft (15 m) allows a person to distinguish performers' facial expressions.

**Table A1
Convenient Heights of
Work Surfaces for Seated People***

Conditions of Use	Short Women		Tall Men	
	in	mm	in	mm
Seated in a wheelchair:				
Manual work:				
Desk or removable armrests	26	660	30	760
Fixed, full-size armrests†	32‡	815	32‡	815
Light, detailed work:				
Desk or removable armrests	29	735	34	865
Fixed, full-size armrests†	32‡	815	34	865
Seated in a 16-in (405-mm) high chair:				
Manual work	26	660	27	685
Light, detailed work	28	710	31	785

*All dimensions are based on a work surface thickness of 1-1/2 in (38 mm) and a clearance of 1-1/2 in (38 mm) between legs and the underside of a work surface.

†This type of wheelchair arm does not interfere with the positioning of a wheelchair under a work surface.

‡This dimension is limited by the height of the armrests; a lower height would be preferable. Some people in this group prefer lower work surfaces, which require positioning the wheelchair back from the edge of the counter.

A4.33.7 Types of Listening Systems. A listening system that can be used from any seat in a seating area is the most flexible way to meet this specification. Earphone jacks with variable volume controls can benefit only people who have slight hearing losses and do not help people with hearing aids. At the present time, audio loops are the most feasible type of listening system for people who use hearing aids, but people without hearing aids or those with hearing aids not equipped with inductive pickups cannot use them. Loops can be portable and moved to various locations within a room. Moreover, for little cost, they can serve a large area within a seating area. Radio frequency systems can be extremely effective and inexpensive. People without hearing aids can use them, but people with hearing aids need custom-designed equipment to use them as they are presently designed. If hearing aids had a jack to allow a by-pass of microphones, then radio frequency systems would be suitable for people with and without hearing aids. Some listening systems may be subject to interference from other equipment and feedback from hearing aids of people who are using the systems. Such interference can be controlled by careful engineering design that anticipates feedback and sources of interference in the surrounding area.

A4.34 Dwelling Units

<p>A4.34 Dwelling Units.</p> <p>A4.34.2 Minimum Requirements. Handicapped people who live in accessible dwelling units of multi-family buildings or housing projects will want to participate in all on-site social activities, including visiting neighbors in their dwelling units. Hence, any circulation paths among all dwelling units and among all on-site facilities should be as accessible as possible. An accessible second exit to dwelling units provides an extra margin of safety in a fire.</p> <p>A4.34.5 Bathrooms. Although not required by these specifications, it is important to install grab bars at toilets, bathtubs, and showers if it is known that a dwelling unit will be occupied by elderly or severely disabled people.</p> <p>A4.34.6 Kitchens.</p> <p>A4.34.6.1 Clearance. The minimum clearances provide satisfactory maneuvering spaces for wheelchairs only if cabinets are removed at the sink.</p> <p>A4.34.6.5 Sink. Installing a sink with a drain at the rear so that plumbing is as close to the wall as possible can provide additional clear knee space for wheelchair users.</p> <p>A4.34.6.6 Ranges and Cooktops. Although not required for minimum accessibility, countertop range units in a counter with adjustable heights can be an added convenience for wheelchair users.</p> <p>A4.34.6.7 Ovens. Countertop or wall-mounted ovens with side-opening doors are easier for people in wheelchairs to use. Clear spaces at least 30 in (760</p>	<p>mm) wide under counters at the side of ovens are an added convenience. The pullout board or fixed shelf under side-opening oven doors provides a resting place for heavy items being moved from the oven to a counter.</p> <p>A4.34.6.8 Refrigerator/Freezers. Side-by-side refrigerator/freezers provide the most usable freezer compartments. Locating refrigerators so that their doors can swing back 180 degrees is more convenient for wheelchair users.</p> <p>A4.34.6.10 Kitchen Storage. Full height cabinets or tall cabinets can be provided rather than cabinets mounted over work counters. Additional storage space located conveniently adjacent to kitchens can be provided to make up for space lost when cabinets under counters are removed.</p> <p>A9. Postal Facilities.</p> <p>A9.2 Post Office Lobbies. <i>Furniture as chattel is not covered under the Architectural Barriers Act of 1968, but the requirements for lobby furniture and equipment are imposed by the United States Postal Service for greater accessibility in its customer lobbies.</i></p> <p>Note: Unedited copies of the American National Standards Institute standard, A117.1-1980, "Specifications for Making Buildings and Facilities Accessible to and Usable by Physically Handicapped People," are available from the American National Standards Institute, Inc., 1430 Broadway, New York, New York 10018.</p>
---	--

Access Aisles**INDEX****ACCESS AISLES**

Definition of	3.5
Parking & Passenger Loading Zones	4.6.3, 4.6.5
Restaurants & Cafeterias	5.1

ACCESS TO PERFORMING ARTS (See PERFORMING AREAS)**ACCESSIBLE ROUTE (See also ACCESS AISLE; CIRCULATION PATH/ROUTE) 4.3, A4.3***

Assembly Area	4.33.3, 4.33.5
Bathrooms, Bathing Facilities & Shower Rooms	4.23.1
Curb Ramps	4.7.1, 4.7.2
Definition of	3.5
Doors	4.13.2
Dwelling Units: Bathrooms	4.34.5
Dwelling Units: Laundry Facilities	4.34.7.1
Dwelling Units: Kitchens	4.34.6
Dwelling Units: Minimum Requirements	4.34.2, (3), (15), 4.34.5, 4.34.6, 4.34.7
Elevators	4.10.1
Entrances	4.14.1
Ground & Floor Surfaces	4.5.1
Head Room	4.3.5
Historic Preservation: Applicability	4.1.7(1)(b)
Lavatories & Mirrors	4.19.3
Minimum Number: Additions	4.1.5(2)
Minimum Number: Alterations	4.1.6(3)(a), (4)(f)(i), (ii)
Minimum Number: Historic Preservation	4.1.7, (2)(a),(c),(d)
Minimum Number: Housing	4.1.3(3)
Minimum Number: New Construction	4.1.2(1),(3),(7)(c),(9),(10),(12)
Minimum Number: Sites & Exterior Facilities	4.1.1(1),(2),(4)
Parking & Passenger Loading Zones	4.6.2, 4.6.3
Protruding Objects	4.4.1, 4.4.2
Ramps	4.8.1
Restaurants & Cafeterias	5.1
Sinks	4.24.5
Space Allowances & Reach Ranges	4.2.4.2
Stairs	4.9.2
Toilet Rooms	4.22.1, 4.22.3, 4.22.7
Toilet Stalls	4.17.1
Urinals	4.18.3

ADAPTABILITY (See also DWELLING UNITS; KITCHENS)

Adaptable Features: Consumer Information	4.34.4
Adaptability	4.34.3
Definition of	3.5
Occupancy Classification: Military Housing	4.1.4(3)

ADAPTABLE BATHROOMS (See DWELLING UNITS)**ADAPTABLE KITCHENS (See KITCHENS)****ADDITIONS**

Definition of	3.5
Minimum Number: Additions	4.1.5

ADMINISTRATIVE AUTHORITY/AUTHORITIES

Accessible Route: Areas of Refuge	4.3.10
Definition of	3.5
Fire Door Opening Force	4.13.1(1)
Location of Flush Controls	A4.16.5
Platform Lifts: Safety Regulations	4.11.2
Toilet Stalls: Plumbing Code Requirements	4.17.3
Use of Residential or Enclosed Wheelchair Lifts	4.10.1

ALARMS 4.28, A4.28

Audible Alarms	4.1.2(13), 4.28.2, 4.28.3, A4.28.2
----------------------	------------------------------------

*Bold denotes major sections of Uniform Federal Accessibility Standards

Bedrooms**ALARMS (CONTINUED)**

Audible Signal (See ELEVATORS)	
Auditory Alarms	4.28.4
Alarms in Dwelling Units (See DWELLING UNITS)	
Emergency Alarms (See EMERGENCY WARNING SYSTEMS)	
Minimum Number: Alterations	4.1.6(3)(d)(iv)
Visual Alarms	4.1.2(13), 4.28.3, A4.28.3

ALTERATIONS

Definition of	3.5
Historic Preservation: Applicability	4.1.7(1)(e)
Minimum Number: Alterations	4.1.6
Toilet Stalls: Exceptions	4.17.3

ASSEMBLY AREAS (See also CONFERENCE ROOMS; MEETING ROOMS; SEATING, TABLES & WORK SURFACES; PERFORMING AREAS) 4.33, A4.33

Access to Performing Areas (See PERFORMING AREAS)	
Balconies	4.33.3
Definition of	3.5
Egress (See EGRESS)	
Fixed Seating Plan	4.33.3
Minimum Number: Alterations	4.1.6(3)(d)(vii), (4)(f)
Minimum Number: New Construction	4.1.2(18)
Occupancy Classification: Assembly	4.1.4(4)
Occupancy Classification: Military Exclusions	4.1.4(2)(c)
Placement of Listening Systems (See LISTENING SYSTEMS)	
Placement of Wheelchair Seating Areas	4.33.3, A4.33.3
Size of Wheelchair Locations	4.33.2, A4.33.2
Surfaces (See GROUND & FLOOR SURFACES)	
Types of Listening Systems (See LISTENING SYSTEMS)	

ASSEMBLY OCCUPANCY 4.1.4(4)**AUDIO-AMPLIFICATION SYSTEMS (See also LISTENING SYSTEMS)**

Auditory Instructions	A4.30.1, A4.30.4
Minimum Number: New Construction	4.1.2(18)(b)
Types of Listening Systems (See LISTENING SYSTEMS)	

AUTOMATIC DOORS (See DOORS)**BALCONIES (See ASSEMBLY AREAS; DWELLING UNITS)****BATHROOMS, BATHING FACILITIES & SHOWER ROOMS (See also BATHTUBS) 4.23**

Bathing & Shower Facilities: Minimum Number	4.23.8
Bathrooms in Dwelling Units (See DWELLING UNITS)	
Clear Floor Space	4.23.3
Controls & Dispensers (See CONTROLS & OPERATING MECHANISMS)	
Doors (See DOORS)	
Lavatories & Mirrors: Minimum Number	4.23.6
Medicine Cabinets: Minimum Number	4.23.9, A4.23.9
Medicine Cabinets in Dwelling Units (See DWELLING UNITS)	
Minimum Number: Additions	4.1.5(3)
Minimum Number: Alterations	4.1.6(3)(c)
Minimum Number: New Construction	4.1.2(10)
Minimum Number: New Construction/Bathing Facilities	4.1.1(6), (7)(d)
Urinals: Minimum Number	4.23.5
Water Closets: Minimum Number	4.23.4

BATHTUBS (See also BATHROOMS, BATHING FACILITIES & SHOWER ROOMS; SHOWER STALLS) 4.20

Bathtub Enclosures	4.20.7
Bathtub Enclosures in Dwelling Units (See DWELLING UNITS)	
Clear Floor Space	4.23.3
Controls (See CONTROLS & OPERATING MECHANISMS)	
Grab Bars (See HANDRAILS, GRAB BARS & TUB & SHOWER SEATS)	
In-tub Seats	4.20.3, 4.20.7, 4.26.3
Shower Unit (See SHOWER SPRAY UNITS)	

BEDROOMS (See DWELLING UNITS; HEALTH CARE)

71

Business Occupancy

BUSINESS OCCUPANCY	4.1.4(5)
CABINETS	
Cabinets for Kitchens (See KITCHENS)	
Medicine Cabinets (See BATHROOMS, BATHING FACILITIES & SHOWER ROOMS)	
Occupancy Classification: Factory Industrial	
Storage Cabinets (See STORAGE)	4.1.4(7)
CAFETERIAS (See RESTAURANTS & CAFETERIAS)	
CARD CATALOGS (See LIBRARIES)	
CARPET (See also GROUND & FLOOR SURFACES)	
Occupancy Classification: Factory Industrial	4.1.4(7)
Carpet & Carpet Tile	4.5.3, A4.5.3
CARPET TILE (See CARPET)	
CARPORTS (See DWELLING UNITS)	
CHANGES IN LEVELS (See also ELEVATORS; STAIRS; PLATFORM LIFTS)	
Accessible Route	4.3.8
Ground & Floor Surfaces	4.5.2
Thresholds at Doorways	4.13.8, A4.13.8
CHARACTER PROPORTION (See SIGNAGE)	
CHECK-OUT AISLES (See MERCANTILE)	
CHILD CARE FACILITIES	
Occupancy Classification: Institutional	4.1.4(9)
CIRCULATION PATH/ROUTE (See also ACCESS AISLE; ACCESSIBLE ROUTE)	
Definition of	3.5
Dwelling Units	A4.34.2
Head Room	4.4.2
Location of Parking & Passenger Loading Zones	4.6.2
Minimum Number: New Construction	4.1.2(2)
Minimum Number: Sites & Exterior Facilities	4.1.1(3)
Parking Spaces (See PARKING & PASSENGER LOADING ZONES)	
Post Office Lobbies	9.2(1)
CLEAR FLOOR SPACE FOR WHEELCHAIRS (See CLEARANCES FOR WHEELCHAIRS)	
CLEAR KNEE SPACE (See KNEE & TOE CLEARANCE)	
CLEAR WIDTH (See CLEARANCES FOR WHEELCHAIRS)	
CLEARANCES FOR WHEELCHAIRS (See also GROUND & FLOOR SURFACES; REACH RANGES)	
Clear Floor Space for Wheelchair	4.2.4, A4.2.4
Maneuvering Clearances	4.2.4.2, 4.10.9, 4.13.6, 9.2
Minimum Clear Width	4.2.4.1
Obstructed Turning Space	4.3.3
Passing Space	4.3.4
Passing Width	4.2.1, A4.2.1
Turning Space	4.2.3, A4.2.3
Unobstructed Aisle Space	9.5
Unobstructed Turning Space	4.2.3, 4.2.2.3, 4.2.3.3
Width for Wheelchair Passing	4.2.2
CLOTHES DRYERS (See DWELLING UNITS)	
CLOTHES RODS (See STORAGE)	
COLOR CONTRAST (See SIGNAGE)	
COMMON AREAS/SPACES (See COMMON USE)	
COMMON USE (See also STREETS & SIDEWALKS)	
Common Areas/Spaces	4.1.4(3), 4.1.5(4), 4.1.6(1)(a), 4.34.2(1)
Definition of	3.5
Laundry Facilities (See DWELLING UNITS)	
Minimum Number: Housing	4.1.3(1)(b)
Minimum Number: New Construction	4.1.2(10)

Detention Facilities

COMMON USE (CONTINUED)

Minimum Number: Sites & Exterior Facilities 4.1.1(6)
 Occupancy Classification: Institutional 4.1.4(9)(a), (b), (c)
 Occupancy Classification: Residential 4.1.4(11)(a)
 Parking Spaces 4.6.3

COMMUNICATION SYSTEMS (See EMERGENCY COMMUNICATION SYSTEMS; SIGNAGE)

CONFERENCE ROOMS

Definition of (See Assembly Areas) 3.5
 Minimum Number: New Construction 4.1.2(18)(b)

CONSUMER INFORMATION (See DWELLING UNITS)

CONTROLS & DISPENSERS (See CONTROLS & OPERATING MECHANISMS; DISPENSERS)

CONTROLS & OPERATING MECHANISMS

4.27, A4.27
 Bathrooms, Bathing Facilities & Shower Rooms: Controls & Dispensers 4.237
 Bathtub Controls in Dwelling Units 4.34.5.4(4)
 Clear Floor Space at Controls & Dispensers 4.27.2
 Definition of (See Operable Part) 3.5
 Door Hardware 4.13.9, A4.13.9
 Drinking Fountains & Water Coolers: Controls 4.15.4
 Elevator Emergency Communication Controls 4.10.14
 Highest Operable Part of Controls & Dispensers 4.27.3, A4.27.3
 Kitchen Controls 4.34.6.3
 Laundry Controls 4.34.7.3
 Lavatory Faucets (See FAUCETS)
 Minimum Number: New Construction 4.1.2(12)
 Minimum Requirements: Housing 4.34.2(9)
 Operable Equipment 4.27.2, 4.27.3
 Operation of Controls & Operating Mechanisms 4.27.4
 Oven Controls 4.34.6.6, 4.34.7
 Postal Facilities Switches & Controls 9.1
 Shower Controls in Dwelling Units 4.34.5.5(4)
 Shower Stall Controls 4.21.5
 Sink Faucets (See FAUCETS)
 Storage Hardware 4.25.4
 Telephone Controls (See TELEPHONES)
 Toilet Room Controls & Dispensers 4.16.6, 4.22.7
 Urinal Flush Controls 4.18.4
 Water Closet Flush Controls 4.16.5, A4.16.5
 Water Closet Dispensers in Dwelling Units 4.34.5.2(4)

COOKTOPS (See KITCHENS)

CORRECTIONAL FACILITIES 4.1.4(9)(c)

CROSS SLOPES (See RAMPS)

CURB RAMPS (See also RAMPS) 4.7

Built-up Curb Ramps 4.7.6
 Changes in Levels Along Accessible Routes 4.3.8
 Curbs 4.6.5, 4.7.1, 4.7.5, 4.7.10, 4.8.7
 Diagonal Curb Ramps 4.7.10
 Definition of 3.5
 Islands (Traffic) 4.7.11
 Location 4.7.1
 Location of Marked Crossings 4.7.9
 Minimum Number: Alterations 4.1.6(1)(b), (4)(a)
 Obstructions by Parked Vehicles 4.7.8
 Passenger Loading Zones 4.6.5
 Sides of Curb Ramps 4.7.5
 Slopes & Rises 4.8.2
 Surfaces (See GROUND & FLOOR SURFACES)
 Uncurbed Intersections 4.7.12
 Width 4.7.3

CURBS (See CURB RAMPS)

DETENTION FACILITIES (See CORRECTIONAL FACILITIES)

Dining Areas

DINING AREAS (See DWELLING UNITS)	
DIRECTIONAL SIGNS (See SIGNAGE)	
DISHWASHERS (See KITCHENS)	
DISPENSERS (See CONTROLS & OPERATING MECHANISMS)	
DISPLAYS	
Historic Preservation: Applicability	4.1.7(1)(b)
Libraries	8.4
Minimum Number: Historic Preservation	4.1.7(2)(e)
Occupancy Classification: Mercantile	4.1.4(10)
Restaurants & Cafeterias	5.3
DOOR & SIGNAL TIMING FOR HALL CALLS (See ELEVATORS)	
DOOR CLOSERS (See ELEVATORS; DOORS)	
DOOR DELAY FOR CAR CALLS (See ELEVATORS)	
DOOR HARDWARE (See CONTROLS & OPERATING MECHANISMS)	
DOOR PROTECTIVE & REOPENING DEVICES (See ELEVATORS)	
DOORS (See also ELEVATORS; ENTRANCES)	4.13, A4.13
Accessible Route: Doors	4.3.9
Automatic Doors & Power-Assisted Doors	4.13.12, A4.13.12
Bathrooms, Bathing Facilities & Shower Rooms: Doors	4.23.2
Clear Opening Width at Doorways	4.13.5, A4.2.1
Definition of (See Automatic Door, Entrance, Power-Assisted Door)	3.5
Door Closers	4.13.10, A4.13.10
Door Opening Force	4.13.11, A4.13.11
Doors to Hazardous Areas (See TACTILE WARNINGS)	
Doors to Patients' Bedrooms	6.3(5)
Double-leaf Doorways	4.13.4
Dwelling Units: Doors	4.34.5.1, 4.34.5.2(6)
Entry Doors to Acute Care Hospital Rooms	4.13.6
Exterior Hinged Doors	4.13.11(2)(a)
Exterior Sliding Doors	4.13.8
Fire Doors	4.13.11(1)
Gates	4.13.3
Hardware (See CONTROLS & OPERATING MECHANISMS)	
Hinged Doors	4.13.11(2)(a),(b), A4.13.11(1)
Interior Hinged Doors	4.13.11(2)(b)
Maneuvering Clearances at Doors	4.8.4(4), 4.13.6
Minimum Number: Alterations	4.1.6(4)(d)
Minimum Number: New Construction	4.1.2(7)
Revolving Doors & Turnstiles	4.13.2, 8.3
Sliding Doors	A4.13.11(2)
Thresholds at Doorways	4.13.8, A4.13.8
Toilet Room Doors	4.22.2
Toilet Stall Doors	4.17.5, A4.17.5
Two Doors in Series	4.13.7
DRESSING ROOMS (See PERFORMING AREAS)	
DRINKING FOUNTAINS & WATER COOLERS	4.15, A4.15
Clearances	4.15.5
Controls (See CONTROLS & OPERATING MECHANISMS)	
Knee Clearance (See KNEE & TOE CLEARANCE)	
Minimum Number: Alterations	4.1.6(3)(d)(ii)
Minimum Number: New Construction	4.1.2(9)
Postal Facilities	9.1
Spout Height	4.15.2, A4.15.2
Spout Location	4.15.3
DWELLING UNITS (See also EGRESS; ENTRANCES; FIXTURES; REACH RANGES; SEATING, TABLES & WORK SURFACES; WATER CLOSETS)	4.34, A4.34
Accessible Route	4.3.2(3), (4)
Adaptable Bathrooms	4.34.5, A4.34.5

Egress**DWELLING UNITS (CONTINUED)**

Adaptability	4.34.3
Alarms	4.34.2(10), 4.34.4(3)
Balconies	4.34.2(15)(d)
Base Cabinets (See KITCHENS)	
Bathrooms	4.34.2(12), 4.34.4(2), 4.34.5, A4.34.5
Bathtubs	4.34.2(12), 4.34.4(2), 4.34.5.4, 4.34.6, A4.34.5
Bath tub Enclosures	4.34.5.6
Bath tub Seats	4.34.5.4(2)
Bath tub & Shower Faucets (See FAUCETS)	
Bedrooms	4.34.2(15)(c)
Cabinets: Minimum Requirements	4.34.2(8)
Carpets	4.1.4(13), 4.34.2(15)(d)
Clothes Dryers	4.34.7.2
Common Spaces & Facilities	4.34.2(1)
Consumer Information	4.34.4
Controls (See CONTROLS & OPERATING MECHANISMS)	
Definition of (See also Housing, Multi-family Dwelling)	3.5
Dining Areas	4.34.2(15)(b)
Doors (See DOORS)	
Emergency Warning Systems (See EMERGENCY WARNING SYSTEMS)	
Entrances	4.34.2(3), (6), (7)
Exits	A4.34.2
Faucets (See FAUCETS)	
Fixed or Hand-held Shower Units (See SHOWER SPRAY UNITS)	
Garages (See GARAGES)	
Grab Bars (See HANDRAILS, GRAB BARS & TUB & SHOWER SEATS)	
Height of Water Closets	4.34.5.2(2)
In-Tub Seats	4.34.5.4(2)
Kitchens (See KITCHENS)	
Laundry Facilities	4.34.2(14), 4.34.6.2, 4.34.7, 4.34.7.1, 4.34.7.2, 4.34.7.3
Lavatories (See LAVATORIES & MIRRORS)	
Living Rooms	4.34.2(15)(a)
Medicine Cabinets	4.34.5.3
Minimum Number: Housing	4.1.3
Minimum Number: Sites & Exterior Facilities	4.1.1(5)(d)(1),(2)
Mirrors (See LAVATORIES & MIRRORS)	
Occupancy Classification: Residential	4.1.4(11)(b), (c)
Parking (See PARKING & PASSENGER LOADING ZONES)	
Patios	4.34.2(15)(d)
Showers	4.34.2(12), 4.34.4(2), 4.34.5
Shower Enclosures	4.34.5.6
Shower Stalls	4.34.2(12), 4.34.4(2), 4.34.5.5, 4.34.5.6, A4.34.5
Shower Seats	4.34.5.5(2)
Sinks (See SINKS)	
Sink Knee Clearance (See KNEE & TOE CLEARANCE)	
Sleeping Areas	4.34.2(15)(c)
Spaces	4.34.2(2)
Storage	4.34.2(8)
Structural Reinforcement	4.34.5.2(3), 4.34.5.4(3), 4.34.5.5(3)
Terraces	4.34.2(15)(d)
Water Closets	4.34.5.2
Washing Machines	4.34.7.2

EDUCATIONAL OCCUPANCY

Occupancy Classification: Business	4.1.4(5)
Occupancy Classification: Educational	4.1.4(6)

EGRESS (See also ENTRANCES; EXITS)

Accessible Route: Egress	4.3.10
Assembly Areas: Placement of Wheelchairs	4.33.3
Definition of	3.5
Fire Safety	A4.3.10
Mercantile: Security Bollards	7.4
Minimum Number: Alterations	4.1.6(4)(f)(i)
Minimum Number: Dwelling Units	4.1.3(2)
Minimum Number: New Construction	4.1.2(7)(d)

Elements & Spaces

ELEMENTS & SPACES (See Specific Element and/or Specific Space)	
Accessible Elements & Spaces: Scope & Technical Requirements	4
Definition of (See Accessible Element, Element, Functional Spaces, Space)	3.5
ELEVATORS (See also CLEARANCES FOR WHEELCHAIRS; SIGNAGE; TACTILE WARNINGS) 4.10, A4.10	
Accessible Routes: Changes in Levels	4.3.8
Audible Signal	4.10.4, 4.10.7, 4.10.13, A4.10.13
Automatic Doors	4.10.6, A4.10.6
Automatic Operation	4.10.2
Car Controls	4.10.11, 4.10.12, A4.10.12
Car Position Indicators	4.10.13, A4.10.13
Control Buttons	4.10.12, A4.10.12
Control Panels	4.10.12, A4.10.12
Door Closers	4.10.6, A4.10.6
Door Delay for Car Calls	4.10.8
Door Protective & Reopening Devices	4.1.6(4)(c)(i), 4.10.6, A4.10.6
Door & Signal Timing for Hall Calls	4.10.7, A4.10.7
Elevator Penthouses	4.1.2(5), 4.1.4(1)
Emergency Alarms (See EMERGENCY WARNING SYSTEMS)	
Emergency Communications (See EMERGENCY COMMUNICATION SYSTEMS)	
Emergency Communication Controls (See CONTROLS & OPERATING MECHANISMS)	
Emergency Controls	4.10.12(3)
Floor Plan of Elevator Cars	4.10.9
Freight Elevators	4.10.1
Hall Call Buttons	4.10.3, 4.10.4(3), 4.10.7, A4.10.7
Hall Lanterns	4.10.4
Hoistway Entrances	4.10.4, 4.10.5
Illumination Levels	4.10.11
Intercommunication Systems (See EMERGENCY COMMUNICATION SYSTEMS)	
Location of Car Controls	4.10.12(4)
Minimum Number: Housing	4.1.3(1)
Minimum Number: Alterations	4.1.6(1)(b), (d), (4)(c)
Minimum Number: New Construction	4.1.2(4), (5)
Occupancy Classification: General Exceptions	4.1.4(1)
Raised Characters on Hoistway Entrances	4.10.5
Recessed Characters	4.10.14
Surfaces (See GROUND & FLOOR SURFACES)	
Tactile Control Indicators	4.10.12(2)
Visible Signal	4.10.3, 4.10.4(3), 4.10.12(2), 4.10.13
Visual Control Indicators	4.10.12(2), 4.10.13
EMERGENCY COMMUNICATION SYSTEMS (See also EMERGENCY WARNING SYSTEMS)	
Elevator Communication Systems	4.10.14, A4.10.14
Intercommunication Systems	4.10.14
EMERGENCY CONTROLS (See ELEVATORS)	
EMERGENCY WARNING SYSTEMS (See also EMERGENCY COMMUNICATION SYSTEMS)	
Audible Alarms (See ALARMS)	
Auxiliary Alarms (See ALARMS)	
Emergency Alarms	4.10.12(3), 4.28.3, A4.28.3
Minimum Number: New Construction	4.1.2(13)
Minimum Requirements: Dwelling Units	4.34.2(10)
Postal Facilities: Emergency Signal	9.1
Tactile Warnings on Doors to Hazardous Areas (See TACTILE WARNINGS)	
Visual Alarms (See ALARMS)	
EMPLOYEE PARKING (See PARKING & PASSENGER LOADING ZONES)	
ENTRANCES 4.14	
Accessible Route: Location	4.3.2(1), (3), (4)
Definition of	3.5
Door Hardware (See CONTROLS & OPERATING MECHANISMS)	
Entrances in Dwelling Units (See DWELLING UNITS)	
Health Care Entrances	6.2, 6.3(1)
Historic Preservation: Applicability	4.1.7(1)(b)
Minimum Number: Accessible Housing	4.1.3(2)
Minimum Number: Additions	4.1.5(1), (2)

Factory Industrial Occupancy

ENTRANCES (CONTINUED)

Minimum Number: Alterations 4.1.6(3)(b)
 Minimum Number: Historic Preservation 4.1.7(2)(a), (b), (d)
 Minimum Number: New Construction 4.1.2(1), (7)(a), (8)
 Minimum Number: Sites & Exterior Facilities 4.1.1(1), (7)(c)
 Occupancy Classification: Military Housing 4.1.4(3)
 Parking & Passenger Loading Zones (See PARKING & PASSENGER LOADING ZONES)
 Revolving Doors & Turnstiles (See DOORS)
 Service Entrances 3.5, 4.14.2

EQUIPMENT CATWALKS

Minimum Number: New Construction 4.1.2(5)
 Occupancy Classification: General Exceptions 4.1.4(1)

EQUIPMENT FOR HEARING IMPAIRED (See HEARING IMPAIRED)

ESSENTIAL FEATURES

Definition of 3.5
 Minimum Number: Alterations 4.1.6(1)(a)

EXCEPTIONS

Assembly Areas: Placement of Wheelchair Locations 4.33.3
 Bathrooms, Bathing Facilities & Shower Rooms: Clear Floor Space 4.23.3
 Dwelling Units: Doors 4.34.2(6)
 Dwelling Units: Kitchen Clearances 4.34.6.1
 Highest Operable Part of Controls 4.27.3
 Minimum Number: Accessible Housing: Entrances 4.1.3(2)
 Minimum Number: Additions: Elements & Spaces 4.1.5(4)
 Minimum Number: Alterations: Mechanical Rooms 4.1.6(g)
 Minimum Number: Alterations: Structurally Impracticable 4.1.6(2), (3), (d)
 Minimum Number: Alterations: Toilet Rooms 4.1.6(4)(e)
 Minimum Number: Alterations: Vertical Access 4.1.6(1)(b)
 Minimum Number: Historic Preservation: Entrances 4.1.7(2)(b)
 Minimum Number: Historic Preservation: Slope of Ramps 4.1.7(2)(a)
 Minimum Number: New Construction: Egress 4.1.2(7)
 Minimum Number: New Construction: Elevators 4.1.2(5)
 Minimum Number: New Construction: Temporary Information 4.1.2(15)
 Minimum Number: New Construction: Telephone: Reach Range 4.1.2(16)
 Minimum Number: Sites & Exterior Facilities: Parking Spaces 4.1.1(5)(a)
 Minimum Number: Sites & Exterior Facilities: Toilet Facilities 4.1.1(6)
 Occupancy Classification: General Exceptions 4.1.4(1)
 Parking Spaces 4.6.3
 Shower Stalls: Shower Spray Unit 4.21.6
 Toilet Rooms: Clear Floor Space 4.22.3
 Toilet Stalls 4.17.3
 Visual Alarms 4.28.3(1), (2)

EXITS (See also EGRESS)

Dwelling Units: Exits (See DWELLING UNITS)
 Minimum Number: New Construction 4.1.2(8)
 Doors to Hazardous Areas (See TACTILE WARNINGS)

EXTERIOR (See also SITES & EXTERIOR FACILITIES)

Accessible Route: Location 4.3.2(4)
 Definition of (See Accessible Route, Circulation Path, Common Use, Public Use, Walk) 3.5
 Finding Locations of Buildings A4.30.1
 Historic Preservation: Applicability 4.1.7(1)(b)

EXTERIOR HINGED OR SLIDING DOORS (See DOORS)

EXTRAORDINARY REPAIR

Definition of 3.5

FACILITY (See also Specific Occupancy Classification)

Definition of 3.5

FACTORY INDUSTRIAL OCCUPANCY

Occupancy Classification: Factory Industrial 4.1.4(7)
 Service Entrances (See ENTRANCES)

Faucets

FAUCETS (See also BATHROOMS, BATHING FACILITIES & SHOWER ROOMS)	
Bathubs	4.20.5
Bathubs in Dwelling Units	4.34.5.4(4)
Lavatories & Mirrors	4.19.5
Shower Stalls	4.21.5
Showers in Dwelling Units	4.34.5.5(4)
Sinks	4.24.7
Sinks in Dwelling Units (See SINKS)	
FIRE DOORS (See DOORS)	
FIXED OR BUILT-IN SEATING	
Assembly Areas: Placement of Wheelchair Locations	4.33.3
Assembly Areas: Placement of Listening Systems	4.33.6
Library Seating & Tables	8.2
Minimum Number: New Construction	4.1.2(17)
Restaurants & Cafeterias	5.1
Telephones: Clear Floor or Ground Space	4.31.2
FIXTURES	
Clear Floor Space	4.22.3, 4.23.3, 4.34.5.1
Hall Lantern Fixtures (See ELEVATORS)	
Lavatories & Mirrors (See LAVATORIES & MIRRORS)	
FLOOR SURFACES (See GROUND & FLOOR SURFACES)	
FLUSH CONTROLS (See CONTROLS)	
FOOD SERVICE LINES (See RESTAURANTS & CAFETERIAS)	
FORWARD APPROACH (See REACH RANGES)	
FREE STANDING OBJECTS	
Drinking Fountains & Water Coolers	4.15.5(2)
Protruding Objects	4.4.1
FREEZERS (See KITCHENS)	
FULL & FAIR CASH VALUE	
Definition of	3.5
Minimum Number: Alterations	4.1.6(3)(d)
FUNCTIONAL SPACE	
Definition of	3.5
GATES	
Accessible Gates	4.13.3
Check-out Areas (See LIBRARIES)	
Revolving Doors & Turnstiles (See DOORS)	
Wheelchair Passage Width	A4.2.1(1)
GARAGES (See also PARKING & PASSENGER LOADING ZONES)	
Service Entrances (See ENTRANCES)	
Dwelling Units: Minimum Requirements	4.34.2(15)(d)
Occupancy Classification: Utility & Miscellaneous	4.1.4(13)
Parking Spaces in Garages	A4.6.3
GRAB BARS (See HANDRAILS, GRAB BARS & TUB & SHOWER SEATS)	
GRATINGS (See GROUND & FLOOR SURFACES)	
GRIPPING SURFACES (See HANDRAILS, GRAB BARS & TUB & SHOWER SEATS)	
GROUND & FLOOR SURFACES 4.5, A4.5	
Accessible Route: Surface Textures	4.3.6
Assembly Areas: Surfaces	4.33.4
Carpet (See CARPET)	
Changes in Levels	4.5.2
Clear Floor or Ground Space for Wheelchairs	4.24.3
Curb Ramp Surfaces	4.7.4
Dwelling Units: Minimum Requirements	4.34.2(2)

Hearing Impaired**GROUND & FLOOR SURFACES (CONTINUED)**

Elevators: Floor Surfaces	4.10.10
Gratings	4.5.4
Minimum Number: New Construction	4.1.2(3)
Minimum Number: Sites & Exterior Facilities	4.1.1(4)
Outdoor Ramp Conditions	4.8.8
Outdoor Stairs Conditions	4.9.6
Street & Sidewalk Surfaces	4.5.1, 4.5.4

HALL CALL BUTTONS & LANTERNS (See ELEVATORS)**HAND-HELD SHOWER UNITS (See SHOWER SPRAY UNITS)**

HANDRAILS, GRAB BARS & TUB & SHOWER SEATS	4.26, A4.26
Adaptable Bathrooms	4.34.3, 4.34.4(2), 4.34.5, 4.34.5.2(3), 4.34.5.4(3), 4.34.5.5(3), A4.34.5
Bathtub Grab Bars & Seats	4.20.3, 4.20.4
Bathtubs in Dwelling Units: Seats & Grab Bars	4.34.5.4(2), (3)
Eliminating Hazards	4.26.4
Gripping Surfaces	4.8.5(4), 4.9.4(4), (5), 4.17.6, 4.26.2
Handrails at Ramps	4.8.5, A4.8.5
Handrails for Stairs	4.9.4, A4.8.5
Minimum Number: Alterations	4.1.6(4)(b)
Minimum Number: Dwelling Units	4.34.2(12), 4.34.5, 4.34.5.2(3), 4.34.5.4, 4.34.5.5
Minimum Number: Grab Bars	4.16.1, 4.16.4, 4.17.1, 4.17.6, 4.20.1, 4.20.4, 4.21.1, 4.21.4
Minimum Number: Handrails	4.8.1, 4.8.5, 4.9.1, 4.9.4
Minimum Number: Shower Seats	4.20.1, 4.20.3, 4.21.1, 4.21.3
Post Office Lobby Handrails	9.2(2)
Shower Stalls: Seats & Grab Bars	4.21.3, 4.21.4
Showers in Dwelling Units	4.34.5.5(2), (3)
Size & Spacing of Grab Bars & Handrails	4.26.2, A4.26.2
Structural Strength	4.26.3
Toilet Stalls: Grab Bars	4.17.6
Water Closet Grab Bars	4.16.4, A4.16.4
Water Closets in Dwelling Units: Grab Bars	4.34.5.2(3)

HARDWARE (See CONTROLS & OPERATING MECHANISMS)**HAZARDOUS AREAS (See TACTILE WARNINGS)****HAZARDOUS VEHICULAR AREAS (See TACTILE WARNINGS)****HAZARDOUS OCCUPANCY**

Occupancy Classification: Factory Industrial	4.1.4(7)
Occupancy Classification: Hazardous	4.1.4(8)
Occupancy Classification: Storage	4.1.4(12)

HEAD ROOM

Accessible Route	4.3.5
Protruding Objects	4.4.2

HEALTH CARE

Doors to Patient Bedrooms (See DOORS)	
Entrances (See ENTRANCES)	
Entry Doors to Acute Care Hospital Rooms (See DOORS)	
Hospitals	4.1.4(9)(b), 4.13.6
Long-term Care Facilities	4.1.4(9)
Minimum Number: New Construction	4.1.2(13)
Minimum Number: Sites & Exterior Facilities	4.1.1(5)(e)
Occupancy Classification: Business	4.1.4(5)
Occupancy Classification: Institutional	4.1.4(9), (a), (b)
Outpatient Facilities	4.1.1(5)(e), 4.1.4(5), (9)(b)
Patient Bedrooms	6.3
Patient Toilet Rooms	6.4

HEARING IMPAIRED

Auxiliary Alarms (See ALARMS)	
Dwelling Unit: Consumer Information	4.34.4(3), (4)
Equipment for Hearing Impaired	4.28.2, 4.28.3, 4.28.4, 4.31.5, 4.34.4(3), (4), A4.31.5
Listening Systems (See LISTENING SYSTEMS)	
Minimum Number: New Construction	4.1.2(16)(b), (18)(b)

Hearing Impaired**HEARING IMPAIRED (CONTINUED)**

Telephones	4.31.5, A4.31.5
Visual Alarms (See ALARMS)	
HINGED DOOR (See DOORS)	
HISTORIC PRESERVATION	4.17
HOSPITALS (See HEALTH CARE)	
HOUSING (See also DWELLING UNITS)	
Definition of	3.5
Minimum Number: Additions (Reserved)	4.1.5(5)
Minimum Number: Housing	4.1.3
Minimum Number: Sites & Exterior Facilities	4.1.1(5)(d)
Occupancy Classification: Military Exclusions	4.1.4(2)(a)
Occupancy Classification: Military Housing	4.1.4(3)
Occupancy Classification: Residential	4.1.4(11)
ILLUMINATION LEVELS (See ELEVATORS: SIGNAGE)	
INCISED & INDENTED CHARACTERS (See SIGNAGE)	
INSTITUTIONAL OCCUPANCY	
Occupancy Classification: Institutional	4.1.4(9)
Occupancy Classification: Residential	4.1.4(11)
INTERCOMMUNICATION SYSTEMS (See EMERGENCY COMMUNICATION SYSTEMS)	
INTERNATIONAL SYMBOL OF ACCESSIBILITY	
Minimum Number: Sites & Exterior Facilities	4.1.1(7)
Parking & Passenger Loading Zones: Signage (See PARKING & PASSENGER LOADING ZONES)	
Symbol of Accessibility	4.30.5
INTERSECTIONS (See CURB RAMPS)	
INTERIOR HINGED DOORS (See DOORS)	
INTERIOR SIGNAGE MOUNTING HEIGHT & LOCATIONS (See SIGNAGE)	
JAILS (See CORRECTIONAL FACILITIES)	
KITCHENS (See also DWELLING UNITS)	4.34.6, A4.34.6
Adaptable Features: Consumer Information	4.34.4(1), (3), (4)
Base Cabinets	4.34.4(1),(3),(4), 4.34.6.1, 4.34.6.4(2), 4.34.6.10(2), A4.34.6.5(5), A4.34.6.10
Cabinets	4.34.2(8), 4.34.4(1),(3),(4), 4.34.6.10
Clear Floor Space	4.34.6.2
Clearance	4.34.6.1, A4.34.6.1
Controls (See CONTROLS & OPERATING MECHANISMS)	
Counter Work Surfaces	4.34.6.4
Dishwashers	4.34.6.2, 4.34.6.9
Height of Work Surfaces	4.34.4(1), (4), 4.34.6.4, (1)
Kitchen Storage	4.34.6.10, (1), (2), A4.34.6.10
Minimum Requirements	4.34.2(13), 4.34.6
Ovens	4.34.6.6, 4.34.6.7, A4.34.6.7
Ranges/Cooktops	4.34.6.2, 4.34.6.6, A4.34.6.6
Refrigerator/Freezers	4.34.6.2, 4.34.6.8, (1),(2), A4.34.6.8
Sinks (See SINKS)	
KITCHEN STORAGE (See KITCHENS)	
KNEE & TOE CLEARANCES	
Clear Knee Space	4.2.4.1, 4.15.5, (1)
Drinking Fountains: Knee Clearance	4.15.5(1)
Lavatories & Mirrors	4.19.2
Seating, Tables & Work Surfaces	4.32.2, 4.32.3
Sinks: Knee Clearance	4.24.3
Sinks: Knee Clearance in Dwelling Units	4.34.6.5(7), A4.34.6.5
Toilet Stalls: Toe Clearance	4.17.4
KNURLING (See TACTILE WARNINGS)	

Military

LANDINGS (See RAMPS)	
LAUNDRY FACILITIES (See DWELLING UNITS)	
LAVATORIES & MIRRORS	4.19, A4.19
Adaptability: Consumer Information	4.34.4(1)
Built-in Lavatories	4.19.1
Bathrooms, Bathing Facilities & Shower Rooms: Clear Floor Space	4.23.3
Clear Floor Space	4.19.3
Dwelling Units: Lavatory, Mirrors & Medicine Cabinets	4.34.5.3
Exposed Pipes & Surfaces	4.19.4
Faucets (See FAUCETS)	
Height & Clearances	4.19.2
Knee & Toe Clearances (See KNEE & TOE CLEARANCES)	
Lavatory Fixtures	4.19.5, 4.22.3, 4.23.3
Lavatory Height	4.19.2
Lavatory Vanities	4.19.1
Minimum Number: Alterations	4.1.6(4)(e)
Minimum Number: Lavatories & Mirrors	4.19.1, 4.22.6, 4.23.6
Minimum Requirements: Dwelling Units	4.34.2(12)
Mirrors	4.1.4(12), 4.19.6, A4.19.6
Toilet Rooms	4.22.6
LIBRARIES	8.
Card Catalogs	8.4
Check-out Areas	8.3
Minimum Number	8.1, 8.2
Public Toilet Rooms (See TOILET ROOMS)	
Occupancy Classification: Assembly	4.1.4(4)
Reading & Study Areas	8.1.2
Stacks	8.1, 8.4, 8.5
LIFTS (See PLATFORM LIFTS)	
LISTENING SYSTEMS (See also AUDIO-AMPLIFICATION SYSTEMS)	
Minimum Number: New Construction	4.1.2(18)(b)
Placement of Listening Systems	4.33.6, A4.33.6
Types of Listening Systems	4.33.7, A4.33.7
LIVING ROOMS (See DWELLING UNITS)	
LOCKER ROOMS (See PERFORMING AREAS; POSTAL FACILITIES)	
LONG-TERM CARE FACILITIES (See HEALTH CARE)	
MANEUVERING CLEARANCES AT DOORS (See DOORS)	
MARKED CROSSINGS (See CURB RAMPS)	
MECHANICAL ROOMS	
Minimum Number: Additions	4.1.5(4)
Minimum Number: Alterations	4.1.6(1)(g)
Minimum Number: New Construction	4.1.2(5)
Occupancy Classification: General Exceptions	4.1.4(1)
MEDICINE CABINETS (See BATHROOMS, BATHING FACILITIES & SHOWER ROOMS; DWELLING UNITS)	
MEETING ROOMS (See ASSEMBLY AREAS)	
MERCANTILE	7.
Check-out Aisles	7.3
Minimum Number: New Construction	7.1
Occupancy Classification: Mercantile	4.1.4(10)
Security Bollards (See EGRESS)	
Service Counters	7.2
MERCANTILE OCCUPANCY	4.1.4(10)
MILITARY	
Occupancy Classification: Military Exclusions	4.1.4(2), (a), (b), (c)
Occupancy Classification: Military Housing	4.1.4(3)

Minimum Number

MINIMUM NUMBER (See also MINIMUM REQUIREMENTS)	4.1
Minimum Number: Additions	4.1.5
Minimum Number: Alterations	4.1.6
Minimum Number: Bathing & Shower Facilities	4.2.3.8
Minimum Number: Controls & Dispensers	4.2.2.7, 4.2.3.7
Minimum Number: Historic Preservation	4.1.7
Minimum Number: Housing	4.1.3
Minimum Number: Lavatories & Mirrors	4.2.2.6, 4.2.3.6
Minimum Number: Medicine Cabinets	4.2.3.9
Minimum Number: New Construction	4.1.2
Minimum Number: Sites & Exterior Facilities	4.1.1
Minimum Number: Urinals	4.2.2.5, 4.2.3.5
Minimum Number: Water Closets	4.2.2.4, 4.2.3.4
MINIMUM REQUIREMENTS (See DWELLING UNITS; KITCHENS)	
MIRRORS (See LAVATORIES & MIRRORS)	
MULTI-STORY BUILDING	
Minimum Number: New Construction	4.1.2(5)
NEW CONSTRUCTION	
Minimum Number: New Construction	4.1.2
Minimum Number: Sites & Exterior Facilities	4.1.1
Minimum Slope of Ramps: New Construction	4.8.2
NOSINGS (See STAIRS)	
OCCUPANCY CLASSIFICATIONS (See also Specific Classification)	4.1.4
OUTDOOR RAMPS (See RAMPS)	
OUTDOOR STAIRS (See STAIRS)	
OUTPATIENT FACILITIES (See HEALTH CARE)	
OVENS (See KITCHENS)	
PARALLEL APPROACH (See REACH RANGES)	
PARKING & PASSENGER LOADING ZONES	4.6, A4.6
Accessible Route Locations	4.3.2(1)
Employee Parking: Minimum Number	4.1.1(5)(a), (e), (1), (3)
Entrances	4.6.2, 4.6.3, 4.14.1
Health Care	6.2
Historic Preservation: Applicability	4.1.7(1)(b)
Libraries	8.1
Location	4.6.2
Minimum Number: Alterations:	4.1.6(3)(d)(i)
Minimum Number: New Construction	4.1.2(8)
Minimum Number: Sites & Exterior Facilities:	4.1.1(1), (5)
Minimum Requirements: Parking in Dwelling Units	4.34.2(4)
Occupancy Classification: Military Exclusions: Parking	4.1.4(2)(c)
Occupancy Classification: Military Housing: Parking	4.1.4(3)
Parking Lots: Minimum Number	4.1.1(5)(a)
Parking Spaces	4.1.1(1), (7)(a), 4.6.3, A4.6.3
Parking Spaces: Minimum Number	4.1.1, (5)(a), (c), (d), (i)(ii), (e), (i)(ii)(iii), 7(a)
Passenger Loading Zones	4.1.1(1), (7)(b), 4.6.5
Passenger Loading Zones: Minimum Number	4.1.1(5)(b)
Signage	4.6.4
Vertical Clearance	4.6.6
Visitor Parking: Minimum Number	4.1.1(5)(a), (d)(3), (e)
PASSING SPACE (See CLEARANCES FOR WHEELCHAIRS)	
PATIENT BEDROOMS (See HEALTH CARE)	
PATIOS (See DWELLING UNITS)	
PERFORMING AREAS	
Access to Performing Arts	4.33.5
Dressing Rooms	4.33.5

Reach Ranges

PERFORMING AREAS (CONTINUED)	
Minimum Number	4.33.1
Minimum Number: Alterations	4.1.6(4)(1)(ii)
Stages	4.29.3, 4.33.5
PHYSICALLY HANDICAPPED	
Definition of	3.5
PLATFORM LIFTS	
Accessible Route: Changes in Levels	4.10.1
Minimum Number: Alterations	4.1.6(b)
Minimum Number: New Construction	4.1.2(5)
Wheelchair Lifts	4.10.1
POSTAL FACILITIES	
Attendance-Recording Equipment	9.6
Employee Toilet Rooms (See TOILET ROOMS)	
Handrails (See HANDRAILS, GRAB BARS & TUB & SHOWER SEATS)	
Letter Drops, Customer Service Desks, Tables or Counters	9.2
Locker Rooms	9.5
Post Office Boxes	9.4
Post Office Lobbies	9.2
Self-Service Postal Centers	9.3
Switches & Controls (See CONTROLS & OPERATING MECHANISMS)	
POWER-ASSISTED DOORS (See DOORS)	
PRISONS (See CORRECTIONAL FACILITIES)	
PROTRUDING OBJECTS	
Head Room	4.4.2
Minimum Number: New Construction	4.1.2(2)
Minimum Number: Sites & Exterior Facilities	4.1.1(3)
Telephones	4.31.4
PUBLIC TELEPHONES (See TELEPHONES)	
PUBLIC STREETS & SIDEWALKS (See STREETS & SIDEWALKS)	
RAISED CHARACTERS (See SIGNAGE)	
RAMPS (See also CURB RAMPS)	
Accessible Routes: Changes in levels	4.3.8
Accessible Routes: Sites	A4.3.1(2)
Clear Width	4.8.3
Cross Slope	3.5, 4.3.7, 4.8.6, A4.5.1
Definition of	3.5
Edge Protection	4.8.7
Handrails (See HANDRAILS, GRAB BARS & TUB & SHOWER SEATS)	
Historic Preservation: Applicability	4.1.7(1)(b)
Landings	4.8.4, 4.8.7
Minimum Number: Alterations	4.1.6(1)(b)
Minimum Number: Historic Preservation	4.1.7(2)(a)
Minimum Number: New Construction	4.1.2(5)
Outdoor Conditions	4.8.8
Running Slope	3.5, 4.3.7, A4.3.1(2)
Rise	4.8.2, 4.8.5, A4.8.2
Slopes	4.1.6(4)(a), 4.1.7(2)(a), 4.5.2, 4.6.3, 4.6.5
Surfaces (See GROUND & FLOOR SURFACES)	
RANGES/COOKTOPS (See KITCHENS)	
REACH RANGES	
Forward Approach (See also Approach to Specific Element)	4.2.4.1, 4.2.5
Forward Reach	4.2.5, A4.2.5
Minimum Number: New Construction: Reach Ranges	4.1.2(16)(a)
Parallel Approach (See also Approach to Specific Element)	4.2.4.1, 4.2.6
Reach Obstructions	4.2.5, 4.2.6
Side Reach	4.2.6

Reading & Study Areas

READING & STUDY AREAS (See LIBRARIES)

RECESSED CHARACTERS (See ELEVATORS)

REFLECTING POOLS (See TACTILE WARNINGS)

REFRIGERATOR/FREEZERS (See KITCHENS)

RESIDENTIAL OCCUPANCY 4.1.4(11)

RESTAURANTS/CAFETERIAS 5.

 Displays (See DISPLAYS)

 Food Service Lines 5.2

 Minimum Number 5.1

 Occupancy Classification: Assembly 4.1.4(4)

 Tableware Areas 5.3

 Vending Machines 5.4

REVOLVING DOORS & TURNSTILES (See DOORS)

RISE (See RAMPS)

RUNNING SLOPE (See RAMPS)

SEATS (See FIXED OR BUILT-IN SEATING; SEATING, TABLES & WORK SURFACES; HANDRAILS, GRAB BARS, TUB & SHOWER SEATS)

SEATING SPACES (See also FIXED OR BUILT-IN SEATING; SEATING, TABLES & WORK SURFACES)

SEATING, TABLES & WORK SURFACES (See FIXED OR BUILT-IN SEATING) 4.32, A4.32

 Bathub Seats (See HANDRAILS, GRAB BARS & TUB & SHOWER SEATS)

 Bathub Seats in Dwelling Units (See DWELLING UNITS)

 Counter Work Surfaces in Kitchens (See KITCHENS)

 Fixed Seats for Telephones (See TELEPHONES)

 Letter Drops, Customer Service Desks, Tables or Counters (See POSTAL FACILITIES)

 Height of Work Surfaces 4.32.4, A4.32.4

 Knee Clearance (See KNEE & TOE CLEARANCES)

 Library Seating & Tables 8.2

 Minimum Number: Alterations 4.1.6(3)(d)(vi), (4)(f)(i)

 Minimum Number: New Construction 4.1.2(17), (18)

 Placement of Wheelchairs in Seating Areas (See ASSEMBLY AREAS)

 Ranges & Cooktop Surfaces (See KITCHENS)

 Restaurant Seating 5.1

 Seating Spaces 4.32.2

 Shower Seats (See HANDRAILS, GRAB BARS & TUB & SHOWER SEATS)

 Shower Seats in Dwelling Units (See DWELLING UNITS)

SECURITY BOLLARDS (See EGRESS)

SELF-SERVICE POSTAL CENTERS (See POSTAL FACILITIES)

SERVICE COUNTERS (See MERCANTILE)

SERVICE ENTRANCES (See ENTRANCES)

SHOWER FACILITIES/SHOWERS (See BATHROOMS, BATHING FACILITIES & SHOWER ROOMS; DWELLING UNITS)

SHOWER SPRAY UNITS

 Bathubs: Fixed or Hand-held Shower Units 4.20.6

 Dwelling Units: Fixed or Hand-held Shower Units 4.34.5.4(5), 4.34.5.5(5)

 Shower Stalls: Fixed or Hand-held Shower Units 4.21.6

SHOWER STALLS 4.21

 Controls (See CONTROLS & OPERATING MECHANISMS)

 Curbs in Shower Stalls 4.21.7, A4.21.1

 Handrails (See HANDRAILS, GRAB BARS & TUB & SHOWER SEATS)

 Shower Enclosures 4.21.8

 Shower Seats (See HANDRAILS, GRAB BARS & TUB & SHOWER SEATS)

SIDE REACH (See REACH RANGES)

SIDES OF CURB RAMPS (See CURB RAMPS)

SIDEWALKS (See STREETS & SIDEWALKS)

Storage

SIGNAGE	4.30, A4.30
Character Proportion	4.10.5, 4.30.2, 4.30.4, A4.30.2, A4.30.4
Color Contrast	4.30.3, A4.30.3
Definition of	3.5
Directional Signs	4.1.7(2)(b)
Historic Preservation: Applicability	4.1.7(1)(b)
Incised or Raised Characters	4.30.4, A4.30.4
Indented Characters	4.30.4, A4.30.4
Interior Signage Mounting Height	4.1.7(2)(e), 4.30.6
Interior Signage Mounting Locations	4.1.2(15), (16), 4.1.7(2)(e), 4.30.6, A4.30.1
Illumination Levels	A4.30.1
Minimum Number: Historic Preservation	4.1.7(2)(b),(e)
Minimum Number: New Construction	4.1.2(15), (16)(a)
Parking & Passenger Loading Zones: Signage	4.6.4
Stroke Width	4.30.2, 4.30.4, A4.30.2
Symbol of Accessibility (See INTERNATIONAL SYMBOL OF ACCESSIBILITY)	
SINKS	4.24
Adaptability: Consumer Information	4.34.4(1), (4), (5)
Clear Floor Space	4.24.5
Depth of Sink Bowl	4.24.4, 4.34.6.5(3)
Exposed Pipes & Surfaces	4.24.6
Faucets (See FAUCETS)	
Height	4.24.2, 4.34.4(1), (5), 4.34.6.5(1)
Sinks in Dwelling Units	4.34.6.5, A4.34.6.1, 5
Sink Knee Clearance (See KNEE & TOE CLEARANCES)	
SITES & EXTERIOR FACILITIES	4.1.1
Definition of (See Site)	3.5
SLEEPING AREAS (See DWELLING UNITS)	
SLEEPING ACCOMMODATIONS (See also DWELLING UNITS; HEALTH CARE)	
Auxiliary Alarms (See ALARMS)	
Minimum Number: New Construction	4.1.2(13)
Occupancy Classification: Residential	4.1.4(11)
SLIDING DOORS (See DOORS)	
SLOPES (See RAMPS)	
SPACES (See ELEMENTS & SPACES)	
STACKS (See LIBRARIES)	
STAGES (See PERFORMING AREAS)	
STAIRS	4.9
Accessible Route: Changes in Levels	4.3.8
Ground & Floor Surfaces	4.5.1, A4.5.1
Handrails (See HANDRAILS, GRAB BARS & TUB & SHOWER SEATS)	
Minimum Number: Alterations	4.1.6(1)(b), (d), (4)(b)
Minimum Number: New Construction	4.1.2(4)
Nosings	4.9.3
Outdoor Stairs	4.9.6
Ramps: General	A4.8.1, A4.8.5
Risers	4.9.2, 4.9.3, 4.9.4(2)
Steps	4.9.2
Tactile Warnings at Stairs (See TACTILE WARNINGS)	
Treads	4.9.2
STEPS (See STAIRS)	
STORAGE	4.25
Clothes Rods	4.25.3
Clear Floor Space	4.25.2
Fixed Storage Facilities	4.25.1
Height	4.25.3
Hardware (See CONTROLS & OPERATING MECHANISMS)	
Kitchen Storage (See KITCHENS)	

Storage**STORAGE (CONTINUED)**

Minimum Number: Additions	4.1.5(4)
Minimum Number: Alterations	4.1.6(3)(d)(iii)
Minimum Number: New Construction	4.1.2(11)
Occupancy Classification: Business	4.1.4(5)
Occupancy Classification: Hazardous	4.1.4(8)
Occupancy Classification: Storage	4.1.4(12)
Storage Cabinets	4.1.2(11), 4.1.4(12), 4.25.1
Storage in Dwelling Units (See DWELLING UNITS)	

STORAGE OCCUPANCY	4.1.4(12)
--------------------------------	-----------

STREETS & SIDEWALKS

Accessible Route: General	4.3.1
Accessible Route: Location	4.3.2(1)
Curb Ramps: Islands	4.7.11
Curb Ramp Transitions	4.7.2
Definition of (See Common Use, Public Use, Vehicular Way, Walk)	3.5
Entrances	4.1.4.1
Gratings	4.5.4
Minimum Number: New Construction	4.1.2(8)
Minimum Number: Sites & Exterior Facilities	4.1.1(1)
Minimum Requirements: Dwelling Units	4.34.2(1)
Occupancy Classification: Military Housing	4.1.4(3)
Outdoor Conditions	4.8.8, 4.9.6
Tactile Warnings on Walking Surfaces (See TACTILE WARNINGS)	
Surfaces (See GROUND & FLOOR SURFACES)	
Walks	4.3.4

STROKE WIDTH (See SIGNAGE)**STRUCTURALLY IMPRACTICABLE/STRUCTURAL IMPRACTICABILITY**

Definition of	3.5
Minimum Number: Alterations	4.1.6(2),(3), (4)(c)(ii), (e), (f)(i), (ii)
Toilet Stalls: Exception	4.17.3

STRUCTURAL REINFORCEMENT (See DWELLING UNITS)**STRUCTURAL STRENGTH (See HANDRAILS, GRAB BARS & TUB & SHOWER SEATS)****SURFACE TEXTURES (See TACTILE WARNINGS)****SYMBOL OF ACCESSIBILITY (See INTERNATIONAL SYMBOL OF ACCESSIBILITY)****TABLES (See SEATING, TABLES & WORK SURFACES)****TABLEWARE AREAS (See RESTAURANTS)****TACTILE CONTROL INDICATORS (See ELEVATORS)**

TACTILE WARNINGS	4.2.9
-------------------------------	-------

Definition of (See also Tactile)	3.5
Elevators: Tactile & Visual Control Indicators	4.10.12(2)
Knurling	4.29.3
Minimum Number: New Construction	4.1.2(14)
Tactile Warnings at Hazardous Vehicular Areas (Reserved)	4.29.5, 4.29.5
Tactile Warnings at Reflecting Pools (Reserved)	4.29.6
Tactile Warnings at Stairs (Reserved)	4.9.5, 4.29.4
Tactile Warnings on Doors to Hazardous Areas	4.29.3, 4.29.7
Tactile Warnings on Walking Surfaces (Reserved)	4.29.7
Textured Surfaces	4.29.3, 4.29.7
Warning Textures on Curb Ramps (Reserved)	4.7.7

TAXI STANDS

Minimum Number: New Construction	4.1.2(8)
--	----------

TELEPHONES 4.3.1

Clear Floor Space	4.31.2
Fixed Seats	4.31.2
Mounting Height of Operable Equipment	4.31.3, 4.31.3
Minimum Number: Alterations	4.1.6(3)(d)(v)

Urinals

TELEPHONES (CONTINUED)	
Minimum Number: New Construction	4.1.2(16)
Occupancy Classification: Business	4.1.4(5)
Occupancy Classification: General Exceptions	4.1.4(1)
Protruding Objects	4.4.1
Public Telephones	4.1.2(16), 4.31.1
Push Button Controls	4.31.1
Telephone Banks	4.1.2(16)(a)
Telephone Books/Directories	4.31.7
Telephone Cord Length	4.31.8
Telephone Cord Length in Elevators	4.10.14
Volume Controls	4.1.2(16) (b), 4.31.5, A4.33.7
TELEPHONE BANKS (See TELEPHONES)	
TERRACES (See DWELLING UNITS)	
TRAFFIC ISLANDS (See CURB RAMPS)	
THRESHOLDS AT DOORWAYS (See DOORS)	
TOE CLEARANCE (See KNEE & TOE CLEARANCES)	
TOILET FACILITIES (See TOILET ROOMS)	
TOILET ROOMS	4.22
Bathrooms in Dwelling Units (See DWELLING UNITS)	
Clear Floor Space	4.22.3
Controls (See CONTROLS & OPERATING MECHANISMS)	
Doors (See DOORS)	
Employee Toilet Rooms: Postal Facilities	9.1
Historic Preservation: Applicability	4.1.7(1)(b)
Lavatories & Mirrors (See LAVATORIES & MIRRORS)	
Minimum Number: Additions	4.1.5(3)
Minimum Number: Alterations	4.1.6(3)(c)(i), (ii), (4)(e)
Minimum Number: Historic Preservation	4.1.7(2)(c)
Minimum Number: New Construction	4.1.2(10)
Minimum Number: Sites & Exterior Facilities	4.1.1(6), (7)
Patent Toilet Rooms (See HEALTH CARE)	
Public Toilet Rooms: Libraries	8.1
Unisex Toilets	4.1.6(4)(e), 4.1.7(2)(c)
Urinals (See URINALS)	
Water Closets (See WATER CLOSETS)	
TOILET STALL (See also DOORS)	4.17, A4.17
Grab Bars (See HANDRAILS, GRAB BARS & TUB & SHOWER SEATS)	
Toilet Stall Doors (See DOORS)	
Toilet Stalls in Bathrooms, Bathing Facilities & Shower Rooms	4.23.4
Toe Clearance (See KNEE & TOE CLEARANCES)	
Seats (See HANDRAILS, GRAB BARS & TUB & SHOWER SEATS)	
Water Closets in Toilet Stalls	4.16, 4.17.2, 4.22.4
TRANSIT FACILITIES	
Minimum Number: Alterations: Transit Facilities	4.1.6(1)(b)
Minimum Number: New Construction	4.1.2(8)
TREADS (See STAIRS)	
TURNSTILES (See DOORS)	
UNCURBED INTERSECTIONS (See CURB RAMPS)	
UNOBSTRUCTED TURNING SPACES (See CLEARANCES FOR WHEELCHAIRS)	
URINALS	4.18
Clear Floor Space	4.18.3
Controls (See CONTROLS & OPERATING MECHANISMS)	
Height	4.18.2
Minimum Number: Bathrooms, Bathing Facilities & Shower Rooms	4.23.5
Minimum Number: Toilet Rooms	4.22.5
Shields	4.18.3
Urinals in Toilet Rooms	4.22.5

Utility & Miscellaneous Occupancy

UTILITY & MISCELLANEOUS OCCUPANCY	4.1.4(13)
VANITIES (See LAVATORIES & MIRRORS)	
VANS	
Parking Spaces	4.1.1(5)(c), 4.6.3, A4.6.3
Vertical Clearance	4.6.6
VEHICULAR AREAS/WAYS	
Definition of (See also Marked Crossing, Site Improvement)	3.5
Built-up Curb Ramp Location (See CURB RAMPS)	
Tactile Warnings at Hazardous Vehicular Areas (See TACTILE WARNINGS)	
VENDING MACHINES (See RESTAURANTS; POSTAL FACILITIES)	
VERTICAL ACCESS	
Definition of (See Entrance)	3.5
Minimum Number: Alterations	4.1.6(b)
Minimum Number: New Construction	4.1.2(8)
Vertical Access Equipment	4.1.6(b)
VERTICAL CLEARANCE (See PARKING & PASSENGER LOADING ZONES)	
VISITOR PARKING (See PARKING & PASSENGER LOADING ZONES)	
VISUAL ALARMS (See ALARMS)	
VISUAL CONTROL INDICATORS (See ELEVATORS)	
VOLUME CONTROLS (See TELEPHONES)	
WALKS (See STREETS & SIDEWALKS)	
WARNING TEXTURES (See TACTILE WARNINGS)	
WASHING MACHINES (See DWELLING UNITS)	
WATER CLOSETS	4.1.6, A4.1.6
Bathrooms, Bathing Facilities & Shower Rooms with Water Closets	4.23.2, 4.23.4
Clear Floor Space	4.1.6.2
Controls (See CONTROLS & OPERATING MECHANISMS)	
Floor-mounted Water Closets	4.1.7.3
Grab Bars (See HANDRAILS, GRAB BARS & TUB & SHOWER SEATS)	
Height of Water Closets	4.1.6.3, 4.1.7.3, A4.1.6.3
Minimum Number: Alterations	4.1.6(4)(e)
Seats (See HANDRAILS, GRAB BARS & TUB & SHOWER SEATS)	
Toilet Rooms with Water Closets	4.22.3, 4.22.4
Toilet Stalls with Water Closets	4.1.7.2, 4.1.7.3
Wall-mounted Water Closets	4.1.7.3
Water Closets in Dwelling Units (See DWELLING UNITS)	
WHEELCHAIR LIFTS (See PLATFORM LIFTS)	
WHEELCHAIR MANEUVERING, PASSING & TURNING CLEARANCES (See CLEARANCES FOR WHEELCHAIRS)	
WINDOWS (Reserved)	4.1.2
WORK SURFACES (See SEATING, TABLES & WORK SURFACES)	

**Subparts 101-19.7—101-19.47
[Reserved]**

Subpart 101-19.48—Exhibits

§ 101-19.4800 Scope of subpart.

This subpart 101-19.48 illustrates information referred to in the text of part 101-19 but not suitable for inclusion elsewhere in that part.

§ 101-19.4801 Memorandum of understanding between the Department of Housing and Urban Development and the General Services Administration concerning low- and moderate-income housing.

MEMORANDUM OF UNDERSTANDING BETWEEN THE DEPARTMENT OF HOUSING AND URBAN DEVELOPMENT AND THE GENERAL SERVICES ADMINISTRATION CONCERNING LOW- AND MODERATE-INCOME HOUSING

Purpose. The purpose of the memorandum of understanding is to provide an effective, systematic arrangement under which the Federal Government, acting through HUD and GSA, will fulfill its responsibilities under law, and as a major employer, in accordance with the concepts of good management, to assure for its employees the availability of low- and moderate-income housing without discrimination because of race, color, religion, or national origin, and to consider the need for development and redevelopment of areas and the development of new communities and the impact on improving social and economic conditions in the area, whenever Federal Government facilities locate or relocate at new sites, and to use its resources and authority to aid in the achievement of these objectives.

1. Title VIII of the Civil Rights Act of 1968 (42 U.S.C. 3601) states, in section 801, that "It is the policy of the United States to provide, within constitutional limitations, for fair housing throughout the United States." Section 808(a) places the authority and responsibility for administering the Act in the Secretary of Housing and Urban Development. Section 808(d) requires all executive departments and agencies to administer their programs and activities relating to housing and urban development in a manner affirmatively to further the purposes of title VIII (fair housing) and to cooperate with the Secretary to further such purposes. Section 808(e)(5) provides that the Secretary of HUD shall administer the programs and activities relating to housing and urban development in a manner affirmatively to further the policies of title VIII.

2. Section 2 of the Housing Act of 1949 (42 U.S.C. 1441) declares the national policy of

"* * * the realization as soon as feasible of the goal of a decent home and a suitable living environment for every American family * * *." This goal was reaffirmed in the Housing and Urban Development Act of 1968 (sections 2 and 1601; 12 U.S.C. 1701t and 42 U.S.C. 1441a).

3. By virtue of the Public Buildings Act of 1959, as amended; the Federal Property and Administrative Services Act of 1949, as amended; and Reorganization Plan No. 18 of 1950, the Administrator of General Services is given certain authority and responsibility in connection with planning, developing, and constructing Government-owned public buildings for housing Federal agencies, and for acquiring leased space for Federal agency use.

4. Executive Order 11512, February 27, 1970, sets forth the policies by which the Administrator of General Services and the heads of executive agencies will be guided in the acquisition of both federally owned and leased office buildings and space.

5. While Executive Order No. 11512 provides that material consideration will be given to the efficient performance of the missions and programs of the executive agencies and the nature and functions of the facilities involved, there are six other guidelines set forth, including:

The need for development and redevelopment of areas and the development of new communities, and the impact a selection will have on improving social and economic conditions in the area; and

The availability of adequate low- and moderate-income housing, adequate access from other areas of the urban center, and adequacy of parking.

6. General Services Administration (GSA) recognizes its responsibility, in all its determinations with respect to the construction of Federal buildings and the acquisition of leased space, to consider to the maximum possible extent the availability of low- and moderate-income housing without discrimination because of race, color, religion, or national origin, in accordance with its duty affirmatively to further the purposes of title VIII of the Civil Rights Act of 1968 and with the authorities referred to in paragraph 2 above, and the guidelines referred to in paragraph 5 above, and consistent with the authorities cited in paragraphs 3 and 4 above. In connection with the foregoing statement, it is recognized that all the guidelines must be considered in each case, with the ultimate decision to be made by the Administrator of General Services upon his determination that such decision will improve the management and administration of governmental activities and services, and will foster the programs and policies of the Federal Government.

7. In addition to its fair housing responsibilities, the responsibilities of HUD include

Federal Property Management Regulations

§ 101-19.4801

assisting in the development of the Nation's housing supply through programs of mortgage insurance, home ownership and rental housing assistance, rent supplements, below market interest rates, and low-rent public housing. Additional HUD program responsibilities which relate or impinge upon housing and community development include comprehensive planning assistance, metropolitan area planning coordination, new communities, relocation, urban renewal, model cities, rehabilitation loans and grants, neighborhood facilities grants, water and sewer grants, open space, public facilities loans, Operation BREAKTHROUGH, code enforcement, workable programs, and others.

8. In view of its responsibilities described in paragraphs 1 and 7 above, HUD possesses the necessary expertise to investigate, determine, and report to GSA on the availability of low- and moderate-income housing on a nondiscriminatory basis and to make findings as to such availability with respect to proposed locations for a federally-constructed building or leased space which would be consistent with such reports. HUD also possesses the necessary expertise to advise GSA and other Federal agencies with respect to actions which would increase the availability of low- and moderate-income housing on a nondiscriminatory basis, once a site has been selected for a federally-constructed building or a lease executed for space, as well as to assist in increasing the availability of such housing through its own programs such as those described in paragraph 7 above.

9. HUD and GSA agree that:

(a) GSA will pursue the achievement of low- and moderate-income housing objectives and fair housing objectives, in accordance with its responsibilities recognized in paragraph 6 above, in all determinations, tentative and final, with respect to the location of both federally constructed buildings and leased buildings and space, and will make all reasonable efforts to make this policy known to all persons, organizations, agencies and others concerned with federally owned and leased buildings and space in a manner which will aid in achieving such objectives.

(b) In view of the importance to the achievement of the objectives of this memorandum of agreement of the initial selection of a city or delineation of a general area for location of public buildings or leased space, GSA will provide the earliest possible notice to HUD of information with respect to such decisions so that HUD can carry out its responsibilities under this memorandum of agreement as effectively as possible.

(c) Government-owned Public Buildings Projects:

(1) In the planning for each new public buildings project under the Public Buildings Act of 1959, during the survey preliminary to

the preparation and submission of a project development report, representatives of the regional office of GSA in which the project is proposed will consult with, and receive advice from, the regional office of HUD, and local planning and housing authorities concerning the present and planned availability of low- and moderate-income housing on a nondiscriminatory basis in the area where the project is to be located. Such advice will constitute the principal basis for GSA's consideration of the availability of such housing in accordance with paragraphs 6 and 9(a). A copy of the prospectus for each project which is authorized by the Committees on Public Works of the Congress in accordance with the requirements of section 7(a) of the Public Buildings Act of 1959, will be provided to HUD.

(2) When a site investigation for an authorized public buildings project is conducted by regional representatives of GSA to identify a site on which the public building will be constructed, a representative from the regional office of HUD will participate in the site investigation for the purposes of providing a report on the availability of low- and moderate-income housing on a nondiscriminatory basis in the area of the investigation. Such report will constitute the principal basis for GSA's consideration of the availability of such housing in accordance with paragraphs 6 and 9(a).

(d) Major lease actions having a significant socioeconomic impact on a community: At the time GSA and the agencies who will occupy the space have tentatively delineated the general area in which the leased space must be located in order that the agencies may effectively perform their missions and programs, the regional representative of HUD will be consulted by the regional representative of GSA who is responsible for the leasing action to obtain advice from HUD concerning the availability of low- and moderate-income housing on a nondiscriminatory basis to the delineated area. Such advice will constitute the principal basis for GSA's consideration of the availability of such housing in accordance with paragraphs 6 and 9(a). Copies of lease-construction prospectuses approved by the Committees on Public Works of the Congress in conformity with the provisions of the Independent Offices and Department of Housing and Urban Development appropriation acts, will be provided to HUD.

(e) GSA and HUD will each issue internal operating procedures to implement this memorandum of understanding within a reasonable time after its execution. These procedures shall recognize the right of HUD, in the event of a disagreement between HUD and GSA representatives at the area or regional level, to bring such disagreement to

§ 101-19.4900

the attention of GSA officials at headquarters in sufficient time to assure full consideration of HUD's views, prior to the making of a determination by GSA.

(f) In the event a decision is made by GSA as to the location of a federally constructed building or leased space, and HUD has made findings, expressed in the advice given or a report made to GSA, that the availability to such location of low- and moderate-income housing on a nondiscriminatory basis is inadequate, the GSA shall provide the DHUD with a written explanation why the location was selected.

(g) Whenever the advice or report provided by HUD in accordance with paragraph 9(c)(1), 9(c)(2), or 9(d) with respect to an area or site indicates that the supply of low- and moderate-income housing on a nondiscriminatory basis is inadequate to meet the needs of the personnel of the agency involved, GSA and HUD will develop an affirmative action plan designed to insure that an adequate supply of such housing will be available before the building or space is to be occupied or within a period of 6 months thereafter. The plan should provide for commitments from the community involved to initiate and carry out all feasible efforts to obtain a sufficient quantity of low- and moderate-income housing available to the agency's personnel on a nondiscriminatory basis with adequate access to the location of the building or space. It should include commitments by the local officials having the authority to remove obstacles to the provision of such housing, when such obstacles exist, and to take effective steps to assure its provision. The plan should also set forth the steps proposed by the agency to develop and implement a counseling and referral service to seek out and assist its personnel to obtain such housing. As part of any plan during, as well as after its development, HUD agrees to give priority consideration to applications for assistance under its housing programs for the housing proposed to be provided in accordance with the plan.

10. This memorandum will be reviewed at the end of 1 year, and modified to incorporate any provision necessary to improve its effectiveness in light of actual experience.

Subpart 101-19.49—Illustration of Forms

§ 101-19.4900 Scope of subpart.

This subpart illustrates forms prescribed or available for use in connection with subject matter covered in other parts of part 101-19.

41 CFR Ch. 101 (7-1-01 Edition)

§ 101-19.4901 [Reserved]

§ 101-19.4902 GSA forms.

(a) The GSA forms are illustrated in this § 101-19.4902 to show their text, format, and arrangement and to provide a ready source of reference. The subsection numbers in this section correspond with the GSA form numbers.

(b) Agency field offices may obtain their initial supply of GSA Form 2974, Status Report for Federally Funded or Leased Buildings—Accommodation of Physically Handicapped, November 1981, from General Services Administration (WBRDD), Union and Franklin Streets Annex, Building 11, Alexandria, VA 22314. Agency field offices should submit all future requirements to their Washington headquarters office, which will then forward consolidated annual requirements to General Services Administration (ORA) Washington, DC 20405.

(Sec. 205(c), 63 Stat. 390; 40 U.S.C. 486(c))

[39 FR 23214, June 27, 1974, as amended at 48 FR 15629, Apr. 12, 1983]

§ 101-19.4902-2974 GSA Form 2974, Status Report for Federally Funded or Leased Buildings—Accommodation of Physically Handicapped.

NOTE: The form illustrated in this § 101-19.4902-2974 is filed with the original document and does not appear in this volume.

(Sec. 205(c), 63 Stat. 390; 40 U.S.C. 486(c))

[48 FR 15629, Apr. 12, 1983]

PART 101-20—MANAGEMENT OF BUILDINGS AND GROUNDS

Sec.

101-20.000 Scope of part.

101-20.001 Authority.

101-20.002 Basic policy.

101-20.002-1 Government-owned buildings.

101-20.002-2 Leased buildings.

101-20.003 Definitions.

Subpart 101-20.1—Building Operations, Maintenance, Protection, and Alterations

101-20.101 Building systems.

101-20.102 Cleaning and maintenance.

101-20.103 Physical protection and building security.

101-20.103-1 Standard protection.

101-20.103-2 Special protection.

101-20.103-3 Responsibilities of occupant agencies.

Federal Property Management Regulations

§ 101-20.001

- 101-20.103-4 Occupant Emergency Program.
- 101-20.103-5 Initiating action under Occupant Emergency Programs.
- 101-20.104 Parking facilities.
- 101-20.104-1 Allocation and assignment of parking for official needs.
- 101-20.104-2 Allocation and assignment of employee parking spaces.
- 101-20.104-3 Utilization of parking.
- 101-20.104-4 Guidelines for agency implementation.
- 101-20.105 Accident and fire prevention.
- 101-20.105-1 Responsibilities of occupant agencies.
- 101-20.105-2 Correction of hazardous conditions.
- 101-20.105-3 Smoking.
- 101-20.106 Reimbursable services.
- 101-20.106-1 Placing of orders for reimbursable alterations by occupant agencies.
- 101-20.106-2 Limitations on provision of reimbursable services by GSA.
- 101-20.107 Energy conservation.
- 101-20.108 Staggered hours of duty.
- 101-20.109 Concessions.
- 101-20.402 Permits.
- 101-20.403 Disapproval of applications or cancellation of permits.
- 101-20.404 Appeals.
- 101-20.405 Schedules of use.
- 101-20.406 Hours of use.
- 101-20.407 Services and costs.
- 101-20.408 Conduct.
- 101-20.409 Non-affiliation with the Government.

Subpart 101-20.5—Sidewalk Installation, Repair, and Replacement

- 101-20.500 Scope of subpart.
- 101-20.501 Responsibilities.
- 101-20.502 Standards.

AUTHORITY: 40 U.S.C. 486(c).

SOURCE: 52 FR 11263, Apr. 8, 1987, unless otherwise noted.

§ 101-20.000 Scope of part.

(a) The regulations in this part prescribe policies and procedures for the management, operation, protection, and maintenance of Government-owned and leased buildings and grounds under the assignment responsibility of GSA.

(b) For more information on the management of buildings and grounds, see 41 CFR parts 102-71 through 102-82. To the extent that any policy statements in this part are inconsistent with the policy statements in 41 CFR parts 102-71 through 102-82 are controlling.

[52 FR 11263, Apr. 8, 1987, as amended at 66 FR 5359, Jan. 18, 2001]

§ 101-20.001 Authority.

This part 101-20 implements the Act of July 1, 1898 (40 U.S.C. 285); the Act of April 28, 1902 (40 U.S.C. 19); the Act of March 1, 1919 (40 U.S.C. 1); the Act of June 23, 1923 (40 U.S.C. 281); the Act of May 27, 1924 (D.C. Code, 1961 ed., 4-208); the Act of June 20, 1936 (20 U.S.C. 107 *et seq.*); the Act of December 10, 1941 (40 U.S.C. 291); the Act of May 14, 1948 (40 U.S.C. 130); the Act of June 1, 1948 (40 U.S.C. 318 *et seq.*); the Federal Property and Administrative Services Act of 1949 (63 Stat. 377 as amended); the Reorganization Plan No. 18 of 1950 (40 U.S.C. 490 note; 3 CFR); the Public Buildings Act of 1950 (73 Stat. 479) as amended; and the Public Buildings Amendments of 1972 (40 U.S.C. 602a).

Subpart 101-20.2—Vending Facility Program for Blind Persons

- 101-20.200 Scope of subpart.
- 101-20.201 Policy.
- 101-20.202 Establishing vending facilities.
- 101-20.203 Application for permit.
- 101-20.204 Terms of permit.
- 101-20.205 Enforcement procedures.
- 101-20.206 Reports.

Subpart 101-20.3—Conduct on Federal Property

- 101-20.300 Applicability.
- 101-20.301 Inspection.
- 101-20.302 Admission to property.
- 101-20.303 Preservation of property.
- 101-20.304 Conformity with signs and directions.
- 101-20.305 Disturbances.
- 101-20.306 Gambling.
- 101-20.307 Alcoholic beverages and narcotics.
- 101-20.308 Soliciting, vending, and debt collection.
- 101-20.309 Posting and distributing materials.
- 101-20.310 Photographs for news, advertising, or commercial purposes.
- 101-20.311 Dogs and other animals.
- 101-20.312 Vehicular and pedestrian traffic.
- 101-20.313 Explosives.
- 101-20.314 Nondiscrimination.
- 101-20.315 Penalties and other laws.

Subpart 101-20.4—Occasional Use of Public Buildings

- 101-20.400 Scope of subpart.
- 101-20.401 Applications for permits.

§ 101-20.002

41 CFR Ch. 101 (7-1-01 Edition)

§ 101-20.002 Basic policy.

It is the responsibility of GSA to provide or otherwise arrange for all services required to house occupant agencies. GSA shall provide fully service space equivalent to that furnished in commercial practice.

§ 101-20.002-1 Government-owned buildings.

(a) GSA will provide space alterations, repairs, and improvements sufficient to meet the mission requirements of occupant agencies, including mechanical and electrical systems which meet nationally recognized standards, within the limitations of available funding. When alterations are required, alterations which are essential for performance of agency missions or which improve the utilization rate shall be given priority over other alterations. Alterations solely for decorative or non-essential purposes shall be avoided.

(b) GSA will ensure that space assigned to agencies is safe and that employees and visitors are not exposed to unnecessary risks.

(c) Buildings will be cleaned and maintained at a service level equivalent to that normally furnished commercially in similar space.

(d) GSA will make every effort to provide or arrange for a reasonable amount of protective services to ensure the physical security of occupants and visitors, to safeguard the Government's property interests, and to maintain order.

(e) GSA shall ensure that physically handicapped persons will have ready access to space assigned to occupant agencies. GSA shall provide building standards and shall prescribe and enforce appropriate guidelines in accordance with applicable statutes, regulations and executive orders.

(f) GSA is responsible for ensuring the availability of parking spaces for officials needs. Parking priorities are as established in §101-20.104.

(g) Services in addition to those normally provided in the commercial sector shall be arranged by GSA on a reimbursable basis, as provided in §101-20.106.

(h) GSA may, by agreement with occupant agencies, delegate authority to

perform specified functions with respect to the operation, maintenance or repair of GSA-assigned space.

(i) GSA will maintain a comprehensive energy management program to reduce energy consumption and costs in Federal buildings. GSA will apply energy-efficient and economical operating and maintenance procedures, will make cost-effective repairs and alterations, will incorporate design features which will minimize the life cycle cost of buildings, and will ensure continuity of services through contingency planning.

(j) Occupant agencies shall assist in the management of buildings by exercising economy in the use of utilities, by observing professional standards of neatness and cleanliness, and by taking all reasonable precautions to avoid the risk of accidents and fires. Occupant agencies shall also document and report to GSA any hazardous or unhealthy conditions in GSA-assigned space.

(k) Consultations with occupant agencies and their safety representatives will be held whenever substantial alterations or repairs are proposed to be undertaken, or when GSA proposes to make significant changes to the standard level of services. GSA will consider the comments of occupant agencies before final decisions are made. GSA will make every reasonable effort to involve representatives of occupant agencies in the planning for such proposed alterations, repairs, and changes in services.

(l) It is the general policy of GSA to provide space and systems which substantially conform to nationally recognized standards, when applicable. GSA may, however, adopt other standards for space and systems in Federally-controlled facilities in order to conform to diverse statutory requirements, to implement cost-reduction efforts, or to better effect overall Government objectives.

§ 101-20.002-2 Leased buildings.

(a) Standards for space and services in leased buildings will be equivalent to standards for Government-owned

space. However, the scope of the functions performed by GSA will be modified to reflect the lessor's responsibilities for operations, maintenance and protection under the terms of the lease.

(b) Alterations, improvements and repairs in leased buildings shall be performed by GSA to the extent of the Government's responsibility under the lease. Such alterations shall not, however, exceed the limitations of the Economy Act (40 U.S.C. 278(a)) except as otherwise provided by law.

(c) Occupant agencies are not authorized to negotiate with lessors or to place orders for alterations or building services, except where such authority has been specifically delegated by GSA, and except as provided in §101-20.106-2 regarding reimbursable services.

§ 101-20.003 Definitions.

(a) *Alteration* means remodeling, improving, extending, or making other changes to a facility, exclusive of maintenance repairs which are preventive in nature. The term includes planning, engineering, architectural work, and other similar actions.

(b) *Blanket work authorization* means an open-end agreement with an agency with an agreed upon maximum dollar ceiling where there is an on-going account for processing small requests for reimbursable services. The need for the service is clearly recognized, but exactly when the service must be rendered during the fiscal year is unclear.

(c) *Carpool* means a group of two or more people regularly using a motor vehicle for transportation to and from work on a continuing basis, regardless of their relationship to each other. The number of persons in a carpool will normally be the basis for priority of assignments.

(d) *Commercial activities*, within the meaning of subpart 101-20.4, are activities undertaken for the primary purpose of producing a profit for the benefit of an individual or organization organized for profit. (Activities where commercial aspects are incidental to the primary purpose of expression of ideas or advocacy of causes are not "commercial activities" for purposes of these regulations.)

(e) *Crime prevention assessments* are formal, on-site reviews which consist of a detailed survey, review, and analysis of an occupant agency's vulnerability to criminal activity. In addition to the normal process of a physical security survey, it involves an intensive review of an occupant's and/or building's operation and administrative procedures. It is designed to identify specific weaknesses and to recommend cost-effective, positive steps to Federal managers in dealing with criminal threats and occurrences.

(f) *Cultural activities* include, but are not limited to, films, dramatics, dances, and musical presentations, and fine art exhibits, whether or not these activities are intended to make a profit.

(g) The *Designated Official* is the highest ranking official of the primary occupant agency of a Federal facility; or, alternatively, a designee selected by mutual agreement of occupant agency officials.

(h) *Educational activities* mean activities such as (but not limited to) the operation of schools, libraries, day care centers, laboratories, and lecture or demonstration facilities.

(i) The term *emergency* includes bombings and bomb threats, civil disturbances, fires, explosions, electrical failures, loss of water pressure, chemical and gas leaks, medical emergencies, hurricanes, tornadoes, floods, and earthquakes. The term does not apply to civil defense matters such as potential or actual enemy attacks. Note: Civil defense emergencies are addressed by the Federal Emergency Management Agency.

(j) *Executive* means a Government employee with management responsibilities which, in the judgment of the employing agency head or his/her designee, require preferential assignment of parking privileges.

(k) *Flame-resistant* means meeting performance standards as described by the National Fire Protection Association (NFPA Standard No. 701). Fabrics labeled with the Underwriters Laboratories Inc. classification marking for flammability are deemed to be flame-resistant for purposes of this regulation.

(l) *Foot-candle* is the illumination on a surface one square foot in area on

which there is a uniformly distributed flux of one lumen, or the illuminance produced on a surface all points of which are at a distance of one foot from a directionally uniform point source of one candela.

(m) *GSA Regional Officer*, within the meaning of subpart 101-20.4, means the regional director of the Buildings Management Division of GSA designated to supervise the implementation of the Public Buildings Cooperative Use Act's occasional use provisions.

(n) *Handicapped employee* means an employee who has a severe, permanent impairment which for all practical purposes precludes the use of public transportation, or an employee who is unable to operate a car as a result of permanent impairment who is driven to work by another. Priority may require certification by an agency medical unit, including the Veterans Administration or the Public Health Service.

(o) *Indefinite quantity contract* (commonly referred to as "term contract") provides for the furnishing of an indefinite quantity, within stated limits, of specific property or services during a specified contract period, with deliveries to be scheduled by the timely placement of orders upon the contractor by activities designated either specifically or by class.

(p) *Life cycle cost* is the total cost of owning, operating, and maintaining a building over its useful life, including its fuel and energy costs, determined on the basis of a systematic evaluation and comparison of alternative building systems; except that in the case of leased buildings, the life cycle cost shall be calculated over the effective remaining term of the lease.

(q) *Limited combustible* means rigid materials or assemblies which have fire hazard ratings not exceeding 25 for flame spread and 150 for smoke development when tested in accordance with the American Society for Testing and Materials, Test E 84, Surface Burning Characteristics of Building Materials.

(r) *Maintenance* means preservation by inspection, adjustment, lubrication, cleaning, and the making of minor repairs. *Ordinary maintenance* means routine recurring work which is incidental to everyday operations; *preventive*

maintenance means work programmed at scheduled intervals.

(s) The term *nationally recognized standards* encompasses any standard or modification thereof which:

(1) Has been adopted and promulgated by a nationally recognized standards-producing organization under procedures whereby those interested and affected by it have reached substantial agreement on its adoption, or

(2) Was formulated through consultation by appropriate Federal agencies in a manner which afforded an opportunity for diverse views to be considered.

(t) *Normally furnished commercially* means in conformance with the level of services provided by a commercial building operator for space of comparable quality, housing tenants with comparable requirements. Service levels are based on the effort required to service space for a five-day week, one eight-hour shift schedule.

(u) *Occupant agency* means an organization which is assigned space in a facility under GSA's custody and control through the formal procedures outlined in part 101-17 of the Federal Property Management Regulations.

(v) *Occupancy Emergency Organization* means the emergency response organization comprised of employees of Federal agencies designated to perform the requirements established by the Occupant Emergency Plan.

(w) *Occupant Emergency Plan* means procedures developed to protect life and property in a specific Federally-occupied space under stipulated emergency conditions.

(x) *Occupant Emergency Program* means a short-term emergency response program. It establishes procedures for safeguarding lives and property during emergencies in particular facilities.

(y) *Postal vehicle* means a Government-owned vehicle used for the transportation of mail, or a privately owned vehicle used under contract for the transportation of mail.

(z) *Public area* means any area of a building under the control and custody of GSA which is ordinarily open to members of the public, including lobbies, courtyards, auditoriums, meeting

rooms, and other such areas not assigned to a lessee or occupant agency.

(aa) *Recognized labor organization* means a labor organization recognized under title VII of the Civil Service Reform Act of 1978 (Public Law 95-454) governing labor-management relations.

(bb) *Recreational activities* include, but are not limited to, the operations of gymnasiums and related facilities.

(cc) *Ridesharing* means the sharing of the commute to and from work by two or more people, on a continuing basis, regardless of their relationship to each other, in any mode of transportation including, but not limited to, carpools, vanpools, buspools and mass transit.

(dd) *Special space alterations* are those alterations required by occupant agencies that are beyond those standard alterations provided by GSA under the SLUC system and are reimbursable from the requesting agency.

(ee) *State* means the fifty States, political subdivisions thereof, the District of Columbia, the Commonwealths of Puerto Rico and Guam, and the territories and possessions of the United States.

(ff) *Unit price agreement* provides for the furnishing of an indefinite quantity, within stated limits, of specific property or services at a specified price, during a specified contract period, with deliveries to be scheduled by the timely placement of orders upon the lessor by activities designated either specifically or by class.

(gg) *Unusual hours* means work hours that are frequently required to be varied and do not coincide with any regular work schedule. This category includes individuals who regularly or frequently work significantly more than 8 hours per day. Unusual hours does not include shift workers, those on alternate work schedules, and those granted exceptions to the normal work schedule (e.g., flex-time).

(hh) *Vanpool* means a group of at least 8 persons using a passenger van or a commuter bus designed to carry 10 or more passengers. Such a vehicle must be used for transportation to and from work in a single daily round trip. The number of persons in a vanpool will normally be the basis for priority of assignments.

(ii) *Zonal allocations* means the allocation of parking spaces on the basis of zones established by GSA in conjunction with occupant agencies. In metropolitan areas where this method is used, all agencies located in a designated zone will compete for available parking in accordance with instructions issued by GSA. In establishing this procedure, GSA will consult with all affected agencies.

Subpart 101-20.1—Building Operations, Maintenance, Protection, and Alterations

§ 101-20.101 Building systems.

(a) Structural features and mechanical and electrical systems in GSA-assigned space shall be adequate for the needs of occupant agencies. Such systems will comply with applicable GSA fire safety criteria and with standards prescribed under the Occupational Safety & Health Act (OSHA). GSA will take all measures necessary to comply with energy conservation objectives as promulgated by relevant statutes, regulations, and executive orders.

(b) No modification shall be made to buildings, or equipment which will exceed the building design loads or exceed the capacities of electrical, mechanical, and protection systems. No modifications which adversely alter the performance of building systems, or which create safety and health hazards, as determined by GSA safety and health representatives, shall be made.

(c) Occupant agencies shall obtain GSA approval for any modifications proposed to be made with their own forces. This approval requirement applies to the moving or installation of unusually heavy equipment, to electrical appliances such as heaters, refrigerators, and cooking equipment, and to employee-owned equipment.

(d) Occupant agencies shall conform to GSA accident and fire prevention policy, shall observe all OSHA requirements, and shall comply with applicable local safety regulations.

§ 101-20.102 Cleaning and maintenance.

GSA shall provide:

§ 101-20.103

(a) Cleaning for all assigned space at a level equivalent to the cleaning furnished commercially for similar types of space.

(b) Maintenance of building systems for heating and cooling, and maintenance of plumbing, electrical, and elevator systems.

(c) Maintenance and repairs of exterior, grounds, sidewalks, driveways, and parking areas.

(d) Maintenance of building equipment such as directory boards, clock systems, window shades, door locks, and door title cards.

(e) [Reserved]

(f) Maintenance of all safety and fire protection devices, equipment, and systems in a state of readiness in conformance with applicable laws, regulations, and standards.

(g) Maintenance of all food service activities in accordance with applicable U.S. Public Health Service standards and local regulations.

(h) Arrangements for raising and lowering the United States flags at appropriate times.

[52 FR 11263, Apr. 8, 1987, as amended at 66 FR 23169, May 8, 2001]

§ 101-20.103 Physical protection and building security.

§ 101-20.103-1 Standard protection.

For properties under its custody and control, GSA will provide standard protection services by:

(a) Responding to criminal occurrences, incidents, and lifethreatening events through the use of Federal Protective Officers and local law enforcement officers where a response agreement is in effect.

(b) Installing and maintaining perimeter security devices and systems if they are monitored to provide timely response by authorized personnel;

(c) Implementing crime prevention activities, including tenant awareness programs;

(d) Investigating crimes and violations of Federal statutes, recording and evaluating reports of criminal incidents, and referring findings and evidence to appropriate enforcement agencies;

41 CFR Ch. 101 (7-1-01 Edition)

(e) Entering into cooperative agreements with local law enforcement agencies;

(f) Performing physical security surveys and providing security advisory services; or

(g) Coordinating a comprehensive Occupant Emergency Program.

(h) Periodically evaluating the effectiveness of protection services by in-depth inspections of procedures and records.

§ 101-20.103-2 Special protection.

The degree of protection beyond standard levels required by the nature of an agency's activities or by unusual public reaction to an agency's programs will be determined jointly by GSA and the occupant agency. Special protection will be provided on a reimbursable basis. The level of special protection will be determined on a facility-by-facility basis, after the conducting of appropriate security surveys and crime prevention assessments. In such determinations, GSA and occupant agencies will consider:

(a) The characteristics of the facility, including size, configuration, exterior lighting, and presence of physical barriers;

(b) The location of the facility and the history of criminal or disruptive incidents in the surrounding neighborhoods; and

(c) The reimbursable funding and resources available to GSA for provision of protective service.

(d) Tenant agency's mission.

§ 101-20.103-3 Responsibilities of occupant agencies.

Occupants of facilities under the custody and control of GSA shall:

(a) Cooperate to the fullest extent with all pertinent facility procedures and regulations;

(b) Promptly report all crimes and suspicious circumstances occurring on GSA-controlled property to the regional Law Enforcement Branch and other designated law enforcement agencies and then through internal agency channels;

(c) Provide training to employees regarding protection and responses to emergency situations; and

Federal Property Management Regulations

§ 101-20.104

(d) Make recommendations for improving the effectiveness of protection in Federal facilities.

§ 101-20.103-4 Occupant Emergency Program.

(a) The Designated Official (as defined in § 101-20.003(g)) is responsible for developing, implementing, and maintaining an Occupant Emergency Plan (as defined in § 101-20.003(w)). The Designated Official's responsibilities include establishing, staffing, and training an Occupant Emergency Organization with agency employees. GSA shall assist in the establishment and maintenance of such plans and organizations.

(b) All occupant agencies of a facility shall fully cooperate with the Designated Official in the implementation of the emergency plans and the staffing of the emergency organization.

(c) GSA shall provide emergency program policy guidance, shall review plans and organizations annually, shall assist in training of personnel, and shall otherwise ensure proper administration of Occupant Emergency Programs (as defined in § 101-20.003(x)). In leased space, GSA will solicit the assistance of the lessor in the establishment and implementation of plans.

(d) In accordance with established criteria, GSA shall assist the Occupant Emergency Organization (as defined in § 101-20.003(v)) by providing technical personnel qualified in the operation of utility systems and protective equipment.

[52 FR 11263, Apr. 8, 1987; 52 FR 24158, July 29, 1987]

§ 101-20.103-5 Initiating action under Occupant Emergency Programs.

(a) The decision to activate the Occupant Emergency Organization shall be made by the Designated Official, or by the designated alternate official. Decisions to activate shall be based upon the best available information, including an understanding of local tensions, the sensitivity of target agency(ies), and previous experience with similar situations. Advice shall be solicited, when possible, from the GSA buildings manager, from the appropriate Federal Protective Service official, and from Federal, State, and local law enforcement agencies.

(b) When there is immediate danger to persons or property, such as fire, explosion, or the discovery of an explosive device (not including a bomb threat), occupants shall be evacuated or relocated in accordance with the plan without consultation. This shall be accomplished by sounding the fire alarm system or by other appropriate means.

(c) When there is advance notice of an emergency, the Designated Official shall initiate appropriate action according to the plan.

(d) After normal duty hours, the senior Federal official present shall represent the Designated Official or his/her alternates and shall initiate action to cope with emergencies in accordance with the plans.

§ 101-20.104 Parking facilities.

(a) Parking facilities shall be compatible with the character of neighborhoods and consistent with local planning requirements. They shall not adversely affect the use or appearance of property, and shall not create traffic hazards.

(b) As necessary or upon agency request, GSA may provide for the regulation and policing of parking facilities. GSA will consult with primary occupant agencies prior to implementing procedural changes. Such regulation and policing may include:

(1) The issuance of traffic rules and regulations;

(2) The installation of signs and markings for traffic control. (Signs and markings shall be in conformance with the Manual on Uniform Traffic Control Devices published by the Department of Transportation);

(3) The issuance of citations for parking violations; and

(4) The immobilization or removal of illegally parked vehicles.

(c) When the use of parking space is controlled as in paragraph (b) of this section, all privately owned vehicles other than those authorized to use designated visitor or service areas must display a parking permit. This requirement may be waived in parking facilities where the number of available space regularly exceeds the demand for such spaces.

§ 101-20.104-1

41 CFR Ch. 101 (7-1-01 Edition)

(d) GSA may delegate the responsibility for management, regulation, and policing of parking facilities by agreement with occupant agencies or by contractual arrangements with lessors or parking management contractors. Where possible, existing contracts shall be amended or modified before renewal to conform with the policies of this regulation.

(e) Privately owned vehicles converted for propane carburetion will not be permitted in underground parking facilities unless the owner provides to the occupant agency and the GSA buildings manager the installer's certification that the installation methods and equipment meet the standards in National Fire Protection Association (NFPA) Standard No. 58.

§ 101-20.104-1 Allocation and assignment of parking for official needs.

GSA is responsible for ensuring the availability of parking spaces for official needs. GSA may, by mutual agreement, delegate allocation and assignment responsibilities to occupant agencies or boards, commissions, and similar groups. GSA and other agencies with assignment responsibilities shall determine the appropriate number of spaces at each facility for official purposes; such determinations will be based upon submissions of information from occupant agencies regarding their needs. Parking spaces in controlled facilities shall first be reserved for official needs, in the following order of priority:

(a) At buildings containing U.S. Postal Service mailing operations, official postal vehicles.

(b) Government-owned vehicles used for criminal apprehension, firefighting, and other emergency functions.

(c) Privately owned vehicles of Federal judges appointed under Article III of the Constitution and of Members of Congress. (This priority does not extend to members of their staffs.)

(d) Other Government-owned and leased vehicles, including motor pool vehicles and vehicles assigned for general use.

(e) Service vehicles and vehicles of patrons and visitors. (Accommodations for handicapped visitors shall be pro-

vided when necessitated by agency program requirements. Agencies are encouraged to provide accommodations for handicapped visitors.)

§ 101-20.104-2 Allocation and assignment of employee parking spaces.

(a) Parking spaces not required for official needs may be used for employee parking.

(b) GSA (or other agencies having assignment responsibilities) will determine the total number of spaces available for employee parking. Normally, a separate determination will be made for each parking facility. In major metropolitan areas, however, GSA and occupant agencies may ascertain that zonal allocations would achieve more efficient use of space or equality in the availability of parking.

(c) Space available for employee parking will be allocated for occupant agency use on an equitable basis. Allocations may be made in proportion to each agency's share of building space, office space, or total employee population, as appropriate. In certain cases, GSA may allow a third party, such as a board composed of representatives of agencies sharing space, to determine proper reallocations among the agencies.

(d) Agencies shall in turn assign spaces to their employees, using the following order of priority:

(1) Severely handicapped employees. Justifications based on medical opinion may be required.

(2) Executive personnel and persons who work unusual hours.

(3) Vanpool/carpool vehicles.

(4) Privately owned vehicles of occupant agency employees which are regularly used for Government business at least 12 days per month and which qualify for reimbursement of mileage and travel expenses under Government travel regulations.

(5) Other privately owned vehicles of employees, on a space-available basis. (In locations where parking allocations are made on a zonal basis, GSA and affected agencies may cooperate to issue additional rules, as appropriate.)

Federal Property Management Regulations

§ 101-20.105-1

§ 101-20.104-3 Utilization of parking.

(a) Agencies shall develop, implement, and maintain ridesharing programs. (Guidelines for the administration of ridesharing programs are contained in FPMR Amendment A-36.)

(b) GSA will take all feasible measures to improve the utilization of parking facilities. Such measures may include the conducting of surveys and studies, the periodic review of parking space allocations, the dissemination of parking information to agencies, the implementation of parking incentives which promote ridesharing, the use of stack parking practices where appropriate, and the employment of parking management contractors and concessionaires.

§ 101-20.104-4 Guidelines for agency implementation.

(a) In most instances, the assignment of individual reserved spaces should be minimized; this allows the number of permits to be overallocated and results in increased efficiency.

(b) In order to promote fuel conservation, reduce traffic congestion, reduce the demand for parking spaces, and reduce air pollution, agencies are encouraged to make available as many parking spaces as possible for the use of vanpools/carpools.

(c) Agency procedures for the assignment of parking spaces should be maintained in writing. Provisions for reviewing assignments, enforcing compliance with regulations, and enforcing penalties for misrepresentation on applications are also recommended.

(d) Occupant agencies should make every effort to schedule arrival and departure times for employees to facilitate ridesharing.

(e) Subject to the availability of satisfactory and secure space and facilities, agencies should reserve areas for the parking of bicycles and other two-wheeled vehicles. Bicycles should not be transported on elevators or via stairways, nor should they be parked in offices.

(f) Implementation of the provisions of this regulation may require consultation, as appropriate, with recognized labor organizations.

§ 101-20.105 Accident and fire prevention.

Standards for GSA-assigned space will conform to those presented by the Occupational Safety and Health Act (OSHA) of 1970 (Public Law 91-596); Executive Order 12196; 29 CFR part 1960, and applicable GSA fire and safety criteria. Occupants and visitors will not be exposed to unnecessary risks. Safeguards which minimize personal harm, property damage, and impairment of Governmental operations, and which allow emergency forces to accomplish their missions effectively, will be provided. To the maximum extent feasible, GSA will provide space which meets or exceeds these objectives.

§ 101-20.105-1 Responsibilities of occupant agencies.

(a) Each occupant agency shall maintain a neat and orderly facility to minimize the risk of accidental injuries and fires. All exits, accesses to exits, and accesses to emergency equipment shall be kept clear at all times.

(b) Hazardous explosive or combustible materials shall not be brought into buildings unless authorized by appropriate agency officials and by GSA and unless protective arrangements determined necessary by GSA have been provided. All draperies, curtains, or other hanging materials shall be of non-combustible or flame-resistant fabric. Freestanding partitions and space dividers shall be limited combustible, and fabric coverings shall also be flame resistant.

(c) Occupant agencies shall cooperate with GSA to develop and maintain fire prevention programs. Such programs shall ensure the maximum safety of the occupants by:

(1) Training employees to use protective equipment and educating employees to take appropriate fire safety precautions in their work, including participating in at least one fire drill each year, and

(2) Ensuring that facilities are kept in the safest condition practicable, and conducting periodic inspections in accordance with Executive Order 12196 and 29 CFR part 1960.

(d) Accidents resulting from building system or maintenance deficiencies

§ 101-20.105-2

which involve personal injury or property damage in GSA-assigned space will be reported immediately to the GSA buildings manager.

(e) Each occupant agency shall appoint a safety, health and fire protection liaison to represent the occupant agency with GSA.

§ 101-20.105-2 Correction of hazardous conditions.

(a) GSA is responsible for correcting hazards associated with the condition of the space it assigns, including hazards related to building features, fixtures, and systems. GSA is also responsible for correcting hazards in common, joint, and public use spaces. Occupant agencies are responsible for correcting hazards associated with their use of assigned space, including those related to the operation of their program equipment.

(b) Hazardous conditions within the occupant agency's responsibility to correct shall be corrected within 30 workdays when possible. Imminently dangerous conditions shall be corrected immediately upon their discovery. If more than 30 workdays are required for correction, an abatement plan shall be prepared in accordance with 29 CFR part 1960. Corrective alteration measures may be undertaken in accordance with §101-20.106, Reimbursable services.

(c) Conditions within GSA's responsibility to correct shall be identified, documented and presented to the GSA buildings manager. Imminently dangerous conditions shall be corrected immediately upon their discovery. When an imminently dangerous condition as defined by 29 CFR 1960.28 exists, this report shall be made by telephone. Upon receipt of a properly documented report of hazardous conditions, GSA will promptly investigate, determine a plan to resolve the problems, and inform the occupant agency. Such reports shall state the hazardous condition and cite references to specific OSHA standards violated. In cases involving health problems, agencies shall provide to GSA an industrial hygienist's report of an investigation of the alleged problem, which must include a description of the problem, results of testing, and recommendations for correction. When resolution will take

41 CFR Ch. 101 (7-1-01 Edition)

more than 30 workdays, GSA shall prepare an abatement plan in accordance with 29 CFR part 1960, shall furnish this plan to the occupant agency for review and subsequent follow-up, and shall give priority to prompt abatement of the conditions.

§ 101-20.105-3 Smoking.

(a) Pursuant to Executive Order 13058, "Protecting Federal Employees and the Public From Exposure to Tobacco Smoke in the Federal Workplace" (3 CFR, 1997 Comp., p. 216), it is the policy of the executive branch to establish a smoke-free environment for Federal employees and members of the public visiting or using Federal facilities. The smoking of tobacco products is prohibited in all interior space owned, rented, or leased by the executive branch of the Federal Government, and in any outdoor areas under executive branch control in front of air intake ducts.

(b) *Exceptions.* (1) The policy does not apply in designated smoking areas that are enclosed and exhausted directly to the outside and away from air intake ducts, and are maintained under negative pressure (with respect to surrounding spaces) sufficient to contain tobacco smoke within the designated area. Agency officials shall not require workers to enter such areas during business hours while smoking is ongoing.

(2) The policy does not extend to any residential accommodation for persons voluntarily or involuntarily residing, on a temporary or long term basis, in a building owned, leased, or rented by the Federal Government.

(3) The policy does not extend to those portions of federally owned buildings leased, rented, or otherwise provided in their entirety to nonfederal parties.

(4) The policy does not extend to places of employment in the private sector or in other nonfederal governmental units that serve as the permanent or intermittent duty station of one or more Federal employees.

(5) Agency heads may establish limited and narrow exceptions that are necessary to accomplish agency missions. Such exceptions must be in writing, approved by the agency head, and

Federal Property Management Regulations

§ 101-20.106-1

to the fullest extent possible provide protection of nonsmokers from exposure to environmental tobacco smoke. Authority to establish such exceptions may not be delegated.

(c) Agency heads have responsibility to determine which areas are to be smoking and which areas are to be non-smoking areas. In exercising this responsibility, agency heads will give appropriate consideration to the views of the employees affected and/or their representatives and are to take into consideration the health issues involved. Nothing in this section precludes an agency from establishing more stringent guidelines. Agencies in multi-tenant buildings are encouraged to work together to identify designated smoking areas.

(d) Agency heads shall evaluate the need to restrict smoking at doorways and in courtyards under executive branch control in order to protect workers and visitors from environmental tobacco smoke, and may restrict smoking in these areas in light of this evaluation.

(e) Agency heads shall be responsible for monitoring and controlling areas designated for smoking and for ensuring that these areas are identified by proper signs. Suitable uniform signs reading "Designated Smoking Area" shall be furnished and installed by the agency.

(f) Suitable, uniform signs reading "No Smoking Except in Designated Areas" shall be placed on or near entrance doors of buildings subject to this section. These signs shall be furnished and installed by the GSA Building Manager in buildings operated by GSA. It shall not be necessary to display a sign in every room of each building.

(g) This smoking policy applies to the judicial branch when it occupies space in buildings controlled by the executive branch. Furthermore, the Federal chief judge in a local jurisdiction may be deemed to be comparable to an agency head and may establish exceptions for Federal jurors and others as indicated in paragraph (b)(5) of this section.

(h) Prior to implementation of this section, where there is an exclusive representative for the employees, the

agencies shall meet their obligation under the Federal Service Labor-Management Relations Act (5 U.S.C. 7101 *et seq.*) In all other cases, agencies should consult directly with employees.

[63 FR 35846, July 1, 1998]

§ 101-20.106 Reimbursable services.

Services in addition to those standard level services prescribed in §§101-20.101 through 20.105 may be provided or arranged for by GSA on a reimbursable basis. Such services include:

(a) Specialized security services beyond standard levels, such as guarding, ingress-egress control, inspection of packages, directed security patrols, and other similar activities;

(b) Design, installation, maintenance, and operation of electronic systems such as intrusion-detection devices, duress-holdup alarms, and remote monitoring systems;

(c) Utilities for specialized equipment, or for times when space conditioning beyond standard levels is required;

(d) Construction and/or alterations necessary for installation of agency program equipment;

(e) Space adjustments requested by an occupant agency for its convenience in moving activities within its already assigned space;

(f) Janitorial and other services over and above standard levels;

(g) Space alterations beyond the standard level provided by GSA;

(h) Construction, installation, operation, maintenance, and repair of agency program equipment, and space adjustments required as a result of such installations;

(i) Services of motion picture operators and other technicians required in the use of auditoriums, conference rooms, and special agency equipment; and

(j) Office design, space planning, and office automation installation support and services.

§ 101-20.106-1 Placing of orders for reimbursable alterations by occupant agencies.

(a) Where GSA has indefinite quantity contracts and/or unit price agreements available for accomplishment of space alterations in Government owned

and leased buildings, agencies should order against these contracts and agreements, except when it is not in the Government's best interest. Agencies wishing to use this authority shall submit names of their proposed ordering officials to the GSA buildings manager, who will submit them to the GSA contracting officer. The contracting officer shall designate in writing the ordering officials and will authorize the contractor to accept orders from the designated ordering officials. The GSA contracting officer shall advise the agencies' ordering officials in writing of their responsibilities, authorities, and limitations under these contracts and agreements.

(b) No individual order, or combinations of orders for a single alteration project, shall exceed the simplified acquisition threshold, as defined in 41 U.S.C. 252a, and agencies shall not split orders so as to circumvent this limitation.

(c) For all orders placed against GSA contracts or agreements, agency ordering officials shall obtain prior written project review by GSA and provide a copy of the ordering document and final payment document to the GSA buildings manager. Agencies are responsible for inspecting and certifying satisfactory completion of the work, and for ensuring contractor compliance with contract provisions. The final payment document shall be supported by GSA Form 1142, Release of Claims; GSA Form 2419, Certification of Payments to Subcontractors and Supplies; and certification that the work has been inspected and accepted.

(d) Agencies may not negotiate with contractors for items not specifically priced under indefinite quantity contracts and/or price agreements.

(e) Where no GSA contracts or agreements are in effect, an agency may contract directly for services up to the simplified acquisition threshold per project after written review by GSA. Agencies contracting directly must provide GSA with complete documentation of the scope of work and contract specifications at the time of submission. Each project shall include appropriate reviews by the regional safety staff. If contracting for security systems, agencies must submit the de-

sign work for regional Federal Protective Service Division review. Agencies shall be responsible for inspecting and certifying satisfactory completion of the ordered work. All work must conform to GSA fire and safety standards. GSA at anytime has the authority to make inspections and require correction if the project is found not in compliance with GSA reviews or fire and safety standards. As-built drawings must be submitted to GSA's buildings manager within 30 days of completion of the work.

[52 FR 11263, Apr. 8, 1987, as amended at 62 FR 1057, Jan. 8, 1997]

§ 101-20.106-2 Limitations on provision of reimbursable services by GSA.

In order to reduce processing costs of documents and to improve efficiency of service delivery, requests for reimbursable work to be performed or arranged by GSA may be subject to the following requirements:

(a) Individual work authorizations (e.g., GSA Form 2957's) for which total expenses as estimated by GSA are less than \$500 need not be processed by GSA, but may be returned to the requesting agency. Unless the work is related to security or required to correct an unhealthful or unsafe condition, occupant agencies may be required to hold all such requests until the reimbursable work in question can be aggregated into a single request for at least \$500.

(b) The restrictions of paragraph (a) of this section are not mandatory, but may be applied by GSA when their application is in the best interests of the Government from the standpoint of cost effectiveness.

(c) The restrictions of paragraph (a) of this section do not apply to orders placed against existing blanket or open-end authorizations which exceed \$500 and which show obligated and unused fund balances sufficient to perform the work.

(d) Agencies requesting reimbursable services are responsible for verifying and approving GSA estimates within 30 calendar days following submission of

such estimates to the requester. Reimbursable work requests for which estimates have not been approved within 30 days will be canceled.

§ 101-20.107 Energy conservation.

Agencies shall comply with the energy conservation guidelines set forth in 10 CFR part 436 (Federal Energy Management and Planning Programs) and shall observe the energy conservation policies cited herein.

(a) Agencies shall ensure that lights and equipment are turned off when not needed, that ventilation is not blocked or impeded, and that windows and other building accesses are closed during the heating and cooling seasons.

(b) Except where special circumstances exist, illumination levels shall be maintained as near as is practical to the following standards:

(1) 50 foot-candles at work station surfaces, measured at a height of 30 inches above floor level, during working hours (For visually difficult or critical tasks, additional lighting may be authorized by the GSA buildings manager or by agencies that have been given delegated authority to perform buildings management functions.);

(2) 30 foot-candles in work areas during working hours, measured at 30 inches above floor level;

(3) 10 foot-candles, but not less than 1 foot-candle nonwork areas, sufficient to ensure safety in non-work areas during working hours. (Normally this will require levels of 5 foot-candles at elevator boarding areas, minimum of 1 foot-candle at the middle of corridors and stairwells as measured at the walking surface, and 1 foot-candle at the middle of corridors and stairwells as measured at the walking surface, and 10 foot-candles in storage areas.); and

(4) Other lighting essential for safety and security purposes, including exit signs and exterior lights, shall be maintained.

(c) Within the limitations of the building systems, heating and cooling systems shall be operated in the most overall energy efficient and economical manner.

(1) Temperatures will be maintained to maximize customer satisfaction by conforming to local commercial equip-

ment temperature levels and operating practices. GSA will seek to minimize energy use while operating its buildings in this manner. During non-working hours, heating temperatures shall be set no higher than 55 degrees Fahrenheit and air-conditioning will not be provided except as necessary to return space temperatures to a suitable level for the beginning of working hours.

(2) The locations used for measurement of temperatures to determine compliance will be representative of the spaces to be heated or cooled.

(3) Work stations which are the most adversely affected may be the basis for establishing the temperature levels throughout that portion of the building.

(4) Reheating, humidification, and simultaneous heating and cooling shall not be permitted.

(5) During extreme weather conditions, building systems shall be operated as necessary to protect the physical condition of the building.

(d) The operation of portable heaters, fans, and other such devices in Government-controlled space is prohibited unless authorized by the GSA buildings manager or by agencies that have been given delegated authority to perform buildings management functions.

(e) During working hours in periods of heating and cooling, provide ventilation in accordance with ASHRAE Standard 62, *Ventilation for Acceptable Indoor Air Quality* where physically practical. Where not physically practical, provide the maximum allowable amount of ventilation during periods of heating and cooling and pursue opportunities to increase ventilation up to current standards. ASHRAE Standard 62 is available from ASHRAE Publications Sales, 1791 Tullie Circle NE, Atlanta, GA 30329-2305.

(f) Energy standards for existing buildings will be no less stringent than those prescribed by the American Society of Heating, Refrigerating, and Air Conditioning Engineers and the Illuminating Engineering Society of North America in ASHRAE/IES Standard 90A-1980 as amended by Department of Energy (DOE). These energy standards are applicable where they can be achieved through life cycle, cost effective actions.

§ 101-20.108

41 CFR Ch. 101 (7-1-01 Edition)

(g) Exceptions to the foregoing policies may be necessary for specialized requirements of for agencies to accomplish their missions more effectively and efficiently. Such exceptions may be granted by the GSA buildings manager or by agencies that have been given delegated authority to perform buildings management functions.

(h) Contracting officers shall ensure that all new lease contracts are in conformance with the policies prescribed in this §101-20.107. Existing lease contracts shall be administered in accordance with these policies to the maximum extent feasible.

(i) Each agency shall report to the Department of Energy (DOE) the energy consumption in buildings, facilities, vehicles, and equipment under its control within 45 calendar days after the end of each quarter as specified in the DOE Federal Energy usage Report DOE F 6200.2 instructions. This report has been cleared in accordance with FPMR 101-11.11,¹ Interagency Reports Management Program, and assigned interagency report control number 1492 DOE OU.

[52 FR 11263, Apr. 8, 1987; 52 FR 24158, July 29, 1987, as amended at 60 FR 17653, Apr. 7, 1995]

§ 101-20.108 Staggered hours of duty.

(a) The GSA Regional Administrator, National Capital Region, is responsible for putting into effect the policy of maintaining staggered duty hours in Metropolitan Washington, DC. For purposes of this regulation, "Metropolitan Washington" means the Washington Standard Metropolitan Statistical Area (SMSA) as defined by the Department of Commerce.

(b) Any agency planning a change in its schedule of duty hours which will affect 50 or more employees shall submit the changes to the GSA Regional Administrator, (WA) Washington, DC, 20407, for approval prior to implementation. The agency shall indicate the number of employees affected, the present and proposed hours of duty, and the reasons for the change in schedule. The agency shall also coordi-

nate with the employees and their union(s) to determine the percentage of employees in favor of the proposed change.

(c) The GSA Regional Administrator, National Capital Region, shall coordinate the proposed change with appropriate authorities to ensure that the change will not create congestion or disruptions in traffic or transportation flow patterns.

(d) GSA and other Federal agencies may also consider the advisability of establishing staggered duty hours in areas outside Metropolitan Washington where major concentrations of Federal employees exist.

§ 101-20.109 Concessions.

(a) The provisions of this section do not apply to blind vending facilities operated under the Randolph-Sheppard Act (20 U.S.C. 107 *et seq.*); regulations governing this program are continued in subpart 101-20.2.

(b) GSA is responsible for the planning, provision, and administration of essential concessions in buildings under its control. GSA will enter into and award concessions contracts, provide suitable space and facilities, if required, and administer applicable inspection and oversight functions. Officials of occupant agencies shall convey concerns to GSA and shall not instruct concessionaires regarding their operations.

(c) Subject to the availability of space, prior to establishing concessions, GSA will ensure that:

(1) The proposed concession will offer only essential services which are needed by employees, and which cannot be conveniently obtained from existing facilities, (Consultation will be held with occupant agencies.);

(2) The proposed concession will be established and operated in conformance with applicable policies, safety, health, and sanitation codes, laws, regulations, etc., and will not contravene the terms of any lease or other contractual arrangement;

(3) Sufficient funds are legally available to cover all costs for which the Government may be responsible; and

(4) All contracts will be financially self-supporting and not compete with nearby commercial enterprise.

¹EDITORIAL NOTE: At 50 FR 26908, June 28, 1985, 41 CFR part 101-11 was recodified as 41 CFR parts 201-22 and 201-45. The reference to FPMR 101-11.11 should read FIRM 201-45.6.

(d) Public Law 104-52, Section 636, prohibits the sale of tobacco products in vending machines in Government-owned and leased space under the custody and control of GSA. The Administrator of GSA or the head of an Agency may designate areas not subject to the prohibition, if the area prohibits minors and reports are made to the appropriate committees of Congress.

[52 FR 11263, Apr. 8, 1987, as amended at 61 FR 2122, Jan. 25, 1996]

Subpart 101-20.2—Vending Facility Program for Blind Persons

§ 101-20.200 Scope of subpart.

This subpart contains the policy and procedures for ensuring the priority of blind vendors in operating vending facilities on GSA-controlled property.

§ 101-20.201 Policy.

Blind vendors licensed by State licensing agencies designated by the Secretary of Education under the provisions of the Randolph-Sheppard Act (20 U.S.C. 107 *et seq.*) shall be given priority in the location and operating of vending facilities, including vending machines, on GSA-controlled property provided the location or operation of such facility would not adversely affect the interests of the United States. Blind vendors shall also be given priority on GSA-controlled property in the operation of cafeterias according to 34 CFR 395.33.

§ 101-20.202 Establishing vending facilities.

(a) GSA shall not acquire a building by ownership, rent, or lease, or occupy a building to be constructed, substantially altered, or renovated unless it is determined that such buildings contain or will contain a "satisfactory site" as defined in 34 CFR 395.1q, for the location and operating of a blind vending facility.

(b) In accordance with 34 CFR 395.31, GSA shall provide the appropriate State licensing agency with written notice of its intention to acquire or otherwise occupy such building. Providing notification shall be the responsibility of the Buildings Management Division, GSA.

§ 101-20.203 Application for permit.

Applications for permits for the operation of vending facilities other than cafeterias shall be made in writing on the appropriate form, and submitted for the review and approval of GSA.

§ 101-20.204 Terms of permit.

Every permit shall describe the location of the vending facility including any vending machines located on other than the facility premises and shall be subject to the following provisions:

(a) The permit shall be issued in the name of the applicant State licensing agency which shall:

(1) Prescribe such procedures necessary to assure that in the selection of vendors and employees for vending facilities there shall be no discrimination because of sex, race, age, creed, color, national origin, physical or mental disability, or political affiliation; and

(2) Take the necessary action to assure that vendors do not discriminate against any persons in furnishing, or by refusing to furnish, to such person or persons the use of any vending facility, including any and all services, privileges, accommodations, and activities provided thereby, and comply with title VI of the Civil Rights Act of 1964 and GSA regulations issued pursuant thereto.

(b) The permit shall be issued for an indefinite period of time subject to suspension or termination on the basis of compliance with agreed upon terms.

(c) The permit shall provide that:

(1) No charge shall be made to the State licensing agency for normal cleaning, maintenance, and repair of the building structure in and adjacent to the vending facility areas;

(2) Cleaning necessary for sanitation, and the maintenance of vending facilities and vending machines in an orderly condition at all times, and the installation, maintenance, repair, replacement, servicing, and removal of vending facility equipment shall be without cost to GSA; and

(3) Articles sold at vending facilities operated by blind licensees may consist of newspapers, periodicals, publications, confections, tobacco products,

§ 101-20.205

foods, beverages, chances for any lottery authorized by State law and conducted by an agency of a State within such State, and other articles or services as are determined by the State licensing agency, in consultation with GSA to be suitable for a particular location. Such articles and services may be dispensed automatically or manually and may be prepared on or off the premises. Public Law 104-52, Section 636, prohibits the sale of tobacco products in vending machines in Government-owned and leased space under the custody and control of GSA.

(d) The permit shall further provide that vending facilities shall be operated in compliance with applicable health, sanitation, and building codes or ordinances.

(e) The permit shall further provide that installation, modification, relocation, removal, and renovation of vending facilities shall be subject to the prior approval and supervision of the Director, Buildings Management Division, GSA, and the State licensing agency; that costs of relocations initiated by the State licensing agency shall be paid by the State licensing agency; that costs of relocations initiated by the Director, Buildings Management Division, shall be paid by GSA; and that all plumbing, electrical, and mechanical costs related to the renovation of existing facilities shall be paid by GSA.

(f) The operation of a cafeteria by a blind vendor shall be covered by a contractual agreement and not by a permit. The State licensing agency shall be expected to perform under the same contractual arrangement applicable to commercial cafeteria operators.

[52 FR 11263, Apr. 8, 1987, as amended at 61 FR 2122, Jan. 25, 1996]

§ 101-20.205 Enforcement procedures.

(a) The State licensing agency shall attempt to resolve day-to-day problems pertaining to the operation of the vending facility in an informal manner with the participation of the blind vendor and the buildings manager.

(b) Unresolved disagreements concerning the terms of the permit, the Act, or the regulations in this part and any other unresolved matters shall be reported in writing to the State licens-

41 CFR Ch. 101 (7-1-01 Edition)

ing agency supervisory personnel by the GSA regional office in an attempt to resolve the issue.

§ 101-20.206 Reports.

At the end of each fiscal year, GSA shall report to the Secretary of Education the total number of applications for vending facility locations received from State licensing agencies, the number accepted, the number denied, the number still pending, the total amount of vending machine income collected, and the amount of such vending machine income disbursed to the State licensing agency in each State.

Subpart 101-20.3—Conduct on Federal Property

§ 101-20.300 Applicability.

These rules and regulations apply to all property under the charge and control of the General Services Administration and to all persons entering in or on such property. Each occupant agency shall be responsible for the observance of these rules and regulations.

§ 101-20.301 Inspection.

Packages, briefcases, and other containers in the immediate possession of visitors, employees, or other persons arriving on, working at, visiting, or departing from Federal property, are subject to inspection. A full search of a person and any vehicle driven or occupied by the person may accompany an arrest.

§ 101-20.302 Admission to property.

Property shall be closed to the public during other than normal working hours. The closing of property will not apply to that space in those instances where the Government has approved the after-normal-working-hours use of buildings or portions thereof for activities authorized by subpart 101-20.4. During normal working hours, property shall be closed to the public only when situations require this action to ensure the orderly conduct of Government business. The decision to close the property shall be made by the designated official under the Occupant

Federal Property Management Regulations

§ 101-20.308

Emergency program after consultation with the buildings manager and the ranking representative of the Law Enforcement Branch responsible for protection of the facility or the area. The designated official is defined in §101-20.003(g) as the highest ranking official of the primary occupant agency, or the alternate highest ranking official or designee selected by mutual agreement by other occupant agency officials. When property, or a portion thereof, is closed to the public, admission to this property, or a portion, will be restricted to authorized persons who shall register upon entry to the property and shall, when requested, display Government or other identifying credentials to the Federal Protective Officers or other authorized individuals when entering, leaving, or while on the property. Failure to comply with any of the applicable provisions is a violation of these regulations.

[53 FR 129, Jan. 5, 1988]

§ 101-20.303 Preservation of property.

The improper disposal of rubbish on property; the willful destruction of or damage to property; the theft of property; the creation of any hazard on property to persons or things; the throwing of articles of any kind from or at a building or the climbing upon statues, fountains, or any part of the building, is prohibited.

§ 101-20.304 Conformity with signs and directions.

Persons in and on property shall at all times comply with official signs of a prohibitory, regulatory, or directory nature and with the lawful direction of Federal Protective Officers and other authorized individuals.

§ 101-20.305 Disturbances.

Any loitering, disorderly conduct, or other conduct on property which creates loud or unusual noise or a nuisance; which unreasonably obstructs the usual use of entrances, foyers, lobbies, corridors, offices, elevators, stairways, or parking lots; which otherwise impedes or disrupts the performance of official duties by Government employees; or which prevents the general public from obtaining the administrative

services provided on the property in a timely manner, is prohibited.

§ 101-20.306 Gambling.

Participating in games for money or other personal property or the operating of gambling devices, the conduct of a lottery or pool, or the selling or purchasing of numbers tickets, in or on property is prohibited. This prohibition shall not apply to the vending or exchange of chances by licensed blind operators of vending facilities for any lottery set forth in a State law and authorized by section 2(a)(5) of the Randolph-Sheppard Act (20 U.S.C. 107, *et seq.*)

§ 101-20.307 Alcoholic beverages and narcotics.

Operations of a motor vehicle while on the property by a person under the influence of alcoholic beverages, narcotic drugs, hallucinogens, marijuana, barbiturates, or amphetamines is prohibited. Entering upon the property, or while on the property, under the influence of or using or possessing any narcotic drugs, hallucinogens, marijuana, barbiturates, or amphetamines is prohibited. The prohibition shall not apply in cases where the drug is being used as prescribed for a patient by a licensed physician. Entering upon the property, or being on the property, under the influence of alcoholic beverages is prohibited. The use of alcoholic beverages on property is prohibited except, upon occasions and on property upon which the head of the responsible agency or his or her designee has for appropriate official uses granted an exemption in writing. The head of the responsible agency or his or her designee shall provide a copy of all exemptions granted to the buildings manager and the Chief, Law Enforcement Branch, or other authorized officials, responsible for the security of the property.

[53 FR 129, Jan. 5, 1988]

§ 101-20.308 Soliciting, vending, and debt collection.

Soliciting alms, commercial or political soliciting, and vending of all kinds, displaying or distributing commercial advertising, or collecting private debts on GSA-controlled property

§ 101-20.309

is prohibited. This rule does not apply to:

(a) National or local drives for funds for welfare, health, or other purposes as authorized by 5 CFR, parts 110 and 950, Solicitation of Federal Civilian and Uniformed Services Personnel for Contributions to Private Voluntary Organizations issued by the U.S. Office of Personnel Management under Executive Order 12353 of March 23, 1982, as amended, and sponsored or approved by the occupant agencies;

(b) Concessions or personal notices posted by employees on authorized bulletin boards;

(c) Solicitation of labor organization membership or dues authorized by occupant agencies under the Civil Service Reform Act of 1978 (Pub. L. 95-454); and

(d) Lessee, or its agents and employees, with respect to space leased for commercial, cultural, educational, or recreational use under the Public Buildings Cooperative Use Act of 1976 (40 U.S.C. 490(a)(16)).

NOTE: Public areas of GSA-controlled property may be used for other activities permitted in accordance with subpart 101-20.4.

[53 FR 130, Jan. 5, 1988]

§ 101-20.309 Posting and distributing materials.

(a) Public Law 104-52, Section 636, prohibits the distribution of free samples of tobacco products in or around Federal buildings.

(b) Posting or affixing materials, such as pamphlets, handbills, or flyers, on bulletin boards or elsewhere on GSA-controlled property is prohibited, except as authorized in §101-20.308 or when these displays are conducted as part of authorized Government activities. Distribution of materials, such as pamphlets, handbills, or flyers is prohibited, except in the public areas of the property as defined in §101-20.003(z), unless conducted as part of authorized Government activities. Any person or organization proposing to distribute materials in a public area under this section shall first obtain a permit from the building manager under Subpart 101-20.4 and shall conduct distribution in accordance with the provisions of Subpart 101-20.4. Fail-

41 CFR Ch. 101 (7-1-01 Edition)

ure to comply with those provisions is a violation of these regulations.

[61 FR 2122, Jan. 25, 1996]

§ 101-20.310 Photographs for news, advertising, or commercial purposes.

Photographs may be taken in space occupied by a tenant agency only with the consent of the occupying agency concerned. Except where security regulations apply or a Federal court order or rule prohibits it, photographs for news purposes may be taken in entrances, lobbies, foyers, corridors, or auditoriums when used for public meetings. Subject to the foregoing prohibitions, photographs for advertising and commercial purposes may be taken only with written permission of an authorized official of the agency occupying the space where the photographs are to be taken.

§ 101-20.311 Dogs and other animals.

Dogs and other animals, except seeing eye dogs, other guide dogs, and animals used to guide or assist handicapped persons, shall not be brought upon property for other than official purposes.

§ 101-20.312 Vehicular and pedestrian traffic.

(a) Drivers of all vehicles entering or while on property shall drive in a careful and safe manner at all times and shall comply with the signals and directions of Federal protective officers or other authorized individuals and all posted traffic signs;

(b) The blocking of entrances, drive-ways, walks, loading platforms, or fire hydrants on property is prohibited; and

(c) Except in emergencies, parking on property is not allowed without a permit. Parking without authority, parking in unauthorized locations or in locations reserved for other persons, or parking contrary to the direction of posted signs is prohibited. Vehicles parked in violation, where warning signs are posted, shall be subject to removal at the owners' risk and expense. This paragraph may be supplemented from time to time with the approval of the Regional Administrator by the issuance and posting of such specific traffic directives as may be required,

Federal Property Management Regulations

§ 101-20.402

and when so issued and posted such directives shall have the same force and effect as if made a part thereof. Proof that a motor vehicle was parked in violation of these regulations or directives may be taken as prima facie evidence that the registered owner was responsible for the violation.

§ 101-20.313 Explosives.

No person entering or while on property shall carry or possess explosives, or items intended to be used to fabricate an explosive or incendiary device, either openly or concealed, except for official purposes. (Weapons, see title 18, U.S. Code 930.)

[54 FR 15757, Apr. 19, 1989]

§ 101-20.314 Nondiscrimination.

There shall be no discrimination by segregation or otherwise against any person or persons because of race, creed, sex, color, or national origin in furnishing or by refusing to furnish to such person or persons the use of any facility of a public nature, including all services, privileges, accommodations, and activities provided thereby on the property.

§ 101-20.315 Penalties and other laws.

Whoever shall be found guilty of violating any rule or regulations in this subpart 101-20.3 while on any property under the charge and control of the U.S. General Services Administration is subject to a fine of not more than \$50 or imprisonment of not more than 30 days, or both (See title 40 U.S. Code 318c.) Nothing in these rules and regulations shall be construed to abrogate any other Federal laws or regulations or any State and local laws and regulations applicable to any area in which the property is situated (section 205(c), 63 U.S. Statutes, 390; 40 U.S. Code 486(c)).

[53 FR 130, Jan. 5, 1988]

Subpart 101-20.4—Occasional Use of Public Buildings

§ 101-20.400 Scope of subpart.

Sections 101-20.401 through 101-20.408 establish rules and regulations for the occasional use of public areas for cultural, educational and recreational ac-

tivities as provided by the Public Buildings Cooperative Use Act of 1976 (Pub. L. 94-541).

§ 101-20.401 Applications for permits.

(a) Any person or organization desiring to use a public area shall file an application for permit with the GSA Buildings Manager. Such application shall be made on a form provided by GSA and shall be submitted in the manner specified by GSA.

(b) The following information is required:

(1) Full names, mailing addresses, and telephone numbers of the applicant, the organization sponsoring the proposed activity, and the individual(s) responsible for supervising the activity;

(2) Documentation showing that the applicant has authority to represent the sponsoring organization;

(3) A description of the proposed activity, including the dates and times during which it is to be conducted and the number of persons to be involved.

(c) If the proposed activity constitutes a use of a public area for soliciting funds, the applicant shall also submit a signed statement that:

(1) The applicant is a representative of and will be soliciting funds for the sole benefit of, a religion or religious group; or

(2) The applicant's organization has received an official ruling of tax-exempt status from the Internal Revenue Service under 26 U.S.C. 501; or, alternatively, that an application for such a ruling is still in process.

§ 101-20.402 Permits.

(a) A permit shall be issued by GSA within 10 working days following its receipt of the completed applications. A permit shall not be issued for a period of time in excess of 30 calendar days, unless specifically approved by the regional officer. After the expiration of a permit, a new permit may be issued upon submission of a new application; in such a case, applicants may incorporate by reference all required information filed with the prior application.

(b) When more than one permit is requested for the same area and times, permits will be issued on a first-come, first-served basis.

§ 101-20.403

(c) All permits involving demonstrations and activities which may lead to civil disturbances should be coordinated with the Chief, Law Enforcement Branch, before approval.

§ 101-20.403 Disapproval of applications or cancellation of permits.

(a) GSA shall disapprove any application or cancel an issued permit if:

(1) The applicant has failed to submit all information required under § 101-20.401, or has falsified such information;

(2) The proposed use is a commercial activity as defined in § 101-20.003(d);

(3) The proposed use interferes with access to the public area, disrupts official Government business, interferes with approved uses of the property by tenants or by the public, or damages any property;

(4) The proposed use is intended to influence or impede any pending judicial proceeding;

(5) The proposed use is obscene within the meaning of obscenity as defined in 18 U.S.C. 1461-65; or

(6) The proposed use is violative of the prohibition against political solicitations in 18 U.S.C. 607.

(b) Upon disapproving an application or cancelling a permit, GSA shall promptly notify the applicant or permittee of the reasons for the action, and shall inform the applicant or permittee of his/her appeal rights under § 101-20.404.

[52 FR 11263, Apr. 8, 1987; 52 FR 24158, July 29, 1987]

§ 101-20.404 Appeals.

(a) A disapproval of application or cancellation of issued permits may be appealed to the GSA Regional Officer (as defined in § 101-20.003(m)) within 5 calendar days of the notification of disapproval or cancellation. Notices of appeal must be made in writing.

(b) On appeal, the applicant or permittee and the GSA buildings manager shall have opportunity to orally state their positions on the issues. Written materials may also be submitted.

(c) The GSA Regional Officer shall affirm or reverse the GSA building manager's decision, based on the information submitted, within 10 calendar days of the date on which the Regional

41 CFR Ch. 101 (7-1-01 Edition)

Officer received notification of the appeal. If the decision is not rendered within 10 days, the application will be considered to be approved or the permit validly issued. The Regional Officer will promptly notify the applicant or permittee and the buildings manager of the decision and the reasons therefor.

[52 FR 11263, Apr. 8, 1987; 52 FR 24158, July 29, 1987]

§ 101-20.405 Schedules of use.

Nothing in these regulations shall prevent GSA from reserving certain time periods for use of public areas for official Government business; from setting aside certain time periods for maintenance, repair, and construction; or from permitting a previously approved use for official Government business.

§ 101-20.406 Hours of use.

Public areas may be used during or after regular working hours of Federal agencies, provided that such uses will not interfere with Government business. When public areas are used by permittees after normal working hours, all adjacent areas not approved for such use shall be locked, barricaded, or identified by signs, as appropriate, to restrict permittees' activities to approved areas.

§ 101-20.407 Services and costs.

(a) *Costs.* The space to be provided under these regulations is furnished free of charge. Services normally provided at the building in question, such as security, cleaning, heating, ventilation, and air-conditioning, shall also be provided free of charge by GSA. The applicant shall be requested to reimburse GSA for services over and above those normally provided. If the applicant desires to provide services, such as security and cleaning, this request must be approved by the GSA Regional Officer. GSA may provide the services free of charge if the cost is insignificant and if it is in the public's interest.

(b) *Alterations.* Permittees shall make no alterations to public areas except with prior approval of GSA. Such approval shall not be given unless GSA determines that changes in a building should be made to encourage and aid in

Federal Property Management Regulations

Ch. 101, Subch. D, App.

the proposed use. Permittees making alterations must make provisions to ensure the safety of users and the prevention of damage to property.

(c) Permittees are responsible for furnishing items such as tickets, audiovisual equipment, etc., which are necessary for the proposed use.

§ 101-20.408 Conduct.

(a) Permittees are subject to all rules and regulations governing conduct on Federal property as set forth in subpart 101-20.3. In addition, a permittee shall:

(1) Not misrepresent his or her identity to the public;

(2) Not conduct any activities in a misleading or fraudulent manner;

(3) Not discriminate on the basis of race, creed, color, sex or national origin in conducting activities;

(4) Not distribute any item, nor post or otherwise affix any item, for which prior approval under § 101-20.401 has not been obtained;

(5) Not leave leaflets or other materials unattended on the property; and

(6) Not engage in activities which would interfere with the preferences afforded blind licenses under the Randolph-Sheppard Act (20 U.S.C. 107).

(b) Permittees engaging in the solicitation of funds as authorized by § 101-20.401 shall display identification badges while on Federal property. Each badge shall indicate the permittee's name, address, telephone number, and organization.

§ 101-20.409 Non-affiliation with the Government.

The General Services Administration reserves the right to advise the public through signs or announcements of the presence of any permittees and of their nonaffiliation with the Federal Government.

Subpart 101-20.5—Sidewalk Installation, Repair, and Replacement

§ 101-20.500 Scope of subpart.

This subpart contains the regulations governing the installation, repair, and replacement of sidewalks around buildings, installations, properties, or grounds under the control of executive

agencies and owned by the United States within the 50 States, the District of Columbia, the Commonwealth of Puerto Rico, and the territories and possessions of the United States, by reimbursement to a State or political subdivision thereof, the District of Columbia, the Commonwealth of Puerto Rico, or the territory or possession of the United States. They are issued with the approval of the Director of the Office of Management and Budget.

§ 101-20.501 Responsibilities.

Upon prior consent of the property-holding agency, the State in which the property lies may perform or arrange for the installation, repair, and replacement of sidewalks, and obtain reimbursement therefor from the property-holding agency, or, if mutually agreed upon, the property-holding agency may contract or otherwise arrange for and pay directly for such installation, repair, and replacement.

§ 101-20.502 Standards.

Sidewalks shall be installed, repaired, or replaced with due consideration to the standards and specifications prescribed by the State or political subdivision thereof. However, where the property-holding agency determines that it is necessary, in order to achieve or retain architectural harmony with the surroundings, the property-holding agency may prescribe other standards and specifications.

PART 101-21—FEDERAL BUILDINGS FUND

AUTHORITY: 40 U.S.C. 486(c); 40 U.S.C. 490(j) (The Federal Property and Administrative Services Act of 1949, as amended, Sec. 205(c) and 210(j), 63 Stat. 390 and 86 Stat. 219; (40 U.S.C. 486(c) and 40 U.S.C. 490(j), respectively).

SOURCE: 66 FR 23169, May 8, 2001, unless otherwise noted.

§ 101-21.000 Cross-reference to the Federal Management Regulation (FMR) (41 CFR chapter 102, parts 102-1 through 102-220.)

For information previously contained in this part, see FMR part 85 (41 CFR part 102-85).

APPENDIX TO SUBCHAPTER D—TEMPORARY REGULATIONS

[EDITORIAL NOTE: The following is a list of temporary regulations, except delegations of authority, which relate to Federal property management and are in effect as of the revision date of this volume. The full text of these temporary regulations appears following this table.]

FPMR Temp. Reg.	Subject	Expires	FR Publication
D-1	Assignment and utilization of space.	62 FR 42070, Aug. 5, 1997

FEDERAL PROPERTY MANAGEMENT REGULATIONS; INTERIM RULE D-1

Supplement 1

To: *Heads of Federal Agencies*

Subject: *Assignment and utilization of space*

1. *Purpose.* This interim rule, initially published in the FEDERAL REGISTER March 7, 1996, began the process of replacing part 101-17 of the Federal Property Management Regulations (FPMR). The rule repealed the outdated and superseded permanent FPMR part 101-17 and provided new guidance concerning the location of Federal facilities in urban areas. The rule expired on March 7, 1997. This supplement extends the interim rule indefinitely.

2. *Effective date.* March 8, 1997. Comments should be submitted on or before 30 calendar days following publication in the FEDERAL REGISTER.

3. *Comments.* Comments should be submitted to the General Services Administration, Public Buildings Service, Office of Property Acquisition and Realty Services (PE), Washington, DC 20405.

4. *Effect on other directives.* This interim rule amends 41 CFR part 101-17 by deleting all subparts and sections in their entirety and by adding a new §101-17.205 entitled "Location of Space."

Dated: April 21, 1992.

David J. Barram,
Acting Administrator of General Services

ATTACHMENT A

"Subchapter D—Public Buildings and Space

PART 101-17—ASSIGNMENT AND UTILIZATION OF SPACE

§101-17.000 Scope of part.

For more information on location of space, see 41 CFR parts 102-71 through 102-82. To the extent that any policy statements in this part are inconsistent with the policy statement in 41 CFR parts 102-71 through 102-82, the policy statements in 41 CFR parts 102-71 through 102-82 are controlling.

§101-17.205 Location of space

(a) Each Federal agency is responsible for identifying its geographic service area and the delineated area within which it wishes to locate specific activities, consistent with its mission and program requirements, and in accordance with all applicable statutes, reg-

ulations and policies. Specifically, under the Rural Development Act of 1972, as amended, 42 U.S.C. §3122, agencies are required to give first priority to the location of new offices and other facilities in rural areas. When agency mission and program requirements call for location in an urban area, agencies must comply with Executive Order 12072, August 16, 1978, 3 CFR 213 (1979), which requires that first consideration be given to central business areas (CBAs) and other designated areas. The agency shall submit to GSA a written statement explaining the basis for the delineated area.

(b) GSA shall survey agencies' mission, housing, and location requirements in a community and include these considerations in community-based policies and plans. These plans shall provide for the location of federally-owned and leased facilities, and other interests in real property including purchases, at locations which represent the best overall value to the Government consistent with agency requirements.

(c) Whenever practicable and cost-effective, GSA will consolidate elements of the same agency or multiple agencies in order to achieve the economic and programmatic benefits of consolidation.

(d)(1) GSA will consult with local officials and other appropriate Government officials and consider their recommendations for, and review of, general areas of possible space or site acquisition. GSA will advise local officials of the availability of data on GSA plans and programs, and will agree upon the exchange of planning information with local officials. GSA will consult with local officials to identify CBAs.

(2) With respect to an agency's request for space in an urban area, GSA shall provide appropriate Federal, State, regional, and local officials such notice as will keep them reasonably informed about GSA's proposed space action. For all proposed space actions with delineated areas either partially or wholly outside the CBA, GSA shall consult with such officials by providing them with written notice, by affording them a proper opportunity to respond, and by considering all recommendations for and objections to the proposed space action. All contacts with such officials relating to proposed space actions must be appropriately documented in the official procurement file.

(e) GSA is responsible for reviewing an agency's delineated area to confirm that, where appropriate, there is maximum use of existing Government-controlled space and that established boundaries provide competition when acquiring leased space.

(f) In satisfying agency requirements in an urban area, GSA will review an agency requested delineated area to ensure that the area is within the CBA. If the delineated area requested is outside the CBA, in whole or part, an agency must provide written justification to GSA setting forth facts and considerations sufficient to demonstrate that first consideration has been given to the CBA and to support the determination that the agency program function(s) involved cannot be efficiently performed within the CBA.

(g) Agency justifications for locating outside CBAs must address, at a minimum, the efficient performance of the missions and programs of the agencies, the nature and function of the facilities involved, the convenience of the public served, and the maintenance and improvement of safe and healthful working conditions for employees.

(h) GSA is responsible for approving the final delineated area. As the procuring agency, GSA must conduct all acquisitions in accordance with the requirements of all applicable laws, regulations, and Executive orders. GSA will review the identified delineated area to confirm its compliance with all applicable laws, regulations, and Executive orders, including the Rural Development Act of 1972, as amended, the Competition in Contracting Act, as amended, 41 U.S.C. §§252-266, and Executive Order 12072.

(i) Executive Order 12072 provides that "space assignments shall take into account the management needs for consolidation of agencies or activities in common or adjacent space in order to improve administration and management and effect economies." Justifications that rely on consolidation or adjacency requirements will be carefully reviewed for legitimacy.

(j) Executive Order 12072 directs the Administrator of General Services to "[e]nsure, in cooperation with the heads of Executive agencies, that their essential space requirements are met in a manner that is economically feasible and prudent." Justifications that rely on budget or other fiscal restraints for locating outside the CBA will be carefully reviewed for legitimacy.

(k) Justifications based on executive or personnel preferences or other matters which do not have a material and significant adverse impact on the efficient performance of agency program functions are not acceptable.

(l) In accordance with the Competition in Contracting Act, GSA may consider whether restricting the delineated area to the CBA will provide for competition when acquiring

leased space. Where it is determined that an acquisition should not be restricted to the CBA, GSA may expand the delineated area in consultation with the requesting agency and local officials. The CBA must continue to be included in such an expanded area.

(m) If, based on its review of an agency's requested delineated area, GSA concludes that changes are appropriate, GSA will discuss its recommended changes with the requesting agency. If after discussions the requesting agency does not agree with GSA's delineated area recommendation, the agency may take the steps described below. If an agency elects to request a review of the GSA's delineated area recommendation, GSA will continue to work on the requirements development and other activities related to the requesting agency's space request. GSA will not issue a solicitation to satisfy an agency's space request until all requested reviews have been resolved.

(1) For space actions of less than 25,000 square feet, an agency may request a review of GSA's delineated area recommendation by submitting a written request to the responsible Assistant Regional Administrator for the Public Buildings Service. The request for review must state all facts and other considerations and must justify the requesting agency's proposed delineated area in light of Executive Order 12072 and other applicable statutes, regulations, and policies. The Assistant Regional Administrator will issue a decision within fifteen (15) working days. The decision of the Assistant Regional Administrator will be final and conclusive.

(2) For space actions of 25,000 square feet or greater, a requesting agency may request a review of GSA's delineated area recommendation by submitting a written request to the Commissioner of the Public Buildings Service that the matter be referred to an interagency council for decision. The interagency council will be established specifically to consider the appeal and will be comprised of the Administrator of General Services or his/her designee, the Secretary of Housing and Urban Development, or his/her designee, and such other Federal official(s) as the Administrator may appoint.

(n) The presence of the Federal Government in the National Capital Region (NCR) is such that the distribution of Federal installations will continue to be a major influence in the extent and character of development. These policies shall be applied in the GSA National Capital Region, in conjunction with regional policies established by the National Capital Planning Commission and consistent with the general purposes of the National Capital Planning Act of 1959 (66 Stat. 781), as amended. These policies shall guide the development of strategic plans for the housing of Federal agencies within the National Capital Region.

Ch. 101, Subch. D, App.

41 CFR Ch. 101 (7-1-01 Edition)

(o) Consistent with the policies cited in paragraphs (a), (b), (c) and (e) above, the use of buildings of historic architectural, or cultural significance within the meaning of section 105 of the Public Buildings Cooperative Use Act of 1976 (90 Stat. 2505) will be considered as alternative sources for meeting Federal space needs.

(p) As used in §101-17.205, the following terms have the following meanings:

(1) "CBA" means the centralized community business area and adjacent areas of similar character, including other specific areas which may be recommended by local officials in accordance with Executive order 12072.

(2) "Delineated area" means the specific boundaries within which space will be obtained to satisfy an agency space requirement.

(3) "Rural area" means any area that (i) is within a city or town if the city or town has a population of less than 10,000 or (ii) is not within the outer boundaries of a city or town if the city or town has a population of 50,000 or more and if the adjacent urbanized and urbanizing areas have a population density of more than 100 per square mile.

(4) "Urban area" means any Metropolitan Area (MA) as defined by the Office of Management and Budget (OMB) and any non-MA that meets one of the following criteria:

(i) A geographical area within the jurisdiction of any incorporated city, town, borough, village, or other unit of general local government, except county or parish, having a population of 10,000 or more inhabitants.

(ii) That portion of the geographical area within the jurisdiction of any county, town, township, or similar governmental entity which contains no incorporated unit of general local government, but has a population density equal to or exceeding 1,500 inhabitants per square mile; or

(iii) That portion of any geographical area having a population density equal to or exceeding 1,500 inhabitants per square mile and situated adjacent to the boundary of any incorporated unit of general local government which has a population of 10,000 or more inhabitants. (Reference: Intergovernmental Cooperation Act of 1968, 40 U.S.C. 535.)

[39 FR 23196, June 27, 1974, as amended at 66 FR 5359, Jan. 18, 2001]

SUBCHAPTER E—SUPPLY AND PROCUREMENT

PARTS 101-22—101-24 [RESERVED]

PART 101-25—GENERAL

Sec.

- 101-25.000 Scope of subchapter.
- 101-25.001 Scope of part.

Subpart 101-25.1—General Policies

- 101-25.100 Use of Government personal property and nonpersonal services.
- 101-25.101 Criteria for determining method of supply.
 - 101-25.101-1 General.
 - 101-25.101-2 Supply through storage and issue.
 - 101-25.101-3 Supply through consolidated purchase for direct delivery to use points.
 - 101-25.101-4 Supply through indefinite quantity requirement contracts.
 - 101-25.101-5 Supply through local purchase.
- 101-25.102 Exchange or sale of personal property for replacement purposes.
- 101-25.103 Promotional materials, trading stamps, or bonus goods.
 - 101-25.103-1 General.
 - 101-25.103-2 Promotional material received in conjunction with official travel from transportation companies, rental car companies, or other commercial activities.
 - 101-25.103-3 Trading stamps or bonus goods received from contractors.
 - 101-25.103-4 Disposition of promotional materials, trading stamps, or bonus goods
- 101-25.104 Acquisition of office furniture and office machines.
 - 101-25.104-1 Redistribution, repair, or rehabilitation.
- 101-25.105 [Reserved]
- 101-25.106 Servicing of office machines.
- 101-25.107 Guidelines for requisitioning and proper use of consumable or low cost items.
- 101-25.108 Multiyear subscriptions for publications.
- 101-25.109 Laboratory and research equipment.
 - 101-25.109-1 Identification of idle equipment.
 - 101-25.109-2 Equipment pools.
- 101-25.110 Tire identification/registration program.
 - 101-25.110-1 [Reserved]
 - 101-25.110-2 Tires obtained through Federal Supply Schedules or regional term contracts.
 - 101-25.110-3 Tires accompanying new motor vehicles.
 - 101-25.110-4 Recordkeeping responsibilities.

- 101-25.111 Environmental impact policy.
- 101-25.112 Energy conservation policy.
- 101-25.113 [Reserved]
- 101-25.114 Supply management surveys and assistance.

Subpart 101-25.2—Interagency Purchase Assignments

- 101-25.201 General.
- 101-25.202 Factors to be used to determine assignment of purchase responsibility.
- 101-25.203 Centralized purchases by GSA.
- 101-25.204 Centralized purchases by designated executive agencies under authority delegated by the Administrator of General Services.
- 101-25.205 Arrangement for performance of purchasing functions other than centralized.
- 101-25.206 Independent purchases by executive agencies.

Subpart 101-25.3—Use Standards

- 101-25.301 General.
- 101-25.302 Office furniture, furnishings, and equipment.
 - 101-25.302-1 [Reserved]
 - 101-25.302-2 Filing cabinets.
 - 101-25.302-3—101-25.302-4 [Reserved]
 - 101-25.302-5 Carpeting.
 - 101-25.302-6 [Reserved]
 - 101-25.302-7 Draperies.

Subpart 101-25.4—Replacement Standards

- 101-25.401 General.
- 101-25.402 Motor vehicles.
- 101-25.403 [Reserved]
- 101-25.404 Furniture.
 - 101-25.404-1 Limitation.
- 101-25.405 Materials handling equipment.

Subpart 101-25.5—Purchase or Lease Determinations

- 101-25.500 Cross-reference to the Federal Acquisition Regulation (FAR) (48 CFR chapter 1, parts 1-99).

Subparts 101-25.6—101-25.49 [Reserved]

AUTHORITY: Sec. 205(c), 63 Stat. 390; 40 U.S.C. 486(c).

§ 101-25.000 Scope of subchapter.

This subchapter provides policies and guidelines pertaining to the general area of supply management designed to support the logistical programs of the Federal Government. It consists of parts 101-25 through 101-34 and provides

§ 101-25.001

for applicability of coverage within each of these several parts.

[29 FR 13256, Sept. 24, 1964]

§ 101-25.001 Scope of part.

This part provides policies and guidelines pertaining to subject matter in the general area of supply management which is not appropriate for coverage in other parts of this subchapter E.

[29 FR 13256, Sept. 24, 1964]

Subpart 101-25.1—General Policies

SOURCE: 29 FR 13256, Sept. 24, 1964, unless otherwise noted.

§ 101-25.100 Use of Government personal property and nonpersonal services.

Except in emergencies, Government personal property and nonpersonal services shall be used only for those purposes for which they were obtained or contracted for or other officially designated purposes. Emergency conditions are those threatening loss of life and property. As used in this section *nonpersonal services* means those contractual services, other than personal and professional services (as defined in 40 U.S.C. 472). This includes property and services on interagency loan as well as property leased by agencies. Agency heads shall ensure that the provisions of this §101-25.100 are enforced to restrict the use of Government property/services to officially designated activities.

[40 FR 29818, July 16, 1975]

§ 101-25.101 Criteria for determining method of supply.

§ 101-25.101-1 General.

(a) This §101-25.101 prescribes general criteria governing selection of the appropriate methods of supply to be utilized in meeting the planned requirements of the Government. It is directly applicable to executive agencies, and other Federal agencies are requested to observe these criteria in conducting their supply operations.

(b) As used in this §101-25.101, the term *use point* means a storeroom or other redistribution point where sup-

41 CFR Ch. 101 (7-1-01 Edition)

plies, materials, or equipment representing more than a 30-day supply are maintained primarily for issue directly to consumers within the local area, as distinguished from storage points where supplies and equipment are issued to redistribution points.

§ 101-25.101-2 Supply through storage and issue.

The following criteria shall govern in determining whether an item can be most advantageously supplied through storage and issue to use points:

(a) The item shall be physically adaptable to storage and issue and of such a character that it is feasible to forecast overall requirements of the use points served with reasonable accuracy;

(b) Rate of use and frequency of ordering at use points shall be sufficient to warrant storage and issue;

(c) The rate of deterioration or obsolescence shall be sufficiently low to avoid unnecessary loss; and

(d) Conditions exist where any of the following factors require supply through storage and issue (except that dangerous commodities of high weight and density, or commodities highly susceptible to damage normally should not be considered for supply through storage and issue unless one or more of such factors are determined to be of overriding importance)—

(1) Where price advantage through bulk buying is sufficient to render storage and issue more economical, all costs, both direct and indirect, considered.

(2) Where close inspection or testing is necessary to secure quality, or where repetitive inspection and test of small lots are prohibitive from the standpoint of cost or potential urgency of need.

(3) Where advance purchase and storage are necessitated by long procurement leadtime.

(4) Where an item is of special manufacture or design and is not readily available from commercial sources.

(5) Where an adequate industry distribution system does not exist to assure availability at use point.

(6) Where volume purchases are necessary to secure timely deliveries and advantageous prices.

Federal Property Management Regulations

§ 101-25.101-5

(7) Where market conditions are such that supply through storage and issue is required to assure adequate supply.

(8) Where stocking of supplies and equipment necessary for implementation of emergency plans is required for an indefinite period.

§ 101-25.101-3 Supply through consolidated purchase for direct delivery to use points.

The following criteria shall govern in determining whether an item can be most advantageously supplied through consolidated purchase for direct delivery to use points:

(a) The items shall be equipment or supply items of such a character that it is feasible to forecast requirements for delivery to specific use points; and

(b) Conditions exist where any of the following factors requires consolidated purchasing of such items for direct delivery to use points—

(1) Where greatest price advantage, both direct and indirect costs considered, is obtainable through large definite quantity purchasing.

(2) Where an item is of special manufacture or design and is not readily available from commercial sources.

(3) Where market conditions are such that central procurement is required to assure adequate supply.

(4) Where contracts for production quantities are necessary to secure timely deliveries and advantageous prices.

(5) Where the quantity is large enough to assure lowest transportation costs or, conversely, where transportation costs for small quantity redistribution are so excessive that it is not feasible to store and issue the items.

§ 101-25.101-4 Supply through indefinite quantity requirement contracts.

The following criteria shall govern in determining whether an item can be most advantageously supplied through the medium of indefinite quantity requirement contracts covering specific periods and providing for delivery to use points as needs arise:

(a) The item shall be such a character that—

(1) Handling on a storage and issue basis is not economically sound, under the criteria prescribed in § 101-25.101-2;

(2) Rate of use and frequency of ordering at use points is estimated to be sufficient to warrant the making of indefinite quantity requirement contracts;

(3) It is either not feasible to forecast definite requirements for delivery to specific use points (as in the case of new items initially being introduced into a supply system), or no advantage accrues doing so; and

(b) Industry distribution facilities are adequate properly to serve the use points involved; and

(c) Conditions exist where any of the following factors requires the maintaining of indefinite quantity requirements contracts—

(1) Advantage to the Government is greater than would be secured by definite quantity procurements by individual offices or agencies (the determining consideration being one of overall economy to the Government, rather than one of direct comparison of unit prices of individual items obtainable through other methods of supply); or no known procurement economies would be effected but the requirements of offices of agencies can best be served by indefinite quantity requirements contracts.

(2) Acute competitive bidding problems exist because of highly technical matters which can best be met on a centralized contracting basis.

(3) The item is proprietary or so complex in design, function, or operation as to be noncompetitive and procurement can best be performed on a centralized contracting basis.

§ 101-25.101-5 Supply through local purchase.

The following criteria shall govern in determining whether an item should be supplied through local purchase:

(a) Urgency of need requires local purchase to assure prompt delivery;

(b) The items are perishable or subject to rapid deterioration which will not permit delay incident to shipment from distant points;

(c) The local purchase is within applicable limitation established by the agency head; or

(d) Local purchase will produce the greatest economy to the Government.

§ 101-25.102

§ 101-25.102 Exchange or sale of personal property for replacement purposes.

Policies and methods governing executive agencies in exercising the authority granted under section 201(c) of the Federal Property and Administrative Services Act of 1949, as amended (40 U.S.C. 481(c)), are prescribed in part 101-46.

[31 FR 4997, Mar. 26, 1966]

§ 101-25.103 Promotional materials, trading stamps, or bonus goods.

§ 101-25.103-1 General.

Federal agencies in a position to receive promotional materials, trading stamps, or bonus goods shall establish internal procedures for the receipt and disposition of these gratuities in accordance with § 101-25.103. The procedures shall provide for a minimum of administrative and accounting controls.

[48 FR 48232, Oct. 18, 1983]

§ 101-25.103-2 Promotional material received in conjunction with official travel from transportation companies, rental car companies, or other commercial activities.

(a) All promotional materials (e.g., bonus flights, reduced-fare coupons, cash, merchandise, gifts, credits toward future free or reduced costs of services or goods, etc.) received by employees in conjunction with official travel and based on the purchase of a ticket or other services (e.g. car rental) are properly considered to be due the Government and may not be retained by the employee. The Comptroller General of the United States has stated that employees are obligated to account for any gift, gratuity, or benefit received from private sources incident to the performance of official duties (see Comp. Gen. Decision B-199656, July 15, 1981). When an employee receives promotional material, the employee shall accept the material on behalf of the United States and relinquish it to an appropriate agency official.

(b) Promotional coupons that provide for future free or reduced costs of services (travel) should be integrated into the agency travel plans to maximize the benefits to the Government. The

41 CFR Ch. 101 (7-1-01 Edition)

coupons should then be applied to the maximum extent possible; e.g., coast-to-coast or overseas travel, if permitted.

(c) Promotional coupons that carry a cash surrender value shall be redeemed immediately. The cash received from redeemed coupons or other cash compensation (i.e., denied boarding or cancellation of reservation by carriers, etc.) shall be deposited in accordance with Department of Treasury requirements, and credited to miscellaneous receipt account 1699, "Miscellaneous Dividends and Earnings, Not Otherwise Classified."

(d) Promotional materials that cannot be used by the receiving agency shall be disposed of in accordance with § 101-25.103-4.

[48 FR 48232, Oct. 18, 1983]

§ 101-25.103-3 Trading stamps or bonus goods received from contractors.

When contracts contain a price reduction clause, any method (such as trading stamps or bonus goods) by which the price of a commodity or service is effectively reduced shall constitute a price reduction. Temporary or promotional price reductions are to be made available to contracting officers under the same terms and conditions as to other customers. Procuring activities, however, rather than accept trading stamps and bonus goods, shall attempt to deduct the cost of such items from the contract price. If obtaining such a price reduction is not possible, the contracting officer shall document the contract file to that effect and dispose of the items as provided in § 101-25.103.4.

[48 FR 48232, Oct. 18, 1983]

§ 101-25.103-4 Disposition of promotional materials, trading stamps, or bonus goods.

(a) Agencies shall, through the lowest appropriate activity, arrange for transfer of promotional materials, trading stamps, or bonus goods, without reimbursement in accordance with internal agency procedures to a nearby Federal hospital or similar institution operated, managed, or supervised by the Department of Defense (DOD) or

Federal Property Management Regulations

§ 101-25.106

the Veterans Administration (VA) when:

(1) The contract does not contain a price reduction clause, or

(2) The contractor refuses to grant a price reduction, and

(3) It is deemed practical and in the best interest of the Government to accept such promotional items as a price reduction, and

(4) The procuring or receiving agency has no practical use for the promotional items.

(b) Before transferring promotional materials, trading stamps, or bonus goods to the above Federal institutions, it must be determined that the proposed recipient is prepared to receive and use such items. If these items cannot be used by the receiving agency or a medical facility, they should be disposed of in accordance with 41 CFR 101-43, 44 and 45.

[48 FR 48232, Oct. 18, 1983]

§ 101-25.104 Acquisition of office furniture and office machines.

Each executive agency shall make a determination as to whether the requirements of the agency can be met through the utilization of already owned items prior to the acquisition of new furniture or office machines. The acquisition of new items shall be limited to those requirements which are considered absolutely essential and shall not include upgrading to improve appearance, office decor, or status, or to satisfy the desire for the latest design or more expensive lines.

(a) Generally acquisition of additional furniture or office machines from any source will be authorized only under the following circumstances, limited to the least expensive lines which will meet the requirement (see §101-26.408 of this chapter with respect to items such as typewriters under Federal Supply Schedule contracts), and the justification for the action shall be fully documented in the agency file:

(1) For essential requirements arising from quantitative increases in onboard employment which constitute the total requirement of any agency or major component thereof (e.g. bureau, service, office).

(2) For essential requirements arising from a need not related to onboard employment increases but which are determined necessary to avoid impairment of program efficiency.

(b) Each agency shall restrict replacement of furniture or office machines either to usable excess, rehabilitated, or the least expensive new lines available which will meet the requirement under the following circumstances, authority for which will meet the requirement under the following circumstances, authority for which shall be fully documented in the agency file:

(1) Where the agency determines that the item is not economically repairable.

(2) Where reductions in office space occupancy are accomplished through use of more convenient or smaller size furniture and the space economies thus achieved offset the cost of the furniture to be acquired.

[30 FR 5479, Apr. 16, 1965, as amended at 42 FR 1031, Jan. 5, 1977]

§ 101-25.104-1 Redistribution, repair, or rehabilitation.

Prior to the purchase of new office furniture and office machines, agencies shall fulfill needs insofar as practicable through redistribution, repair, or rehabilitation of already owned furniture and office machines. In furtherance of the use of rehabilitated furniture and office machines, agencies shall review inventories on a continuing basis to ascertain those items which can be economically rehabilitated and institute programs for their orderly repair and rehabilitation. All such items which are not required for immediate needs shall be reported as excess.

[42 FR 1031, Jan. 5, 1977]

§ 101-25.105 [Reserved]

§ 101-25.106 Servicing of office machines.

(a) The determination as to whether office machines are to be serviced by use of annual maintenance contracts or per-call arrangements shall be made in each case after comparison of the relative cost affecting specific types of equipment in a particular location and

§ 101-25.107

41 CFR Ch. 101 (7-1-01 Edition)

consideration of the factors set forth in paragraph (b) of this section.

(b) Prior to making the determination required by paragraph (a) of this section, consideration shall be given to:

- (1) Standard of performance required;
- (2) Degree of reliability needed;
- (3) Environmental factors; i.e., dusty surroundings or other unfavorable conditions;
- (4) Proximity to available repair facilities;
- (5) Past experience with service facility; i.e., reputation, performance record, quality of work, etc.;
- (6) Daily use (heavy or light) and operator's care of machine;
- (7) Age and performance record of machine;
- (8) Machine inventory in relation to operating needs; i.e., availability of reserve machine in case of breakdown;
- (9) Number of machines; including overall frequency of repairs required;
- (10) Security restrictions, if any; and
- (11) Other pertinent factors.

[31 FR 14260, Nov. 4, 1966]

§ 101-25.107 Guidelines for requisitioning and proper use of consumable or low cost items.

Consumable and low value items in inventory (cupboard stocks are not considered inventory) are subject to accounting and inventory record controls in accordance with applicable provisions of law and the principles and standards prescribed by the General Accounting Office, 2 GAO 12.5. Normally, however, the systems of control for such property cease at the time of issuance from a warehouse or store-room to the consumer.

(a) The guidelines set forth in this §101-25.107 are considered minimum to assure proper use of consumable or low cost items by individuals, subsequent to issue from accountable records and termination of formal accountability. Consumable items, for the purpose of this section, are considered to include those items actually consumed in use (e.g., pads and pencils) and those items required in performance of duties but for which, primarily by reason of the low value involved, no formal accountability is maintained after issue, and

are generally referred to as "expendable."

(b) Approval of requisitions for replenishment of cupboard storeroom stocks should be restricted to officials at a responsible supervisory level to ensure that supply requirements are justified on the basis of essentiality and quantity. Where requisitions are not required, such as in obtaining items from GSA customer supply centers, informal "shopping lists" should be approved at the same level.

(c) Adequate safeguards and controls should be established to assure that issues of expendable supplies are made for official use only. In appropriate situations, this will include identification of individuals to whom expendable supplies have been issued. Experience has indicated, also, that certain items of expendables should not be displayed either at seasonal periods of the year or on a permanent basis.

(d) The items listed below have from experience proven to be personally attractive and particularly susceptible to being used for other than official duties. Agencies should give special attention to these and any other consumable or low cost items when issues are excessive when compared with normal program needs.

Attache cases, Ball point pens and refills, Brief cases, Binders, Carbon paper, Dictionaries, Felt tip markers, Felt tip pens and refills, File folders, Letterex, Letter openers, Pads (paper), Paper clips, Pencils, Pencil sharpeners, Portfolios (leather, plastic, and writing pads), Rubber bands, Rulers, Scissors, Spray paint and lacquer, Staplers, Staples, Staple removers, Tape dispensers, Transparent tape, Typewriter ribbons.

[32 FR 4413, Mar. 23, 1967, as amended at 42 FR 1031, Jan. 5, 1977; 51 FR 13498, Apr. 21, 1986]

§ 101-25.108 Multiyear subscriptions for publications.

Subscriptions for periodicals, newspapers, and other publications for which it is known in advance that a continuing requirement exists should be for multiple years rather than for a single year where such method is advantageous for the purpose of economy or otherwise. Where various bureaus or

Federal Property Management Regulations

§ 101-25.109-2

offices in the same agency are subscribing to the same publication, consideration shall be given to consolidating these requirements, to the extent practical, on an agency-wide basis and on a multiyear basis. Payment covering issues to be delivered during the entire subscription period may be made in advance from currently available appropriations (31 U.S.C. 530a).

[33 FR 17140, Nov. 19, 1968]

§ 101-25.109 Laboratory and research equipment.

(a) This section prescribes controls for use by Federal agencies in managing laboratory and research equipment in Federal laboratories. Agencies may establish such additional controls as are appropriate to increase the use of already-owned equipment instead of procuring similar equipment.

(b) The term *Federal laboratory*, as used in this section, means any laboratory or laboratory facility in any Government-owned or -leased building which is equipped and/or used for scientific research, testing, or analysis, except clinical laboratories operating in direct support of Federal health care programs. To the extent practicable, agencies should observe the provisions of this section with regard to commercial laboratories and laboratory facilities which operate under contract with the Government and use Government-furnished equipment.

[43 FR 29004, July 5, 1978]

§ 101-25.109-1 Identification of idle equipment.

(a) The provisions of this § 101-25.109-1 apply to all Federal laboratories regardless of size.

(b) Inspection tours of Federal laboratories shall be conducted on a scheduled basis, annually, if feasible, but no less than every 2 years, for the purpose of identifying idle and unneeded laboratory and research equipment. Following each tour, a report of findings shall be prepared by the inspection team and, as determined by the agency head or his designee, submitted to the head of the laboratory or to a higher agency official having laboratories management responsibility. Equipment identified by the in-

spection team as idle or unneeded shall be reassigned as needed within the laboratory, placed in an equipment pool, or declared excess and made available to other agencies in accordance with part 101-43.

(c) Laboratory inspection teams shall be comprised of senior program management, property management, and scientific personnel who are familiar with the plans and programs of the laboratory(ies) and who have a knowledge of laboratory and research equipment utilization. As determined by the agency head or his designee, members of an inspection team shall be appointed by either the head of the laboratory or a higher agency official having laboratories management responsibility.

(d) The agency head or his designee shall ensure compliance by responsible personnel with the requirements of this § 101-25.109-1 and shall require that periodic independent reviews of walk-through procedures employed in Federal laboratories under his control be conducted to determine their effectiveness and to effect modifications as appropriate.

[43 FR 29004, July 5, 1978]

§ 101-25.109-2 Equipment pools.

(a) The provisions of this § 101-25.109-2 apply to Federal laboratories which occupy an area of 10,000 square feet or more and employ 25 or more technical or scientific personnel.

(b) Equipment pools shall be established in Federal laboratories so that laboratory and research equipment can be shared or allocated on a temporary basis to laboratory activities and individuals whose average use does not warrant the assignment of the equipment on a permanent basis. In determining the number and location of equipment pools, consideration shall be given to economy of operation, mobility of equipment, accessibility to users, frequency of use of the equipment, and impact on research programs. Pooling operations should begin expeditiously, within 120 days, if feasible, following decisions regarding the number and location of pools. If it is determined that an equipment pool would not be practical or economical or for any other reason is not needed at a particular laboratory, a written report supporting

§ 101-25.110

that determination shall be submitted to the agency head or his designee. Federal laboratories which do not meet the size and staffing criteria in §101-25.109-2(a) should also establish equipment pools whenever feasible; however, these facilities need not submit written reports regarding determinations not to establish pools.

(c) Where the establishment of a physical pool would be economically unfeasible due to excessive transportation and handling costs, limited personnel resources, or limited space, pooling may be accomplished by means of equipment listings. Consideration should be given to the establishment of a laboratory advisory committee consisting of technical and management personnel to determine the types of equipment to be shared or pooled and to identify equipment that is no longer required.

(1) Equipment pools may also be used to fill requests for temporary replacements while permanently assigned equipment is being repaired or to provide equipment for new laboratories pending acquisition of permanent equipment.

(2) Although specific pieces of laboratory equipment may not be available for assignment to equipment pools, they may be available for sharing or loan. Information concerning the availability of this equipment can be maintained at a central location such as the equipment pools.

(d) Unless determined unnecessary by the agency head or his designee, each Federal laboratory operating equipment pools shall prepare and submit to the agency head or his designee an annual report concerning the use and effectiveness of equipment pooling.

(e) The agency head or his designee shall ensure compliance by responsible personnel with the provisions of this §101-25.109-2 and shall require that periodic independent reviews of equipment pool operations in Federal laboratories under his control be conducted to determine their effectiveness and to effect modifications as appropriate.

[43 FR 29004, July 5, 1978]

41 CFR Ch. 101 (7-1-01 Edition)

§ 101-25.110 **Tire identification/registration program.**

The regulations issued by the Department of Transportation in 49 CFR part 574, Tire Identification and Recordkeeping, require that tire manufacturers maintain or have maintained for them the name and address of tire purchasers, the identification number of each tire sold, and the name and address of the tire seller (or other means by which the manufacturer can identify the tire seller). In addition, distributors and dealers are required to furnish such data to manufacturers in connection with purchases made directly from them. GSA provides support to the Federal Government for tires, and therefore has prescribed the following procedures for tires purchased from or through GSA supply sources.

[53 FR 11848, Apr. 11, 1988]

§ 101-25.110-1 **[Reserved]**

§ 101-25.110-2 **Tires obtained through Federal Supply Schedules or regional term contracts.**

When tire manufacturers ship tires direct against orders placed under Federal Supply Schedules, the tire manufacturer will record the name and address of the purchaser and the identification numbers of the tires involved.

[53 FR 11848, Apr. 11, 1988]

§ 101-25.110-3 **Tires accompanying new motor vehicles.**

The tire identifications and recordkeeping regulations issued by the Department of Transportation require each motor vehicle manufacturer or his designee to maintain a record of tires on or in each vehicle shipped by him together with the name and address of the first purchaser.

[37 FR 7794, Apr. 20, 1972]

§ 101-25.110-4 **Recordkeeping responsibilities.**

The effectiveness of the tire identification and recordkeeping regulations depends on the active support and cooperation of all agencies to ensure that tires subject to a recall program are not to continue in service thereby endangering the lives of the occupants of

Federal Property Management Regulations

§ 101-25.114

the vehicle. Therefore, agencies should establish procedures for promptly identifying and locating all tires whether in storage or on vehicles so that advice from GSA, the tire manufacturer, or the vehicle manufacturer may be acted upon expeditiously.

[53 FR 11848, Apr. 11, 1988]

§ 101-25.111 Environmental impact policy.

(a) From time to time, Congress enacts legislation pertaining to the protection and enhancement of the Nation's environment; e.g., the National Environmental Policy Act of 1969 (42 U.S.C. 4321). The objective of such legislation is, among other things, the improvement of the relationship between people and their environment and the lessening of hazards affecting their health and safety. It is the policy of the General Services Administration to appropriately implement the various provisions of these Acts of Congress as fully as statutory authority permits in support of the national policy.

(b) With respect to the procurement, management, and disposal of personal property, the implementation of national environmental policy is provided through amendments to the regulations of GSA, changes to Federal specifications and standards documents, as appropriate, and other actions as may be required when expediency is of prime importance. Further, the Federal regulatory agencies have imposed restrictions applicable to the procurement, use, and disposal of items supplied through the Federal supply system that are known to contain components or possess qualities that have an adverse impact on the environment or that result in creating unsafe or unhealthy working conditions. Each agency, therefore, shall take action as necessary to ensure that the objectives and directives of the National Environmental Policy Act, other environmental statutes, and applicable regulations are met; especially the directive that environmental concerns, effects, and values shall be given appropriate consideration with economic and technical issues in decisionmaking. Action should include a continuing review of the FEDERAL REGISTER and issuances

promulgated by the Federal regulatory agencies for guidance applicable to the procurement, use, and disposal of items that are known to contain components or to possess qualities that have an adverse impact on the environment or that result in creating unsafe or unhealthy working conditions.

[39 FR 24505, July 3, 1974]

§ 101-25.112 Energy conservation policy.

(a) Agency officials responsible for procurement, management, and disposal of personal property and nonpersonal services shall ensure that pertinent procurement and property management documents reflect the policy set forth in paragraph (b) of this section, which has been established pursuant to Public Law 94-163, Energy Policy and Conservation Act.

(b) With respect to the procurement or lease of personal property or nonpersonal services, which in operation consume energy or contribute to the conservation of energy, executive agencies shall promote energy conservation and energy efficiency by being responsive to the energy efficiency and/or conservation standards or goals prescribed by the U.S. Government.

[43 FR 8800, Mar. 3, 1978]

§ 101-25.113 [Reserved]

§ 101-25.114 Supply management surveys and assistance.

Under the provisions of 40 U.S.C. 487, the General Services Administration will perform surveys and/or reviews of Government property and property management practices of executive agencies. These surveys or reviews will be conducted by the Federal Supply Service in connection with regular surveys and studies of agency supply management practices or when providing assistance in the development of agency property accounting systems. Written reports of findings and recommendations will be provided to agency heads.

[45 FR 41947, June 23, 1980]

Subpart 101-25.2—Interagency Purchase Assignments

SOURCE: 29 FR 15991, Dec. 1, 1964, unless otherwise noted.

§ 101-25.201 General.

(a) This subpart prescribes the basic policy for interagency purchase assignments within the executive branch of the Government. It is directly applicable to executive agencies and concerns other Federal agencies in their purchasing from, through, or under contracts made by executive agencies.

(b) The term *purchase assignment* as used in this subpart shall normally be considered to include performance of the following functions:

(1) Arranging with requiring agencies for phased submission of requirements and procurement requisitions.

(2) Soliciting and analyzing bids and negotiating, awarding, and executing contracts.

(3) General contract administration.

(4) Arranging for inspection and delivery.

(5) Promotion of a maximum practicable degree of standardization in specifications and establishment of Federal Specifications, when possible, in accordance with applicable regulations.

(c) Notice of purchase assignments and applicable delegations of authority, made under the provisions of this subpart 101-25.2, shall be furnished to the General Accounting Office by GSA.

§ 101-25.202 Factors to be used to determine assignment of purchase responsibility.

With their consent or upon direction of the President, executive agencies will be designated and authorized by the Administrator of General Services exclusively, or with specified limited exceptions, to make purchases and contracts on a continuing basis for items or item groups of articles and services for the executive branch of the Government, after due consideration of the following factors, weighted as appropriate:

(a) Current or potential predominant use or consumption by a given agency.

(b) Availability of funds to carry out the assignment on a Government-wide basis or with limited exceptions.

(c) Specialized personnel, or the nucleus of such personnel, regularly employed by the agency, such as scientific, research, and operating technicians, especially qualified or experienced in specification writing, buying, inspecting, testing, using, installing, or operating a particular item or group of items.

(d) Custodianship and operation of special facilities such as research and testing laboratories and inspection or testing stations and devices.

(e) Actual or potential qualifications and experience of agency purchasing and contracting officials and their operating units with due regard to adequacy of staff.

(f) Past experience of the agency in performing services to other agencies on an informal or joint cooperative basis.

(g) Relations of the agency with the industry involved.

(h) Physical proximity of the agency purchasing office or offices to the requirement-compiling elements of the principal using agencies.

(i) Physical location of the agency purchasing office or offices in relation to market areas.

(j) Physical proximity of the agency purchasing offices in relation to engineering or design offices, in the interest of speed in processing modifications in design and specifications, and also reviewing bids for specifications compliance.

(k) Relative interest of agency heads in receiving the purchase assignment and specific requests of agency heads to do the buying of a given item or group of items on a Government-wide basis.

§ 101-25.203 Centralized purchases by GSA.

GSA will exclusively, or with specified limited exceptions, make purchases and contracts on a continuing basis for articles and services for the executive branch of the Government in the interest of lower prices, improved quality, and service or standardization when:

(a) The item or item groups of articles and services are items of "common-use" which are defined as items of standard commercial production or items covered by Federal Specifications commonly used by both civilian and military activities, or by two or more civilian activities, and not requiring such substantial alterations to adapt them to military or other particular application as to render inclusion in a centralized purchasing program impracticable; or

(b) A number of agencies, representing the majority users according to dollar volume, request GSA to make purchases and contracts exclusively for a given item or item groups of articles and services even though not "common-use" items as defined in §101-25.203(a); and

(c) GSA is best equipped to do the buying based upon the factors listed in §101-25.202, or must of necessity act as the central purchasing office when other agencies more appropriately suited to make central purchases do not do so and are not so directed by the President; and

(d) The head of another executive agency has not been delegated authority by the Administrator of General Services exclusively, or with specified limited exceptions, to make purchases and contracts for prescribed items or item groups of articles and services for the executive branch of the Government in accordance with §§101-25.202 and 101-25.204.

(e) GSA has issued appropriate regulations, or a Federal Supply Schedule, specifically designating the item or item groups of articles or services that fall within paragraphs (a), (b), and (c) of this §101-25.203 that are thereafter to be purchased exclusively for all executive agencies, or with specified limited exceptions, by GSA.

§101-25.204 Centralized purchases by designated executive agencies under authority delegated by the Administrator of General Services.

Designated executive agencies will exclusively, or with specified limited exceptions, make purchases and contracts on a continuing basis for items or item groups of articles and services for the executive branch of the Govern-

ment in the interest of lower prices, improved quality, and service or standardization when:

(a) The Administrator of General Services has determined, based upon the factors listed in §101-25.202, that a selected executive agency is best equipped to perform certain purchasing and contracting functions, and the Administrator of General Services has issued appropriate regulations designating the categories of articles or services complying with paragraphs (a), (b), and (c) of §101-25.203 that are to be purchased exclusively by the named executive agency under authority delegated by the Administrator of General Services; and

(b) The head of the designated executive agency has issued appropriate instructions, or a Federal Supply Schedule, under authority as delegated by and in the form approved by the Administrator, specifically designating the item or item groups of articles or services that are thereafter to be purchased exclusively for all executive agencies, or with specified limited exceptions, by the designated executive agency.

§ 101-25.205 Arrangement for performance of purchasing functions other than centralized.

(a) Upon request, GSA will make purchases and contracts for any of the items or item groups of articles or services authorized to be purchased independently by executive agencies. GSA will also arrange, on a basis mutually agreeable, with any executive agency to perform its purchase and contracting functions on a continuing basis, if requested in writing to do so by the agency head, provided the arrangements agreed upon will result in lowered cost or improved service either to the individual agency or to the Government as a whole.

(b) In those instances where lowered cost or improved service, either to an individual agency or to the Government as a whole will result, GSA will arrange, on a basis mutually agreeable to the agencies involved, to assign all or a portion of the purchase and contracting functions of one executive agency to another executive agency on a continuing basis.

§ 101-25.206

§ 101-25.206 Independent purchases by executive agencies.

Items or groups of items of articles or services may be purchased independently by executive agencies, in accordance with regulations of GSA otherwise applicable, when:

(a) Not otherwise prescribed in current regulations, or included in mandatory Federal Supply Schedules, issued by GSA or by another executive agency designated by the Administrator of General Services.

(b) For emergency requirements when time does not permit purchasing through the authorized central purchasing agency. A record shall be maintained of such transactions and be made available to the responsible central purchasing agency upon request.

(c) By consultation between GSA and agencies concerned, it is determined that interagency purchase assignment would adversely affect the national security or military operations.

(d) The purchases cannot be publicly disclosed in the interest of national security.

Subpart 101-25.3—Use Standards

§ 101-25.301 General.

(a) This subpart prescribes minimum use standards for certain Government-owned personal property which shall be applied by all executive agencies. Additional criteria above these minimum standards shall be established by each executive agency, limiting its property to the minimum requirements necessary for the efficient functioning of the particular office concerned. This subpart does not apply to automatic data processing equipment (ADPE) which is covered in the Federal Information Resources Management Regulation (FIRMR) (41 CFR Chapter 201).

(b) Additional use standards should be established by all executive agencies for other Government-owned property under their control whenever use standards will effect economy and efficiency in the use of such property.

(c) All items of property, determined to be excess to the needs of an agency as a result of the application of use

41 CFR Ch. 101 (7-1-01 Edition)

standards, shall be promptly reported in accordance with part 101-43.

[29 FR 15993, Dec. 1, 1964, as amended at 61 FR 14978, Apr. 4, 1996]

§ 101-25.302 Office furniture, furnishings, and equipment.

(a) Each executive agency shall establish criteria for the use of office furniture, furnishings, and equipment. Such criteria shall be in consonance with the provisions of § 101-25.104 pertaining to office furniture and office machines and shall be limited to the minimum essential requirements as established by the agency head for authorized functions and programs which will, beyond a reasonable doubt, be in operation within the following 6 months.

(b) In developing such criteria, a distinction shall be made between the requirements of organizational elements concerned with purely administrative functions, and those of a technical, scientific, or specialized nature.

(c) Items of office equipment, used only occasionally, should be pooled within an agency and made available to activities of the agency when and as necessary.

[29 FR 15993, Dec. 1, 1964, as amended at 42 FR 1031, Jan. 5, 1977]

§ 101-25.302-1 [Reserved]

§ 101-25.302-2 Filing cabinets.

Executive agencies shall make every effort to effect maximum use of filing cabinets and to limit the purchase of new equipment. Filing cabinets should be replaced only in accordance with the standards in subpart 101-25.4. Maximum utilization of equipment should be obtained by:

(a) Disposing of all records that have been authorized for disposition by the Congress or, where such authorization has not been obtained, through the preparation and obtaining of authorized disposal schedules with the assistance of the National Archives and Records Administration.

(b) Removing office supplies, publications, and other nonrecord material from filing cabinets to more suitable storage equipment, except where the quantity of such material is small (as a rule, less than half a cabinet).

Federal Property Management Regulations

§ 101-25.404

(c) Transferring to Federal Records Centers or approved agency records centers (to the extent that facilities are made available) inactive records not needed in daily business but not yet ready for disposal, when filing equipment can be released by such action.

(d) Shifting less active files, not transferable to approved records centers, to fiberboard storage boxes, using filing cabinets only when files are constantly used.

(e) Using filing cabinets with locks only when required by special needs that cannot be satisfied less expensively.

(f) Using letter-size filing cabinets instead of legal-size whenever possible.

(g) Using 5-drawer filing cabinets whenever available in lieu of 4-drawer cabinets.

[29 FR 15993, Dec. 1, 1964, as amended at 53 FR 11848, Apr. 11, 1988; 61 FR 14978, Apr. 4, 1996]

§§ 101-25.302-3—101-25.302-4 [Reserved]

§ 101-25.302-5 Carpeting.

(a) Carpeting is authorized for use where it can be justified over other types of floor covering on the basis of cost, safety, insulation, acoustical control, the degree of interior decoration required, or the need to maintain an environment commensurate with the purpose for which the space is allocated.

(b) In connection with new construction or alteration of space, if it is known that the area will eventually require carpeting, then resilient floor covering should be omitted and the carpeting installed initially.

[43 FR 18673, May 2, 1978, as amended at 49 FR 48546, Dec. 13, 1984]

§ 101-25.302-6 [Reserved]

§ 101-25.302-7 Draperies.

Draperies are authorized for use where justified over other types of window coverings on the basis of cost, insulation, acoustical control, or maintenance of an environment commensurate with the purpose for which the space is allocated. Determining whether the use of draperies is justified is a

responsibility of the agency occupying the building or space involved after consultation with the agency operating or managing the building. Authorized draperies shall be of non-combustible or flame-resistant fabric as required in § 101-20.105-1.

[61 FR 14978, Apr. 4, 1996]

Subpart 101-25.4—Replacement Standards

§ 101-25.401 General.

This subpart prescribes minimum replacement standards to be used by executive agencies desiring to replace specified types of items indicated in this subpart. Executive agencies shall retain items which are in usable workable condition even though the standard permits replacement, provided the item can continue to be used or operated without excessive maintenance cost or substantial reduction in trade-in value.

[29 FR 15994, Dec. 1, 1964]

§ 101-25.402 Motor vehicles.

Replacement of motor vehicles shall be in accordance with the standards prescribed in § 101-38.402.

[53 FR 11848, Apr. 11, 1988]

§ 101-25.403 [Reserved]

§ 101-25.404 Furniture.

Furniture (office, household and quarters, and institutional) shall not be replaced unless the estimated cost of repair or rehabilitation (based on GSA term contracts), including any transportation expense, exceeds at least 75 percent of the cost of a new item of the same type and class (based on prices as shown in the current edition of the GSA Supply Catalog, applicable Federal Supply Schedules, or the lowest available market price). An exception is authorized in those unusual situations in which rehabilitation of the furniture at 75 percent or less of the cost of a new item would not extend its useful life for a period compatible with the cost of rehabilitation as determined by the agency head or his designee.

[38 FR 28566, Oct. 15, 1973]

§ 101-25.404-1

41 CFR Ch. 101 (7-1-01 Edition)

§ 101-25.404-1 Limitation.

Notwithstanding the provisions in § 101-25.404, agencies shall limit acquisition of new office furniture to essential requirements as provided in § 101-25.104. Replacement of correspondence filing cabinets will be governed by the provisions of § 101-26.308.

[61 FR 14978, Apr. 4, 1996]

§ 101-25.405 Materials handling equipment.

(a) Materials handling equipment will not be replaced unless the estimated cost of necessary one-time repair or reconditioning of each piece of equipment exceeds, at lowest available cost, the applicable percentage of acquisition cost as shown in column 3 of the following table. Equipment eligible for replacement under the criteria es-

tablished by this standard may be repaired provided the expected economical life is extended commensurate with the expenditure required. Prior to incurring repair costs for equipment eligible for replacement, consideration should be given to the continuing availability of repair parts.

(1) Years in use shall be determined in accordance with the following:

(i) An operating month is considered equal to 100 operating hours. For materials handling equipment in storage, one month in storage equals 50 hours of operation.

(ii) The number of years in use is determined by dividing the number of operating months by 12. The fractional years in use resulting from this computation will be rounded to the nearest full year.

Column 1—Type of unit	Column 2—Expected years of economical use	Column 3—Maximum allowable "one-time repair limits" as percentage of acquisition costs (years in use)														
		1	2	3	4	5	6	7	8	9	10	11	12	13	14	15
GASOLINE																
Fork truck (2000 pounds to 6000 pounds)	8	50	45	40	30	25	20	15	10
Fork truck (over 6000 pounds)	10	50	45	40	35	30	25	20	15	10	10
Tractor	8	50	45	40	30	25	20	15	10
Crane	12	50	50	45	45	40	40	35	30	25	20	15	10
Platform truck	8	50	45	40	30	25	20	15	10
Straddle truck	15	50	50	50	45	45	45	40	40	35	35	30	25	20	15	10
ELECTRIC																
Fork truck (2000 pounds to 6000 pounds)	15	50	50	50	45	45	45	40	40	35	35	30	25	20	15	10
Tractor	15	50	50	50	45	45	45	40	40	35	35	30	25	20	15	10
Crane	15	50	50	50	45	45	45	40	40	35	35	30	25	20	15	10
Platform truck	15	50	50	50	45	45	45	40	40	35	35	30	25	20	15	10
Pallet truck	15	50	50	50	45	45	45	40	40	35	35	30	25	20	15	10

(2) In using the maximum allowable one-time repair limits in column 3 of the table, costs such as parts, labor, and transportation incident to the repairs, are to be included in computing one-time repair costs. However, operating expenses such as fuels and lubricants, replacement tires and batteries, and antifreeze will not be included in the one-time repair cost estimate.

(b) Notwithstanding the limitations prescribed in § 101-25.405(a), materials handling equipment may be replaced under the following conditions provided a written justification supporting such replacement is approved by the agency head or an authorized designee.

The justification shall be retained in the agency files.

(1) When the cumulative repair costs on a piece of equipment appears to be excessive as indicated by repair records. However, because an item of equipment accrues repair costs equal to the acquisition cost, it is not necessarily indicative of the current condition of the equipment. For example, a substantial repair expenditure included in the cumulative cost may actually have resulted in restoring the equipment to as good as new condition. While cumulative repair costs suggest an area for investigation, they should not be used as the principal ingredient

Federal Property Management Regulations

Pt. 101-26

in the repair/replacement decision making process.

(2) When repair parts are not available causing excessive equipment out-of-service time.

(3) When the equipment lacks essential features required in a particular task which is of a continuing nature and other suitable equipment is not readily available.

[32 FR 12400, Aug. 25, 1967]

Subpart 101-25.5—Purchase or Lease Determinations

§101-25.500 Cross-reference to the Federal Acquisition Regulation (FAR) (48 CFR chapter 1, parts 1-99).

For guidance see Federal Acquisition Regulation Subpart 7.4 (48 CFR Subpart 7.4).

[64 FR 34734, June 29, 1999]

Subparts 101-25.6—101-25.49 [Reserved]

PART 101-26—PROCUREMENT SOURCES AND PROGRAM

Sec.

101-26.000 Scope of part.

Subpart 101-26.1—General

101-26.100 Scope of subpart.
101-26.100-1 Procurement of lowest cost items.
101-26.100-2 Request for waivers.
101-26.100-3 Warranties.
101-26.101 Utilization of long supply and excess personal property.
101-26.102 Special buying services.
101-26.102-1 General.
101-26.102-2 Utilization by military agencies.
101-26.102-3 Procurement leadtime.
101-26.102-4 Payment to GSA contractors.
101-26.103 Establishing essentiality of requirements.
101-26.103-1 Policy for personal property.
101-26.103-2 Restriction on personal convenience items.
101-26.104 End-of-year submission of requisitions for action by GSA.
101-26.105 Justification to support negotiated procurement by GSA for other agencies.
101-26.106 Consolidation of requirements.
101-26.107 Priorities for use of supply sources.

Subpart 101-26.2—Federal Requisitioning System

101-26.200 Scope of subpart.
101-26.201 General.
101-26.202 Applicability.
101-26.203 Activity address codes.
101-26.204—101-26.205 [Reserved]
101-26.206 GSA assistance.

Subpart 101-26.3—Procurement of GSA Stock Items

101-26.300 Scope of subpart.
101-26.301 Applicability.
101-26.301-1 Similar items.
101-26.301-2 Issue of used, repaired, and rehabilitated items in serviceable condition.
101-26.302 Standard and optional forms.
101-26.303 Out-of-stock items.
101-26.304 Substitution policy.
101-26.305 Submission of orders to GSA.
101-26.306 Planned requisitioning for GSA stock items.
101-26.307 Processing overages, shortages, and damages.
101-26.308 Obtaining filing cabinets.
101-26.309 Cancellation of orders for GSA stock items.
101-26.310 Ordering errors.
101-26.311 Frustrated shipments.

Subpart 101-26.4—Federal Supply Schedules [Reserved]

Subpart 101-26.5—GSA Procurement Programs

101-26.500 Scope and applicability of subpart.
101-26.501 Purchase of new motor vehicles.
101-26.501-1 General.
101-26.501-2 Standardized buying programs.
101-26.501-3 Consolidated purchase program.
101-26.501-4 Submission of orders.
101-26.501-5 Procurement time schedules.
101-26.501-6 Forms used in connection with delivery of vehicles.
101-26.501-7 Sale of vehicles.
101-26.501-8 [Reserved]
101-26.501-9 Centralized motor vehicle leasing program.
101-26.502 U.S. Government National Credit Card.
101-26.503 Multiple award schedule purchases made by GSA supply distribution facilities.
101-26.504 [Reserved]
101-26.505 Office and household furniture and furnishings.
101-26.505-1 Description of office and household furniture.
101-26.505-2 Description of office and household furnishings.

Pt. 101-26

41 CFR Ch. 101 (7-1-01 Edition)

- 101-26.505-3 Requests to procure similar items from sources other than GSA supply sources.
- 101-26.505-4—101-26.505-6 [Reserved]
- 101-26.505-7 GSA assistance in selection of furniture and furnishings.
- 101-26.506 Interior planning and design services.
- 101-26.506-1 Types of service.
- 101-26.506-2 Limitations.
- 101-26.506-3 Submission of requests.
- 101-26.506-4 Acceptance and processing of requests.
- 101-26.506-5 Reimbursement for services.
- 101-26.507 Security equipment.
- 101-26.507-1 Submission of requisitions.
- 101-26.507-2 Procurement time schedule.
- 101-26.507-3 Purchase of security equipment from Federal Supply Schedules.
- 101-26.507-4 Quantities in excess of the maximum order limitation.
- 101-26.508 Electronic data processing (EDP) tape and instrumentation tape (wide and intermediate band).
- 101-26.508-1 Requisitioning data processing tape available through Federal Supply Schedule contracts.
- 101-26.508-2 Requisitioning data processing tape not available from Federal Supply Schedule contracts.
- 101-26.508-3 Consolidation of requisitions.
- 101-26.509 Tabulating machine cards.
- 101-26.509-1 Requisitioning tabulating machine cards available from Federal Supply Schedule contracts.
- 101-26.509-2 Requisitioning tabulating machine cards not available from Federal Supply Schedule contracts.
- 101-26.509-3 Consolidation of requisitions.

Subpart 101-26.6—Procurement Sources Other Than GSA

- 101-26.600 Scope and applicability of subpart.
- 101-26.601 [Reserved]
- 101-26.602 Fuels and packaged petroleum products obtained from or through the Defense Logistics Agency.
- 101-26.602-1 Procurement of lubricating oils, greases, and gear lubricants.
- 101-26.602-2 Procurement of packaged petroleum products.
- 101-26.602-3 Procurement of gasoline, fuel oil (diesel and burner), kerosene, and solvents.
- 101-26.602-4 Procurement of coal.
- 101-26.602-5 Procurement of natural gas from the wellhead and other supply sources.
- 101-26.603 Electronic items available from the Defense Logistics Agency.
- 101-26.605 Items other than petroleum products and electronic items available from the Defense Logistics Agency.

- 101-26.606 Supply support available from the inventory control points of the military departments.
- 101-26.607 Billings.
- 101-26.607-1 Payments.
- 101-26.607-2 Adjustments.
- 101-26.607-3 Emergency requirements.

Subpart 101-26.7—Procurement Sources Other Than GSA and the Department of Defense

- 101-26.700 Scope and applicability of subpart.
- 101-26.701 Purchase of products and services from the blind and other severely handicapped persons.
- 101-26.702 Purchase of products manufactured by the Federal Prison Industries, Inc.
- 101-26.703 Marginally punched continuous forms.
- 101-26.704 Purchase of nonperishable subsistence (NPS) items.

Subpart 101-26.8—Discrepancies or Deficiencies in GSA or DOD Shipments, Material, or Billings

- 101-26.800 Scope of subpart.
- 101-26.801 Applicability.
- 101-26.802 Exclusions.
- 101-26.803 Discrepancies or deficiencies in shipments, material, or billings.
- 101-26.803-1 Reporting discrepancies or deficiencies.
- 101-26.803-2 Reporting quality deficiencies.
- 101-26.803-3 Reporting of discrepancies in transportation, shipments, material, or billings.
- 101-26.803-4 Adjustments.

Subparts 101-26.9—101-26.48 [Reserved]

Subpart 101-26.49—Illustrations of Forms

- 101-26.4900 Scope of subpart.
- 101-26.4901 Standard forms.
- 101-26.4901-149 Standard Form 149, U.S. Government National Credit Card.
- 101-26.4902 GSA forms.
- 101-26.4902-457 GSA Form 457, FSS Publications Mailing List Application.
- 101-26.4902-1398 GSA Form 1398: Motor vehicle purchase and inspection label.
- 101-26.4902-1424 GSA Form 1424, GSA Supplemental Provisions.
- 101-26.4902-1781 GSA Form 1781, Motor Vehicle Requisition—Delivery Order.
- 101-26.4902-2891 GSA Form 2891, Instructions to Users of Federal Supply Schedules.
- 101-26.4904 Other agency forms.
- 101-26.4904-416 DD Form 416: Purchase Request for Coal, Coke, or Briquettes.

AUTHORITY: Sec. 205(c), 63 Stat. 390; 40 U.S.C. 486(c).

Federal Property Management Regulations

§ 101-26.100-2

§ 101-26.000 Scope of part.

This part prescribes policies and procedures which govern the procurement of personal property and nonpersonal services by Federal agencies from or through GSA supply sources as established by law or other competent authority. The specific subparts or sections covering the subject matter involved prescribe the extent to which the sources of supply are to be used by Government agencies. Certain civilian and military commissaries and non-appropriated fund activities are also eligible to use GSA supply sources for their own use, not for resale, unless otherwise authorized by the individual Federal agency and concurred in by GSA. Policy and procedures pertaining to purchasing of property or contracting for services from commercial sources, without recourse to established GSA supply sources, are provided in the Federal Acquisition Regulation (FAR) (48 CFR chapter 1).

[56 FR 12455, Mar. 26, 1991]

Subpart 101-26.1—General

§ 101-26.100 Scope of subpart.

This subpart provides policy guidance of a general nature concerning procurement of lowest cost items obtainable from GSA supply sources; availability from GSA of special buying services in addition to the specified GSA procurement sources; criteria for placing end-of-year purchase documents with GSA and for insuring that end-of-year requisitions placed with GSA obligate the applicable fiscal year appropriation; and justification requirements to support negotiated procurement by GSA for other agencies.

[36 FR 17423, Aug. 31, 1971]

§ 101-26.100-1 Procurement of lowest cost items.

GSA provides lines of similar items to meet particular end-use requirements under the GSA stock program, special order program (SOP) established source, and the Federal Supply Schedule program. Although these similar items may differ in terms of price, quality, and essential characteristics, they often can serve the same functional end-use procurement needs

of the various ordering agencies. Therefore, in submitting requisitions or placing delivery orders for similar items obtainable from GSA sources, agencies shall utilize the source from which the lowest cost item can be obtained which will adequately serve the functional end-use purpose.

[56 FR 12455, Mar. 26, 1991]

§ 101-26.100-2 Request for waivers.

Waiver requests, when required by § 101-26.102-1 (special order program established source items), § 101-26.301 (GSA stock items) or § 101-26.401-3(b) (Federal Supply Schedule items), shall be submitted to the Commissioner, Federal Supply Service (F), General Services Administration, Washington, DC 20406. Waiver requests will be approved if considered justified. Approval of a waiver request does not constitute authority for a sole source procurement. Depending on the basis for the waiver request, each request shall contain the following information:

(a) Waiver requests based on determination that the GSA item is not of the requisite quality or will not serve the required functional end-use purpose of the agency requesting the waiver shall include the following information with each request:

(1) A complete description of the type of item needed to satisfy the requirement. Descriptive literature such as cuts, illustrations, drawings, and brochures which show the characteristics or construction of the type of item or an explanation of the operation should be furnished whenever possible.

(2) The item description and the stock number (NSN if possible) of the GSA item being compared. Inadequacies of the GSA items in performing the required functions.

(3) The quantity required. (If demand is recurrent, nonrecurrent, or unpredictable, so state.)

(4) The name and telephone number of the person to be contacted when questions arise concerning the request.

(5) Other pertinent data, when applicable.

(b) Waiver request based on determination that the GSA item can be purchased locally at a lower price shall include the following information with each request. However, the price alone

§ 101-26.100-3

41 CFR Ch. 101 (7-1-01 Edition)

of an item without other substantive consideration will not be considered sufficient justification to approve a waiver request.

(1) A complete description of the type of item needed to satisfy the requirement.

(2) The quantity required. (If demand is recurrent, nonrecurrent, or unpredictable, so state.)

(3) The destination of item to be delivered.

(4) The name and address of source.

(5) A price comparison with the GSA item, including the NSN of the GSA item. Cost comparisons shall include the agency administrative cost to effect the local purchase.

(6) The name and telephone number of the person to be contacted when questions arise concerning the request.

(7) Other pertinent data, when applicable.

(c) When the item is a Standard or optional form available from GSA stock, the provisions of §101-26.302 apply.

(d) Agencies shall not initiate action to procure similar items from non-GSA sources until a request for a waiver has been requested from and approved by GSA. The fact that action to procure a similar item has been initiated will not influence GSA action on a request for waiver.

(e) Waivers are not required for items or services procured in accordance with the policy set forth in §101-26.100-1 relating to the acquisition of the lowest cost item from GSA sources, §101-26.401-4(f) relating to the purchase of products that are available at prices lower than the prices of identical products provided by multiple award Federal Supply Schedule contracts, or when an urgent requirement exists in accordance with FAR 6.302-2 (48 CFR 6.302-2).

[56 FR 12455, Mar. 26, 1991]

§ 101-26.100-3 Warranties.

Through its procurement sources and programs GSA provides for certain types of items and services which are covered by warranties. Such warranties allow ordering activities additional time after acceptance within which to assert a right to correct certain deficiencies in supplies or services fur-

nished. The additional time period and the specific corrective actions for which the contractor is responsible are usually stated in the warranty. Items and services subject to warranties are normally identified by a warranty marking or notice. Such marking or notice will state that a warranty exists, its extent of coverage, its duration, and whom to notify concerning defects. Using activities shall take the following actions when items or services (except for automotive vehicles and components which are subject to the provisions of §101-26.501-6) covered by warranty provisions are found to be defective during the warranty period.

(a) Activities shall attempt to resolve all complaints where a warranty is involved. If the contractor replaces the item or corrects the deficiency, a Standard Form (SF) 368, Product Quality Deficiency Report, in duplicate, shall be sent to the GSA Discrepancy Reports Center (6FR), 1500 East Bannister Road, Kansas City, MO 64131-3088. The resolution of the case should be clearly stated in the text of the SF 368. This information will be maintained as a quality history file for use in future procurements.

(b) If the contractor refuses to correct, or fails to replace, a defective item or an aspect of service under the warranty, an SF 368, in duplicate, along with copies of all pertinent correspondence, shall be submitted to the contracting officer in the appropriate GSA commodity center for necessary action. The address of the contracting officer is contained in the contract/purchase order, except for schedule items where the address is shown in the Federal Supply Schedule.

[56 FR 12456, Mar. 26, 1991]

§ 101-26.101 Utilization of long supply and excess personal property.

To the fullest extent practicable, agencies shall utilize inventories in long supply, as prescribed in subpart 101-27.3, and excess personal property, as prescribed in part 101-43, as a first source of supply in fulfilling their requirements.

[34 FR 200, Jan. 7, 1969]

Federal Property Management Regulations

§ 101-26.103-1

§ 101-26.102 Special buying services.

§ 101-26.102-1 General.

The special buying services of GSA are performed through the GSA special order program (SOP). The SOP allows an agency to obtain items not included in either the GSA stock or Federal Supply Schedule program. All executive agencies within the United States (including Hawaii and Alaska), in order to maximize the use of the Government's centralized supply system, shall request SOP items by submitting requisitions for GSA centrally managed items to GSA. GSA will process all requisitions for SOP items, regardless of total line item value, from activities electing to purchase from GSA. If an agency determines that alternative sources are more favorable, procurement from other sources is authorized: Provided, that the dollar thresholds and criteria outlined in § 101-26.301(b)(1) through (3) are followed.

[56 FR 12456, Mar. 26, 1991]

§ 101-26.102-2 Utilization by military agencies.

Military activities shall utilize the buying services of GSA when:

(a) GSA has agreed with the Secretary of Defense, or with the Secretary of a military department in connection with the requirements of that department, to perform such buying services; and

(b) The items involved are not properly obtainable from GSA stock or Federal Supply Schedules.

[29 FR 15610, Nov. 20, 1964, as amended at 36 FR 17423, Aug. 31, 1971]

§ 101-26.102-3 Procurement leadtime.

When GSA performs the purchasing services for other agencies or activities as contemplated by this § 101-26.102-3, calculation of the delivery dates required for the items involved must be based on the procurement leadtimes illustrated in the GSA publication, FEDSTRIP Operating Guide. These leadtimes are based on the normal time required after receipt of agency requisitions by GSA to effect delivery to destinations within the 50 States.

(a) Time required to obtain any additional essential information from the

requisitioning office for use in issuing a solicitation for bids or offers is not included in the leadtimes.

(b) If unusually large quantities or complex items are required, leadtime adjustments should be made to reflect the specific requirement. As an example, standard furniture items can usually be delivered in less than 90 days after receipt of the requisition. However, for large quantity or complex orders requiring a definite quantity procurement, delivery times may range from 4 to 6 months. Footnotes relating to classes where this is a frequent occurrence are shown in the procurement leadtime table illustrated in the FEDSTRIP Operating Guide.

(c) The procurement leadtime table illustrated in the FEDSTRIP Operating Guide does not apply to public exigency or other high priority requisitions; however, it should be used as a guide to establish realistic required delivery dates for such requisitions.

[32 FR 17939, Dec. 15, 1967, as amended at 40 FR 41093, Sept. 5, 1975; 57 FR 3949, Feb. 3, 1992]

§ 101-26.102-4 Payment to GSA contractors.

Policies and procedures covering payment to GSA contractors for supplies and services furnished by GSA to Government agencies are in subpart 101-2.1.

[47 FR 8779, Mar. 2, 1982]

§ 101-26.103 Establishing essentiality of requirements.

§ 101-26.103-1 Policy for personal property.

To obtain maximum benefit from Government funds available for procurement of personal property, each executive agency shall:

(a) Insure that personal property currently on hand is being utilized to the fullest extent practical and provide supporting justification prior to effecting new procurement for similar type property. (When the proposed procurement is for similar items from non-GSA sources, the provisions of § 101-26.100-2 apply.)

(b) Procure the minimum quantity and quality of property which is required to support the mission of the

agency and to satisfy the function for which the property is required.

(c) Limit procurement of different varieties, types, sizes, colors, etc., of required items to those essential in satisfying the functional end-use purpose. To this end the quantity, quality, and variety of personal property required to adequately perform the end-use function should be determined prior to initiation of procurement processes.

[36 FR 17423, Aug. 31, 1971]

§ 101-26.103-2 Restriction on personal convenience items.

Government funds may be expended for pictures, objects of art, plants, or flowers (both artificial and real), or any other similar type items when such items are included in a plan for the decoration of Federal buildings approved by the agency responsible for the design and construction. Determinations as to the need for purchasing such items for use in space assigned to any agency are judgments reserved to the agency. Determinations with respect to public space such as corridors and lobbies are reserved to the agency responsible for operation of the building. Except as otherwise authorized by law, Government funds shall not be expended for pictures, objects of art, plants, flowers (both artificial and real), or any other similar type items intended solely for the personal convenience or to satisfy the personal desire of an official or employee. These items fall into the category of "luxury items" since they do not contribute to the fulfillment of missions normally assigned to Federal agencies.

[36 FR 17423, Aug. 31, 1971]

§ 101-26.104 End-of-year submission of requisitions for action by GSA.

(a) Purchase documents for supplies or services submitted to GSA at or near the close of a fiscal year shall reflect actual agency requirements and shall not be used as a means of exhausting appropriation balances.

(b) Under the FEDSTRIP/MILSTRIP systems, the requisitions submitted to GSA are not required to reflect the applicable appropriation or fiscal year funds to be charged. The fund code

entry on the requisition simply indicates to the supply source (GSA) that funds are available to pay the charge, thereby providing authority for the release of material and subsequent billing. Requisitions received by GSA in purchase authority format are normally converted to FEDSTRIP/MILSTRIP documentation so that processing can be accomplished expeditiously through a uniform system based on the use of automated equipment. Accordingly, primary responsibility rests with the ordering activity for ensuring that requisitions intended to be chargeable to appropriations expiring the last day of the fiscal year are submitted in sufficient time for GSA to consummate the necessary action before the end of the fiscal year. Requisitions submitted on or before the last day of the fiscal year may be chargeable to appropriations expiring on that date provided the ordering agency is required by law or GSA regulation to use GSA supply sources. When the ordering agency is not required to use GSA sources, requisitions for GSA stock items may be recorded as obligations provided the items are intended to meet a bona fide need of the fiscal year in which the need arises or to replace stock used in that fiscal year; requests for other than GSA stock items are to be recorded as obligations at the time GSA awards a contract for the required items. In the latter case, GSA procurement leadtimes illustrated in the GSA publication, FEDSTRIP Operating Guide, should be used as a guide for timely submission of these requisitions. The leadtimes referred to relate to the number of days between submission of a requisition and actual delivery of the items involved. While this may furnish some guidance to requisitioners, there is no direct relationship between those leadtimes and the time it takes for GSA to make an award of a contract.

(c) End-of-year submission of requisitions which require GSA to award a contract not later than the last day of the fiscal year in order to obligate the appropriation or funds of the ordering agency will be annotated to indicate that GSA procurement of the requested items must be accomplished not later than the last day of the fiscal year in

Federal Property Management Regulations

§ 101-26.107

which the requisitions are submitted. For example, a FEDSTRIP/MILSTRIP requisition should be prepared to include Document Identifier Code A0E or A05 and reflect the annotation in the "Remarks" block. With this information GSA will attempt to complete procurement action before the end of the fiscal year. When a requisition is received too late to permit GSA to complete procurement action before the end of the fiscal year, the requisitioning activity will be so notified and requested to furnish instructions regarding the action to be taken. Based on these instructions, procurement action will be taken or the requisition will be canceled and returned to the ordering activity.

[33 FR 19013, Dec. 20, 1968, as amended at 40 FR 41093, Sept. 5, 1975; 57 FR 3949, Feb. 3, 1992]

§ 101-26.105 Justification to support negotiated procurement by GSA for other agencies.

When a requisition submitted by an agency to GSA requires procurement without providing for full and open competition, the agency submitting the requisition will be so notified and required to furnish specific information to assist GSA in preparing the required written justification. The GSA contracting officer will defer procurement action pending receipt of the requested information. If the requisitioning agency has prior knowledge that a requisition will require procurement without providing for full and open competition (e.g., sole source acquisition), sufficient information shall be included with the requisition to allow GSA to justify the procurement. Specifically, the information must include the following:

(a) The specific needs to be satisfied in terms of identified tasks or work processes;

(b) The requirements that generate the specific needs;

(c) The characteristics of the designated item that enable it to satisfy the specific needs, if a specific source(s) is requested;

(d) The identification of other items evaluated and, for each, a statement of the characteristics (or lack thereof) which preclude their satisfying the spe-

cific needs, if a specific source(s) is requested;

(e) The citation of the applicable law, if any, authorizing other than full and open competition (see FAR 6.302 (48 CFR 6.302); and

(f) Any required certifications, pursuant to FAR 6.303-2(b) (48 CFR 6.303-2(b)), that supporting data is complete and accurate.

[56 FR 12456, Mar. 26, 1991]

§ 101-26.106 Consolidation of requirements.

Full consideration shall be given to the consolidation of individual small volume requirements to enable the Government to benefit from lower prices normally obtainable through definite quantity contracts for larger volume procurements. This policy pertains to procurement from commercial sources either directly or through an intermediary agency and does not apply to GSA stock items or small volume requirements normally obtained from GSA customer supply centers. When it is practical, each agency shall establish procedures that will permit planned requirements consolidation on an agencywide basis. When it is impractical to plan requirements on an agencywide consolidated basis, the requirements consolidation effort may be limited to a bureau, to other agency segments, or to a program, if such limited consolidation will provide significant price advantages when procurement is effected on a volume basis. Requisitions for item requirements exceeding maximum order limitations in Federal Supply Schedule contracts shall be submitted to GSA in accordance with the applicable instructions in the respective schedules. Special buying services desired by agencies for procurement of other consolidated item requirements shall be requested from GSA in accordance with § 101-26.102.

[51 FR 13498, Apr. 21, 1986]

§ 101-26.107 Priorities for use of supply sources.

(a) Executive agencies shall satisfy requirements for supplies and services

§ 101-26.200

from or through the sources and publications listed below in descending order of priority:

- (1) *Supplies.* (i) Agency inventories;
 - (ii) Excess for other agencies (see part 101-43 and 48 CFR subpart 8.1);
 - (iii) Federal Prison Industries, Inc. (UNICOR) (see §101-26.702 and 48 CFR subpart 8.6);
 - (iv) Procurement lists of products available from the Committee for Purchase From People Who Are Blind or Severely Disabled (see §101.26.701 and 48 CFR subpart 8.7);
 - (v) Central supply sources, such as the stock, special order, or customer supply center programs of the General Services Administration (GSA) (see subpart 101-26.3, §101-26.102, and subpart 101-28.3), the Defense Logistics Agency (see subpart 101-26.6), the Department of Veterans Affairs (see §101-26.704), and military inventory control points (see §101-26.606);
 - (vi) Mandatory Federal Supply Schedules (see subpart 101-26.4 and 48 CFR subpart 8.4);
 - (vii) Optional use Federal Supply Schedules (see subpart 101-26.4 and 48 CFR subpart 8.4); and
 - (viii) Commercial sources (including educational and nonprofit institutions).
- (2) *Services.* (i) Procurement lists of services available from the Committee for Purchase From People Who Are Blind or Severely Disabled (see §101-26.701 and 48 CFR subpart 8.7);
 - (ii) Mandatory Federal Supply Schedules (see subpart 101-26.4 and 48 CFR subpart 8.4);
 - (iii) Optional use Federal Supply Schedules (see subpart 101-26.4 and 48 CFR subpart 8.4); and
 - (iv) Federal Prison Industries, Inc. (UNICOR) (see §101-26.702 and 48 CFR subpart 8.6) or other commercial sources (including educational and nonprofit institutions).
- (b) Sources other than those listed in paragraph (a) of this section may be used as prescribed in §101-26.301 and in an unusual and compelling urgency as prescribed in §101-25.101-5 and 48 CFR 6.302-2.

[58 FR 41367, Aug. 5, 1993]

41 CFR Ch. 101 (7-1-01 Edition)

Subpart 101-26.2—Federal Requisitioning System

§ 101-26.200 Scope of subpart.

This subpart prescribes a uniform requisitioning and issue system for use in obtaining supplies and equipment from GSA, Department of Defense, and Veterans Administration sources.

[43 FR 19852, May 9, 1978]

§ 101-26.201 General.

This requisitioning and issue system is identified as the Federal Standard Requisitioning and Issue Procedures (FEDSTRIP) and is similar to and compatible with the Military Standard Requisitioning and Issue Procedures (MILSTRIP). The FEDSTRIP system provides GSA and other supply sources the means to automate the processing of requisitions. Detailed instructions required to implement FEDSTRIP are contained in the GSA Handbook, FEDSTRIP Operating Guide (FPMR 101-26.2), which is issued and maintained by the Commissioner, Federal Supply Service, GSA.

[43 FR 19852, May 9, 1978]

§ 101-26.202 Applicability.

The FEDSTRIP system shall be used by civilian agencies to requisition any item from GSA or to requisition any specifically authorized item from Department of Defense (DOD). Requisitions to the Veterans Administration (VA) should be submitted on punched cards in FEDSTRIP format or typed on Standard Form 147, Order for Supplies or Services.

[43 FR 19853, May 9, 1978]

§ 101-26.203 Activity address codes.

To obtain items through the FEDSTRIP system, each ordering activity is required to have an activity address code. The FEDSTRIP Operating Guide (FPMR 101-26.2) contains instructions to civilian agencies on requesting activity address codes. Once assigned, an activity address code allows an activity to order supplies under the FEDSTRIP system. Because there is a potential for abuse in the use of these codes, agencies shall establish stringent internal controls to ensure

Federal Property Management Regulations

§ 101-26.301

that the codes are used only by authorized personnel. It is imperative that all requests for activity address codes or deletions or address changes flow through a central contact point in the agency headquarters or regions where the need, purpose, and validity of the request can be verified. Agencies should send GSA the addresses of the contact points (mailing address: General Services Administration (FSR), Washington, DC 20406). GSA will only honor requests from the established points within the agency. GSA will periodically send a listing of current activity address codes and addresses to contact points for review.

[45 FR 71565, Oct. 29, 1980]

§§ 101-26.204—101-26.205 [Reserved]

§ 101-26.206 GSA assistance.

Agency field activities should direct their questions regarding FEDSTRIP to the Federal Supply Service at each GSA regional office. The addresses of GSA regional offices are listed in each of the volumes of the GSA Supply Catalog. Agency headquarters activities requiring assistance may contact General Services Administration (FSR), Washington, DC 20406.

[45 FR 71565, Oct. 29, 1980]

Subpart 101-26.3—Procurement of GSA Stock Items

§ 101-26.300 Scope of subpart.

This subpart prescribes policy and procedures governing the procurement by agencies of items of supply stocked by GSA, including reporting and obtaining adjustments for overages, shortages, and damages and the issue of used, repaired, and rehabilitated items in serviceable condition.

[35 FR 12721, Aug. 11, 1970]

§ 101-26.301 Applicability.

All executive agencies within the United States (including Hawaii and Alaska), in order to maximize the use of the Government's centralized supply system, shall requisition GSA stock items in accordance with the following:

(a) When the requirement is for Standard and optional forms, an item

produced by the Federal Prison Industries, Inc. (FPI), or an item listed in the procurement list published by the Committee for Purchase from the Blind and Other Severely Handicapped (NIB-NISH), the dollar thresholds and language indicated in paragraph (b) of this section are not applicable and acquisition of such items continues to be as set forth in the applicable sections of the Federal Acquisition Regulation, Federal Property Management Regulations and other appropriate regulations. In order to identify FPI/NIB-NISH items stocked by GSA, they are marked with an asterisk in the GSA Supply Catalog NSN index.

(b) GSA will process all requisitions for stock items, regardless of total line item value, from activities electing to purchase from GSA. If an agency determines that alternative sources are more favorable, the following guidelines shall apply. However, the price alone of an item without other substantive consideration will not be considered as sufficient justification to use alternative sources. (These guidelines also apply to the procurement of special order program (SOP) established source, see §101-26.102-1.)

(1) When the total value of the line item requirement is less than \$100, procurement from other sources is authorized.

(2) When the total value of the line item requirement is \$100 or more, but less than \$5,000, procurement from other sources is authorized: provided, that a written justification shall be prepared and placed in the purchase file stating that such action is judged to be in the best interest of the Government in terms of the combination of quality, timeliness, and cost that best meets the requirement. Cost comparisons shall include the agency administrative cost to effect a local purchase.

(3) For total line item requirements of \$5,000 and over, agencies shall submit a requisition to GSA unless a waiver has been approved by GSA. Request for waivers shall be submitted in accordance with §101-26.100-2.

(c) Agencies shall not divide requisitions to avoid higher threshold documentation requirements.

(d) In authorizing procurements in accordance with paragraph (b)(2) of

§ 101-26.301-1

41 CFR Ch. 101 (7-1-01 Edition)

this section, agencies shall reimburse GSA for any cost arising out of breach of a GSA contract, where sufficient justification is not documented in their procurement files.

[56 FR 12457, Mar. 26, 1991]

§ 101-26.301-1 Similar items.

(a) Agencies required to requisition, exclusively, items listed in the GSA Supply Catalog shall utilize such items in lieu of procuring similar items from other sources when the GSA items will adequately serve the required functional end-use purpose.

(b) When an agency determines that items available from GSA stock will not serve the required functional end-use purpose of the item proposed to be procured, a request to waive the requirement to use this source shall be submitted to GSA for consideration in accordance with the provisions of § 101-26.100-2.

[36 FR 17424, Aug. 31, 1971, as amended at 38 FR 28566, Oct. 15, 1973]

§ 101-26.301-2 Issue of used, repaired, and rehabilitated items in serviceable condition.

Stock items returned to GSA under the provisions of subpart 101-27.5 will be reissued to all requisitioning activities without distinction between new, used, repaired, or rehabilitated items in serviceable condition. Requisitioning agencies will be billed for these items at the current GSA selling price.

[38 FR 28566, Oct. 15, 1973]

§ 101-26.302 Standard and optional forms.

Agencies shall obtain Standard and optional forms by requisitioning them from GSA (FSS) unless the forms have been approved by GSA (KMPS) to be stocked and distributed by the promulgating agency or to be reproduced locally. Assistance or information on the forms management program may be obtained by contacting GSA (KMPS), Washington, DC 20405. (See part 201-45, subpart 201-45.5 of this chapter.)

(a) For purposes of economy, existing stocks are depleted prior to issuance of revisions unless the promulgating agency determines previous editions unusable and obsolete.

(b) Forms or form assemblies which deviate from the standard and optional forms listed in the GSA Supply Catalog have restricted use and are not stocked. Agencies requiring such forms shall prepare and transmit a Standard Form 1, Printing and Binding Requisition, or Standard Form 1-C, Printing and Binding Requisition for Specialty Items, to the General Services Administration, Federal Supply Service (FCNI), Washington, DC 20406, for review and submission to GPO. Prior approval of GSA (KMPS) is required whenever the content or construction of a form is altered or modified. Requests for such exceptions may be obtained by submission of a SF 152, Requests for Clearance of a Standard or Optional Form or Exception, to GSA (KMPS), with appropriate justification.

(c) Certain standard forms are serially numbered and are to be accounted for to prevent possible fraudulent use. The General Accounting Office (GAO) requires accurate accountability records to be maintained for such items by applicable agencies. GSA forwards a receipt verification card with each shipment of accountable forms. The receiving agency is responsible for verifying receipt of the serially numbered forms in the shipment by returning the card to the address preprinted on the card. See § 101-41.308 of this chapter for information governing agency control and disposition of unused U.S. Government Bills of Lading (GBL's).

(d) Standard and optional forms which are excess to the needs of an agency shall be reported to GSA in the same manner as other excess personal property pursuant to part 101-43 of this chapter. Obsolete forms shall be disposed of under the provisions of part 101-45 of this chapter.

[56 FR 12457, Mar. 26, 1991]

§ 101-26.303 Out-of-stock items.

Generally, it is more advantageous to agencies if GSA backorders requisitions for out-of-stock items rather than cancels requisitions. Unless notified by agencies not to backorder a requisition, through FEDSTRIP advice codes 2C or 2J, a back order will be established. The agency will be notified of the estimated date that shipment

Federal Property Management Regulations

§ 101-26.308

will be made. Upon receipt of the status transaction, the agency shall determine if the estimated shipping date will meet its needs and, as appropriate: (a) Accept the back order, (b) request a suitable substitute item, or (c) request cancellation in accordance with §101-26.309.

[43 FR 22210, May 24, 1978]

§ 101-26.304 Substitution policy.

In supplying items requisitioned from GSA stock, GSA may substitute items with similar characteristics. Substitute items may be issued from new stock or from returned stock that is in serviceable condition (condition code A) as described in §101-27.503-1. A notice of intent to substitute will be provided to the ordering activity only if the characteristics of the substitute item differ substantially from the characteristics of the item requisitioned. Ordering activities may prevent substitution by entering advice code 2B (do not substitute) or 2J (do not substitute or backorder) in cc 65-66 of requisitions.

[45 FR 27764, Apr. 24, 1980]

§ 101-26.305 Submission of orders to GSA.

(a) Orders shall be submitted in accordance with the instructions in the FEDSTRIP Operating Guide (FPMR 101-26.2).

(b) Orders in other than FEDSTRIP format shall be submitted:

(1) In original only when for shipment to destinations in the United States, including Hawaii but excluding Alaska.

(2) In accordance with applicable GSA/agency agreements when for shipment to Alaska or for export to destinations outside the United States.

(c) Sufficient funds should be reserved by the requisitioner to cover expenses incurred by GSA in export packing, marking, documentation, etc. GSA will assess a surcharge on all material ordered and delivered to customers in certain overseas areas. The surcharge is a percentage factor of the value of the material shipped. Information on the specific areas and the current percentage of surcharge is included in the GSA Handbook, Discrepancies or Defi-

ciencies in GSA or DOD Shipments, Material, or Billings (FPMR 101-26.8). The surcharge is a percentage factor of the value of the material shipped. Information on the current percentage of surcharge may be obtained from the GSA regional office to which orders are submitted.

[30 FR 13826, Oct. 30, 1965, as amended at 42 FR 58748, Nov. 11, 1977; 42 FR 61597, Dec. 6, 1977]

§ 101-26.306 Planned requisitioning for GSA stock items.

In preparing requisitions for GSA stock items, agencies shall follow schedules or cyclical plans for replenishment of stocks so as to reduce the number of repetitive requisitions required while adjusting ordering frequency to comply with the economic order quantity principle. (See §101-27.102.)

[43 FR 22211, May 24, 1978]

§ 101-26.307 Processing overages, shortages, and damages.

(a) Transportation-type discrepancies shall be processed in accordance with the instructions in subpart 101-40.7 when the discrepancies are the fault of the carrier and occur while the shipments are in the possession of:

(1) International ocean or air carriers, regardless of who pays the transportation charges, except when shipment is on a through Government bill of lading (TGBL) or is made through the Defense Transportation System (DTS) (Discrepancies in shipments on a TGBL or which occur while in the DTS shall be reported as prescribed in subpart 101-26.8.); or

(2) Carriers within the continental United States, when other than GSA or DOD pays the transportation charges.

(b) Reporting discrepancies or deficiencies in material or shipments and processing requests for or documenting adjustments in billings from or directed by GSA activities shall be in accordance with the provisions of subpart 101-26.8.

[41 FR 56320, Dec. 28, 1976]

§ 101-26.308 Obtaining filing cabinets.

Each agency head, after taking actions prescribed in §101-25.302-2, shall

§ 101-26.309

41 CFR Ch. 101 (7-1-01 Edition)

determine agency requirements for filing cabinets. When additional filing cabinets are required, requisitions shall be submitted in FEDSTRIP format to the GSA region supporting the geographic area in which the requisitioning agency is located.

[43 FR 22211, May 24, 1978]

§ 101-26.309 Cancellation of orders for GSA stock items.

When an agency determines that material ordered from GSA is not required, GSA will accept requests for cancellation as long as the items ordered have not been shipped. However, since processing cancellations is costly and interferes with normal order processing, agencies are cautioned to use discretion in requesting cancellation of low dollar value orders. Cancellation of orders may be accomplished by agencies through written, telegraphic, or telephonic communication with the GSA regional office to which the order was sent. However, telephonic communication should be used whenever feasible to forestall shipment of material and subsequent billing by GSA. If material has been shipped, GSA will advise that cancellation cannot be effected and agency requests for return for credit will be processed under the provisions of §§ 101-26.310 and 101-26.311.

[32 FR 11163, Aug. 1, 1967]

§ 101-26.310 Ordering errors.

In accordance with the provisions of this § 101-26.310, GSA may authorize agencies to return for credit material that has been ordered in error by the agency. Material shipped in error by GSA is subject to the provisions of the GSA Handbook, Discrepancies or Deficiencies in GSA or DOD Shipments, Material, or Billings (FPMR 101-26.8). Credit for material ordered in error will be based on the selling price billed the agency at the time shipment was made to the agency, with the adjustment reflected in current or future billings. Material shall not be returned until appropriate documentation is received from GSA.

(a) The return of material by an agency, to correct ordering errors, may be authorized and later accepted by GSA: *Provided*,

(1) The value of the material exceeds \$25 per line item based on the selling price billed the customer.

(2) Authorization to return is requested from the GSA Discrepancy Reports Center (6FRB), 1500 East Bannister Road, Kansas City, MO 64131 within 45 calendar days (60 calendar days for overseas points) after receipt of shipment. Requests should always contain a complete explanation of reason(s) for return of the material. Exceptions may be granted on a case-by-case basis when GSA is in need of the material and extenuating circumstances precluded earlier submission of the request.

(3) Each item is in "like-new" condition and is identified by a stock number in the current edition of the GSA Supply Catalog.

(4) Each item is identified with a specific purchase order or requisition number.

(5) The condition of the material is acceptable on inspection by GSA. When it is not acceptable, disposition, without credit, will be made by GSA. However, when the condition is attributable to carrier negligence, subsequent credit allowed by GSA will be reduced by the amount to be paid the agency by the carrier for damages incurred.

(6) The merchandise to be returned will not adversely affect the GSA nationwide inventory situation.

(7) The return transportation costs are not excessive in relation to the cost of the material.

(b) Transportation costs on material specifically authorized for return by a GSA regional office will be paid by the customer activity. Claims against carriers for discrepancies in shipment will also be the responsibility of the customer activity in accordance with the provisions of subpart 101-40.7. When appropriate, GSA will prepare initial documentation to support claim actions.

[35 FR 181, Jan. 6, 1970, as amended at 38 FR 28567, Oct. 15, 1973; 42 FR 58748, Nov. 11, 1977; 50 FR 42021, Oct. 17, 1985]

§ 101-26.311 Frustrated shipments.

(a) At the request of the ordering agency, GSA may authorize diversion or return for credit of any shipment consigned to an overseas destination

Federal Property Management Regulations

§ 101-26.501

which, while en route, cannot be continued onward for any reason and for which the consignee or requisitioning agency cannot provide diversion instructions:

Provided, The frustration occurs at a water or air terminal and title to the material has not passed from the Government. Frustrated shipments located outside the United States are the responsibility of the consignee or ordering agency. However, GSA will assist the agency whenever possible in disposing of the material when it cannot be utilized by the overseas control area of the agency, e.g., oversea command or AID area.

(b) Requests to GSA for disposition instructions shall be directed to the GSA office which made the shipment. Data provided by the agency shall include the original requisition document number, purchase order number (if any), supplementary addresses, and present location of the frustrated shipment. In addition, the agency should furnish the Government bill of lading number or commercial bill of lading reference, and the carrier's freight or waybill number.

(c) GSA may direct disposition of such material through any of the means listed below. Disposition instructions will include a determination by GSA as to the responsibility for payment of transportation costs.

(1) Shipment of material to another consignee.

(2) Temporary storage pending further instructions.

(3) Return to GSA stock.

(4) Disposal by agency.

(5) Disposition through other means if deemed to be in the best interest of the Government.

(d) GSA will provide required documentation to accomplish the desired action and will, if appropriate, initiate necessary adjustments in billing.

(e) Frustrated shipments involving other than GSA stock items will be treated in a manner similar to that prescribed in this §101-26.311 on a case by case basis.

[30 FR 11138, Aug. 28, 1965, as amended at 35 FR 12721, Aug. 11, 1970; 42 FR 58748, Nov. 11, 1977]

Subpart 101-26.4—Federal Supply Schedules [Reserved]

Subpart 101-26.5—GSA Procurement Programs

§ 101-26.500 Scope and applicability of subpart.

(a) This subpart prescribes policies and procedures relating to GSA procurement programs other than the GSA stock and the Federal supply schedule programs. Also excluded are the policies and procedures relating to the procurement of automatic data processing equipment and services set forth in part 101-36.

(b) The policies and procedures in this subpart 101-26.5 are applicable to executive agencies except as otherwise specifically indicated. Federal agencies other than executive agencies may participate in these programs and are encouraged to do so.

[43 FR 32767, July 28, 1978]

§ 101-26.501 Purchase of new motor vehicles.

(a) It shall be the policy to procure commercially available motor vehicles, unless other vehicles are specifically required.

(b) New sedans, station wagons, and light trucks (other than those to be used for law enforcement or where other than standard vehicles are required) shall be procured as follows: Sedans, class IB-subcompact or II-compact; station wagons, class I-subcompact or class II compact vehicles, as described in Federal standard No. 122; and light trucks as defined in Federal standard Nos. 292 and 307. (Federal standard Nos. 122, 292, and 307 as used in this section mean the latest editions.)

Requisitions submitted to GSA for motor vehicles shall be in conformance with the requirements of subpart 101-38.1.

(1) Standard passenger vehicles as defined in Federal standard No. 122 are considered to be completely equipped for ordinary operation and are subject to the maximum statutory price limitation.

(2) Items (vehicles) included in Federal standard No. 122 other than those

listed as standard (basic units) are considered to be equipped with additional systems and equipment for passenger vehicles.

(c) Requisitions submitted to GSA for the acquisition of new passenger vehicles and light trucks under 8500 GVWR (gross vehicle weight rating) shall be in conformance with Pub. L. 94-163 and Executive Order 12375.

(d) New trucks and buses shall be requisitioned in accordance with the provisions of this §101-26.501 and the following:

(1) Light trucks shall be in accordance with Federal standard Nos. 292 and 307; and

(2) Medium and heavy trucks and buses, when not procured from standardized buying programs, shall be in accordance with the latest editions of Federal standard No. 794, Federal specification Nos. KKK-T-2107, 2108, 2109, 2110, 2111, and Federal specification No. KKK-B-1579. Standardized buying programs shall be based on these specifications as appropriate.

(e) Selection of additional systems or equipment in new vehicles shall be made by the requiring agency and shall be based on the need to provide for overall safety, efficiency, economy, and suitability of the vehicle for the purposes intended pursuant to §101-38.104-2.

(1) The essentiality of such systems or equipment shall be weighed against the economic factors involved, the potential benefits to be derived therefrom, and the impact on the fuel consumption characteristics of the vehicle.

(2) Additional systems or equipment requested to be purchased by GSA will be construed to have been determined essential for the effective operation of the vehicle involved by the agency head or a designee. When systems or equipment other than those listed in Federal standards are requested, these systems or equipment shall be considered and treated as deviations under §101-26.501-4(b).

[57 FR 47777, Oct. 20, 1992]

§101-26.501-1 General.

Except as provided for the Department of Defense (DOD) in paragraph (a)

of this section, each executive agency shall submit to GSA for procurement its orders for purchase in the United States of all new passenger motor vehicles (FSC 2310), trucks or truck tractors (FSC 2320), trailers (FSC 2330) van type (with payload of not less than 5,000 nor more than 50,000 pounds), and firetrucks and firefighting trailers (FSC 4210). Specifically included are sedans, station wagons, carryalls, ambulances, buses, and trucks, including trucks with specialized mounted equipment, truck chassis with special purpose bodies, and all van-type trailers (with payload of not less than 5,000 nor more than 50,000 pounds).

(a) DOD shall submit to GSA for procurement its orders for purchase in the United States for all non-tactical vehicles including, but not limited to, commercial-type passenger motor vehicles (FSC 2310), including buses, and trucks and truck tractors (FSC 2320).

(b) When it is determined by the ordering activity that requirements for passenger motor vehicles and trucks indicate the need for procurement by buying activities other than GSA, a request for waiver justifying the procurement shall be submitted in writing to the General Services Administration (GSA), Washington, DC 20406. GSA will notify agencies in writing whether a waiver has been granted. Justification may be based on the urgency of need or the fact that the vehicle has unique characteristics, such as special purpose body or equipment, requiring the agency personnel to closely supervise installation of the equipment by the contractor; e.g., when a medical van is to be equipped with Government- or contractor-supplied equipment. Requests for procurement through sources other than GSA will be handled on an individual basis provided full justification is submitted therefore.

(c) When it is determined by GSA that procurement of an individual agency requirement by GSA would offer no advantage over local purchase of the item, GSA may grant the ordering activity authority for local purchase. When such a determination is made, the order will be returned to the

Federal Property Management Regulations

§ 101-26.501-4

ordering agency with written authority for local purchase.

[38 FR 2176, Jan. 22, 1973, as amended at 43 FR 32767, July 28, 1978; 47 FR 41362, Sept. 20, 1982; 52 FR 29523, Aug. 10, 1987; 57 FR 47777, Oct. 20, 1992]

§ 101-26.501-2 Standardized buying programs.

Wherever practical, requirements for motor vehicles will be satisfied under existing standardized buying programs (Indefinite Quantity, Requirements, Federal Supply Schedule contracts). Agencies not familiar with these programs, or seeking additional information about them, are encouraged to contact the GSA Automotive Commodity Center prior to submitting their orders.

(a) Requirements contracts are in place or anticipated to be in place for the following types of standard motor vehicles:

(1) Medium and heavy trucks:

(i) 4x2 and 6x4 cab-chassis, stake, van, dump, and truck-tractor; 19,000 to 60,000 pounds GVWR.

(ii) 4x4 and 6x4 cab-chassis, stake, dump, and truck-tractor; 26,000 to 52,000 pounds GVWR.

(iii) 1,200 and 2,000 gallon fuel servicing vehicles; and 2,000 gallon aircraft refueler.

(2) Ambulances (in accordance with Federal Specification No. KKK-A-1822): Type I, modular body on cab-chassis; Type II, van body with raised roof; Type III, modular body on van cutaway chassis.

(3) Buses and mini-buses, including school buses:

(i) 32 to 44 adult passenger; 48 to 66 school age passenger.

(ii) 12 to 28 adult passenger; 24 to 42 school age passenger.

(4) Sedans and station wagons (based on standardized, consolidated requirements).

(5) Certain types of light trucks (e.g., conventional carryall, maintenance telephone utility); requirements contracts are established to cover as many types of light trucks as feasible.

(b) Federal Supply Schedule contracts are available to cover certain special purpose motor vehicles, such as

firefighting trucks, waste disposal trucks, and construction equipment.

[57 FR 47777, Oct. 20, 1992]

§ 101-26.501-3 Consolidated purchase program.

(a) Except as noted in §101-26.501(a) and where motor vehicle requirements can not be satisfied under the standardized buying programs described in §101-26.501-2, GSA will continue to make consolidated procurements of all motor vehicle types each year to achieve maximum benefits and economies, as follows:

(1) Family buys—Large annual consolidated buys for sedans, station wagons, and standard light trucks, purchased in the aggregate by group to the extent practical. These procurements are designed to obtain the best market prices available and are normally definite quantity type with maximum option potential. It is anticipated that resulting contracts will remain in place from approximately mid-November to approximately May 1 (or end of model year closeout).

(2) Two (2) volume procurements each year for light trucks of the types covered by Federal standard Nos. 292 and 307, but not covered by standardized buying programs or family buys, as previously described. Requisitions to be included under these two procurements should reach the GSA Automotive Commodity Center by June 15 and December 1 respectively.

(3) Up to three (3) consolidated procurements for medium and heavy trucks and buses of the types covered by Federal standard No. 794, Federal specification Nos. KKK-T-2107, 2108, 2109, 2110, 2111, and Federal specification No. KKK-B-1579.

(b) Requirements not covered by Federal standards 122, 292, 307, or 794 shall conform with the provisions of §101-26.501-4.

[57 FR 47777, Oct. 20, 1992]

§ 101-26.501-4 Submission of orders.

Orders for all motor vehicles shall be submitted on GSA Form 1781, Motor Vehicle Requisition, or DD Form 448, Military Interdepartmental Purchase

§ 101-26.501-5

41 CFR Ch. 101 (7-1-01 Edition)

Request (MIPR), to the General Services Administration, Automotive Commodity Center (FCA), Washington, DC 20406, and shall contain required FEDSTRIP data for mechanized processing. The Department of Defense shall ensure that appropriate MILSTRIP data are entered on DD Form 448.

(a) Requisitions covering vehicle types not included in Federal standard Nos. 122, 292, 307, or 794, in a military specification, or in an agency specification on file with GSA, shall contain complete descriptions of the vehicles required, the intended use of the vehicles, and terrain in which the vehicles will be used.

(b) Requisitions for vehicles within the category of Federal standard Nos. 122, 292, 307, or 794, but for which deviations from such standards are required, unless already waived by the Director, Automotive Commodity Center (FCA), Federal Supply Service, GSA, Washington, DC 20406, shall include with the requisition a justification supporting each deviation from the standards and shall contain a statement of the intended use of the vehicles, including a description of the terrain in which the vehicles will be used. Prior approval of deviations shall be indicated on the requisitions by citing the waiver authorization number.

(c) GSA Form 1781, Motor Vehicle Requisition, has been specifically designed for agency use to expedite ordering of all vehicles. Agencies are requested to use GSA Form 1781 as a single-line-item requisition for non-standard as well as standard vehicles. When ordering standard vehicles, the appropriate standard item number for such vehicles equipped to meet specific operational needs may be selected from the applicable table in the Federal standards. Additional systems and equipment may be added by inserting in the "Option Codes" portion of the form the appropriate code for the selected items from the table of options in the standard. When ordering non-standard vehicles or options, the instructions on the reverse of GSA Form 1781, properly completed, will satisfy the requirements regarding the submission of requisitions as set forth in paragraph (a) of this section.

(d) Each requisition shall indicate the appropriation fund code to be charged and must bear the original signature of an officer authorized to obligate cited funds.

(e) Separate requisitions shall be submitted for each vehicle type and consignee.

[57 FR 47778, Oct. 20, 1992]

§ 101-26.501-5 Procurement time schedules.

(a) Requisitions covering vehicle types included in Federal standard Nos. 122, 292, 307, 794, Federal specification Nos. KKK-T-2107, 2108, 2109, 2110, 2111, and Federal specification No. KKK-B-1579 will be procured either under a standardized buying program, as described in §101-26.501-2, or a consolidated purchase program, as described in §101-26.501-3, unless a statement is included justifying the need for delivery other than the delivery times indicated in this section. Requisitions containing a statement of justification will be handled on an emergency basis in accordance with §101-26.501-5(b).

(b) *Emergency requirements.* Emergency requirements will receive special handling only when the requisitions are accompanied by adequate justification for individual purchase action. Every effort will be made to meet the delivery date specified in the requisition.

(c) *Delivery time.* Delivery times for motor vehicle requirements will range widely depending on method of purchase.

(1) *Existing contracts.* Delivery times for motor vehicle requirements submitted and placed against existing in-place contracts (family buy option, requirements contract or Federal Supply Schedule contract) will range from 60 to 150 days from date of purchase order.

(2) *Volume consolidated procurements.* Delivery times for motor vehicle requirements submitted for volume consolidated purchases will range from 210 to 330 days after solicitation consolidation date. Included in delivery time estimates are 90 to 105 days required for soliciting and receiving offers, 30 to 60 days for evaluation and award of contracts, 90 to 180 days from date of

Federal Property Management Regulations

§ 101-26.501-9

award for delivery of vehicles to destination (dealer or consignee, as applicable).

(3) For buses, ambulances, and other special duty vehicles which can not be procured under the standardized buying programs or consolidated purchase programs described in §§101-26.501-2 and 101-26.501-3, 240 to 270 days from date of award are usually required to effect delivery. However, special purpose vehicles with unique characteristics, such as certain types of firetrucks, may require longer delivery. In such instances, every effort will be made by GSA to facilitate deliveries and keep the requisitioning agencies informed of any unauthorized delay.

[57 FR 47778, Oct. 20, 1992]

§ 101-26.501-6 Forms used in connection with delivery of vehicles.

(a) *GSA Form 1398, GSA Purchased Vehicle*. This form is used by the contractor to indicate that preshipment inspection and servicing of each vehicle has been performed. The contractor is required to complete GSA Form 1398 (illustrated at §101-26.4902-1398) and affix it, preferably, to the lock face or door frame of the right front door after the final inspection. The form should be left in place during the warranty period to permit prompt identification of vehicles requiring dealer repairs pursuant to the warranty.

(b) *Standard Form 368, Quality Deficiency Report (Category II)*. GSA is constantly striving to improve customer service and the quality of motor vehicles for which it contracts. To inform contractors of the deficiencies noted during the life of the vehicles, Standard Form 368 shall be prepared by the consignee and sent to GSA describing details of vehicle deficiency and action taken for correction. Procedures for documenting and reporting quality deficiencies are set forth in the GSA Publication "Discrepancies or Deficiencies in GSA or DOD Shipments, Material or Billings." Agencies are urged to report all deficiencies to GSA irrespective of satisfactory corrective action taken by the manufacturer's authorized dealer. If the dealer refuses to take corrective action on any vehicle within its warranty period, the report shall so state and include an explanation of cir-

cumstances. Standard Form 368 shall also be used to report all noncompliance with specifications or other requirements of the purchase order.

(c) *Instructions to Consignee Receiving New Motor Vehicles Purchased by General Services Administration*. This information is printed on the reverse of the consignee copy of the delivery order. Personnel responsible for receipt and operation of Government motor vehicles should be familiar with the instructions and information contained in the document entitled "Instructions to Consignee Receiving New Motor Vehicles Purchased by General Services Administration."

[41 FR 34631, Aug. 16, 1976, as amended at 43 FR 32768, July 28, 1978; 52 FR 29524, Aug. 10, 1987; 57 FR 47778, Oct. 20, 1992]

§ 101-26.501-7 Sale of vehicles.

GSA will not solicit trade-in bids when purchasing new motor vehicles for replacement purposes because experience has shown that suppliers (manufacturers) are unwilling to accept used vehicles in part payment for new ones. Accordingly, used vehicles that are being replaced will be disposed of by sale as set forth in Part 101-46.

[57 FR 47779, Oct. 20, 1992]

§ 101-26.501-8 [Reserved]

§ 101-26.501-9 Centralized motor vehicle leasing program.

GSA has a centralized leasing program to provide an additional source of motor vehicle support to all Federal agencies. This program relieves Federal agencies that use it from both the time constraints and administrative costs associated with independently entering into lease contracts. The centralized leasing program covers subcompact, compact, and midsize sedans, station wagons, and certain types of light trucks (pickups and vans). Participation in the centralized leasing program is mandatory on all executive agencies of the Federal Government (excluding the Department of Defense and the U.S. Postal Service) within the 48 contiguous States and Washington, DC. However, agencies must obtain GSA authorization to lease in accordance with §101-39.205 prior to using

§ 101-26.502

these established mandatory use contracts. For further information on existing contracts, including vehicles covered, rates, and terms and conditions of the contract(s), contact General Services Administration (FCA), Washington, DC 20406.

[52 FR 29525, Aug. 10, 1987]

§ 101-26.502 U.S. Government National Credit Card.

A waiver has been issued by the Government Printing Office to GSA for the procurement of the printing of Standard Form 149, U.S. Government National Credit Card.

[60 FR 19674, Apr. 20, 1995]

§ 101-26.503 Multiple award schedule purchases made by GSA supply distribution facilities.

GSA supply distribution facilities are responsible for quickly and economically providing customers with frequently needed common-use items. Stocking a variety of commercial, high-demand items purchased from FSS multiple award schedules is an important way in which GSA supply distribution facilities meet this responsibility.

[60 FR 19675, Apr. 20, 1995]

§ 101-26.504 [Reserved]

§ 101-26.505 Office and household furniture and furnishings.

Requirements for new office and household furniture and furnishings as described in this §101-26.505 shall be satisfied from GSA stock or Federal Supply Schedule contracts to the extent that agencies are required to use these sources. Requirements for items not obtainable from these sources may be satisfied by any Federal agency through GSA special buying services upon agency request pursuant to the provisions of §101-26.102. Before initiating a procurement action for new items, items on hand should be redistributed, repaired, or rehabilitated, as feasible, pursuant to §101-26.101

[43 FR 22211, May 24, 1978]

41 CFR Ch. 101 (7-1-01 Edition)

§ 101-26.505-1 Description of office and household furniture.

(a) Office furniture is equipment normally associated with occupancy or use in such areas as offices, conference and reception rooms, institutional waiting rooms, lobbies, and libraries. Such equipment includes desks, tables, credenzas, bookcases, coat racks, telephone cabinets, filing sections and cabinets, office safes, security cabinets, chairs, and davenports.

(b) Household furniture is equipment normally associated with occupancy or use in areas such as housekeeping and nonhousekeeping quarters, reception rooms, and lobbies. Such equipment includes davenports, chairs, tables, buffets, china cabinets, beds, wardrobes, and chests.

[33 FR 14959, Oct. 5, 1968]

§ 101-26.505-2 Description of office and household furnishings.

(a) Office furnishings are articles which supplement office furniture and augment the utility of the space assigned. These articles include lamps, desk trays, smoking stands, waste receptacles, carpets, and rugs.

(b) Household furnishings are articles which supplement household furniture and add to the comfort or utility of the space assigned. Such articles include lamps, mirrors, carpets, rugs, and plastic shower and window curtains.

[33 FR 14959, Oct. 5, 1968]

§ 101-26.505-3 Requests to procure similar items from sources other than GSA supply sources.

When an agency required to obtain items of office and household furniture and furnishings from GSA stock or Federal Supply Schedule contracts determines that items available from these sources will not serve the required functional end use, requests to procure similar items from other than GSA sources shall be submitted for consideration in accordance with §101-26.100-2.

[41 FR 34632, Aug. 16, 1976]

Federal Property Management Regulations

§ 101-26.506-5

§§ 101-26.505-4—101-26.505-6 [Reserved]

§ 101-26.505-7 GSA assistance in selection of furniture and furnishings.

The Customer Service Representative in each GSA regional office will, upon request, furnish agencies with information on the types, styles, finishes, coverings, and colors of office and household furniture and furnishings available through the GSA purchase program. (See § 101-26.506.)

[43 FR 22211, May 24, 1978]

§ 101-26.506 Interior planning and design services.

In addition to the assistance provided in the selection of furniture and furnishings as specified in § 101-26.505-7, the GSA Public Buildings Service, through facilities located in each region, will assist Federal activities within the United States, the Commonwealth of Puerto Rico, and the Virgin Islands in various phases of interior planning and design. These services will be provided either directly or through commercial sources. (For services involving space layout, see § 101-17.400.)

[41 FR 42953, Sept. 29, 1976]

§ 101-26.506-1 Types of service.

GSA interior planning and design services consist of data gathering and organizational analysis; development of a space requirements program; softline space plans; development of an interior design program (to include finish materials, furniture and furnishing specifications, and procurement data); and complete floor plans for telephones, electrical outlets, partitions, furniture, and equipment. The items specified for procurement will be selected from approved GSA sources of supply.

[41 FR 42953, Sept. 29, 1976]

§ 101-26.506-2 Limitations.

(a) When furniture and furnishings requirements have been developed in connection with interior planning and design services furnished by GSA, the requesting agency shall determine that such requirements are in consonance with the criteria for acquisition of fur-

niture and furnishings as provided in §§ 101-25.302 and 101-25.404.

(b) Furniture and furnishings to be obtained in connection with interior planning and design services furnished by GSA shall be acquired, to the extent available, from GSA stock or through Federal Supply Schedules in accordance with the provisions of §§ 101-26.301 and 101-26.401.

[31 FR 9797, July 20, 1966, as amended at 43 FR 22211, May 24, 1978]

§ 101-26.506-3 Submission of requests.

Requests for interior planning and design services shall be submitted on Standard Form 81, Request for Space (illustrated at § 101-17.4901-81), and forwarded to PBS in the GSA regional office serving the geographic area of the requesting agency. Requests shall include the following information:

- (a) Type of space in terms of its use;
- (b) Location;
- (c) Floor plans, if available;
- (d) Occupancy date;
- (e) Amount of funds available for the project; and
- (f) Name, address, title, and telephone number of requesting official.

[41 FR 42953, Sept. 29, 1976]

§ 101-26.506-4 Acceptance and processing of requests.

Agency requests for interior planning and design service will be reviewed and if considered feasible, will be accepted. Upon acceptance of a request by GSA, a proposal will be furnished the requesting activity for review and approval within 30 days. The proposal will include the following:

- (a) Approximate date the work can be started;
- (b) Estimated completion date of planning and design services;
- (c) The amount to be reimbursed GSA for the services; and
- (d) Other pertinent data or recommendations.

[31 FR 9797, July 20, 1966]

§ 101-26.506-5 Reimbursement for services.

If the GSA proposal is acceptable, a purchase order, requisition, or other funded authorization document shall be issued to the GSA office named in

§ 101-26.507

the proposal. GSA will bill the office indicated in the order or authorization for the amount specified in the proposal. The reimbursement procedures are designed to recover GSA's direct cost for providing these services. Any changes in the scope of the project requested by the requisitioning agency prior to its completion may require a revision in the amount of the reimbursable charges and the time schedule for completion.

[31 FR 9797, July 20, 1966]

§ 101-26.507 Security equipment.

Federal agencies and other activities authorized to purchase security equipment through GSA sources shall do so in accordance with the provisions of this § 101-26.507. Under section 201 of the Federal Property and Administrative Services Act of 1949 (40 U.S.C. 481), the Administrator of GSA has determined that fixed-price contractors and lower tier subcontractors who are required to protect and maintain custody of security classified records and information may purchase security equipment from GSA sources. Delivery orders for security equipment submitted by such contractors and lower tier subcontractors shall contain a statement that the security equipment is needed for housing Government security classified information and that the purchase of such equipment is required to comply with the security provision of a Government contract. In the event of any inconsistency between the terms and conditions of the delivery order and those of the Federal Supply Schedule contract, the latter shall govern. Security equipment shall be used as prescribed by the cognizant security office.

[60 FR 19675, Apr. 20, 1995]

§ 101-26.507-1 Submission of requisitions.

Requisitions for security equipment covered by the latest edition of Federal specifications AA-F-357, AA-F-358, AA-F-363, AA-S-1518, and AA-D-600, and interim Federal specifications AA-F-00364 and AA-C-001697 shall be submitted in FEDSTRIP format to the GSA regional office supporting the geographic area in which the requisitioner

41 CFR Ch. 101 (7-1-01 Edition)

is located. GSA will consolidate requisitions for these items from all regions for procurement on a definite quantity basis.

[43 FR 32765, July 28, 1978]

§ 101-26.507-2 Procurement time schedule.

Requisitions for security equipment will be consolidated by GSA on January 31, April 30, July 31, and October 31 of each year. The consolidated requisitions will be used in executing definite quantity contracts. To ensure inclusion in the invitation for bids, requisitions shall be submitted to GSA on or before January 1, April 1, July 1, or October 1 as appropriate. Requisitions received after any of these dates normally will be carried over to the subsequent consolidation date. Approximately 180 calendar days following the consolidation dates should be allowed for initial delivery. Requisitions shall include a required delivery date which reflects anticipated receipt under the time schedule.

[43 FR 32765, July 28, 1978]

§ 101-26.507-3 Purchase of security equipment from Federal Supply Schedules.

To ensure that a readily available source exists to meet the unforeseen demands for security equipment, Federal Supply Schedule contracts have been established to satisfy requirements that are not appropriate for consolidated procurement and do not exceed the maximum order limitations.

[60 FR 19675, Apr. 20, 1995]

§ 101-26.507-4 Quantities in excess of the maximum order limitation.

Quantities exceeding the maximum order limitation on Federal Supply Schedules will also be consolidated and procured by GSA pursuant to § 101-26.507-2. Where quantities are required to be delivered before the time frames established for the quarterly consolidated procurement, the requisition must indicate the earlier required delivery. As necessary, separate procurement action will be taken by GSA to satisfy the requirements.

[41 FR 34632, Aug. 16, 1976]

Federal Property Management Regulations

§ 101-26.508-2

§ 101-26.508 Electronic data processing (EDP) tape and instrumentation tape (wide and intermediate band).

Procurement by Federal agencies of EDP tape and instrumentation tape (wide and intermediate band) shall be accomplished in accordance with the provisions of this § 101-26.508.

[38 FR 2176, Jan. 22, 1973]

§ 101-26.508-1 Requisitioning data processing tape available through Federal Supply Schedule contracts.

Federal Supply Schedules, FSC group 70, part XI, and FSC group 58, part V, section C, include contracts to satisfy Government requirements for those types of EDP tape and instrumentation tape (wide and intermediate band) which are most widely used. Federal agencies located within the 48 contiguous United States, Washington, DC and Hawaii (applicable to EDP tape only for Hawaii) shall procure these tapes in accordance with the provisions of the current schedules and this § 101-26.508-1. Orders not exceeding the maximum order limitations of the Federal Supply Schedules and prepared directly by activities located outside the geographical areas referenced above shall, to the extent possible, be consolidated and submitted in FEDSTRIP format to the GSA regional office supporting the geographic area in which the requisitioner is located.

[43 FR 32765, July 28, 1978]

§ 101-26.508-2 Requisitioning data processing tape not available from Federal Supply Schedule contracts.

(a) Requisitions for types of EDP tape and instrumentation tape (wide and intermediate band) covered by Federal Supply Schedule contracts which exceed the maximum order limitations of the schedule shall be submitted to the GSA regional office supporting the geographic area in which the requisitioner is located.

(b) Requisitions for all types of EDP tape and instrumentation tape (wide and intermediate band) not covered by Federal Supply Schedule contracts shall be submitted to GSA for purchase action when the dollar value of the requisitions exceeds, or is estimated to ex-

ceed, \$2,500 for EDP tape and \$5,000 for instrumentation tape. However, regardless of the amount involved (including requisitions estimated to be less than the dollar limitations referenced above), purchase action shall not be taken by GSA or an agency unless a waiver of the requirement for using items of tape available from Federal Supply Schedule contracts has been furnished in accordance with § 101-26.100-2.

Requests for waivers shall be submitted to the Commissioner, Federal Supply Service (F), General Services Administration, Washington, DC 20406. The requests shall fully describe the type of tape required and state the reasons Federal Supply Schedule items will not adequately serve the agency's needs. GSA will notify the requesting agency in writing of the action taken on the requests. To reduce leadtime, requisitions may be submitted in FEDSTRIP format with the requests for waivers. Requisitions for which a waiver has first been obtained shall be submitted with a copy of the waiver to the GSA regional office supporting the geographic area in which the requisitioner is located. GSA will either arrange for procurement of the items or authorize the requesting agency to procure them.

(c) When establishing required delivery dates in purchase requests submitted in accordance with this § 101-26.508-2, agencies should normally allow 105 days leadtime to permit orderly procurement by GSA. In addition to this 105 days leadtime, inspection and testing of the tape requires approximately 15 days.

(d) When an agency submitting a purchase request in accordance with this § 101-26.508-2 has a need for scheduled deliveries, minimum or maximum order quantities, or other special arrangements, GSA will develop specific provisions to accommodate the needs. The provisions will be based on information furnished by the agency concerned and will be included in solicitations for offers and resultant contracts.

[37 FR 20941, Oct. 5, 1972, as amended at 41 FR 34633, Aug. 16, 1976; 43 FR 32765, July 28, 1978]

§ 101-26.508-3 Consolidation of requisitions.

To the maximum extent feasible, agencies shall develop procedures which will permit planned consolidated requisitioning of EDP tape and instrumentation tape (wide and intermediate band) on an agencywide basis. When agencywide consolidation is not feasible, consideration shall be given to the consolidation of individual requisitions for small quantities at any agency level. This will enable the Government to benefit from lower prices generally obtainable through large volume procurements.

[43 FR 32766, July 28, 1978]

§ 101-26.509 Tabulating machine cards.

Procurement by Federal agencies of tabulating machine cards shall be made in accordance with the provisions of this § 101-26.509.

[37 FR 24113, Nov. 14, 1972]

§ 101-26.509-1 Requisitioning tabulating machine cards available from Federal Supply Schedule contracts.

Federal Supply Schedule, FSC group 75, part VIII, includes contracts for tabulating cards applicable to electrical and mechanical contact tabulating machines, including aperture cards and copy cards. Federal agencies shall procure these cards in accordance with the provisions of the current schedule. Orders not exceeding the maximum order limitation of the Federal Supply Schedule and prepared directly by activities located outside the geographical delivery areas specified in the schedule shall be submitted in FEDSTRIP format to the GSA regional office supporting the geographic area in which the requisitioner is located.

[43 FR 32766, July 28, 1978]

§ 101-26.509-2 Requisitioning tabulating machine cards not available from Federal Supply Schedule contracts.

(a) Requisitions for tabulating machine cards covered by Federal Supply Schedule contracts which exceed the maximum order limitation of the schedule shall be forwarded in FEDSTRIP format to the GSA regional

office supporting the geographic area in which the requisitioner is located.

(b) Requisitions for tabulating machine cards not covered by Federal Supply Schedule contracts shall be submitted to GSA for purchase action if the dollar value of the cards exceeds or is estimated to exceed \$2,500. However, regardless of the amount involved (including requisitions estimated to be \$2,500 or less), purchase action shall not be taken by GSA or an agency unless a waiver of the requirement for the use of tabulating cards available from Federal Supply Schedule contracts has been furnished in accordance with § 101-26.100-2. Requests for waivers shall be submitted to the Commissioner, Federal Supply Service (F), General Services Administration, Washington, DC 20406. The requests shall fully describe the items required and state the reasons the tabulating machine cards covered by the Federal Supply Schedule contracts will not adequately serve the end-use purpose. GSA will notify the requesting agency in writing of the action taken on the waiver request. To reduce leadtime, requisitions may be submitted in FEDSTRIP format with the requests for waivers. A requisition for items for which a waiver has first been obtained shall be submitted with a copy of the waiver to the GSA regional office supporting the geographic area in which the requisitioner is located. GSA will either arrange for procurement of the items or authorize the requesting activity to procure them.

(c) Purchase requests with established delivery dates should allow sufficient leadtime (see § 101-26.102-3) to permit orderly procurement by GSA, including acceptance testing and delivery to destination.

(d) In those instances where an agency anticipates a need for scheduled deliveries, minimum or maximum order quantities, or other special arrangements, GSA will develop specific provisions to accommodate the needs of the particular agency. These provisions will be based on information furnished by the agency concerned for inclusion in solicitations for offers and resultant contracts.

[35 FR 13440, Aug. 22, 1970, as amended at 43 FR 22212, May 24, 1978; 43 FR 32766, July 28, 1978]

Federal Property Management Regulations

§ 101-26.602-1

§ 101-26.509-3 Consolidation of requisitions.

To the maximum extent feasible, agencies shall consolidate their requisitions for tabulating machine cards on an agencywide basis. If agencywide consolidation is not feasible, consideration shall be given to the consolidation of requisitions at any agency level when the Government will benefit from lower prices through large-volume procurement.

[43 FR 32766, July 28, 1978]

Subpart 101-26.6—Procurement Sources Other Than GSA

§ 101-26.600 Scope and applicability of subpart.

This subpart prescribes the policies, procedures, and limitations relating to civil agency use of procurement sources of the Department of Defense (DOD), which include the Defense supply centers of the Defense Logistics Agency (DLA) and the inventory control points of the military departments. The provisions of this subpart 101-26.6 are applicable to executive agencies unless otherwise specifically indicated. Other Federal agencies are encouraged to satisfy their requirements in the same manner.

[42 FR 58748, Nov. 11, 1977]

§ 101-26.601 [Reserved]

§ 101-26.602 Fuels and packaged petroleum products obtained from or through the Defense Logistics Agency.

(a) Agencies shall be governed by the provisions of this §101-26.602 in satisfying requirements for coal, natural gas from sources other than a public utility, petroleum fuels, and certain petroleum products from or through the Defense Logistics Agency.

(b) The Defense Logistics Agency has been assigned the supply responsibility for these materials which will be available either from contracts (or contracts summarized in contract bulletins) issued by the Defense Fuel Supply Center, Alexandria, Va., or through FEDSTRIP/MILSTRIP requisitions placed on the Defense General Supply Center, Richmond, Va., in accordance

with instructions contained in §101-26.602-2. Agencies submitting estimates of requirements which are summarized in the Defense Fuel Supply Center contract bulletins are obligated to procure such requirements from these contracts. Estimates submitted shall not include requirements normally obtained through service station deliveries utilizing the U.S. Government National Credit Card.

[42 FR 58748, Nov. 11, 1977 as amended at 57 FR 21895, May 26, 1992]

§ 101-26.602-1 Procurement of lubricating oils, greases, and gear lubricants.

(a) The Defense Fuel Supply Center will make annual procurements of lubricating oils, greases, and gear lubricants for ground type (nonaircraft) equipment and of aircraft engine oils on an annual program basis. Estimates of requirements for items covered by these programs will be solicited annually from agencies on record with the Defense Fuel Supply Center in time for the requirements to arrive at the Center on the following schedule:

	Purchase program	Due on or before
Lubricating oils (nonaircraft).	4.1	November 15.
Aircraft engine oils	4.2	June 15.
Grease and gear oils	4.4	October 15.

(b) Activities not on record but requiring procurement support shall submit requests to: Commander, Defense Fuel Supply Center, Attn: DFSC:PG, Cameron Station, Alexandria, VA 22314, on or before the requirement due dates specified in §101-26.602-1(a). Submission of requirements is not required if:

- (1) The maximum single order is less than the minimum quantity obtainable under the bulletin;
- (2) Container sizes are smaller than those available under the bulletin; or
- (3) Purchase without regard to existing Defense Fuel Supply Center contracts is otherwise authorized.

(c) Agency requirements will be consolidated and solicited for procurement by the Defense Fuel Supply Center. Contractual action to obtain coverage for these programs will be summarized in a contract bulletin for program 4.1

§ 101-26.602-2

41 CFR Ch. 101 (7-1-01 Edition)

and 4.4. Copies of the bulletins (copies of contracts for program 4.2) will be distributed to addresses provided by the agencies on record.

(d) Deliveries of lubricants covered by Defense Fuel Supply Center contracts shall be obtained by activities in the United States by following the instructions contained in the respective contracts or contract bulletins.

[34 FR 19977, Dec. 20, 1969, as amended at 39 FR 33315, Sept. 17, 1974]

§ 101-26.602-2 Procurement of packaged petroleum products.

(a) Packaged petroleum products listed in Federal Supply Catalog for Civil Agencies shall be obtained by submitting requisitions prepared in accordance with the FEDSTRIP Operating Guide (FPMR 101-26.2) to the Defense General Supply Center (DGSC), Richmond, Va. 23297, using routing identifier code S9G. The Federal Supply Catalog for Civil Agencies may be obtained, upon written request, from the Commander, Defense Logistics Services Center, Attn: DLSC-T, Battle Creek, Mich. 49016. Requisitions for packaged petroleum items not in this catalog and not otherwise included in Defense Fuel Supply Center (DFSC) procurements under the provisions of §101-26.602-1 may be submitted to DGSC. DGSC will supply the items from inventory or will refer the requisitions to DFSC for purchase and direct delivery to the requisitioner. Packaged petroleum items may be obtained from other Federal activities by agreement with the activity concerned or by local purchase when such action is authorized under the provisions of the Defense Logistics Agency (DLA) local purchase policy contained in paragraph (b) of this section.

(b) Activities may effect local purchase of any DLA-managed, centrally procured item, commercially available, provided the purchase:

(1) Is limited to immediate-use requirements generated by emergency conditions (e.g., work stoppage, etc.), or

(2) Is to satisfy a routine requirement having a total line value not in excess of \$25 and is determined to be the most economical method of supply.

(c) DGSC may return requisitions for local purchase action citing FEDSTRIP/MILSTRIP status code CW with the concurrence of the requisitioning activity when it is deemed that a local purchase action would be the most economical method of supply. A determination will be based on recognition of excessive costs (procurement, transportation/shipping, and special packaging considerations) as compared to those costs associated with local purchase action. Requisition priorities, backorder situations, procurement and required delivery dates (PDD/RDD), and requisition line item dollar values shall not be a basis or consideration for a Status Code CW reject action. Requisitions from overseas activities will not be returned to overseas activities for a local purchase action.

[37 FR 668, Jan. 15, 1972, as amended at 42 FR 58748, Nov. 11, 1977]

§ 101-26.602-3 Procurement of gasoline, fuel oil (diesel and burner), kerosene, and solvents.

(a) Estimates of annual requirements will be solicited annually by the Defense Fuel Supply Center from agencies on record so as to reach that activity approximately 45 calendar days before the due date shown in Defense Fuel Supply Center geographic alignment of States set forth in §101-26.602-3 (d) and (e). The requirements call will be accomplished by mailing a computer-produced record of the file data for each delivery point that has been identified to each submitting addressee; instructions for validation and return will be included. Activities not on record but requiring procurement support shall prepare and submit estimates on DFSC Form 15:18 to the Defense Fuel Supply Center, Cameron Station, Alexandria, VA 22314. An illustration of DFSC Form 15:18 is contained in §101-26.4904-1518. Copies may be obtained on request from: Commander, Defense Fuel Supply Center, Attention: DFSC-OD, Cameron Station, Alexandria, VA 22314.

(1) Estimated annual requirements for any delivery point which total less than the following minimums shall not be submitted to the Defense Fuel Supply Center, unless the activity does not

Federal Property Management Regulations

§ 101-26.602-3

have authority or capability to procure locally.

Item	Minimum annual requirement (gallons)
Gasoline	10,000
Burner fuel oil	10,000
Diesel oil	10,000
Kerosene	10,000
Solvents	500

(2) Estimates shall not be submitted when the minimum quantities to be delivered to any one point on a single delivery are less than the following minimums, unless the activity does not have the authority or capability to procure locally.

Delivery method	Minimum quantity furnished on a single delivery
Drums	4 drums (200-220 gallons).
Tank wagon	50 gallons.
Transport truck	Full truckload (5,200-7,500 gallons).
Tank car	Full carload (8,000-12,000 gallons).

(b) Agency requirements will be solicited for procurement by the Defense Fuel Supply Center, and contracts resulting from these solicitations will be summarized in contract bulletins, separately for each Defense Fuel Supply Center geographic region, and distributed to agencies on record. Activities requiring additional contract bulletins shall submit requests to: Commander, Defense Fuel Supply Center, Attention: DFSC—OD, Cameron Station, Alexandria, VA 22314.

(c) The items covered in contract bulletins issued by the Defense Fuel Supply Center are in accordance with the latest issue of the applicable Federal specification. Agency requirements submitted for products not under a Federal specification must include accurate and complete product laboratory analysis.

(d) The following illustrates the Defense Fuel Supply Center geographic alignment of the States, the delivery periods covered for each region, the identification of purchase programs, and the due dates for submission of requirements for motor gasoline, fuel oil (diesel and burner), and kerosene.

MOTOR GASOLINE, FUEL OILS (DIESEL AND HEATING), AND KEROSENE

State	Delivery period	Requirements due date
Alaska—Purchase Program 3.9 ¹ .	July 1—June 30	January 1.
Hawaii—Purchase Program 3.1.	January 1—December 31.	July 1.
DFSC Region 1—Purchase Program 3.21:		
Connecticut	September 1—August 31.	March 1.
Mainedo	Do.
Massachusettsdo	Do.
New Hampshiredo	Do.
Rhode Islanddo	Do.
Vermontdo	Do.
DFSC Region 2—Purchase Program 3.22:		
New Jersey	October 1—September 30.	April 1.
New Yorkdo	Do.
Pennsylvaniado	Do.
DFSC Region 3—Purchase Program 3.23:		
Delaware	August 1—July 31.	February 1.
District of Columbiado	Do.
Indianado	Do.
Kentuckydo	Do.
Marylanddo	Do.
Ohiodo	Do.
Tennesseedo	Do.
Virginiado	Do.
West Virginiado	Do.
DFSC Region 4—Purchase Program 3.24:		
Alabama	April 1—March 31.	October 1.
Arkansasdo	Do.
Floridado	Do.
Georgiado	Do.
Louisianado	Do.
Mississippido	Do.
Missourido	Do.
North Carolinado	Do.
South Carolinado	Do.
Puerto Ricodo	Do.
Virgin Islandsdo	Do.
DFSC Region 5—Purchase Program 3.25:		
Illinois	May 1—April 30	Nov. 1.
Iowado	Do.
Michigando	Do.
Minnesotado	Do.
Wisconsindo	Do.
DFSC Region 6—Purchase Program 3.26:		
Colorado.....do	June 1—May 31	December 1.
Kansasdo	Do.
Nebraskado	Do.
New Mexicodo	Do.
North Dakotado	Do.
Oklahomado	Do.
South Dakotado	Do.
Texas	June 1—May 31	December 1.
Wyomingdo	Do.
DFSC Region 7—Purchase Program 3.27:		
Arizona	November 1—October 31.	May 1.
Californiado	Do.
Nevadado	Do.

§ 101-26.602-4

41 CFR Ch. 101 (7-1-01 Edition)

MOTOR GASOLINE, FUEL OILS (DIESEL AND HEATING), AND KEROSENE—Continued

State	Delivery period	Requirements due date
Utahdo	Do.
DFSC Region 8—Purchase Program 3.28:		
Idaho	July 1–June 30	January 1.
Montanado	Do.
Oregondo	Do.
Washingtondo	Do.

¹ Includes solvents.

NOTE: Program 3.23 does not include requirements for those activities supported by the GSA Region 3 Fuel Yard.

(e) Estimates of requirements for solvents to be delivered in the continental United States, Puerto Rico, and the Virgin Islands during the period January 1 through December 31 shall be submitted to arrive at the Defense Fuel Supply Center by the preceding July 1. The purchase program identification is 3.11.

(f) Estimates of requirements for aviation fuels for delivery in the United States shall be submitted in accordance with section 11, chapter 1, of DOD 4140.25–M, Procedures for the Management of Petroleum Products.

(g) Requirements for aviation fuels (all grades) shall be submitted in accordance with DFSC Regulation 4220.1, Requirements Submission Schedule for Petroleum Products. Copies of DFSCR 4220.1 may be obtained from the Defense Fuel Supply Center (DFSC–W), Cameron Station, Alexandria, Va. 22314.

(h) Requirements for petroleum fuels at locations other than as identified in this §101-26.602-3 may be obtained from other Federal activities by agreement with the activity concerned or from local purchase sources, when local purchase authority and capability exists, or by submitting requests direct to the Defense Fuel Supply Center, Attention: DFSC–OD, Cameron Station, Alexandria, Va. 22314, if centralized procurement is desired.

[34 FR 19978, Dec. 20, 1969, as amended at 39 FR 33316, Sept. 17, 1974; 42 FR 58749, Nov. 11, 1977; 47 FR 4682, Feb. 2, 1982]

§ 101-26.602-4 Procurement of coal.

(a) Federal agencies desiring to participate in the Defense Fuel Supply Center coal contracting program for carload delivery outside the District of Columbia and vicinity may obtain coal through this program by submitting estimates as provided in this §101-26.602-4.

(b) Estimates of coal requirements shall be prepared on DD Form 416, Requisition for Coal, Coke, or Briquettes (illustrated as §101-26.4904-416), clearly marked “Estimate Only”, and submitted in original and one copy to arrive at the Defense Fuel Supply Center, Cameron Station, Alexandria, Va. 22314, before the following requirement due dates:

Purchase program	For activities located in	Requirements due in DFSC by	For delivery beginning
5.5	Indiana, Illinois, Iowa, Kansas, Missouri, South Dakota, West Tennessee, West Kentucky, Wisconsin.	June 1	December 1.
5.9 (Lignite)	North Dakotado	Do.
5.3	Alabama, East Kentucky, East Tennessee, Ohio, Georgia, North Carolina, South Carolina, West Virginia.	August 15	April 1.
5.8 (Anthracite)	Connecticut, District of Columbia, Maryland, Massachusetts, New Jersey, New York, Pennsylvania, Virginia, South Carolina.	November 1	May 1.
5.4	Michigan, Minnesota, North Dakota, Wisconsindo	Do.
5.7	Alaskado	Do.
5.2	District of Columbia, Maryland, New Jersey, Pennsylvania, Virginia.	January 15	August 1.
5.1	Connecticut, Maine, Massachusetts, New Hampshire, New York, Vermont.	April 1	October 1.
5.6	Arizona, California, Colorado, Idaho, Montana, New Mexico, Oregon, Utah, Washington, Wyoming.do	Do.

NOTE: Except for purchase programs 5.8 and 5.9 all programs refer to requirements for bituminous coal.

(1) A separate requirement form shall be prepared for each delivery point and for each size and kind of coal, such as bituminous, anthracite, or lignite. The

Federal Property Management Regulations

§ 101-26.602-5

purchase program number is to be entered in the upper right hand block of DD Form 416.

(2) The section of DD Form 416 entitled "Analytical Specifications Required" shall reflect minimum requirements based on heating engineering data applicable to the particular equipment in which the coal will be used.

(c) Contractual information covering these requirements will be furnished each participating agency by the Defense Fuel Supply Center after contracts are awarded. As shipments of coal are required, each activity shall direct the contractor to make delivery. Payment for deliveries shall be arranged for by the ordering activity directly with the contractor. Should estimated requirements not be needed due to changes or conversions in heating equipment or other reasons, activities shall notify the Defense Fuel Supply Center of such changes as soon as possible.

(d) Copies of DD Form 416 may be obtained from: Commander, Defense Fuel Supply Center, Attention: DFSC:PE, Cameron Station, Alexandria, VA 22314.

(e) Requirements for coal at locations other than as identified in this §101-26.602-4 may be obtained by submitting requests directly to the Defense Fuel Supply Center, if centralized procurement is desired.

(f) Each participating agency may elect to collect coal samples, for analysis purposes, in accordance with the latest edition of the Handbook on Coal Sampling issued by the Department of the Interior, Bureau of Mines. Copies of this Handbook on Coal Sampling may be obtained upon request from: Coal Sampling and Inspection, Division of Mineral Studies, U.S. Bureau of Mines, College Park, Md. 20740.

(g) Coal samples shall be forwarded by the agency to the Bureau of Mines, 4800 Forbes Avenue, Pittsburgh, Pa. 15213. A charge for each sample submitted will be assessed by the Bureau of Mines for performing such analysis, or agencies may enter into an agreement with the Bureau of Mines for services and testing on an annual flat rate basis. Agencies shall furnish the Bureau of Mines laboratory complete billing instructions at the time sam-

ples are submitted. Copies of the results of each analysis will be furnished by the Bureau of Mines to offices responsible for payment for comparison with the analytical limits guaranteed by the contractor. In the event that the sample does not meet the minimum requirements of the analytical limits specified in the contract, the using agency shall compute the amount, if any, to be deducted from the contract price.

[34 FR 19978, Dec. 20, 1969, as amended at 42 FR 58749, Nov. 11, 1977]

§ 101-26.602-5 Procurement of natural gas from the wellhead and other supply sources.

(a) Natural gas requirements shall be satisfied from sources that are most advantageous to the Government in terms of economy, efficiency, and service. A cost/benefit analysis shall be required by the procuring Federal agency if the natural gas procurements at a facility exceed 20,000 mcf annually and the facility can accept interruptible service. If sources other than the local public utility are the most advantageous to the Government, agency requirements may be satisfied through the Defense Logistics Agency (DLA). Arrangements for DLA procurements on behalf of civilian agencies shall be made through GSA. GSA will forward agency requests to DLA after assuring that necessary requirements data are included.

(b) Agency requests for DLA natural gas shall be forwarded to the Public Utilities Division (PPU), Office of Procurement, General Services Administration, 18th and F Streets, NW., Washington, DC 20405. The requests shall include for each facility for which natural gas is required: The name, address, and telephone number of the requesting agency representative; the name, address, and telephone number of the facility representative; the name of the local distribution company; the expected usage (in mcf) at the facility for each month during the next year of service; the expected peak day usage in mcf at the facility; a statement of funds availability; and documentation of the cost analysis performed that justifies the alternative source procurement.

§ 101-26.603

(c) Agency requests for procurements by DLA shall be forwarded to GSA at the time the information specified in § 101-26.602-5(b) becomes available.

(d) Agencies should anticipate that actions required by DLA to establish a natural gas contract will take 5 to 7 months.

[57 FR 21895, May 26, 1992]

§ 101-26.603 Electronic items available from the Defense Logistics Agency.

Executive agencies shall satisfy their requirements for electronic items listed in the Federal Supply Catalog for Civil agencies (FSC group 59, except classes 5940, 5970, 5975, 5977, and 5995) from the Defense Electronic Supply Center (DESC), DLA. Requisitions shall be prepared in accordance with the FEDSTRIP Operating Guide and submitted to DESC, 1507 Wilmington Pike, Dayton, Ohio 45444, using routing identifier code S9E. Items listed in classes 5940, 5970, 5975, 5977, and 5995, unless managed as exceptions by GSA, shall be obtained from the Defense General Supply Center (DGSC), Richmond, Va. 23297. Electronic items may be obtained from local purchase sources when such action is authorized under the provisions of § 101-26.602-2(b). DESC may return requisitions for local purchase under the same conditions governing the return of requisitions by DGSC set forth in § 101-26.602-2(c).

[42 FR 58749, Nov. 11, 1977]

§ 101-26.605 Items other than petroleum products and electronic items available from the Defense Logistics Agency.

Agencies required to use GSA supply sources should also use Defense supply centers (DSC's) as sources of supply for items listed in the Federal Supply Catalog for Civil Agencies, Identification and Management Data List, published by DLA. By agreement with the Defense Logistics Agency, the catalog will contain only those items in Federal supply classification classes which are assigned to them for Government-wide integrated management, or exception items in other classes similarly assigned. A list of DSC's and their corresponding commodity areas along with requisitioning instructions are published in the FEDSTRIP Operating

41 CFR Ch. 101 (7-1-01 Edition)

Guide. As additional items are assigned to managers other than GSA for Government-wide integrated material management, GSA will announce the changes through the Federal Catalog System and GSA's regular supply publications.

[42 FR 58750, Nov. 11, 1977]

§ 101-26.606 Supply support available from the inventory control points of the military departments.

Federal civil agencies may obtain items of supply which are procured and managed by the inventory control points (ICP) of the Army, Navy, and Air Force and are available in the United States, provided that a national stock number has been assigned to the items. A list of ICP's and their corresponding commodity areas is in the FEDSTRIP operating Guide. Agencies should also refer to the FEDSTRIP operating Guide for additional information concerning supply support from the ICP's and for instructions on obtaining items from these sources.

[42 FR 58750, Nov. 11, 1977]

§ 101-26.607 Billings.

Unless other arrangements have been made between the Defense Logistics Agency and the requisitioning activity, billings for sales will be rendered at least monthly on Standard Form 1080, Voucher for Transfers Between Appropriations and/or Funds, supported by a listing of documents including identification of requisitions and related cards reflecting data pertaining to the gross sale, the retail loss allowance, and any credits for adjustments applicable to prior billings. In addition to these charges, an accessorial charge will be made on shipments destined for overseas to cover expenses incident to overseas packing, handling, and transportation. The Defense supply centers shall be provided with a continental U.S. address for payment of bills for overseas shipments.

[42 FR 28750, Nov. 11, 1977]

§ 101-26.607-1 Payments.

Payments are expected to be made within 15 calendar days of receipt of the Standard Form 1080 from the Defense supply centers. Payment shall

Federal Property Management Regulations

§ 101-26.703

not be deferred until receipt of shipment or withheld pending resolution of adjustments.

[42 FR 58750, Nov. 11, 1977]

§ 101-26.607-2 Adjustments.

Requests for billing adjustments should be submitted in accordance with chapter 5 of the GSA Handbook, Discrepancies or Deficiencies in GSA or DOD Shipments, Material, or Billings (FPMR 101-26.8).

[42 FR 58750, Nov. 11, 1977]

§ 101-26.607-3 Emergency requirements.

In cases of public exigency, items available from the Defense Logistics Agency may be procured from other sources as provided in § 1-3.202.

[42 FR 58750, Nov. 11, 1977]

Subpart 101-26.7—Procurement Sources Other Than GSA and the Department of Defense

§ 101-26.700 Scope and applicability of subpart.

This subpart prescribes policy and procedures relating to procurement sources other than those of GSA and the Department of Defense. The provisions of this subpart 101-26.7 are applicable to executive agencies unless otherwise indicated. Other Federal agencies are encouraged to obtain their requirements in the same manner.

[39 FR 20599, June 12, 1974]

§ 101-26.701 Purchase of products and services from the blind and other severely handicapped persons.

(a) Purchases by executive agencies of products produced by workshops of the blind or other severely handicapped persons which are carried in GSA supply distribution facilities must be made as provided in subpart 101-26.3.

(b) Purchases by all Federal agencies of products and services offered for sale by workshops of the blind or other severely handicapped persons which are not carried in GSA supply distribution facilities, and purchases by executive agencies under exceptions set forth in § 101-26.301, must be made in accordance with the Procurement List pub-

lished by the Committee for Purchase of Products and Services of the Blind and Other Severely Handicapped. Products and services offered by the blind shall be given precedence over those offered by other severely handicapped persons. (See § 101-26.702(d) for priority accorded to products manufactured by Federal Prison Industries, Inc.)

(c) Products produced by workshops for the blind or other severely handicapped persons which are available from GSA supply distribution facilities are designated by an asterisk(*) preceding the national stock number in the Procurement List identified in paragraph (b) of this section.

[39 FR 20599, June 12, 1974, as amended at 40 FR 7619, Feb. 21, 1975]

§ 101-26.702 Purchase of products manufactured by the Federal Prison Industries, Inc.

(a) Purchases by executive agencies of prison-made products carried in GSA supply distribution facilities must be made as provided in subpart 101-26.3.

(b) Purchases by all Federal agencies of prison-made products not carried in GSA supply distribution facilities, or supply items procured under exceptions set forth in § 101-26.301, must be made in accordance with the provisions in the Schedule of Products Made in Federal Penal and Correctional Institutions.

(c) Prison-made products which are available from GSA supply distribution facilities are designated by an asterisk (*) preceding the national stock number in the product schedule referred to in paragraph (b) of this section.

(d) Products available from Federal Prison Industries, Inc., shall be accorded priority over products offered for sale by the workshops of the blind and other severely handicapped persons.

[39 FR 20599, June 12, 1974, as amended at 40 FR 7619, Feb. 21, 1975]

§ 101-26.703 Marginally punched continuous forms.

GSA has delegated authority to the U.S. Government Printing Office (GPO) to procure all marginally punched continuous forms for use by Federal agencies except those procured by GSA for stock. Therefore, all Federal agencies

§ 101-26.704

shall submit their requirements for such forms in accordance with the provisions of this §101-26.703.

(a) Except for those marginally punched continuous forms which GSA procures for stock, all requirements for such forms shall be ordered from GPO contracts or other established GPO sources. If an item is available from GSA stock, acquisition shall be from this source.

(b) Requirements for marginally punched continuous forms which are not available from GPO or GSA sources or which exceed the maximum monetary limitations of the GPO contract shall be submitted to GPO for appropriate action. If requirements are less than the minimum orders/shipment limitations of the GPO contract, agencies may procure them directly from commercial sources.

[39 FR 20600, June 12, 1974]

§ 101-26.704 Purchase of nonperishable subsistence (NPS) items.

With the exception of condiment packages in Federal supply classes 8940 and 8950, managed by the Defense Logistics Agency's Defense Personnel Support Center, all nonperishable subsistence items in Federal supply group 89, Subsistence Items, are managed by and available from the Veterans Administration (VA). These items are listed in the Subsistence Catalog, which is available from the Director, Supply Service (134A), Veterans Administration, Washington, DC 20420.

[43 FR 29005, July 5, 1978]

Subpart 101-26.8—Discrepancies or Deficiencies in GSA or DOD Shipments, Material, or Billings

SOURCE: 41 FR 56320, Dec. 28, 1976, unless otherwise noted.

§ 101-26.800 Scope of subpart.

This subpart prescribes a uniform system for reporting discrepancies or deficiencies in material or shipments and processing requests for or documenting adjustments in billings from or directed by GSA or Department of Defense (DOD) activities.

41 CFR Ch. 101 (7-1-01 Edition)

§ 101-26.801 Applicability.

This subpart is applicable to all civilian executive agencies, including their contractors and subcontractors when authorized. DOD activities should follow the applicable DOD or military service/agency regulations in reporting discrepancies or deficiencies in shipments or material, or requesting adjustments in billings from or directed by GSA unless exempted therefrom, in which case the provisions of this §101-26.801 apply.

§ 101-26.802 Exclusions.

The provisions of this regulation are not applicable to shipments and billings related to the stockpile of strategic and critical materials or excess or surplus property; or to billings for services, space, communications, and printing.

§ 101-26.803 Discrepancies or deficiencies in shipments, material, or billings.

§ 101-26.803-1 Reporting discrepancies or deficiencies.

Discrepancies or deficiencies in shipments or material occur in four broad categories: Quality deficiencies, shipping discrepancies, transportation discrepancies, and billing discrepancies. When discrepancies or deficiencies occur, activities shall document them with sufficient information to enable initiation and processing of claims against suppliers and carriers. Procedures for documenting discrepancies or deficiencies are set forth in the GSA publication, Discrepancies or Deficiencies in GSA or DOD Shipments, Material, or Billings, issued by the Federal Supply Service, GSA. Copies of the publication may be obtained by submitting a completed GSA Form 457, FSS Publications Mailing List Application, (referencing mailing list code number ODDH-0001) to the following address: General Services Administration, Centralized Mailing List Service (CMLS-C), 819 Taylor Street, P.O. Box 17077, Fort Worth, TX 76102-0077.

NOTE: Copies of the GSA Form 457 may be obtained by writing the Centralized Mailing List Service.

[55 FR 24086, June 14, 1990]

Federal Property Management Regulations

§ 101-26.803-2

§ 101-26.803-2 Reporting quality deficiencies.

(a) Quality deficiencies are defined as defects or nonconforming conditions which limit or prohibit the item received from fulfilling its intended purpose. Quality deficiencies include deficiencies in design, specification, material, manufacturing, and workmanship. Timely reporting of all quality deficiencies is essential to maintain an acceptable quality level for common-use items. GSA relies on agency reporting of quality deficiencies in order to act to remove the defective items from the supply system as well as to document contractor performance files for use in future procurements.

(b) A product deficiency which may cause death, injury, or severe occupational illness, or directly restrict the mission capabilities of the using organization, is called a "category I" complaint. Quality complaints that do not meet the category I criteria are called "category II" complaints. Standard Form (SF) 368, Quality Deficiency Report, or a message in the format of the Standard Form 368, is used to report quality deficiencies.

(c) Standard Form 368 (including SF's 368 submitted in message formats) are required for all product quality deficiencies that involve material (1) shipped to the user from a GSA distribution center (including shipments made directly to the user from GSA distribution centers as well as "indirect" shipments (shipments with intermediate stops between the GSA distribution center and the ultimate user)), (2) shipped to the user from a DOD depot or another Government activity, as directed by GSA, (3) purchased by GSA for the user and inspected by GSA, or (4) ordered from a GSA Federal Supply Schedule contract which specified source inspection by GSA.

(d) Category I complaints are to be reported to GSA by telephone or telegraphic message within 72 hours of discovery. Category II complaints are to be reported within 15 days after discovery.

(e) Standard Forms 368 (in triplicate) should be sent to the following address: GSA Discrepancy Reports Centers (6 FR-Q), 1500 East Bannister Road, Kan-

sas City, MO 64131-3088. Communications routing indicator: RUEVFXE (unclassified), RULSSAA (classified), Com: (816) 926-7447, FTS: 926-7447, AUTOVON: 465-7447.

In addition, when reporting a category I product quality deficiency condition, an information copy should be sent to the following address: General Services Administration, FSS, Office of Quality and Contract Administration, Quality Assurance Division (FQA), Washington, DC 20406. Communications routing indicator: RUEVFWM (unclassified), RULSSAA (classified), COM: (703) 557-8515, FTS: 557-8515.

(f) For defective items covered by a manufacturer's commercial warranty, activities should initially attempt to resolve all complaints on these items themselves (examples of items with a commercial warranty are vehicles, major appliances such as gas and electric ranges, washing machines, dishwashers, and refrigerators). If the contractor replaces or corrects the deficiency, an SF 368, in triplicate, should be sent to the Discrepancy Reports Center at the above address. The resolution of the case should be clearly stated in the text of the SF 368.

(g) If, however, the contractor refuses to correct, or fails to replace, either a defective item or an aspect of service under the warranty, an SF 368, along with copies of all pertinent correspondence, should be forwarded to the GSA office executing the contract (address will be contained in the pertinent contract/purchase order). An information copy of the SF 368 should also be submitted to the Discrepancy Reports Center at the above address.

(h) For items ordered from a GSA Federal Supply Schedule contract when the inspection is performed by an activity other than GSA or when the items are purchased by GSA for the user but not inspected by GSA, activities should initially attempt to resolve all complaints on these items directly with the contractor. If the contractor refuses to correct, or fails to replace a defective item, an SF 368, along with copies of all correspondence, should be forwarded to the GSA office executing the contract (address will be contained in the pertinent contract/purchase order). An information copy of the SF

§ 101-26.803-3

368 should also be submitted to the Discrepancy Reports Center at the above address.

(i) Information submitted to the Discrepancy Reports Center regarding defective items will be maintained as a quality history file for use in future procurements.

(j) Additional information regarding reporting of quality deficiencies may be obtained by referring to chapter 4 of the GSA publication cited in §101-26.803-1.

[53 FR 26595, July 14, 1988, as amended at 55 FR 24086, June 14, 1990]

§ 101-26.803-3 Reporting of discrepancies in transportation, shipments, material, or billings.

(a) Transportation-type discrepancies shall be processed under the instructions in subpart 101-40.7 when the discrepancies are the fault of the carrier and occur while the shipments are in the possession of:

(1) International ocean or air carriers, regardless of who pays the transportation charges, except when shipment is on a through Government bill of lading (TGBL), or is made through the Defense Transportation System (DTS). Discrepancies in shipments on a TGBL or which occur while in the DTS shall be reported as prescribed in the GSA publication referenced in §101-26.803-1; or

(2) Carriers within the continental United States, when other than GSA or DOD pays the transportation charges.

(b) All other shipping, transportation, or billing discrepancies shall be reported on the forms, and within the time frames, dollar limitations, and according to the procedures prescribed in the GSA publication referenced in §101-26.803-1.

[53 FR 26596, July 14, 1988, as amended at 55 FR 24086, June 14, 1990]

§ 101-26.803-4 Adjustments.

GSA and DOD will adjust billings resulting from over or under charges, or discrepancies or deficiencies in shipments, or material on a bill submitted under the provisions of this subpart 101-26.8 and the GSA publication referenced in §101-26.803-1.

[55 FR 24086, June 14, 1990]

41 CFR Ch. 101 (7-1-01 Edition)

**Subparts 101-26.9—101-26.48
[Reserved]**

Subpart 101-26.49—Illustrations of Forms

§ 101-26.4900 Scope of subpart.

This subpart illustrates forms prescribed or available for use in connection with subject matter covered in other subparts of part 101-26.

[29 FR 14729, Oct. 29, 1964]

§ 101-26.4901 Standard forms.

(a) The Standard forms are illustrated in this section to show their text, format, and arrangement and to provide a ready source of reference. The subsection numbers in this section correspond with the Standard form numbers.

(b) The Standard forms illustrated in this §101-26.4901 may be obtained by submitting a requisition in FEDSTRIP/MILSTRIP format to the GSA regional office providing support to the requesting agency.

[32 FR 15754, Nov. 16, 1967, as amended at 41 FR 34633, Aug. 16, 1976]

§ 101-26.4901-149 Standard Form 149, U.S. Government National Credit Card.

NOTE: The form illustrated in §101-26.4901-149 is filed as part of the original document and does not appear in the FEDERAL REGISTER or the Code of Federal Regulations.

[37 FR 18536, Sept. 13, 1972]

§ 101-26.4902 GSA forms.

(a) The GSA forms are illustrated in this §101-26.4902 to show their text, format, and arrangement and to provide a ready source of reference. The subsection numbers in this section correspond with the GSA form numbers.

(b) Agency field offices may obtain the GSA forms illustrated in this §101-26.4902 by submitting their requirements to their Washington headquarters office which will forward consolidated annual requirements to the General Services Administration (BRO), Washington, DC 20405.

[31 FR 7235, May 18, 1966, as amended at 41 FR 34633, Aug. 16, 1976]

Federal Property Management Regulations

Pt. 101-27

§ 101-26.4902-457 GSA Form 457, FSS Publications Mailing List Application.

NOTE: The form illustrated in §101-26.4902-457 is filed as part of the original document and does not appear in the FEDERAL REGISTER or the Code of Federal Regulations.

[40 FR 31224, July 25, 1975]

§ 101-26.4902-1398 GSA Form 1398: Motor vehicle purchase and inspection label.

NOTE: The form illustrated in §101-26.4902-1398 is filed as part of the original document and does not appear in the FEDERAL REGISTER or the Code of Federal Regulations.

[39 FR 20683, June 13, 1974]

§ 101-26.4902-1424 GSA Form 1424, GSA Supplemental Provisions.

NOTE: The form illustrated in §101-26.4902-1424 is filed as part of the original document and does not appear in the FEDERAL REGISTER or the Code of Federal Regulations.

[44 FR 24060, Apr. 24, 1979]

§ 101-26.4902-1781 GSA Form 1781, Motor Vehicle Requisition—Delivery Order.

NOTE: The form illustrated in §101-26.4902-1781 is filed as part of the original document and does not appear in the FEDERAL REGISTER or the Code of Federal Regulations.

[47 FR 41364, Sept. 20, 1982]

§ 101-26.4902-2891 GSA Form 2891: Instructions to Users of Federal Supply Schedules.

NOTE: The form illustrated in §101-26.4902-2891 is filed as part of the original document and does not appear in the FEDERAL REGISTER or the Code of Federal Regulations.

[43 FR 24533, June 6, 1978]

§ 101-26.4904 Other agency forms.

This section illustrates forms issued by other agencies which are prescribed or available for use in connection with subject matter covered in other subparts of part 101-26. The issuing activity is also identified in the section requiring the use of such forms. The forms are illustrated to show their text, format, and arrangement and to provide a ready source of reference. The subsection numbers in this section

correspond with the applicable agency form numbers.

[34 FR 19979, Dec. 20, 1969]

§ 101-26.4904-416 DD Form 416: Purchase Request for Coal, Coke, or Briquettes.

NOTE: The form illustrated in §101-26.4904-416 is filed as part of the original document and does not appear in the FEDERAL REGISTER or the Code of Federal Regulations.

[40 FR 31224, July 25, 1975]

PART 101-27—INVENTORY MANAGEMENT

Sec.

101-27.000 Scope of part.

Subpart 101-27.1—Stock Replenishment

101-27.101 General.

101-27.102 Economic order quantity principle.

101-27.102-1 Applicability.

101-27.102-2 Guidelines.

101-27.102-3 Limitations on use.

101-27.103 Acquisition of excess property.

Subpart 101-27.2—Management of Shelf-Life Materials

101-27.201 Scope of subpart.

101-27.202 Applicability.

101-27.203 Program objectives.

101-27.204 Types of shelf-life items.

101-27.205 Shelf-life codes.

101-27.206 Procurement of shelf-life materials.

101-27.206-1 General considerations.

101-27.206-2 Identification and shipping requirements.

101-27.206-3 Packaging.

101-27.207 Control and inspection.

101-27.207-1 Agency controls.

101-27.207-2 Inspection.

101-27.207-3 Marking material to show extended shelf life.

101-27.208 Inventory analyses.

101-27.209 Utilization and distribution of shelf-life items.

101-27.209-1 GSA stock items.

101-27.209-2 Items to be reported as excess.

101-27.209-3 Disposition of unneeded property.

Subpart 101-27.3—Maximizing Use of Inventories

101-27.300 Scope.

101-27.301 [Reserved]

101-27.302 Applicability.

101-27.303 Reducing long supply.

101-27.303-1 Cancellation or transfer.

§ 101-27.000

- 101-27.303-2 Redistribution.
- 101-27.304 Criteria for economic retention limits.
- 101-27.304-1 Establishment of economic retention limit.
- 101-27.304-2 Factors affecting the economic retention limit.
- 101-27.305 Disposition of long supply.

Subpart 101-27.4—Elimination of Items From Inventory

- 101-27.400 Scope of subpart.
- 101-27.401 [Reserved]
- 101-27.402 Applicability.
- 101-27.403 General.
- 101-27.404 Review of items.
- 101-27.405 Criteria for elimination.
- 101-27.406 Disposition of stock.

Subpart 101-27.5—Return of GSA Stock Items

- 101-27.500 Scope and applicability of subpart.
- 101-27.501 Eligibility for return.
- 101-27.502 Criteria for return.
- 101-27.503 Allowable credit.
- 101-27.504 Notice to GSA.
- 101-27.505 Notice to activity.
- 101-27.506 Determination of acceptability for credit.
- 101-27.507 Transportation and other costs.

AUTHORITY: Sec. 205(c), 63 Stat. 390; 40 U.S.C. 486(c).

§ 101-27.000 Scope of part.

This part provides policies, principles, and guidelines to be used in the management of Government-owned inventories of personal property.

[29 FR 15997, Dec. 1, 1964]

Subpart 101-27.1—Stock Replenishment

§ 101-27.101 General.

Each agency shall establish and maintain such control of personal property inventories as will assure that the total cost involved will be kept to the minimum consistent with program needs. For purposes of stock replenishment, inventories may be considered to be composed of active inventory which is that portion carried to satisfy average expected demand, and safety stock which is that portion carried for protection against stock depletion occurring when demand exceeds average expected demand, or when leadtime is greater than anticipated.

41 CFR Ch. 101 (7-1-01 Edition)

(a) In establishing active inventory levels, consideration shall be given to the average demand of individual items, space availability, procurement costs, inventory carrying costs, purchase prices, quantity discounts, transportation costs, other pertinent costs, and statutory and budgetary limitations.

(b) In establishing safety stock levels, consideration shall be given to demand and leadtime fluctuations, essentiality of items, and the additional costs required to achieve additional availability.

[29 FR 15997, Dec. 1, 1964]

§ 101-27.102 Economic order quantity principle.

The economic order quantity (EOQ) principle is a means for achieving economical inventory management. Application of the EOQ principle reduces total variable costs of procurement and possession to a minimum.

[41 FR 3858, Jan. 27, 1976]

§ 101-27.102-1 Applicability.

All executive agencies, except the Department of Defense, within the United States, excluding Alaska and Hawaii, shall replenish inventories of stock items having recurring demands, except items held at points of final use, in accordance with the economic order quantity (EOQ) principle.

[29 FR 15997, Dec. 1, 1964]

§ 101-27.102-2 Guidelines.

Guidelines for implementing the EOQ principle of stock replenishment are in the GSA Handbook, The Economic Order Quantity Principle and Applications, issued by the Federal Supply Service, GSA. The handbook is identified under national stock number 7610-00-543-6765 in the GSA Supply Catalog, and copies may be obtained by agencies in the same manner as other items in that catalog. The public may purchase the handbook from the Superintendent of Documents, U.S. Government Printing Office, Washington, DC 20402.

[41 FR 3858, Jan. 27, 1976]

Federal Property Management Regulations

§ 101-27.203

§ 101-27.102-3 Limitations on use.

(a) When there are no limiting factors which preclude its application, such as space or budgetary limitations, the basic EOQ techniques shall be used.

(b) When a space, personnel, or budgetary limitation precludes application of the basic EOQ technique, a modification of the technique may be made provided the modification produces:

(1) The fewest possible replenishments for a given level of inventory investment; or

(2) The lowest possible level of inventory investment for a given number of replenishments.

(c) When quantity purchase discounts or volume transportation rates will produce savings greater than the increased variable costs involved in procurement and possession, the economic purchase quantity (EPQ) principle shall be used as described in the GSA Handbook. The Economic Order Quantity Principle and Applications.

[29 FR 15997, Dec. 1, 1964, as amended at 31 FR 9541, July 14, 1966; 41 FR 3858, Jan. 27, 1976]

§ 101-27.103 Acquisition of excess property.

Except for inventories eligible for return to GSA for credit pursuant to the provisions of § 101-27.501 and for inventories for which an economic retention limit has been established in accordance with the provisions of subpart 101-27.3 of this part, inventory levels may be adjusted upward when items of stock are to be acquired from excess sources. Such adjustments should be tempered by caution and arrived at after careful consideration. Generally, acquisitions of items for inventory from excess sources shall not exceed a 2-year supply except when:

(a) A greater quantity is needed to meet known requirements for an authorized planned program.

(b) The item is not available without special manufacture and a predictable requirement exists.

(c) Administrative determination has been made that in application of the EOQ principle of stock replenishment within an agency an inventory level in excess of 2 years is appropriate for low dollar-volume items.

(d) The items are being transferred into authorized stock funds for resale to other Government agencies.

[34 FR 200, Jan. 7, 1969, as amended at 41 FR 3858, Jan. 27, 1976]

Subpart 101-27.2—Management of Shelf-Life Materials

§ 101-27.201 Scope of subpart.

This subpart provides for the identification, designation of useful life, and establishment of controls for shelf-life items to minimize loss and insure maximum use prior to deterioration. A shelf-life item is any item possessing deteriorative or unstable characteristics to the degree that a storage period must be assigned to assure the issuance of material that will perform satisfactorily in service.

[32 FR 6493, Apr. 27, 1967]

§ 101-27.202 Applicability.

This subpart 101-27.2 is applicable to all executive agencies except the Department of Defense. The principles and objectives prescribed in this subpart are in consonance with those adopted by the Department of Defense in the establishment of shelf-life procedures for use by military activities.

[32 FR 6493, Apr. 27, 1967]

§ 101-27.203 Program objectives.

In order to assure maximum use of shelf-life items, each executive agency shall:

(a) Identify shelf-life items, including any new items to be placed in inventory, which have a limited shelf-life period.

(b) Establish the shelf-life period of such items and procedures for controlling their procurement, storage, and issue.

(c) Inspect or test certain shelf-life items prior to deterioration to determine if the shelf-life period can be extended.

(d) Conduct inventory management analyses to determine if shelf-life stocks are expected to be utilized prior to the expiration of the original or any extended shelf-life period, and, if not, arrange for transfer of such stock in

§ 101-27.204

sufficient time to permit usage prior to deterioration.

(e) Make available for Government-wide distribution, through excess property channels, any stocks which cannot be utilized through normal supply channels.

[32 FR 6493, Apr. 27, 1967]

§ 101-27.204 Types of shelf-life items.

Shelf-life items are classified as non-extendable (Type I) and extendable (Type II). Type I items have a definite storage life after which the item or material is considered to be no longer usable for its primary function and should be discarded. Type II items are those for which successive reinspection dates can be established when the items have a continued usability as determined by examination based upon criteria that have been agreed upon. Examples of Type I items are drugs and medicines with certain characteristics. Examples of Type II items are paint and ink.

[40 FR 59595, Dec. 29, 1975]

§ 101-27.205 Shelf-life codes.

Shelf-life items shall be identified by use of a one-digit code to provide for uniform coding of shelf-life materials by all agencies.

(a) The code designators for shelf-life periods of up to 60 months are as follows:

Shelf-life period (months)	Type I item code	Type II item code
1	A
2	B
3	C	1
4	D
5	E
6	F	2
9	G	3
12	H	4
15	J
18	K	5
21	L
24	M	6
27	N
30	P
36	Q	7
48	R	8
60	S	9

(b) Code designator 0 is used to identify items not included in a shelf-life program.

(c) Code designator X shall be used to identify critical end-use items, military essential items, and medical items

41 CFR Ch. 101 (7-1-01 Edition)

with a shelf life greater than 60 months. Agencies shall establish controls for such materials to prevent issuance of any unserviceable items.

(d) Agencies may also establish controls for materials with a shelf life greater than 60 months that are not identified in paragraph (c) of this section. Such controls should be established only when they are necessary for effective management of the items.

[40 FR 59595, Dec. 29, 1975]

§ 101-27.206 Procurement of shelf-life materials.

§ 101-27.206-1 General considerations.

In determining requirements for shelf-life items, the following elements should be taken into consideration:

(a) Assigned storage time periods; and

(b) Appropriate contracting techniques for the particular item involved, including specification requirements, industry practices, and storage and delivery procedures.

[40 FR 59595, Dec. 29, 1975]

§ 101-27.206-2 Identification and shipping requirements.

Manufacturers shall, whenever practicable, be required to mark the unit or container with the month and year of manufacture or production and the batch number on all shelf-life items (60 months or less) procured from other than GSA sources. Whenever practical, the supplier shall be required to ship or deliver material within a given number of months from the date of manufacture or production. These "age on delivery" requirements should not be imposed in such a manner as to unduly restrict competition at any trade level. The following guidelines are suggested as appropriate for most shelf-life items:

Shelf-life period	Age on delivery
25 mos. or more	6 mos.
19 to 24 mos	4 mos.
13 to 18 mos	3 mos.
7 to 12 mos	2 mos.
6 mos. or less	1 mo. or less.

[40 FR 59595, Dec. 29, 1975]

Federal Property Management Regulations

§ 101-27.208

§ 101-27.206-3 Packaging.

To the extent feasible and economical, shelf-life material shall be packaged in such a way as to provide for minimum deterioration.

[40 FR 59595, Dec. 29, 1975]

§ 101-27.207 Control and inspection.

§ 101-27.207-1 Agency controls.

Agencies shall establish the necessary controls to identify shelf-life items on their stock records (and in other appropriate elements of their supply system), and shall determine the appropriate shelf life for other than GSA managed items. Shelf-life items shall be stored in such a way as to ensure that the oldest stock on hand is issued first. Agencies shall issue the oldest stock of shelf-life items first except when it is not feasible as in shipments to overseas activities.

[40 FR 59596, Dec. 29, 1975]

§ 101-27.207-2 Inspection.

Type II items remaining in stock immediately before the end of the designated shelf-life period shall be inspected to determine whether the shelf life can be extended, except items having a line item inventory value of \$300 or less, or if the cost of inspection or testing is significant in relation to the value of the item. If the material is found suitable for issue on the date of inspection, the shelf life should be extended for a period equal to 50 percent of the original shelf-life period and the next reinspection date established accordingly. Material should be reinspected before the end of each extended shelf-life period and the shelf life extended again up to 50 percent of the original shelf life as long as the material conforms to the established criteria. Material on which the shelf life has been extended shall not be shipped to overseas activities if the time remaining in the extended shelf-life period is relatively short.

[40 FR 59596, Dec. 29, 1975]

§ 101-27.207-3 Marking material to show extended shelf life.

When the shelf-life period of Type II material (except for critical end-use

items as described below) is extended, only the exterior containers of bulk stocks need be annotated or labeled to indicate the date of inspection and date material is to be reinspected. Individual units of issue not classified as having a critical end-use application are not required to be annotated or labeled as long as controls are established to preclude issuance of unserviceable material to a user. (A critical end-use item is any item which is essential to the preservation of life in emergencies; e.g., parachutes, marine life preservers, and certain drug products, or any item which is essential to the performance of a major system; e.g., aircraft, the failure of which would cause damage to the system or endanger personnel.) At the time of shipment, the date of inspection and date for reinspection shall be affixed by label or marked by other means on each unit of issue of Type II items having a critical end-use application.

[42 FR 61861, Dec. 7, 1977]

§ 101-27.208 Inventory analyses.

(a) An inventory analysis shall be conducted periodically for each Type I item to determine whether the quantity on hand will be used within the established shelf-life period. If the analysis indicates there are quantities which will not be used within the shelf-life period, arrangements shall be made to ensure use of the item(s) within the holding agency or for redistribution to other agencies.

(b) An inventory analysis shall be conducted periodically for each Type II item with a shelf life of 60 months or less to determine whether issue of the quantity on hand is anticipated prior to the expiration of the designated shelf life. This analysis shall be made as follows:

Shelf-life period	Date of analysis
48 to 60 mos	12 to 16 mo. prior to expiration.
36 to 48 mos	8 to 12 mo. prior to expiration.
18 to 36 mos	6 to 8 mo. prior to expiration.
12 to 18 mos	4 to 6 mo. prior to expiration.
6 to 12 mos	3 to 4 mo. prior to expiration.
Up to 6 mos	No analysis required, but special emphasis should be placed on good requirements determination and proper order quantity.

§ 101-27.209

(1) If the analysis indicates that the quantity on hand will not be issued within the shelf-life period and the cost of inspection or testing is not significant in relation to the line item value, the items shall be inspected to determine if the shelf-life period can be extended.

(2) If the analysis indicates that the quantity on hand will be issued within the shelf-life period, inspection is not required. However, such items shall be viewed again during the last month of the shelf-life period to determine whether quantities are sufficient to warrant inspection. The guidelines in § 101-27.207-2 shall be used to determine whether quantities are sufficient to warrant inspection and for extending the shelf-life period.

(3) If an agency does not have an inspection capability and the quantity and value of an indicated overage is sufficiently large to warrant special consideration, arrangements shall be made for qualified inspection or laboratory testing to determine whether the material is suitable for issue.

[40 FR 59596, Dec. 29, 1975]

§ 101-27.209 Utilization and distribution of shelf-life items.

Where it is determined that specified quantities of both Type I and Type II shelf-life items will not be used within the shelf-life period, such quantities shall be utilized or distributed in accordance with this section.

[35 FR 5010, Mar. 24, 1970]

§ 101-27.209-1 GSA stock items.

Shelf-life items that meet the criteria for return under the provisions of subpart 101-27.5 of this part may be offered for return to GSA.

[35 FR 12721, Aug. 11, 1970]

§ 101-27.209-2 Items to be reported as excess.

Shelf-life items which do not meet the criteria in subpart 101-27.5 of this part, which would, if returned to GSA, adversely affect the GSA nationwide stock position, or which are returned to GSA and are determined unsuitable for issue, will be reported as excess

41 CFR Ch. 101 (7-1-01 Edition)

under the provisions of part 101-43 of this chapter.

[35 FR 12721, Aug. 11, 1970]

§ 101-27.209-3 Disposition of unneeded property.

If no transfer is effected and no donation requested, the property shall be assigned for sale, abandonment, or destruction in accordance with part 101-45 of this chapter.

[32 FR 6493, Apr. 27, 1967]

Subpart 101-27.3—Maximizing Use of Inventories

SOURCE: 32 FR 13456, Sept. 26, 1967, unless otherwise noted.

§ 101-27.300 Scope.

This subpart prescribes policy and procedures to assure maximum use of inventories based upon recognized economic limitations.

§ 101-27.301 [Reserved]

§ 101-27.302 Applicability.

The provisions of this subpart are applicable to all civil executive agencies.

§ 101-27.303 Reducing long supply.

Through effective interagency matching of material and requirements before the material becomes excess, unnecessary procurements and investment losses can be reduced. Timely action is required to reduce inventories to their normal stock levels by curtailing procurement and by utilizing and redistributing long supply. (The term *long supply* means the increment of inventory of an item that exceeds the stock level criteria established for that item by the inventory manager, but excludes quantities to be declared excess.) In this connection, requirements for agency managed items should be obtained from long supply inventories offered by agencies rather than by procurement from commercial sources. Because supply requirements usually fluctuate over a period of time, a long supply quantity which is 10 percent or less of the total stock of the

Federal Property Management Regulations

§ 101-27.304-1

item is considered marginal and need not be reduced.

[41 FR 3858, Jan. 27, 1976]

§ 101-27.303-1 Cancellation or transfer.

When the long supply of an item, including quantities due in from procurement, is greater than 10 percent of the total stock of that item, the inventory manager, or other appropriate official, shall cancel or curtail any outstanding requisitions or procurements on which award has not been made for such items, and may also cancel contracts for such items (if penalty charges would not be incurred) or transfer the long supply, if economical, to other offices within the agency in accordance with agency utilization procedures. In such cases, acquisition of long supply items shall not be made from other sources such as requirements contracts.

§ 101-27.303-2 Redistribution.

If the long supply of an item remains greater than 10 percent of the total stock of an item despite efforts to cancel or transfer the long supply as provided in § 101-27.303-1, the inventory manager shall offer the long supply to another agency or other agencies in accordance with this § 101-27.303-2. Before offering a long supply to any agency, the inventory manager shall determine whether the item to be offered is a centrally managed item or an agency managed item. A centrally managed item is an item of supply or equipment which forms part of an inventory of an agency performing a mission of storage and distribution to other Government activities; e.g., GSA and DSA. An agency managed item is a procured item that forms a part of a controlled inventory of an agency and its activities for issue internally for its own use. After determining whether the item to be offered is an agency or centrally managed item, the inventory manager shall:

(a) Offer centrally managed items to the agency managing the item for return and credit in accordance with the procedures established by that agency; and

(b) Offer agency managed items to other agencies which manage the same item. Reimbursement shall be arranged

by the agencies effecting the inventory transfer. The responsibility of locating agencies or activities requiring these items shall rest with the agency holding the long supply. However, agencies may receive a list of Government activities using particular national stock numbers by writing to the General Services Administration (FFL), Washington, DC 20406.

[32 FR 13456, Sept. 26, 1967, as amended at 41 FR 3858, Jan. 27, 1976]

§ 101-27.304 Criteria for economic retention limits.

If a long supply continues to exceed 10 percent of the total stock of an item despite efforts to redistribute the long supply as provided in § 101-27.303-2, the inventory manager shall establish an economic retention limit for the item in accordance with the provisions of this § 101-27.304. An economic retention limit is the maximum quantity of an item that can be held in stock without incurring greater costs for carrying the stock than the costs for disposal and resulting loss of investment. The economic retention limit shall be used to determine which portion of the inventory may be economically retained and which portion should be disposed of as excess.

[41 FR 3858, Jan. 27, 1976]

§ 101-27.304-1 Establishment of economic retention limit.

An economic retention limit must be established for inventories so that the Government will not incur any more than the minimum necessary costs to provide stock of an item at the time it is required. Generally, it would be more economical to dispose of stock in excess of the limit and procure stock again at a future time when the need is more proximate rather than incur the cumulative carrying costs.

(a) The agency managing a centrally managed or agency managed item shall establish an economic retention limit so that the total cumulative cost of carrying a stock of the item (including interest on the capital that is tied up in the accumulated carrying costs) will be no greater than the reacquisition cost of the stock (including the procurement or order cost). Consideration

should be given to any significant net return that might be realized from present disposal of the stock. Where no information has been issued, the net return from disposal is assumed to be zero. Guidelines for setting stock retention limits are provided in the following table and explanatory remarks that follow:

Annual carrying costs as a percentage of item reacquisition costs	Economic retention limit in years of supply—net return on disposal as a percentage of item reacquisition costs				
	0	5	10	15	20
10	7¼	6¾	6¼	6	5½
15	5½	5	4¾	4¼	4
20	4¼	4	3¾	3½	3¼
25	3½	3¼	3	3	2¾
30	3	2¾	2¾	2½	2¼
35	2¾	2½	2¼	2¼	2
40	2½	2¼	2	2	1¾

NOTE: The entries in the tables were calculated by determining how long an item must be carried in inventory before the total cumulative carrying costs (including interest on the additional funds that would be tied up in the accumulated annual carrying costs) would exceed the acquisition costs of the stock, at that time (reacquisition costs). For example, assuming no net return from disposal, the accumulated carrying costs computed at the rate of 25 percent per year on the reacquisition cost of the stock and compounded annually at 10 percent (GSA's recommended rate of interest on Government investments) would be:

Years	Compounded carrying costs as a percentage of reacquisition	Accumulated costs as a percentage of reacquisition costs
1	27.5	27.5
2	30.3	57.8
3	33.3	91.1
4	36.6	127.7
5	40.3	168.0
6	44.3	212.3

At 25 percent a year, accumulated carrying costs would be equivalent to the reacquisition costs after 3½ years. Three and one-half years is, therefore, the economic retention limit for items with a 25 percent annual carrying cost rate. Where an activity has not yet established an estimate of its carrying cost, an annual rate of 10 percent may be used as an interim rate thereby resulting in an economic retention limit of 7¼ years when the net return on disposal is zero. The elements of carrying (holding) cost are given in the GSA Handbook, The Economic Order Quantity Principle and Applications. The handbook is listed in the GSA Supply Catalog and may be ordered in the same manner as other items in the catalog.

(b) The economic retention limit at a user stocking activity can best be determined by the item manager (for centrally managed or agency managed items) on the basis of overall Government requirements and planned procurement. Since stocks in long supply at a user stocking activity are less likely to find utilization outlets, the retention limit at these activities should be relatively small. Generally the economic retention limit at a user stocking activity should be computed in the same manner as in paragraph (a) of this section and then reduced by 70 percent.

[39 FR 27902, Aug. 2, 1974]

§ 101-27.304-2 Factors affecting the economic retention limit.

(a) The economic retention limit may be increased where:

(1) The item is of special manufacture and relates to an end item of equipment which is expected to be in use beyond the economic retention time limit; or

(2) Costs incident to holding an additional quantity are insignificant and obsolescence and deterioration of an item are unlikely.

(b) The economic retention limit should be reduced under the following conditions:

(1) The related end item of equipment is being phased out or an interchangeable item is available; or

(2) The item has limited storage life, is likely to become obsolete, or the age and condition of the item does not justify the full retention limit.

§ 101-27.305 Disposition of long supply.

Where efforts to reduce the inventory below the economic retention limit have been unsuccessful, appropriate disposition should be effected in accordance with subpart 101-43.3 of this chapter. Any remaining inventory which is within the economic retention limit shall be retained. However, the item shall be reviewed at least annually and efforts made to reduce the long supply inventory in accordance with § 101-27.303.

Subpart 101-27.4—Elimination of Items From Inventory

SOURCE: 32 FR 12401, Aug. 25, 1967, and 32 FR 12721, Sept. 2, 1967, unless otherwise noted.

§ 101-27.400 Scope of subpart.

This subpart establishes policy and procedures designed to assure that items which can be obtained more economically from readily available sources, Government or commercial, are eliminated from inventory. For items which are not readily available from Government or commercial sources or are being held in inventory for a one time construction project, this subpart shall be applied to the extent feasible by the activity managing or controlling such inventories.

§ 101-27.401 [Reserved]

§ 101-27.402 Applicability.

The provisions of this subpart are applicable to all executive agencies in connection with inventory items maintained at stocking activities other than Government wholesale supply sources.

§ 101-27.403 General.

By eliminating inactive items and slow-moving items which are readily available, when needed, from Government wholesale supply activities or from commercial sources, the costs to the Government in inventory investment and for maintaining the items in inventory can be eliminated. An "inactive item" is an item for which no current or future requirements are recognized by previous users and the item manager. A "slow-moving item" is an item for which there are current or future requirements, but the frequency and quantity of such requirements do not make it economical to stock them in lieu of obtaining requirements from other sources when needed. However, "standby or reserve items" are not to be eliminated from inventories. A "standby or reserve item" is an item for which a reserve stock is held so that the items will be available immediately to meet emergencies for which there is insufficient time to procure or requisition the items without endan-

gering life or causing substantial financial loss to the Government.

[41 FR 3859, Jan. 27, 1976]

§ 101-27.404 Review of items.

Except for standby or reserve stocks, items in inventory shall be reviewed periodically (at least annually) to identify those which are inactive and slow-moving. This review may be conducted coincidentally with the normal replenishment or long supply reviews. The estimate of current or future requirements for an item shall be based on its recent history of recurring requirements. Standby items shall also be reviewed at appropriate intervals to substantiate their qualification for inclusion in that category.

§ 101-27.405 Criteria for elimination.

Inactive items, items which no longer qualify as standby, and slow-moving items which are readily available, when needed, from Government or commercial sources shall be eliminated from inventory. The determination of a slow-moving item shall be based on a comparison of the costs for continuing to maintain it in stock as opposed to the costs for ordering it from outside sources each time it is requested. This comparison shall also consider any difference in price and transportation costs for each alternative. In the absence of criteria for stockage of an item developed and used by an agency, the desired results will be obtained through application of the following table:

Orders per year under economic order quantity (EOQ)	Minimum number of requests per year to justify continuation in stock
12 and over	24
11	22
10	20
9	18
8	16
7	14
6	12
5	10
4	8

§ 101-27.406

41 CFR Ch. 101 (7-1-01 Edition)

Orders per year under economic order quantity (EOQ)	Minimum number of requests per year to justify continuation in stock
3 and under	7
NOTE: Except for the low dollar infrequently ordered item, which requires a higher minimum, an item should be discontinued from stock if the number of requests for it is less than twice its order frequency under EOQ. For example, an item ordered six times per year under EOQ should have at least 12 requests per year to continue stockage. For 11 requests, it would cost less to order each time it was requested.	
11 orders at \$5 per order	\$55
Under EOQ:	
6 orders at \$5 per order	\$30
Holding cost (equal to ordering cost)	30
Total	60

§ 101-27.406 Disposition of stock.

Stocks of slow-moving items which are not otherwise determined to be eligible for continued stockage shall be eliminated through normal attrition and shall not be replenished. The successive actions indicated in paragraphs (a) through (c) of this section, shall be taken, as necessary, to remove stocks of inactive items from inventory.

(a) Transfer stock to other offices where needed within the agency.

(b) Transfer stock to other agencies as follows:

(1) Centrally managed items to the agency managing the item for credit; or

(2) Agency program items to agencies requiring them.

(c) Dispose of remaining stocks, as excess, after actions taken in paragraphs (a) and (b) of this section, in accordance with subpart 101-43.3.

Subpart 101-27.5—Return of GSA Stock Items

SOURCE: 35 FR 12721, Aug. 11, 1970, unless otherwise noted.

§ 101-27.500 Scope and applicability of subpart.

This subpart sets forth policy and procedures for the return to GSA for credit of items which are in long supply or for which no current or future requirements are anticipated. The provisions of this subpart 101-27.5 are applicable to all executive agencies. Federal agencies other than executive

agencies may participate in this program and are encouraged to do so.

§ 101-27.501 Eligibility for return.

GSA stock items for which no current or future agency requirements are anticipated are eligible for return to GSA for credit. Despite eligibility for return to GSA, consideration should be given to the transportation costs involved as related to the value of the items, and, where excessive, such items shall not be reported to GSA.

§ 101-27.502 Criteria for return.

Any GSA stock item to be returned to GSA by an agency which has no current or future requirements for that item shall meet the following conditions:

(a) The minimum dollar value per line item, based on the current GSA selling price, shall be:

(1) \$130 for hand tools, FSG 51, and measuring tools, FSG 52; and

(2) \$450 for items in all other Federal supply groups and classes except for tires and tubes, FSC 2610; tool kits, FSC 5180; laboratory supplies, FSCs 6630 and 6640; Standard forms, FSC 7540; paints, dopes, varnishes, and related products, FSC 8010; preservatives and sealing compounds, FSC 8030; adhesives, FSC 8040; boxes, cartons, and crates, FSC 8115; and subsistence items, FSG 89, which are not returnable and shall be considered excess, and shall be processed in accordance with part 101-43 of this chapter.

(b) The minimum remaining shelf life of this material shall be 12 months at the time of receipt by GSA.

(c) The material shall not be a terminal or discontinued item.

(d) The material shall be in either condition code A or condition code E.

[35 FR 12721, Aug. 11, 1970, as amended at 44 FR 39393, July 6, 1979; 56 FR 11939, Mar. 21, 1991]

§ 101-27.503 Allowable credit.

Allowable credit for activities returning material that is accepted by GSA will be reflected in billings by GSA and will be commensurate with the condition of the material received.

(a) Credit will be granted at the rate of 80 percent of the current GSA selling price after acceptance by GSA for new,

Federal Property Management Regulations

Pt. 101-28

used, repaired, or reconditioned material which is serviceable and issuable to all agencies without limitation or restriction (condition code A).

(b) Credit will be granted at the rate of 60 percent of the current GSA selling price for items which involve limited expenses or effort to restore to serviceable condition, and which is accomplished in the storage activity where the stock is located (e.g., a deficiency in packing or packaging which restricts the issue or requires repacking or repackaging (condition code E)).

(c) No credit will be given for material returned to GSA which does not meet the above criteria or which was returned to GSA without prior approval.

[56 FR 11939, Mar. 21, 1991]

§ 101-27.504 Notice to GSA.

When an activity elects to offer material to GSA for credit, the activity shall submit offers in accordance with chapter 4 of the FEDSTRIP Operating Guide or chapter 9 of MILSTRIP (DoD 4000.25-1-M).

[56 FR 11939, Mar. 21, 1991]

§ 101-27.505 Notice to activity.

GSA will provide notice to the offering activity of an acceptance/rejection decision for an offer and verification of material receipt for accepted offers.

(a) Within 20 workdays after receipt of an offer to return material, GSA will notify the offering activity of acceptance or rejection of the offer.

(1) For accepted offers, GSA will inform the offering activity of the GSA material return facility (storage activity) to which the material shall be shipped. Prior to shipment of the material authorized by GSA for return, activities shall verify the declared condition. (If the offering activity considers that the transportation costs of sending the material to the GSA material return facility are excessive in relation to the value of the material and withdraws the offers, the GSA region that was designated to receive the offered material shall be notified accordingly.)

(2) For rejected offers, GSA will so inform the activity offering the material and give the reason for nonacceptance.

(b) Upon receipt of material authorized for return by GSA, the offering activity will be provided verification of receipt and a report of any discrepancies. When the discrepant condition is attributable to carrier negligence, subsequent credit allowed by GSA will be reduced by the amount to be paid the agency by the carrier for any damages incurred. A notice of credit will be provided the offering activity through credit entries on the monthly billing statement from the supporting GSA finance center.

(c) When offers of material that have been authorized by GSA for return are withdrawn, offering activities shall report such cancellation to the GSA region that was designated to receive the offered material.

[41 FR 3859, Jan. 27, 1976, as amended at 44 FR 39394, July 6, 1979; 56 FR 11939, Mar. 21, 1991]

§ 101-27.506 Determination of acceptability for credit.

Returned material will be examined by GSA upon receipt to determine acceptability for credit. Returned material which is unacceptable for credit will be deemed to have been declared excess by the returning activity, and will be disposed of by GSA as excess or surplus in the name of the activity, in accordance with part 101-43 of this chapter. The returning activity will be officially notified of the disposal action taken by GSA.

§ 101-27.507 Transportation and other costs.

Transportation costs for the movement of material to GSA and handling costs for preparation and shipment shall be paid by the activity shipping the material to GSA.

PART 101-28—STORAGE AND DISTRIBUTION

Sec.
101-28.000 Scope of part.

Subpart 101-28.1 [Reserved]

Subpart 101-28.2—Interagency Cross-Servicing in Storage Activities

101-28.200 Scope of subpart.
101-28.201 Applicability.

§ 101-28.000

- 101-28.202 GSA/DOD cross-servicing agreement.
- 101-28.202-1 Request for services.
- 101-28.202-2 Cancellation of cross-servicing arrangements.
- 101-28.202-3 Cross-servicing rates.
- 101-28.202-4 Reimbursement for services.
- 101-28.203 Definitions.
- 101-28.203-1 Government storage activity.
- 101-28.203-2—101-28.203-3 [Reserved]
- 101-28.203-4 Contact point.

Subpart 101-28.3—Customer Supply Centers

- 101-28.300 Scope of subpart.
- 101-28.301 Applicability.
- 101-28.302 Mission of customer supply centers.
- 101-28.303 Benefits provided by customer supply centers.
- 101-28.304 Item selection and stockage criteria.
- 101-28.304-1 Types of items.
- 101-28.304-2 Determining items to be stocked.
- 101-28.305 Prices of customer supply center items.
- 101-28.306 Customer supply center (CSC) accounts and related controls.
- 101-28.306-1 Establishment of a CSC account by a customer activity.
- 101-28.306-2 Use of customer supply centers.
- 101-28.306-3 Limitations on use.
- 101-28.306-4 Expiration or cancellation.
- 101-28.306-5 Safeguards.
- 101-28.306-6 Sensitive items.
- 101-28.306-7 Responsibility for operation.

AUTHORITY: Sec. 205(c), 63 Stat. 390; 40 U.S.C. 486(c).

§ 101-28.000 Scope of part.

This part prescribes policy and procedures for the economical and efficient management of warehousing and related activities by executive agencies.

[29 FR 15998, Dec. 1, 1964]

Subpart 101-28.1 [Reserved]

Subpart 101-28.2—Interagency Cross-Servicing in Storage Activities

§ 101-28.200 Scope of subpart.

This subpart prescribes policies and procedures to be followed in the cross-servicing of storage and warehousing services between executive agencies of the Government. It implements the provisions of the cross-servicing agreement between the Department of De-

41 CFR Ch. 101 (7-1-01 Edition)

fense (DOD) and GSA and extends the provisions of the agreement to provide cross-servicing between the civilian agencies of the Government.

[29 FR 15998, Dec. 1, 1964]

§ 101-28.201 Applicability.

(a) The policies and procedures established by this subpart 101-28.2 are primarily applicable to storage activities within the United States. Executive agencies shall make every effort to utilize available Government storage services of other executive agencies to avoid new construction of storage facilities, acquisition of temporary space, and unnecessary transportation of supplies, material, and equipment to distant storage points. Whenever feasible, the policies and procedures shall be used to cross-service storage and warehousing requirements in overseas storage activities. Available storage services of executive agencies shall be made available for cross-servicing the requirements of other Federal agencies when requested. Other Federal agencies are encouraged to participate in cross-servicing arrangements.

(b) The provisions of this subpart 101-28.2 do not apply to ocean terminals, Government storage activities financed under industrial funds, activities concerned with the storage and handling of bulk fuels (petroleum products), and storage functions performed by GSA for the Federal Preparedness Agency.

[35 FR 7050, May 16, 1970, as amended at 42 FR 2317, Jan. 11, 1977]

§ 101-28.202 GSA/DOD cross-servicing agreement.

An agreement between GSA and DOD has established procedures to be followed in the cross-servicing of storage and warehousing services between Government agencies. Copies of the agreement, containing a listing of minimum services to be provided, responsibilities of agencies operating storage facilities, responsibilities of requesting agencies, and agency contact points to determine storage availability, may be obtained from the General Services Administration (FFN), Washington, DC 20406.

[42 FR 2317, Jan. 11, 1977]

Federal Property Management Regulations

§ 101-28.203-4

§ 101-28.202-1 Request for services.

Requests for storage and warehousing services shall be in accordance with the procedures set forth in the GSA/DOD cross-servicing agreement. Arrangements incident to the furnishing of services, specific limitations, terms, and conditions shall be agreed to directly by the activities concerned.

[42 FR 2317, Jan. 11, 1977]

§ 101-28.202-2 Cancellation of cross-servicing arrangements.

(a) Accepted requests may be canceled by the requesting agency prior to delivery of supplies, material, and equipment to the storage activity when logistical developments make cancellation necessary or cancellation is in the best interest of the Government. The agency which accepted the request shall be informed of the cancellation in writing as soon as possible.

(b) Cancellation of arrangements in facilities to be inactivated or disposed of by an operating agency may be made as provided for in the GSA/DOD agreement. Also, after supplies, material, and equipment have been received at a storage activity, cancellation may be made when unforeseen emergencies arise which justify such cancellation. Advice of these necessary cancellations shall be in writing to the agency owning the material sufficiently in advance to allow the owning agency the maximum amount of time to make other arrangements for their property.

(c) When a facility in which cross-servicing is being accomplished is to be transferred from an operating agency to another agency, the operating agency shall inform the agency owning the property at least 90 days before the transfer. The agency owning the property shall negotiate with the agency gaining the facility for continued cross-servicing of the property at the facility. The agency gaining the facility shall continue the cross-servicing arrangements unless they are contrary to the best interest of the Government.

[42 FR 2317, Jan. 11, 1977]

§ 101-28.202-3 Cross-servicing rates.

Normally, charges for services rendered will be based upon the standard

rates established by the agency for internal use. However, special rates may be negotiated to cover actual or estimated costs for large, bulk lots of material when the applicable rates appear inequitable, subject to the approval of the appropriate program official for the civilian agency, and the Assistant Secretary of Defense (I and L) when DOD is involved.

[42 FR 2317, Jan. 11, 1977]

§ 101-28.202-4 Reimbursement for services.

Reimbursement for services rendered shall be made promptly after receipt of billing. The frequency for billing and reimbursement shall be established by the activity providing warehousing and storage services; however, billing and reimbursement shall be made not less frequently than quarterly nor more frequently than monthly.

[42 FR 2317, Jan. 11, 1977]

§ 101-28.203 Definitions.

As used in this subpart 101-28.2, the following term shall apply.

[42 FR 2317, Jan. 11, 1977]

§ 101-28.203-1 Government storage activity.

A Government activity or facility utilized for the receipt, storage, and issue of supplies, materials, and equipment, including storage of reserve or excess stocks or intransit storage. The activity may be either Government owned or leased, and it may be either Government operated or contract operated.

[42 FR 2317, Jan. 11, 1977]

§§ 101-28.203-2—101-28.203-3 [Reserved]

§ 101-28.203-4 Contact point.

The point within the headquarters of a military service or civilian agency to which requests should be forwarded. Coordination necessary with various organizational elements within a military service or civilian agency shall be accomplished by the contact point.

[42 FR 2317, Jan. 11, 1977]

Subpart 101-28.3—Customer Supply Centers

SOURCE: 51 FR 13499, Apr. 21, 1986, unless otherwise noted.

§ 101-28.300 Scope of subpart.

This subpart provides policy for the GSA customer supply center program, including policy on item stockage, services provided, and Federal agency participation.

§ 101-28.301 Applicability.

This subpart is applicable to all activities that are eligible to use customer supply centers. Eligible activities include executive agencies, elements of the legislative and judicial branches of the Government, and cost reimbursable contractors. Customer supply centers are for the use of activities located within the market area of a customer supply center as determined by GSA.

§ 101-28.302 Mission of customer supply centers.

Customer supply centers are retail supply distribution outlets established by GSA to provide efficient, economical support of frequently needed common-use expendable items for the accomplishment of customer agency missions.

§ 101-28.303 Benefits provided by customer supply centers.

The customer supply centers (CSCs) provide the following:

(a) Overall savings to the Federal Government through volume purchases.

(b) Quick and easy catalog item selection and simplified order placement by telephone, mail, electronic mail, or customer walk-in for urgent agency requirements.

(c) Next business day shipment to the customer for most orders.

(d) Same day pick up of emergency walk-in and telephone orders.

(e) Immediate stock availability information for all telephone and walk-in orders.

(f) Extensive inventory designed to meet the needs of customer agencies within the geographic area served by each CSC.

(g) A detailed catalog which lists the items stocked and procedures for use of the CSC.

(h) Automated biweekly billings (consistent with DOD MILSBILLS).

(i) Other services as approved by the GSA Regional Administrator.

§ 101-28.304 Item selection and stockage criteria.

§ 101-28.304-1 Types of items.

Items stocked in customer supply centers are based on customer agency requirements for common use expendable items. In addition to administrative type items commonly used in Government offices, janitorial supplies, handtools, and other industrial-type items are stocked when required to meet the mission-related needs of the activities supported by the CSC.

§ 101-28.304-2 Determining items to be stocked.

(a) Each CSC will stock administrative items normally required by Federal agencies for day-to-day operations. In addition to those items, each CSC will stock additional items as determined by the requirements of the activities within the geographic area it serves.

(b) Regional FSS offices will canvass customer agencies periodically to identify items for which there is an official need within their support area.

(c) Customer agencies may request that specific items be stocked by their support CSC. The requests must be submitted in writing to the appropriate-FSS Bureau Director and must be signed by a customer agency official at a level of responsibility (division director or higher) acceptable to the GSA Regional Administrator. All requests must indicate the expected monthly usage of the item requested. Each request will be evaluated and the submitting activity notified of the results of the evaluation.

§ 101-28.305 Prices of customer supply center items.

The selling price of a CSC item is an average price which is calculated automatically by the CSC computer at the time the item is ordered. Items stocked in CSCs that are obtained from GSA

Federal Property Management Regulations

§ 101-28.306-3

wholesale supply distribution facilities are input into the computer at the price in effect at the time of shipment from the facilities (this price is normally the price shown in the GSA Supply Catalog). Items stocked in CSCs that are not available from GSA wholesale supply distribution facilities but which are obtained from other Government supply sources or commercial sources are input into the computer at the invoice cost. Due to cost averaging, item prices listed in the CSC catalog may differ somewhat from the sale price for a particular transaction.

§ 101-28.306 Customer supply center (CSC) accounts and related controls.

§ 101-28.306-1 Establishment of a CSC account by a customer activity.

(a) Eligible agencies should contact the GSA Regional Federal Supply Service Bureau to obtain full information on the use of the CSC for their locale. FSS Bureau personnel will provide assistance to agencies in the establishment of the CSC account, brief personnel on the use of the CSC to meet local, retail supply requirements, and provide copies of the CSC catalog.

(b) An appropriate level management official (division director or higher) authorized to obligate agency funds must sign the GSA Form 3525, Application for Customer Supply Services, requesting establishment of the CSC account for the activity.

§ 101-28.306-2 Use of customer supply centers.

(a) Orders are received by the CSC via phone, mail, electronic mail, or in person on a walk-in basis for urgent agency requirements. All use of the CSC is based upon the customer access code assigned at the time of establishment of the activity account. The customer access code determines the ship-to point for orders placed with the CSC. The ship-to point cannot be changed, once established, except by the submission of a written request signed by an appropriate agency official.

(b) All orders placed with the CSC, except emergency pickup orders, described in § 101-28.306-1(c), will be shipped to the activity placing the order via mail or small parcel carrier

not later than the end of the next business day.

(c) Walk-in orders for urgent requirements are accepted and filled immediately provided the individual placing the order has proper identification. Telephone orders placed in the morning may be picked up in the afternoon of the same day provided that the individual picking up the order possesses proper identification and the order ticket number provided by the CSC personnel at the time the order is placed.

§ 101-28.306-3 Limitations on use.

(a) Agencies shall establish internal controls to ensure that the use of the CSC account by the agency or other authorized activities is limited to the purchase of items for official Government use. The controls shall include written instructions that contain a statement prohibiting the use of the CSC account in acquiring items for other than Government use. When an agency makes a purchase of more than \$500 per line item from a GSA customer supply center which is other than a similar lowest priced item available from a multiple-award schedule, GSA will assume that a justification has been prepared and made a part of the buying agency's purchase file. Availability of products, regardless of the total amount of the line item price, does not relieve an agency of the responsibility to select the lowest priced item commensurate with needs of the agency.

(b) Office supplies needed by Members of Congress and the Delegate of the District of Columbia for use in their offices in the House or Senate Office Buildings should be obtained from the Senate and Houses Representatives supply rooms, as appropriate. Members of Congress, except for the Delegate of the District of Columbia, should limit their use of the CSCs to those located outside of the District of Columbia. The Delegate of the District of Columbia may obtain office supplies for the use of his or her district offices from the CSC serving the District of Columbia.

§ 101-28.306-4

41 CFR Ch. 101 (7-1-01 Edition)

§ 101-28.306-4 Expiration or cancellation.

(a) CSC accounts established for Federal agencies or members of the Federal judiciary are valid for an indefinite period of time unless canceled by the Commissioner, FSS, GSA, or by a GSA Regional Administrator.

(b) CSC accounts established for authorized contractors or Members of Congress will contain an expiration date reflecting the termination date of the contract or term of office. New accounts will be established for reinstated contractors or reelected Members of Congress upon submission of a new application.

(c) Any CSC customer may request cancellation of his/her account when no longer required or whenever there is cause to believe that the customer access code has been compromised. Agencies shall keep GSA advised of any changes in organization or accounting structures that might have an impact on their CSC accounts.

(d) The Commissioner FSS, GSA, may periodically direct a nationwide purge of all CSC accounts to cancel those that are duplicates, not needed, or for which the customer access code has been compromised. Selective account cancellations may be directed by the GSA Regional Administrator in coordination with FSS Central Office. Under the procedures of a nationwide purge, CSC accounts become invalid as of a specific date established by the Commissioner, FSS, GSA, or by a Regional Administrator, and new CSC accounts are established upon receipt of new applications.

§ 101-28.306-5 Safeguards.

Agencies shall establish internal controls to ensure that the customer access codes assigned for their accounts are properly protected. It is by use of these access codes that orders are accepted by the CSC and these codes determine the ship-to points for all orders filled by the CSC with the exception of orders picked up at the CSC by the customer. GSA will not change the ship-to location associated with the customer access code except upon receipt of a written request to do so, signed by a duly authorized official of the customer activity.

§ 101-28.306-6 Sensitive items.

Many items stocked by the CSCs may be considered sensitive based upon standard criteria factors such as propensity for personal use, the potential for embarrassment of GSA and customer agencies, the level of customer complaints, and control as an accountable item of personal property. Each customer activity shall take all appropriate measures necessary to ensure that all items are properly controlled within its activity and are purchased solely for official Government use.

§ 101-28.306-7 Responsibility for operation.

The GSA Regional Administrator is responsible for the operation of any CSCs located within his or her region.

PART 101-29—FEDERAL PRODUCT DESCRIPTIONS

Sec.

101-29.000 Scope of part.

Subpart 101-29.1—General

101-29.101 Federal product descriptions.
101-29.102 Use of metric system of measurement in Federal product descriptions.

Subpart 101-29.2—Definitions

101-29.201 Specification.
101-29.202 Standard.
101-29.203 Federal specification.
101-29.204 Interim Federal specification.
101-29.205 Federal standard.
101-29.206 Interim Federal standard.
101-29.207 Qualified products list (QPL).
101-29.208 Commercial item description (CID).
101-29.209 Purchase description.
101-29.210 Product.
101-29.211 Product description.
101-29.212 Tailoring.
101-29.213 Commercial product.
101-29.214 Commercial-type product.
101-29.215 Departmental specification or standard.
101-29.216 Department of Defense Index of Specifications and Standards (DODISS).
101-29.217 Military specification or standard.
101-29.218 Voluntary standards.
101-29.219 Index of Federal Specifications, Standards and Commercial Item Descriptions.
101-29.220 Market research and analysis.

Federal Property Management Regulations

§ 101-29.201

101-29.221 Federal Specifications, Standards and Commercial Item Description Program (Federal Standardization Program).

Subpart 101-29.3—Responsibilities

101-29.301 General Services Administration.
101-29.301-1 Policies and procedures.
101-29.301-2 Federal Standardization Handbook.
101-29.301-3 Availability of Federal product descriptions.
101-29.301-4 Periodic review of Federal product descriptions.
101-29.302 Other Federal agencies.
101-29.303 All Federal executive agencies.

Subpart 101-29.4—Mandatory Use of Federal Product Descriptions

101-29.401 Federal product descriptions listed in the GSA Index of Federal Specifications, Standards and Commercial Item Descriptions.
101-29.402 Exceptions to mandatory use of Federal product descriptions.
101-29.403 Federal product description exceptions and tailoring.
101-29.403-1 Authorization of exceptions.
101-29.403-2 Agency responsibility relative to exceptions to Federal product descriptions.
101-29.403-3 Tailoring of Federal product descriptions.

Subpart 101-29.5—Use of and Optional Use of Federal Product Descriptions and Agency Product Descriptions

101-29.501 Optional use of interim Federal specifications.
101-29.502 Use of Federal specifications and interim Federal specifications in Federal construction contracts.
101-29.503 Agency product descriptions.

AUTHORITY: Sec. 205(c), 63 Stat. 390; 40 U.S.C. 486(c).

SOURCE: 48 FR 25196, June 6, 1983, unless otherwise noted.

§ 101-29.000 Scope of part.

This part sets forth the policy and procedures for managing and using Federal product descriptions.

Subpart 101-29.1—General

§ 101-29.101 Federal product descriptions.

Federal and interim Federal specifications, their associated Federal qualified products lists (QPL's), Federal and interim Federal standards and

Commercial item descriptions (CID's) are referred to collectively as Federal product descriptions. They are developed by GSA or other Federal agencies under the Assigned Agency Plan described in the "Federal Standardization Handbook" issued by the Assistant Administrator for Federal Supply and Services (FSS). Product descriptions are coordinated with other Federal agencies having technical, statutory, or regulatory interest in the commodity or other subject matter covered. Generally, before they are issued, Federal product descriptions are reviewed by technical societies, individual industrial producers, and organizations representing industrial producers and consumers.

§ 101-29.102 Use of metric system of measurement in Federal product descriptions.

In accordance with Public Law 94-168, 15 U.S.C. 205b, the Administrator of General Services shall develop procedures and plan for the increasing use of metric products by requiring Federal agencies to:

(a) Maintain close liaison with other Federal agencies, State and local governments, and the private sector on metric matters, and

(b) Review, prepare, and revise Federal standardization documents to eliminate barriers to the procurement of metric goods and services. These actions will occur during the overage document review or when the agency is informed by the private sector that metric products can be produced in a specific Federal supply classification class.

[49 FR 2774, Jan. 23, 1984]

Subpart 101-29.2—Definitions

§ 101-29.201 Specification.

A *specification* is a document, prepared specifically to support acquisition that clearly and accurately describes the essential technical requirements for purchased material. Procedures necessary to determine whether these requirements have been met are also included.

§ 101-29.202

§ 101-29.202 Standard.

A *standard* is a document that establishes engineering and technical requirements for items, processes, procedures, practices, and methods that have been adopted as customary. Standards may also establish requirements for selection, application, and design criteria so as to achieve the highest practical degree of uniformity in materials or products, or interchangeability of parts used within or on those products.

§ 101-29.203 Federal specification.

A *Federal specification* is a specification, issued in the Federal series, that is mandatory for use by all Federal agencies. These documents are issued or controlled by the General Services Administration and are listed in the GSA "Index of Federal Specifications, Standards and Commercial Item Descriptions."

§ 101-29.204 Interim Federal specification.

An *interim Federal specification* is a potential Federal specification issued in temporary form for optional use by all Federal agencies. Interim amendments to Federal Specifications and amendments to interim Federal specifications are included in this definition. These documents are issued or controlled by the General Services Administration and are listed in the GSA "Index of Federal Specifications, Standards and Commercial Item Descriptions."

§ 101-29.205 Federal standard.

A *Federal standard* is a standard, issued in the Federal series, that is mandatory for use by all Federal agencies. These documents are issued or controlled by the General Services Administration and are listed in the GSA "Index of Federal Specifications, Standards and Commercial Item Descriptions."

§ 101-29.206 Interim Federal standard.

An *interim Federal standard* is a potential Federal standard issued in temporary form for optional use by all Federal agencies. These documents are issued or controlled by the General

41 CFR Ch. 101 (7-1-01 Edition)

Services Administration, primarily for use in the telecommunication functional area.

§ 101-29.207 Qualified products list (QPL).

A *qualified products list* is a list of products that have met the qualification requirements stated in the applicable specification, including appropriate product identification and test or qualification reference number, with the name and plant address of the manufacturer and distributor, as applicable. Documents that contain QPL requirements are listed in the GSA "Index of Federal Specifications, Standards and Commercial Item Descriptions."

§ 101-29.208 Commercial item description (CID).

A *commercial item description* is an indexed, simplified product description that describes by function or performance characteristics of available, acceptable commercial products that will satisfy the Government's needs. These documents are issued or controlled by the General Services Administration and are listed in the GSA "Index of Federal Specifications, Standards and Commercial Item Descriptions."

§ 101-29.209 Purchase description.

A *purchase description* is any informal product description prepared for one-time use only or for small purchases when issuance of a formal product description is not cost effective.

§ 101-29.210 Product.

The term *product* is any end item, either manufactured or produced, and also includes materials, parts, components, subassemblies, equipment, accessories, attachments, and services.

§ 101-29.211 Product description.

A *product description* is a description of a product for acquisition and management purposes. Product descriptions include specifications, standards, commercial item descriptions, purchase descriptions, and brand-name purchase descriptions.

Federal Property Management Regulations

§ 101-29.221

§ 101-29.212 Tailoring.

Tailoring is a process by which the individual requirements (sections, paragraphs or sentences) or product descriptions are evaluated to determine the extent to which each requirement is most suitable for a specific acquisition and the modification of these requirements, where necessary, to ensure that each document invoked achieves and optimal balance between operational needs and costs.

§ 101-29.213 Commercial product.

A *commercial product* is any item, component, or system available from stock or regular production that is sold in substantial quantities to the general public at established catalog or market prices (for definition of terms, see FPR 1-3.807.1).

§ 101-29.214 Commercial-type product.

A *commercial-type product* is defined as:

(a) Any product similar to the commercial product but modified or altered in compliance with specified Government requirements and, as such is usually sold only to the Government and not through the normal catalog or retail outlets;

(b) Any product similar to a commercial product that is either assembled or manufactured in accordance with specifically stated Government requirements and sold only to the Government and not to the general public; or

(c) A commercial product identified or marked differently than the commercial product normally sold to the general public.

§ 101-29.215 Departmental specification or standard.

A *departmental specification or standard* is a specification or standard prepared by, and of primary interest to, a particular Federal agency, but which may be used by other Federal agencies.

§ 101-29.216 Department of Defense Index of Specifications and Standards (DODISS).

The *Department of Defense Index of Specifications and Standards* is a Department of Defense (DoD) publication of unclassified Federal and military specifications and standards, related stand-

ardization documents, and voluntary standards that are used by DoD.

§ 101-29.217 Military specification or standard.

A *military specification or standard* is a specification or standard issued by the Department of Defense and listed in the DODISS.

§ 101-29.218 Voluntary standards.

Voluntary standards are established generally by private sector bodies and available for use by any person or organization, private or governmental. The term includes what are commonly referred to as "industry standards" as well as "consensus standards," but does not include professional standards of personal conduct, institutional codes of ethics, private standards of individual firms, or standards mandated by law such as those contained in the United States Pharmacopeia as referenced in 21 U.S.C. 351.

§ 101-29.219 Index of Federal Specifications, Standards and Commercial Item Descriptions.

The *Index of Federal Specification, Standards and Commercial Item Descriptions* is a GSA publication that lists Federal specifications, qualified products lists, standards, and commercial item descriptions.

§ 101-29.220 Market research and analysis.

Market research and analysis is a process used to ascertain and analyze the range and quality of available commercial products to determine whether they meet user needs and to identify the market practices of firms engaged in producing, distributing, and supporting the products.

§ 101-29.221 Federal Specifications, Standards and Commercial Item Description Program (Federal Standardization Program).

The *Federal Specifications, Standards and Commercial Item Description Program* is a standardization program developed under authority of the Federal Property and Administrative Services Act of 1949, as amended (63 Stat. 377) in

consonance with the Defense Cataloging and Standardization Act (Sections 2451-2456, title 10, U.S.C. chapter 145), managed by the General Services Administration, for the purpose of coordinating civilian and military standardization functions to avoid unnecessary duplication. Within the program, procedures and controls govern the development, coordination, approval, issuance, indexing, management, and maintenance of product descriptions in the Federal series (Federal specifications, Federal standards, and CID's) that define commercial products and products that have high potential for common Federal agency use.

Subpart 101-29.3—Responsibilities

§ 101-29.301 General Services Administration.

§ 101-29.301-1 Policies and procedures.

The Administrator of General Services is responsible for establishing policies and procedures, in coordination with the other agencies, for the preparation, coordination, approval, issuance, and maintenance of product descriptions in the Federal series of specifications, standards, and CID's.

§ 101-29.301-2 Federal Standardization Handbook.

The Assistant Administrator for Federal Supply and Services will issue and maintain on a current basis a "Federal Standardization Handbook." The Federal Standardization Handbook sets forth operating procedures and applicable definitions used in the development of Federal product descriptions under the Assigned Agency Plan described therein. Federal agencies shall adhere to the provisions of the handbook in the development and coordination of Federal product descriptions.

§ 101-29.301-3 Availability of Federal product descriptions.

The Assistant Administrator for Federal Supply and Services will promulgate and maintain on a current basis the "Index of Federal Specifications, Standards and Commercial Item Descriptions." The Index lists Federal product descriptions which have been printed and distributed, including

those which are mandatory for use, and identifies the sources from which these documents may be obtained. Supplements to the Index indicate the dates on which the use of new Federal product descriptions become mandatory. The Department of Defense also lists Federal product descriptions in the "Department of Defense Index of Specifications and Standards."

§ 101-29.301-4 Periodic review of Federal product descriptions.

The Assistant Administrator for Federal Supply and Services is responsible for establishing a program for periodically reviewing Federal product descriptions to determine whether revision, cancellation or reauthorization (validation) is appropriate. The frequency of the review shall be based on the degree of change in the technology of the product covered by the description and shall be conducted at least once every 5 years.

§ 101-29.302 Other Federal agencies.

Heads of other Federal agencies are responsible for adhering to the policies and procedures established by GSA for management and control of Federal product descriptions and for the use of these documents in acquisition as applicable.

§ 101-29.303 All Federal executive agencies.

(a) Federal executive agencies shall evaluate the effectiveness of their Federal product descriptions by:

(1) Establishing a system for obtaining user critiques of products acquired using those descriptions; and

(2) Establish a method whereby the preparing activity can locate and communicate with the users.

(b) The system shall encourage users to communicate with acquisition organizations regarding:

(1) The user's essential requirements;

(2) Product suitability for use in the user's environment;

(3) Product failures and deficiencies;

(4) The needs of the logistics system; and

(5) Suggestions for corrective actions.

(c) Acquisition organizations shall designate a central point in each agency to evaluate and respond to user critiques and take corrective action on reasonable complaints and suggestions.

(d) At the time of the periodic review, the responsible preparing activity shall consider available user evaluations, the results of market research and analysis, and all reported deviations from the product description. Information, such as the following shall be examined in the review process:

(1) Whether the product description is still needed in its present form and scope or whether a more simplified one can be used;

(2) The existence of voluntary standards or other Government product descriptions that may better reflect current requirements;

(3) The need to convert Federal and agency specifications covering commercial or commercial-type products to CID's; and

(4) The currency and applicability of reference documents included in the product description.

Subpart 101-29.4—Mandatory Use of Federal Product Descriptions

§ 101-29.401 Federal product descriptions listed in the GSA Index of Federal Specifications, Standards and Commercial Item Descriptions.

(a) Federal product descriptions shall be used by all Federal agencies in the procurement of supplies and services covered by such descriptions, except as provided in § 101-29.402 and § 101-29.403.

(b) The order of preference in selecting Federal product descriptions for acquisition shall be:

(1) Any Federal product description adopting voluntary standards.

(2) Commercial item descriptions.

(3) Federal specifications and standards.

§ 101-29.402 Exceptions to mandatory use of Federal product descriptions.

(a) Federal product descriptions do not need to be used under any of the following circumstances:

(1) The purchase is required under a public exigency and a delay in obtaining agency requirements would be in-

involved in using the applicable description.

(2) The total amount of the purchase is less than \$10,000. (Multiple small purchases of the same item shall not be made for the purpose of avoiding the intent of this exception. Further, this exception in no way affects the requirements for the procurement of items available from GSA supply distribution facilities, Federal Supply Schedule contracts, GSA procurement programs, and certain procurement sources other than GSA that have been assigned supply responsibility for Federal agencies as provided in subparts 101-26.3, § 101-26.4, and § 101-26.5).

(3) The items are purchased in foreign markets for use of overseas activities of agencies.

(4) The products are adequately described in voluntary standards or in standards mandated by law.

(5) The acquisition involves a one-time procurement.

(6) A Federal product description is not currently available and is not expected to be available within a reasonable time of the scheduled acquisition action.

(7) The product is available only from a single source or is produced to a single manufacturer's design.

(8) The product is unique to a single system.

(9) The product (excluding military clothing) is acquired for authorized resale.

(b) If the purchase involves the following, Federal product descriptions do not need to be used except to the extent they are applicable, in whole or in part:

(1) Items required in construction of facilities for new processes or new installations of equipment;

(2) Items required for experiment, test, or research and development; or

(3) Spare parts, components, or material required for operation, repair, or maintenance of existing equipment.

§ 101-29.403 Federal product description exceptions and tailoring.

§ 101-29.403-1 Authorization of exceptions.

When the exceptions listed in § 101-29.402 do not apply and an applicable indexed product description is desired

§ 101-29.403-2

for use in procurement but does not meet an agency's essential needs, exceptions to the product description to effect procurement may be authorized as follows:

(a) All exceptions to Federal telecommunications standards require prior approval by the Assistant Administrator for Information Resources Management, General Services Administration, Washington, DC 20405.

(b) Preparing activities may designate specific product descriptions that require approval of exceptions by the preparing activity before use.

(c) Exceptions to Federal product descriptions that do not require prior approval under paragraphs (a) and (b) of this section may be authorized by the acquiring agency if:

(1) Justifications for exceptions are subject to review before authorization and that such justification can be fully substantiated if post audit is required;

(2) Notification of exception or recommendation for change to the Federal product description is sent promptly to the preparing activity and the General Services Administration (FCO), Washington, DC 20406.

(A statement of the exception with a justification and, where applicable, recommendation for revision or amendment to the description)

§ 101-29.403-2 Agency responsibility relative to exceptions to Federal product descriptions.

Each agency taking exceptions shall establish procedures whereby a designated official having substantial procurement responsibility shall be responsible for assuring that Federal product descriptions are used and provisions for exceptions are complied with.

§ 101-29.403-3 Tailoring of Federal product descriptions.

Product descriptions prepared to define and impose performance characteristics, engineering disciplines, and manufacturing practices such as reliability, system safety, quality assurance, maintainability, configuration management, and the like shall be tailored in accordance with their specific application in acquisitions.

41 CFR Ch. 101 (7-1-01 Edition)

Subpart 101-29.5—Use of and Optional Use of Federal Product Descriptions and Agency Product Descriptions

§ 101-29.501 Optional use of interim Federal specifications.

Interim Federal specifications are for optional use. All agencies are urged to make maximum use of them and to submit suggested changes to the preparing activity for consideration in further development of the specifications for promulgation as Federal specifications or commercial item descriptions. Interim revisions or interim amendments to Federal specifications are for optional use as valid exceptions to the Federal specifications so revised or amended and must, therefore, be specifically identified by symbol and date in the invitation for bids or request for proposal.

§ 101-29.502 Use of Federal specifications and interim Federal specifications in Federal construction contracts.

When material, equipment, or services covered by an available Federal specification or interim Federal specification are specified in connection with Federal construction, the Federal specification or interim Federal specification shall be made part of the specification for the construction contract, subject to provisions in §§ 101-29.402, 101-29.403, and 101-29.501.

§ 101-29.503 Agency product descriptions.

When a Federal product description is not available, existing agency product descriptions should be used by all agencies consistent with each agency's procedures for establishing priority for use of such descriptions.

PART 101-30—FEDERAL CATALOG SYSTEM

- Sec.
- 101-30.000 Scope of part.
- 101-30.001 Applicability.

Subpart 101-30.1—General

- 101-30.100 Scope of subpart.
- 101-30.101 Definitions.
- 101-30.101-1 Civil agency item.

Federal Property Management Regulations

§ 101-30.000

- 101-30.101-1a Item of production.
- 101-30.101-2 Item of supply.
- 101-30.101-3 National stock number.
- 101-30.101-4 Federal item identification.
- 101-30.101-5 Cataloging.
- 101-30.101-6 Cataloging activity.
- 101-30.101-7 Federal Catalog System.
- 101-30.101-8 Conversion.
- 101-30.101-9 Item entry control.
- 101-30.101-10 GSA section of the Federal Supply Catalog.
- 101-30.101-11 Recorded data.
- 101-30.101-12 Item identification data.
- 101-30.101-13 Management data.
- 101-30.101-14 Maintenance action.
- 101-30.101-15 Data preparation.
- 101-30.101-16 Data transmission.
- 101-30.101-17 Supply support.
- 101-30.101-18 Supply support request.
- 101-30.102 Objectives.
- 101-30.103 Responsibilities.
- 101-30.103-1 General.
- 101-30.103-2 Agency responsibilities.

Subpart 101-30.2—Cataloging Handbooks and Manuals

- 101-30.201 General.
- 101-30.202 Policies.

Subpart 101-30.3—Cataloging Items of Supply

- 101-30.300 Scope of subpart.
- 101-30.301 Types of items to be cataloged.
- 101-30.302 Types of items excluded from cataloging.
- 101-30.303 Responsibility.
- 101-30.304 Application of item entry control.
- 101-30.305 Exemptions from the system.

Subpart 101-30.4—Use of the Federal Catalog System

- 101-30.400 Scope of subpart.
- 101-30.401 Data available from the Federal Catalog System.
- 101-30.401-1 Publications providing Federal catalog data.
- 101-30.401-2 Automated catalog data output.
- 101-30.402 Conversion.
- 101-30.403 Utilization.
- 101-30.403-1 Reports of excess and surplus personal property.
- 101-30.403-2 Management codes.
- 101-30.404 Supply support.
- 101-30.404-1 Consolidation of supply support requests.

Subpart 101-30.5—Maintenance of the Federal Catalog System

- 101-30.500 Scope of subpart.
- 101-30.501 Applicability.
- 101-30.502 [Reserved]
- 101-30.503 Maintenance actions required.
- 101-30.504 Cataloging data from Defense Logistics Services Center (DLSC).

- 101-30.505 Assistance by Government suppliers.

Subpart 101-30.6—GSA Section of the Federal Supply Catalog

- 101-30.600 Scope of subpart.
- 101-30.601 Objective.
- 101-30.602 Authority for issuance.
- 101-30.603 GSA Supply Catalog.
- 101-30.603-1 [Reserved]
- 101-30.603-2 GSA Supply Catalog.
- 101-30.603-3—101-30.603-4 [Reserved]
- 101-30.603-5 Change bulletins.
- 101-30.603-6 Special Notices.
- 101-30.604 Availability.

Subpart 101-30.7—Item Reduction Program

- 101-30.700 Scope of subpart
- 101-30.701 Definitions.
- 101-30.701-1 Item reduction study.
- 101-30.701-2 Item standardization code.
- 101-30.701-3 Preparing activity.
- 101-30.701-4 Standardization relationship.
- 101-30.702 Determining item reduction potential.
- 101-30.703 Program objectives.
- 101-30.704 Agency responsibilities.
- 101-30.704-1 General Services Administration.
- 101-30.704-2 Other agencies.
- 101-30.705 GSA assistance.

Subparts 101-30.8—101-30.48 [Reserved]

Subpart 101-30.49—Illustrations of Forms

- 101-30.4900 Scope of subpart.
- 101-30.4901 Standard forms.
- 101-30.4901-1303 Standard Form 1303, Request for Federal Cataloging/Supply Support Action.

AUTHORITY: Sec. 205(c), 63 Stat. 390; 40 U.S.C. 486(c).

§ 101-30.000 Scope of part.

This part provides for a Federal Catalog System by which items of supply under § 101-30.301 are uniformly named, described, classified, and assigned national stock numbers (NSN's) to aid in managing all logistical functions and operations from determination of requirements through disposal. This system provides a standard reference language or terminology to be used by personnel in managing these items of supply, a prerequisite for integrated item management under the Federal procurement system concept.

[46 FR 35644, July 10, 1981]

§ 101-30.001

41 CFR Ch. 101 (7-1-01 Edition)

§ 101-30.001 Applicability.

The provisions of this part are applicable to all Federal agencies. However, they shall apply to the Department of Defense only when so specified within or by the subparts of this part.

[36 FR 20292, Oct. 20, 1971]

Subpart 101-30.1—General

SOURCE: 29 FR 16004, Dec. 1, 1964, unless otherwise noted.

§ 101-30.100 Scope of subpart.

This subpart defines the objectives of the Federal Catalog System, and assigns responsibilities for its operation. The basic principles and procedures of the Federal Catalog System are contained in published cataloging handbooks and manuals described in subpart 101-30.2.

§ 101-30.101 Definitions.

As used in this part 101-30, the following terms shall have the meanings set forth in this § 101-30.101.

§ 101-30.101-1 Civil agency item.

Civil agency item means an item of supply in the supply system of one or more civilian agencies, which is repetitively procured, stocked, or otherwise managed (includes direct delivery requirements as well as items stocked for issue).

[46 FR 35644, July 10, 1981]

§ 101-30.101-1a Item of production.

Item-of-production means those articles, equipment, materials, parts, pieces, or objects produced by a manufacturer which conform to the same engineering drawing, standard, or specification and receive the same quality control and inspection.

[46 FR 35644, July 10, 1981]

§ 101-30.101-2 Item of supply.

Item of supply means an item of production that is purchased, cataloged, and assigned a national stock number by the Government. The item of supply is determined by the requirements of each Government agency's supply system. The item of supply concept differentiates one item from another item

in the Federal Catalog System. Each item of supply is expressed in and fixed by a national item identification number. An item of supply may be:

- (a) A single item of production;
- (b) Two or more items of production that are functionally interchangeable;
- (c) A more precise quality controlled item than the regular item of production, or
- (d) A modification of a regular item of production.

[46 FR 35644, July 10, 1981]

§ 101-30.101-3 National stock number.

The *national stock number* (NSN) is the identifying number assigned to each item of supply. The NSN consists of the 4-digit Federal Supply Classification (FSC) code and the 9-digit national item identification number (NIIN). The written, printed, or typed NSN configuration is 1234-00-567-8901. The following terms are elements of the 13-digit national stock number:

(a) *Federal Supply Classification* (FSC) is a 4-digit number which groups similar items into classes.

(b) *National Codification Bureau* (NCB) code is a 2-digit number designating the central cataloging office of the NATO or other friendly country which assigned the national item identification number (NIIN) and is used as the first two digits of the NIIN.

(c) *National item identification number* (NIIN) is a 9-digit number composed of the NCB code number (2-digits) followed by 7 other nonsignificant digits.

[41 FR 11308, Mar. 18, 1976]

§ 101-30.101-4 Federal item identification.

Federal item identification means the approved item identification for the item of supply, plus the national stock number assigned to that item identification. It consists of four basic elements: The name of the item, the identifying characteristics, the Federal Supply Classification code, and the national item identification number.

[41 FR 11308, Mar. 18, 1976]

§ 101-30.101-5 Cataloging.

Cataloging means the process of uniformly identifying, describing, classifying, numbering, and publishing

Federal Property Management Regulations

§ 101-30.101-14

in the Federal Catalog System all items of personal property (items of supply) repetitively procured, stored, issued, and/or used by Federal agencies.

[41 FR 11308, Mar. 18, 1976]

§ 101-30.101-6 Cataloging activity.

Cataloging activity means the activity of a Federal agency having responsibility for performing cataloging operations in identifying and describing items of supply in the Federal Catalog System.

[41 FR 11308, Mar. 18, 1976]

§ 101-30.101-7 Federal Catalog System.

Federal Catalog System means the single supply catalog system designed to uniformly identify, classify, name, describe, and number the items of personal property used by the Federal Government by providing only one classification, one name, one description, and one item identification number for each item of supply. It provides a standard reference language or terminology to be used by all persons engaged in the process of supply.

[41 FR 11308, Mar. 18, 1976]

§ 101-30.101-8 Conversion.

Conversion means the changeover from using existing supply classifications, stock numbers, names, and identification data to using those of the Federal Catalog System in all supply operations, from determination of requirements to final disposal.

[41 FR 11308, Mar. 18, 1976]

§ 101-30.101-9 Item entry control.

Item entry control means the functional responsibility of GSA/DOD cataloging to minimize the number of items in the supply system by: (a) Establishing controls that prevent unnecessary new items from entering the supply system; (b) promoting the development of standards and use of standard items; and (c) eliminating items having nonstandard characteristics, and isolating and recommending the use of duplicate or replacement items.

[46 FR 35645, July 10, 1981]

§ 101-30.101-10 GSA section of the Federal Supply Catalog.

GSA section of the Federal Supply Catalog means a series of supply catalogs issued by GSA as an integral part of the Federal Supply Catalog. These catalogs indicate the source for obtaining supplies and services and contain ordering instructions and related supply management data.

[41 FR 11308, Mar. 18, 1976]

§ 101-30.101-11 Recorded data.

Recorded data means the data which are associated with a national stock number and are recorded on microfilm or magnetic computer tape at the Defense Logistics Center (DLSC), Battle Creek, MI 49016.

[41 FR 11308, Mar. 18, 1976]

§ 101-30.101-12 Item identification data.

Item identification data means recorded data which are used to differentiate an item from all other items. Item identification data are composed of data that describe the essential physical characteristics of the item and reference data that relate the item to other identifying media (such as manufacturers' part numbers, identified blueprints, suppliers' catalogs, or the like).

[41 FR 11308, Mar. 18, 1976]

§ 101-30.101-13 Management data.

Management data means recorded data that relate an item to the individual agency's supply system for purposes of supply management as standardization, source of supply, or inventory control. Management data do not affect the identification of an item.

[41 FR 11308, Mar. 18, 1976]

§ 101-30.101-14 Maintenance action.

Maintenance action means any action taken after conversion to the Federal Catalog System which changes the previously reported identification or management data regarding a cataloged item.

[46 FR 35645, July 10, 1981]

§ 101-30.101-15

§ 101-30.101-15 Data preparation.

Data preparation means the conversion of item identification and management data to the appropriate Automated Data Processing (ADP) format.

[41 FR 11308, Mar. 18, 1976]

§ 101-30.101-16 Data transmission.

Data transmission means the operation of telecommunication equipment for the receipt and transmission of item identification and management data.

[41 FR 11308, Mar. 18, 1976]

§ 101-30.101-17 Supply support.

Supply support means the functions performed by the supply manager to provide requesting (using) activities with a Government source and method of supply for an item; e.g., GSA stock program, Federal supply schedule program, GSA's buy-on-demand program, or GSA's authorizing an agency to purchase locally.

[43 FR 42257, Sept. 20, 1978]

§ 101-30.101-18 Supply support request.

Supply support request means a request from an activity to a supply manager; e.g., a request to GSA to provide that activity with supply support for an item.

[43 FR 42257, Sept. 20, 1978]

§ 101-30.102 Objectives.

The objectives of the Federal cataloging program are:

(a) To provide for the maintenance of a uniform Federal supply catalog system and the conversion to and exclusive use of this system by all Federal agencies.

(b) To name, describe, identify, classify, and number each item of personal property to be included in the Federal Catalog System so that the same items will have a single Federal item identification within and among the organizational elements of all Federal agencies.

(c) To collect, maintain, and publish such Federal catalog data and related supply management data as may be determined necessary or desirable to re-

41 CFR Ch. 101 (7-1-01 Edition)

flect such benefits to supply management as:

(1) Assistance in standardization of supplies and equipment;

(2) Disclosure of interchangeability and substitutability of items;

(3) Reduction in inventories of stock and increased rates of turnover;

(4) Increase in vendor competition and broader sources of supply;

(5) Provision of data for determining the most effective and economical method of item management on a Federal agency systemwide basis;

(6) Enhance item entry control;

(7) Facilitation of better interagency and intra-agency use of supplies, equipment, and excess stocks, and more exact identification of surplus personal property; and

(8) Assistance in providing precise statistics for budget and financial accounting purposes.

[29 FR 16004, Dec. 1, 1964, as amended at 36 FR 20292, Oct. 20, 1971; 41 FR 11308, Mar. 18, 1976]

§ 101-30.103 Responsibilities.

§ 101-30.103-1 General.

(a) The provisions of section 206 of the Federal Property and Administrative Services Act of 1949 (40 U.S.C. 487) authorize the Administrator of General Services to establish and maintain a uniform Federal Catalog System to identify and classify personal property under the control of Federal agencies. Under this law each Federal agency is required to utilize the uniform Federal Catalog System, except as the Administrator of General Services shall otherwise provide, taking into consideration efficiency, economy, and other interests of the Government.

(b) The Defense Cataloging and Standardization Act (chapter 145, title 10, U.S. Code) authorizes the Secretary of Defense to develop a single supply catalog system for the Department of Defense.

(c) Both laws require that the Administrator of General Services and the Secretary of Defense shall coordinate the cataloging activities of GSA and the Department of Defense to avoid unnecessary duplication.

[29 FR 16004, Dec. 1, 1964, as amended at 41 FR 11309, Mar. 18, 1976]

Federal Property Management Regulations

§ 101-30.202

§ 101-30.103-2 Agency responsibilities.

(a) Each civil agency shall:

(1) Participate in the preparation and maintenance of the civil agency portion of the Federal Catalog System and in the conversion to and utilization of this system, and

(2) Comply with the policies, principles, rules, and procedures of the Federal Catalog System as prescribed in this part 101-30.

(b) Adherence by the Department of Defense to the single supply catalog system developed for the military departments under chapter 145, title 10, U.S. Code, shall be deemed to constitute full coordination of cataloging activities with GSA.

Subpart 101-30.2—Cataloging Handbooks and Manuals

§ 101-30.201 General.

(a) This subpart describes the cataloging handbooks and manuals prepared by the Defense Logistics Agency, Department of Defense, in coordination with GSA.

(b) The following basic cataloging handbooks and manuals are available for purchase from the Superintendent of Documents, Government Printing Office, Washington, DC 20402. The requirements of these publications shall be followed by all cataloging activities participating in the Federal Catalog System.

(1) *Federal Catalog System Policy Manual (DOD 4130.2-M)*. This hard copy manual prescribes the operating policies and instructions covering the maintenance of a uniform catalog system.

(2) *Defense Integrated Data Systems (DIDS) Procedures Manual (DOD 4100.39-M)*. This hard copy manual prescribes the procedures covering the maintenance of a uniform catalog system.

(3) *Federal Supply Classification (Cataloging Publication H2 Series)*. This microfiche publication includes the listings and indexes necessary for using the commodity classification system (grouping related items of supply) as prescribed by the Federal Catalog System Policy Manual.

(4) *Federal Supply Code for Manufacturers (Cataloging Publication H4 Series)*.

This microfiche publication includes a comprehensive listing of the names and addresses of manufacturers who have supplied or are currently supplying items of supply used by the Federal Government and the applicable 5-digit code assigned to each.

(5) *Federal Item Name Directory (FIND) for Cataloging (Cataloging Publication H6 Series)*. This microfiche publication includes names of supply items with definitions, item name codes, and other related data required to prepare item identifications for inclusion in the Federal Catalog System.

[29 FR 16004, Dec. 1, 1964, as amended at 42 FR 36254, July 14, 1977; 46 FR 35645, July 10, 1981]

§ 101-30.202 Policies.

The cataloging publications indicated in § 101-30.201 provide a ready reference to the following operating policies and rules covering the uniform catalog system:

(a) *Identification*. (1) Each civil agency shall ensure that each of its items authorized for cataloging is included and maintained in the Federal Catalog System as prescribed in the Federal Catalog System Policy Manual.

(2) Each item of supply shall have applicable to it one, and only one, Federal item identification; each Federal item identification shall be applicable to one, and only one, item of supply.

(b) *Federal Supply Classification (FSC)*. (1) The Federal Supply Classification shall be used in supply management within the civil agencies.

(2) Each item included in the Federal Catalog System shall be classified under the Federal Supply Classification and shall be assigned only one 4-digit class in accordance with the rules prescribed in the Federal Catalog System Policy Manual.

(c) *Numbering*. (1) Each item of supply identified in the Federal Catalog System shall be assigned a national stock number which shall consist of the applicable 4-digit FSC class code and a 9-digit national item identification number.

(2) The national stock number shall be the only stock number used in supply operations for items within the scope of the Federal Catalog System. The integrity of the national stock

§ 101-30.300

number shall always be maintained whenever it is employed in any operation or document. Supply management codes, or other management symbols, may be associated with, but never included as a part of the national stock number. These management codes or symbols shall always be separated from the national stock number in such a manner that the national stock number is clearly distinguishable.

[29 FR 16004, Dec. 1, 1964, as amended at 39 FR 37060, Oct. 17, 1974; 41 FR 11309, Mar. 18, 1976]

Subpart 101-30.3—Cataloging Items of Supply

§ 101-30.300 Scope of subpart.

This subpart prescribes the types of items to be cataloged, the types of items to be excluded from the Federal Catalog System, the responsibilities for catalog data preparation and transmission to the Defense Logistics Services Center (DLSC), and the application of item entry control procedures upon request for cataloging action.

[42 FR 36255, July 14, 1977]

§ 101-30.301 Types of items to be cataloged.

Items of personal property in the civil agency systems that are subject to repetitive procurement, storage, distribution and/or issue, and all locally purchased, centrally managed items will be named, described, identified, classified, and numbered (cataloged) in the Federal Catalog System. Other locally purchased items may be cataloged based upon civil agency requirements. The term "repetitive" will be construed to mean continual or recurring and applies to those items for which a need is deemed to exist within the appropriate civil agency.

[41 FR 11309, Mar. 18, 1976]

§ 101-30.302 Types of items excluded from cataloging.

Items of personal property in the following categories are to be excluded from the Federal Catalog System except when an agency determines that Federal item identification data will be of value in its supply management operations:

41 CFR Ch. 101 (7-1-01 Edition)

(a) Capital equipment items which are nonexpendable and are especially designed for a specific purpose, such as elevators or central air-conditioning system installations.

(b) Items of personal property on which security classification is imposed.

(c) Items procured on a one-time or infrequent basis for use in research and development, experimentation, construction, or testing and not subject to centralized item inventory management, reporting, or stock control.

(d) Items procured in foreign markets for use in overseas activities of Federal agencies.

(e) Printed forms.

[29 FR 16004, Dec. 1, 1964, as amended at 41 FR 11309, Mar. 18, 1976; 42 FR 36255, July 14, 1977]

§ 101-30.303 Responsibility.

Each agency shall ensure that each of its items to be cataloged is included and maintained in the Federal Catalog System.

(a) Agencies with cataloging and data preparation and transmission capabilities, when authorized by GSA, shall submit data direct to the Defense Logistics Services Center (DLSC) in conformance with procedures set forth in the Defense Integrated Data System (DIDS) Procedures Manual (DOD 4100.39-M).

(b) Agencies not having the capabilities cited in paragraph (a) of this section shall submit their request to the appropriate cataloging activity; i.e., GSA or VA, for the performance of all cataloging functions and/or the preparation of data for submission to DLSC. Cataloging requests to GSA or VA shall be prepared using Standard Form 1303, Request for Federal Cataloging/Supply Support Action (illustrated at § 101-30.4901-1303). EAM card formatted requests for volume add/delete user actions may also be submitted. Instructions on the preparation of Standard Form 1303 and EAM card formatted requests and guidance in determining the appropriate cataloging activity designated to receive requests are in the GSA Handbook, Federal Catalog System-Logistics Data (FPMR 101-30.3), issued by the Commissioner, Federal Supply Service.

Federal Property Management Regulations

§ 101-30.401-1

(c) GSA will confer with civil agencies periodically to review and devise methods of submission according to their needs and capabilities.

[42 FR 36255, July 14, 1977, as amended at 46 FR 35645, July 10, 1981]

§ 101-30.304 Application of item entry control.

In addition to the reviews attendant to the process of item identification and assignment of national stock numbers, proposed new items will be subjected to a technical review to associate them with items available through the GSA supply system. Where a similar item is available through the GSA supply system, the agency will be informed of the national stock number and a source of supply and will be requested to use that item. If the requesting agency considers the GSA item unacceptable because of technical differences, the requesting agency shall notify GSA of the technical differences between the alternate item and the requested item to allow for the assignment of a new national stock number to the requested item.

[46 FR 35645, July 10, 1981]

§ 101-30.305 Exemptions from the system.

When an agency believes that the benefits of the Federal Catalog System may be realized without formal participation, a request for an exemption shall be submitted to the General Services Administration (FRI), Washington, DC 20406. After reviewing the request for an exemption, GSA will inform the requesting agency of the decision and will provide instructions for implementation. The request for an exemption shall include, but not be limited to, the following information:

(a) Number of items repetitively procured, stored, distributed, or issued.

(b) Number of items currently used having national stock numbers.

(c) Identification system planned or in use other than the Federal catalog system.

(d) Whether procurement is centralized.

(e) Description of any catalogs published. If none, so state.

(f) Whether supply support is received from another agency including the name of the agency and category of item involved; e.g., electronics.

(g) Cost differential between submitting a request for cataloging action and identifying the item under the agency's current or planned system.

[43 FR 42257, Sept. 20, 1978, as amended at 46 FR 35645, July 10, 1981]

Subpart 101-30.4—Use of the Federal Catalog System

§ 101-30.400 Scope of subpart.

This subpart prescribes the policies and procedures governing the dissemination of Federal catalog data, the conversion to and use of the Federal catalog system by Federal agencies, and the requesting of supply support from Government supply managers.

[43 FR 42257, Sept. 20, 1978]

§ 101-30.401 Data available from the Federal Catalog System.

Federal Catalog System data are available in publications of general interest to Government supply activities and in the form of automated output tailored to meet individual agency needs.

[42 FR 36255, July 14, 1977]

§ 101-30.401-1 Publications providing Federal catalog data.

(a) Federal Catalog System publications contain selected data from the Defense Logistics Services Center (DLSC) files chosen, assembled, and formatted to meet recognized needs for information in support of assigned missions, functions, and related responsibilities. Most publications are produced in microfiche form; however, some are produced in hard copy form. The following publications are available:

(1) *Master cross-reference list*. A microfiche publication which contains a master list of national stock numbers (NSN's) cross-referenced to and from manufacturers' part numbers, specifications, or reference drawings. This publication is used to cross-relate reference numbers and stock numbers or to ascertain the manufacturer of an

§ 101-30.401-2

item when the reference number or the NSN is known.

(2) *Identification list (IL)*. A microfiche publication arranged by Federal supply class and containing descriptions of items in the DLSC file. The principal uses of the IL are to obtain or verify an NSN when only the characteristics of the item are known or descriptive data when the NSN is known, and to determine interchangeable or substitutable items.

(3) *Consolidated Management Listing*. A microfiche publication which is a consolidated listing of NSN's and related supply management data of each integrated manager and military service. These data include Government source of supply, unit of issue, unit price, etc.

(4) *Federal item logistics data records (FILDR)*. A microfiche publication containing complete identification data in tabular format for all descriptive-type item identifications. The data are arranged in NSN sequence within Federal supply class. An FILDR is known in hard copy form as a DD-146 card which is furnished as an output to authorized receivers of Federal catalog data who cannot use other available output media.

(5) *Defense Logistics Agency (DLA) Federal Supply Catalog for Civil Agencies*. This publication (available in hard copy only) includes NSN's for which DLA is the single source of supply for civil agencies. These NSN's may not necessarily have a DOD user recorded. The publication contains descriptive and management data for items not usually listed in the GSA catalog but which might be required by civil agencies.

(b) Agencies may obtain without charge copies of the DLA Federal Supply Catalog for Civil Agencies, described in paragraph (a)(6)¹ of this section by contacting the Defense Logistics Services Center, DLSC-TP, Federal Center, Battle Creek, MI 49016. To obtain copies of the publications described in paragraphs (a) (1) through (5) of this section, agencies may submit a request in writing to the same address shown above, except that the applicable mail distribution code is DLSC-AP.

¹At 46 FR 35645, July 10, 1981, paragraph (a)(6) of § 101-30.401-1 was removed.

41 CFR Ch. 101 (7-1-01 Edition)

Information concerning the charges for the latter publications is available from DLSC-AP.

[42 FR 36255, July 14, 1977, as amended at 46 FR 35645, July 10, 1981]

§ 101-30.401-2 Automated catalog data output.

As a result of participation in the Federal catalog system, activities may receive data directly from DLSC tailored to their individual needs in support of their own supply management data system. The two basic categories of file maintenance are:

(a) *Simplified file maintenance (SFM)*. Subscribers to this category of file maintenance are provided replacement files (magnetic tape) semiannually containing selected technical and supply management data for those items on which they are a registered user. The subscriber will also receive a monthly maintenance update and cumulative monthly basic records from DLSC which may be used to maintain the semiannual basic file. Recipients of this form of file maintenance have latitude in selecting those items which meet the needs of their supply system from the categories of data available from the Federal Catalog System.

(b) *Regular file maintenance (RFM)*. This form of the file maintenance provides activities with data on a daily basis as transactions affect items upon which they are a registered user. It is used primarily by those activities which consider it essential to maintain file compatibility with the DLSC file at all times.

[42 FR 36255, July 14, 1977]

§ 101-30.402 Conversion.

Following completion of cataloging action, GSA will establish a time period in which conversion to the Federal Catalog System shall be accomplished by all civil agencies. The terminal dates for conversion will be established after consultation with the civil agencies concerned.

[29 FR 16004, Dec. 1, 1964]

§ 101-30.403 Utilization.

On and after the established date for completion of conversion, all inter-agency and intra-agency transactions

Federal Property Management Regulations

§ 101-30.501

involving item identifications, commodity classification, or stock numbers shall be in the terms of the Federal Catalog System.

[29 FR 16004, Dec. 1, 1964]

§ 101-30.403-1 Reports of excess and surplus personal property.

For items of personal property which have been identified in the Federal Catalog System, national stock numbers and Federal item identifications, with such additional descriptive detail as is required, shall be utilized in reports and listings of excess and surplus personal property. The assignment of national stock numbers and Federal item identifications shall not be required for items of excess or surplus personal property which have not been identified in the Federal Catalog System.

[39 FR 37060, Oct. 17, 1974]

§ 101-30.403-2 Management codes.

For internal use within an agency, alphabetic codes excluding letters "I" and "O" may be prefixed or suffixed to the national stock number as CM7520-00-123-4567 or 7520-00-123-4567CM, as required for supply management operations. Numeric codes shall not be affixed immediately adjacent to or as a part of the national stock number, nor shall codes be intermingled in the national stock number.

[41 FR 11309, Mar. 18, 1976]

§ 101-30.404 Supply support.

Civilian agencies requiring supply support on an item of supply shall request this action by preparing Standard Form 1303, Request for Federal Cataloging/Supply Support Action (illustrated at § 101-30.4901-1303), and submitting the form to the General Services Administration (FRIS), Washington, DC 20406. All supply support request for nonperishable subsistence items in Federal Supply Group 89, subsistence (except condiment packets in FSC classes 8940 and 8950), shall be submitted to the Veterans Administration, Catalog Division (901S), Veterans Administration Supply Depot, P.O. Box 27, Hines IL 60141. Guidance on the preparation of supply support requests is in the GSA Handbook, Federal Cata-

log System-Logistics Data (FPMR 101-30.3), issued by the Commissioner, Federal Supply Service.

[46 FR 55991, Nov. 13, 1981]

§ 101-30.404-1 Consolidation of supply support requests.

Requests for supply support should be consolidated in one focal point within each agency or activity. On the basis of the total consolidated agency or activity requirement; i.e., annual demand, GSA can determine the most economical and efficient method of supply support.

[43 FR 42257, Sept. 20, 1978]

Subpart 101-30.5—Maintenance of the Federal Catalog System

§ 101-30.500 Scope of subpart.

This subpart prescribes the policies and procedures governing the maintenance of the Federal Catalog System.

[31 FR 11106, Aug. 20, 1966]

§ 101-30.501 Applicability.

(a) The Administrator of General Services delegated authority to the Secretary of Defense to develop and maintain the Federal Catalog System. This delegation provided for the cataloging system to continue to provide for the identification and classification of personal property under the control of Federal agencies and to maintain uniform item management data required and suitable for interdepartment supply activities.

(b) The Federal Catalog System Policy Manual (DOD 4130.2-M) and the Defense Integrated Data System (DIDS) Procedures Manual (DOD 4100.39-M) are equally applicable to all DOD and civilian agencies. The Federal Supply Service, GSA, and the Department of Defense share joint responsibility for the coordination of civilian agency cataloging to ensure the integrity of the system and the compatibility of civilian and military agency participation in the Federal Catalog System.

[46 FR 35646, July 10, 1981]

§ 101-30.502

41 CFR Ch. 101 (7-1-01 Edition)

§ 101-30.502 [Reserved]

§ 101-30.503 Maintenance actions required.

After converting to the Federal Catalog System, the agency concerned shall promptly take maintenance actions affecting the items converted and new items to be added. These actions may include deletion or revision of item identification or management data, or any other change required to ensure that the recorded data are maintained on a current basis. Submission of data to DLSC shall be as follows:

(a) As new items meeting criteria for national stock number (NSN) assignment are added to an agency's supply system, the agency shall submit data to GSA, the Defense Logistics Agency (DLA), the Veterans Administration (VA), or DLSC when a direct submitter of catalog data is involved in accordance with §101-30.303.

(b) All civilian agencies not authorized to submit catalog data direct to DLSC shall prepare Standard Form 1303, Request for Federal Cataloging/Supply Support Action (illustrated at §101-30.4901-1303), to request maintenance action. Maintenance requests shall be submitted to GSA for collaboration and submission to DLSC, except that civilian agencies receiving supply support on an item from a DLA center or the VA, as expressed by major organizational entity (MOE) rule, should submit these requests to the DLA center using DD Form 1685, Data Exchange and/or Proposed Revision of Catalog Data, or to the VA using Standard Form 1303, for collaboration and submission to DLSC. When GSA receives maintenance requests on these items, they will be forwarded to the appropriate DLA center or to the VA.

(c) Agencies authorized to submit catalog data direct to DLSC as provided in §101-30.303(a) shall comply with item maintenance and data collaboration procedures as set forth in the Defense Integrated Data System (DIDS) Procedures Manual (DOD 4100.39M).

(d) All civilian agencies not authorized to submit catalog data to DLSC shall use Standard Form 1303, Request for Federal Cataloging/Supply Support Action, to request maintenance action.

Proposed maintenance requests shall be submitted to GSA for collaboration and submission to DLSC, except that civilian agencies receiving supply support from DLA supply centers, as expressed in the DLSC user record by major organizational entity (MOE) rule, should submit proposed maintenance requests to the appropriate DLA supply center for collaboration and submission to DLSC. When GSA receives maintenance requests for these items, they will be referred to the appropriate DLA supply center.

(e) Any civilian agency participating in the Federal Catalog System (those agencies previously assigned a Cataloging Activity Code) may propose action for maintenance of the catalog system tools as outline in §101-30.201(b).

[41 FR 11310, Mar. 18, 1976, as amended at 42 FR 36255, July 14, 1977; 43 FR 18673, May 2, 1978; 46 FR 35646, July 10, 1981]

§ 101-30.504 Cataloging data from Defense Logistics Services Center (DLSC).

Upon receipt of cataloging data from civil agencies, DLSC will process the data and provide for their inclusion in the Federal Catalog System. Notification to the submitting and originating agencies of the action taken by DLSC will be as required in the Federal Catalog System Policy Manual (DOD 4130.2-M) and will be accomplished by means of electric accounting machine cards, magnetic tape, or wire transmission, according to the capabilities of those agencies. DLSC will send this information to the agencies that are designated by GSA as direct data receivers. Otherwise, DLSC will transmit the information to the submitting agency to be forwarded to the originating agency, when required.

[42 FR 36256, July 14, 1977]

§ 101-30.505 Assistance by Government suppliers.

When a new item is to be introduced into an agency supply system, the agency establishing the need for the new item shall determine whether or not adequate identification data for cataloging the item are available. If the data are not available, the agency may specify in procurement documents

Federal Property Management Regulations

§ 101-30.603-2

the use of Federal Standard No. 5, Standard Guides for Preparation of Proposed Item Logistics Data Records, and submission of the cataloging data required by that standard to the contracting officer (for further processing in accordance with this subpart 101-30.5).

[41 FR 11310, Mar. 18, 1976]

Subpart 101-30.6—GSA Section of the Federal Supply Catalog

§ 101-30.600 Scope of subpart.

This subpart describes that section of the Federal Supply Catalog issued by GSA and authorizes its issuance by the Commissioner, Federal Supply Service.

[35 FR 3071, Feb. 17, 1970]

§ 101-30.601 Objective.

GSA supply catalogs are primarily designed to aid in the acquisition of GSA centrally managed, stocked, and issued items available from GSA supply facilities by Federal civilian agencies and other organizations authorized to use the GSA Federal Supply Service (FSS) stock program as a source of supply. GSA also provides information relative to other FSS sales programs and GSA services.

[46 FR 35646, July 10, 1981]

§ 101-30.602 Authority for issuance.

The GSA section of the Federal Supply Catalog is issued as an integral part of the Federal Supply Catalog and the Federal Catalog System as prescribed in subpart 101-30.1. The Commissioner, Federal Supply Service, is authorized to publish catalogs for those items and programs for which GSA furnishes supply support to Federal agencies.

[35 FR 3071, Feb. 17, 1970]

§ 101-30.603 GSA Supply Catalog.

(a) The GSA Supply Catalog is an illustrated catalog, published annually, which serves as the primary source to identify and order centrally managed, stocked, and issued items available from GSA supply facilities. The catalog also provides information concerning other Federal Supply Service programs and GSA services.

(b) The GSA Supply Catalog contains all necessary information for ordering from the GSA Federal Supply Service stock program and basic information, such as:

(1) *Alphabetical Index*. This index is organized alphabetically by approved item names under the basic noun name in inverted word sequence, (i.e. sofa, sleeper) with reference to the page that contains the pertinent item description.

(2) *Item Descriptions/Ordering Data*. Item descriptions are listed by commodity groups in this section. Included also are descriptive and ordering data with representative illustrations for selected common-use items that are centrally managed, stocked, and issued from GSA supply facilities.

(3) *National Stock Number Index*. This NSN sequenced index lists items that are centrally managed, stocked, and issued from GSA supply facilities.

(4) *Narrative*. The narrative includes comprehensive detailed information to use and understand the GSA Federal Supply Service stock program.

(5) *Other Federal Supply Service sales programs and GSA services*. This section provides to user agencies pertinent information regarding the use and understanding of the GSA Federal Supply Service stock program, sales program, and other GSA services.

(c) Changes to the GSA Supply Catalog are effected by change bulletins issued during April, July, and October. These are cumulative publications that contain information pertaining to new items, changes to supply management data, and deleted items.

(d) Special Notice to Ordering Office is issued on a nonscheduled basis as required by the Commissioner, FSS, to inform agencies of significant program changes to the GSA Supply Catalog.

[46 FR 35646, July 10, 1981]

§ 101-30.603-1 [Reserved]

§ 101-30.603-2 GSA Supply Catalog.

The GSA Supply Catalog, published annually and updated quarterly, is an illustrated publication which serves as the primary source for identifying items and services available through the following GSA supply sources:

(a) GSA supply distribution facilities;

§§ 101-30.603-3—101-30.603-4

- (b) Federal Supply Schedules; and
- (c) Term Contract Program.

[39 FR 37060, Oct. 17, 1974]

§§ 101-30.603-3—101-30.603-4 [Reserved]

§ 101-30.603-5 Change bulletins.

Changes to the GSA Supply Catalog are effected by quarterly cumulative publications entitled "Change Bulletin to the GSA Supply Catalog." These change bulletins will serve as the media to notify agencies of additions, deletions, and other pertinent changes occurring between the annual publication of the GSA Supply Catalog.

[38 FR 28568, Oct. 15, 1973]

§ 101-30.603-6 Special Notices.

Special Notices will be issued on a nonschedule basis to advise agencies of program changes, general information, or additions, deletions, and other pertinent changes to the GSA Supply Catalog.

[38 FR 28568, Oct. 15, 1973]

§ 101-30.604 Availability.

Agencies that require current copies of and desire to be placed on distribution lists to receive Federal supply catalogs and related publications shall complete GSA Form 457, FSS Publications Mailing List Application (illustrated at §101-26.4902-457), and forward the completed GSA Form 457 to General Services Administration (8BRC), Centralized Mailing Lists Services, Building 41, Denver Federal Center, Denver, CO 80225. Copies of GSA Form 457 may also be obtained from the above address. Periodically, the Centralized Mailing Lists Services will request information from agency offices for use in maintaining current distribution lists.

[46 FR 35646, July 10, 1981]

Subpart 101-30.7—Item Reduction Program

SOURCE: 43 FR 4999, Feb. 7, 1978, unless otherwise noted.

41 CFR Ch. 101 (7-1-01 Edition)

§ 101-30.700 Scope of subpart.

This subpart defines the objectives of the item reduction program and assigns responsibilities for its operation. Procedures implementing the policy set forth herein are contained in the GSA Handbook, Item Elimination (FPMR 101-30.7), issued by the Commissioner, Federal Supply Service.

§ 101-30.701 Definitions.

As used in this subpart 101-30.7, the following terms shall have the meanings set forth in this §101-30.701.

§ 101-30.701-1 Item reduction study.

Item reduction study means the study of a group of generally similar items which are subject to evaluation by physical and performance characteristics. This evaluation process identifies items determined to be unnecessarily similar or uneconomical for Government use and which will be considered for removal from Government supply systems. For items so identified, a replacement item shall be proposed. The result of item reduction studies will indicate items which are authorized for procurement or not authorized for procurement.

§ 101-30.701-2 Item standardization code.

Item standardization code (ISC) means a code assigned an item in the supply system which identifies the item as authorized for procurement or not authorized for procurement.

§ 101-30.701-3 Preparing activity.

Preparing activity means a Government agency responsible for the preparation of item reduction studies, or an activity authorized by the listed agencies to conduct an item reduction study. The DOD Standardization Directory SD-1 provides such a listing.

§ 101-30.701-4 Standardization relationship.

Standardization relationship means the relationship between the replaced item and the replacement item. The replaced item will contain an item standardization code designating the item as not authorized for procurement and therefore must have a replacement

Federal Property Management Regulations

§ 101-30.704-1

item. The relationship of the two items is displayed within the item reduction study by item standardization codes and, upon approval of the study, in the Federal catalog system data base at the Defense Logistics Services Center (DLSC).

§ 101-30.702 Determining item reduction potential.

Item reduction studies are required where there are large numbers of generally similar items which are subject to grouping and examination by item name, item name modifiers, or other characteristics such as sizes, grades, lengths, and materials. Before conducting a full scale item reduction study, the assignee activity shall determine whether sufficient item reduction potential appears to exist. Item reduction studies shall be undertaken only when the expected benefits outweigh the costs of performing the study.

§ 101-30.703 Program objectives.

The objective of the item reduction program is to reduce the varieties and sizes of similar items in the Government supply system by:

- (a) Implementing a coordinated item reduction process among supply managers of using activities;
- (b) Standardizing items of supply used by the Government;
- (c) Ensuring that all participants in item reduction studies give priority to controlling and completing item reduction studies;
- (d) Promptly recording decisions in the Federal catalog system data base; and
- (e) Phasing out of the Government supply system those items identified in item reduction studies as not authorized for procurement to reduce cataloging, supply management, and warehousing costs; then following through to eliminate the items from agency catalog systems.

[43 FR 4999, Feb. 7, 1978, as amended at 46 FR 35646, July 10, 1981]

§ 101-30.704 Agency responsibilities.

§ 101-30.704-1 General Services Administration.

(a) The General Services Administration (GSA) will develop or authorize other Government agencies to develop item reduction studies on items within the Federal supply classification (FSC) classes for which GSA is the integrated material manager.

(b) GSA, as the civil agency coordinating activity for item reduction studies originated by both GSA and DOD, will:

(1) Distribute proposed item reduction studies, as appropriate, to all civil agencies recorded as users of the item in the DLSC data base. This distribution will be made by coordination letters in which a time frame for a response will be specified. GSA will interpret each nonresponse to a proposed study to mean that the activity concurs with the study. Extensions, when requested by an agency, normally will be granted by GSA.

(2) Respond to questions concerning proposed item reduction studies.

(3) Prepare a consolidated civil agency position paper (including comments and nonconcurrences) relative to each study upon receipt of user responses.

(4) Incorporate civil agency positions into proposed item reduction studies prepared by GSA or forward a consolidated civil agency position paper to appropriate preparing activities.

(5) Resolve controversies arising from proposed item reduction study recommendations.

(6) Review approved item reduction studies to ensure that concurrences and nonconcurrences from all civil agencies are accurately reflected.

(7) Register into the Federal catalog system, data base approved item reduction decisions concerning items within the FSC classes which are managed by GSA.

(8) Implement decisions documented in approved item reduction studies within the GSA supply system.

§ 101-30.704-2

(9) Distribute approved item reduction studies to all recorded civil agency users. All civil agencies (except direct submitters of catalog data to DLSC) will also be forwarded covering letters which will request specific information relative to implementing the studies; i.e., inventory levels of items coded ISC 3. Activities not responding within the time frame specified (60 calendar days) will receive a followup notice before being automatically withdrawn as users of all items coded as not authorized for procurement.

[43 FR 4999, Feb. 7, 1978, as amended at 46 FR 35646, July 10, 1981]

§ 101-30.704-2 Other agencies.

Civil agencies participating in the Federal Catalog System shall:

(a) Conduct a review of the items included in the proposed study by the preparing activity with respect to the ISC to determine the impact the assigned code may have on the agency's supply system.

(b) Prepare and submit written comments on the proposed study to GSA within the time frame specified in the GSA coordination letter, concur with the study, or nonconcur on specific proposed standardization relationships. If comments cannot be prepared and submitted within the time frame specified, an extension shall be requested from GSA.

(c) Review the approved item reduction study and notify GSA in writing if the activity is to be retained or deleted as a user of any item coded as "not authorized for procurement." This notification will allow the preparer of the study to complete coordination of the study and update the DLSC Total Item Record (TIR).

(d) Implement within the agency those item reduction decisions resulting from the study.

(e) Request, as appropriate, the retention of a nonstandard item in their supply system by forwarding a letter to General Services Administration (FRIS), Washington, DC 20406. The request shall include but not be limited to the following information:

(1) The specific end-use of end-item application;

41 CFR Ch. 101 (7-1-01 Edition)

(2) A technical explanation comparing the physical and functional characteristics of the nonstandard item with each authorized-for-procurement item;

(3) The duration of the requirement for the item or how long the end-item will be retained in the agency's supply system; and

(4) Economic considerations from a technical standpoint. GSA will evaluate the request and inform the agency of its acceptance or rejection.

[43 FR 4999, Feb. 7, 1978, as amended at 46 FR 35647, July 10, 1981]

§ 101-30.705 GSA assistance.

Activities requiring assistance in fulfilling their responsibilities under the program shall contact the General Services Administration (FRI), Washington, DC 20406.

[46 FR 35647, July 10, 1981]

**Subparts 101-30.8—101-30.48
[Reserved]**

**Subpart 101-30.49—Illustrations of
Forms**

§ 101-30.4900 Scope of subpart.

This subpart illustrates forms prescribed or available for use in connection with subject matter covered in other subparts of this part 101-30.

[31 FR 11107, Aug. 20, 1966]

§ 101-30.4901 Standard forms.

(a) Standard forms are illustrated in this §101-30.4901 to show their text, format, and arrangement and to provide a ready source of reference. The subsection numbers in this §101-30.4901 correspond with the Standard form numbers.

(b) Standard forms illustrated in this §101-30.4901 may be obtained by submitting a requisition in FEDSTRIP format to the GSA regional office providing support to the requesting activity.

[43 FR 18674, May 2, 1978]

Federal Property Management Regulations

§ 101-33.000

§ 101-30.4901-1303 Standard Form 1303, Request for Federal Cataloging/Supply Support Action.

NOTE: The form illustrated in § 101-30.4901-1303 is filed with the original document and does not appear in the FEDERAL REGISTER.

[43 FR 18674, May 2, 1978]

PART 101-31—INSPECTION AND QUALITY CONTROL

Sec.

101-31.000 Scope of part.

Subpart 101-31.1 [Reserved]

Subpart 101-31.2—Private Inspection, Testing, and Grading Services

101-31.200 Cross-reference to the Federal Acquisition Regulation (FAR) (48 CFR chapter 1, parts 1-99).

AUTHORITY: Sec. 205(c), 63 Stat. 390; 40 U.S.C. 486(c).

SOURCE: 29 FR 13257, Sept. 24, 1964, unless otherwise noted.

§ 101-31.000 Scope of part.

This part prescribes policy, guidelines, and procedures related to inspection, testing, and grading of supplies or services.

Subpart 101-31.1 [Reserved]

Subpart 101-31.2—Private Inspection, Testing, and Grading Services

§ 101-31.200 Cross-reference to the Federal Acquisition Regulation (FAR) (48 CFR chapter 1, parts 1-99).

For guidance see Federal Acquisition Regulation (e.g., Subpart 7.5, and parts 37 and 46) (48 CFR Subpart 7.5, and parts 37 and 46).

[64 FR 34734, June 29, 1999]

PART 101-32 [RESERVED]

PART 101-33—PUBLIC UTILITIES

Sec.

101-33.000 Scope of part.

Subpart 101-33.0—General Provisions

101-33.001 Definitions.

101-33.002 Applicability.

101-33.003 Submission of information.

Subpart 101-33.1—Utilization and Conservation of Utility Services

101-33.101 Surveys and recommendations.

101-33.102 Advice and assistance.

Subpart 101-33.2—Negotiation and Representation Involving Utility Services

101-33.201 Negotiations with utility suppliers.

101-33.202 Proceedings before regulatory bodies.

Subpart 101-33.3—Capital Credits

101-33.301 General.

101-33.302 Definitions.

101-33.302-1 Capital credits.

101-33.302-2 REA-financed cooperative.

101-33.303 Responsibility for handling capital credit notifications.

101-33.304 Disposition of capital credit retirements.

101-33.305 Cost-reimbursement type contracts.

101-33.306 Other provisions.

Subparts 101-33.4—101-33.48 [Reserved]

Subpart 101-33.49—Forms and Reports [Reserved]

AUTHORITY: 40 U.S.C. 486(c).

SOURCE: 29 FR 13258, Sept. 24, 1964, unless otherwise noted. Redesignated at 43 FR 27191, June 23, 1978.

§ 101-33.000 Scope of part.

(a) This part prescribes policies and methods governing the economical and efficient management of public utility services by executive agencies within the United States and its insular possessions.

(b) For more information on the management of public utility services, see 41 CFR parts 102-71 through 102-82. To the extent that any policy statements in this part are inconsistent with the policy statements in 41 CFR parts 102-71 through 102-82, the policy statements in 41 CFR parts 102-71 through 102-82 are controlling.

[29 FR 13258, Sept. 24, 1964. Redesignated at 43 FR 27191, June 23, 1978, as amended at 66 FR 5359, Jan. 18, 2001]

Subpart 101-33.0—General Provisions

§ 101-33.001 Definitions.

As used in this part:

(a) *Public utility services* includes without limitation all utility services (except telecommunications services), such as electricity, gas, steam, water, and sewerage procured from a public utility supplier, and facilities for the supply of such services.

(b) Other terms which are defined in the Federal Property and Administrative Services Act of 1949, 63 Stat. 377, as amended, hereinafter sometimes referred to as the “Property Act,” shall have the meanings given to them in such Act.

§ 101-33.002 Applicability.

The provisions of this part 101-33 apply to all Federal agencies to the extent specified in the Property Act, or other law, except in those instances where specific exemptions are approved by GSA, and except as hereinafter provided:

(a) The “Statement of Areas of Understanding between the Department of Defense and the General Services Administration in the Matter of Procurement of Utility Services,” as amended (15 FR 8227 and 22 FR 871), shall govern the applicability of this part 101-33 to the Department of Defense.

(b) The provisions of this part 101-33 do not apply to the production, distribution, or sale of utility services by a Federal Agency.

(c) GSA will, upon request, furnish the services provided for in this part 101-33 to any other Federal agency, mixed-ownership corporation, the District of Columbia, the Senate, the House of Representatives, and the Architect of the Capitol and any activity under his direction.

(d) The provisions of this part 101-33 do not apply to the procurement of natural gas from source suppliers; i.e., suppliers other than a local public utility. Procurement of natural gas from source suppliers is covered in §101-26.602-5.

[29 FR 13258, Sept. 24, 1964. Redesignated at 43 FR 27191, June 23, 1978, and amended at 57 FR 21895, May 26, 1992]

§ 101-33.003 Submission of information.

All information required under this part 101-33, except where otherwise specified, shall be addressed to the General Services Administration, Public Buildings Service, Public Utilities Division (PPU), Washington, DC 20405.

[57 FR 21896, May 26, 1992]

Subpart 101-33.1—Utilization and Conservation of Utility Services

§ 101-33.101 Surveys and recommendations.

GSA, in coordination with the agency involved, will from time to time survey executive agency requirements for, and utilization and conservation of, utility services and facilities and, with due regard to the program activities of the agency involved, will make such recommendations for improvements as may be deemed advantageous to the Government in terms of economy, efficiency, or service. Executive agencies shall carry out such recommendations.

§ 101-33.102 Advice and assistance.

GSA, upon request of the agency involved, will provide advice and assistance to executive agencies regarding utilization and conservation of utility services and facilities.

Subpart 101-33.2—Negotiation and Representation Involving Utility Services

§ 101-33.201 Negotiations with utility suppliers.

GSA, in behalf of executive agencies as utility consumers, will conduct negotiations with utility suppliers; and, where prior negotiation has failed or is not feasible and where circumstances warrant, will institute such formal or informal action, as may be deemed advisable, before Federal and State regulatory bodies to contest the level, structure, or applicability of rates or service terms of utility suppliers.

§ 101-33.202 Proceedings before regulatory bodies.

Pursuant to the provisions of section 201(a)(4) of the Property Act, executive

Federal Property Management Regulations

§ 101-33.304

agencies shall refer to GSA for consideration, all complaints and petitions involving public utility rates or services proposed to be brought before Federal and State regulatory bodies. Executive agencies seeking intervention authority shall submit their requests to GSA in writing. GSA will determine whether it will handle the proceedings, in cooperation with other interested agencies, or delegate the handling of the proceeding to the referring agencies, depending on which course of action is deemed to be in the best interest of the Government. Agencies delegated intervention authority shall be responsible for representing the interests of all Federal executive agencies in the utility's service jurisdiction, and shall give a diligent effort to identify those interests. To the extent that there is a divergence of interest between the agency receiving the delegation and other agencies served by the utility, the delegated agency shall promptly notify GSA of the situation. After completion of a case, the delegated agency shall provide a report that describes the results of the intervention effort; the report will include a copy of the Public Utility Commission's decision, a summary of the rates requested and approved by the Commission, an estimate of the impact on Federal executive agencies, and a discussion of the central issues of the case. The final report shall be provided to GSA within 90 days of the issuance of the Commission's decision.

[56 FR 21311, May 8, 1991]

Subpart 101-33.3—Capital Credits

SOURCE: 36 FR 13687, July 23, 1971, unless otherwise noted. Redesignated at 43 FR 27191, June 23, 1978.

§ 101-33.301 General.

Some Federal agencies procure public utility services from Rural Electrification Administration (REA)-financed cooperatives. Since REA-financed cooperatives are nonprofit organizations, any amount paid by participating agencies (also referred to as patrons) in excess of cost of services (usually referred to as operating mar-

gins) is treated as capital furnished by such patrons. Operating margins are determined annually on a patronage basis and credited to a capital account for each patron. The cooperative returns the share of the net income credited to agencies on a revolving basis by cash payments or deductions in current service bills when the cooperative's board of directors determines that such a retirement will not impair the cooperative's financial condition.

§ 101-33.302 Definitions.

As used in this subpart 101-33.3, the following terms shall have the meanings stated below.

§ 101-33.302-1 Capital credits.

Capital credits are patronage dividends derived from amounts paid by patrons in excess of cost of services. Agencies are informed of their share of the capital credit, if any, by written notices of allocation issued by REA-financed cooperatives.

§ 101-33.302-2 REA-financed cooperative.

An REA-financed cooperative is a nonprofit organization that furnishes electric or telephone services to customers, including Federal agencies.

§ 101-33.303 Responsibility for handling capital credit notifications.

Contracting and procurement officers and other employees of Federal agencies shall forward promptly any capital credit notifications to their finance officer or other accountable official. The accountable official shall retain the notification in the official files of the agency.

§ 101-33.304 Disposition of capital credit retirements.

When capital credits are (a) settled by payment to the Government or (b) offset on billings to the Government, the amount received shall be deposited in the Department of the Treasury as miscellaneous receipts, or treated as a cost reduction, as appropriate.

§ 101-33.305

§ 101-33.305 Cost-reimbursement type contracts.

Federal agencies having cost-reimbursement type contracts with contractors who purchase electric or telephone service from cooperatives shall include in their contracts arrangements for handling capital credits. The applicable portion of any capital credit retirement relating to any allowable cost received by or accruing to a cost-reimbursement type contractor shall be credited to the Government either as a cost reduction or by cash refund, as appropriate. (See § 1-15.201-5.)

41 CFR Ch. 101 (7-1-01 Edition)

§ 101-33.306 Other provisions.

(a) Capital credits shall not be waived by contract or in any other way.

(b) The right to any capital credit is not lost by reason of subsequent discontinuance of service.

**Subparts 101-33.4—101-33.48
[Reserved]**

**Subpart 101-33.49—Forms and
Reports [Reserved]**

PART 101-34 [RESERVED]

APPENDIX TO SUBCHAPTER E—
TEMPORARY REGULATIONS [RESERVED]

SUBCHAPTER F—MANAGEMENT AND USE OF TELECOMMUNICATIONS RESOURCES

EFFECTIVE DATE NOTE: At 61 FR 41003, Aug. 7, 1996, subchapter F, consisting of part 101-35, was added, effective Aug. 8, 1996 through Aug. 8, 1998. At 63 FR 27682, May 20, 1998, the effective date was extended through Aug. 8, 1999. At 64 FR 38588, July 19, 1999, the effective date was further extended through Aug. 8, 2000. At 65 FR 48393, Aug. 8, 2000, the effective date was further extended through Aug. 8, 2001.

PART 101-35—TELECOMMUNICATIONS MANAGEMENT POLICY

Subpart 101-35.0—General Provisions

Sec.

101-35.0 Scope of part.

101-35.1—101-35.4 [Reserved]

101-35.5 Definitions.

Subpart 101-35.1—Use of Government Telephone Systems

101-35.100 Scope of subpart.

Subpart 101-35.2—Authorized Use of Long Distance Telephone Services

101-35.200 Scope of subpart.

101-35.201 Authorized use of long distance telephone services.

101-35.202 Collection for unauthorized use.

Subpart 101-35.3—The Mandatory FTS Long Distance Network

101-35.300 Scope of subpart.

101-35.301 The mandatory FTS long distance network.

101-35.301-1 General.

101-35.301-2 Policies.

101-35.301-3 Procedures.

Subpart 101-35.4—Consolidated Local Telecommunications Service

101-35.400 Scope of subpart.

101-35.401 General.

101-35.402 Policies.

Subpart 101-35.5—National Security and Emergency Preparedness (NSEP)

101-35.500 Scope of subpart.

101-35.501 General.

101-35.502 Policy.

101-35.503 Procedures.

Subpart 101-35.6—Delegation of GSA's Multiyear Contracting Authority for Telecommunications Resources

101-35.600 Scope of subpart.

101-35.601 General.

Subpart 101-35.7—Network Address Registration

101-35.705 What does this subpart contain?

101-35.710 What registration services are available through GSA?

101-35.715 Who should I contact for more information or to register?

101-35.720 Is there a fee for these services?

101-35.725 How and where do I pay these fees?

AUTHORITY: 40 U.S.C. 486(c) and 1424(b). Subpart 101-35.7 also issued under authority of 31 U.S.C. 9701.

SOURCE: 61 FR 41003, Aug. 7, 1996, unless otherwise noted.

Subpart 101-35.0—General Provisions

§ 101-35.0 Scope of part.

This part prescribes policies and procedures about telecommunications resources.

§§ 101-35.1—101-35.4 [Reserved]

§ 101-35.5 Definitions.

Consolidated local telecommunication service means local telecommunications service to all Federal agencies located in a building, complex, or geographical area.

Executive agency means any executive department or independent establishment in the executive branch of the Government, including any wholly owned Government corporation (see 40 U.S.C. 472(a)).

Federal Telecommunications System (FTS) means the umbrella of local and long distance telecommunications services, including FTS2000 long distance telecommunications services, provided, operated, managed, or maintained by GSA for the common use of all Federal agencies and other authorized users.

Interoperability means the ability of telecommunications resources to provide services to and accept services from other telecommunications resources and to use the services so exchanged to enable them to operate effectively together.

Long distance telephone service means any service or facility purchased with Government funds for completing telephone calls outside of the local service area.

National security and emergency preparedness (NSEP) means those physical, technical, and administrative characteristics of telecommunications systems that will ensure a prescribed level of survivability in times of national or other emergency mission needs of the Government entities that use them.

Subpart 101-35.1—Use of Government Telephone Systems

§ 101-35.100 Scope of subpart.

This subpart discusses the policies and procedures for using long distance telephone service.

Subpart 101-35.2—Authorized Use of Long Distance Telephone Services

§ 101-35.200 Scope of subpart.

This subpart discusses authorized use of telephone systems and facilities provided, paid for, or reimbursed by the Federal Government.

§ 101-35.201 Authorized use of long distance telephone services.

(a) *Scope.* This section describes policies and procedures for the use of Government-provided and commercial long distance telephone service paid for by the Government.

(b) *General.* Agencies should be familiar with the Office of Management and Budget (OMB) “Guidance on the Privacy Act Implications of Call Detail Programs to Manage Employees’ Use of the Government’s Telecommunications Systems” (52 FR 12990, April 20, 1987).

(c) *Policy.* (1) Telephone calls placed over Government-provided and commercial long distance systems that will be paid for or reimbursed by the Gov-

ernment, shall be used to conduct official business only.

(2) To the maximum extent practicable, Federal employees shall place calls on Government-provided long distance telephone systems and services instead of using commercial toll services.

(3) In accordance with 5 CFR 2635.704, the following practices are prohibited and a willful violation may result in criminal, civil, or administrative action, including suspension or dismissal:

(i) Use of any Government system or service, or any other telephone service, where the Government pays the cost of the long distance call, for other than official business, except emergency calls and calls the agency determines are necessary in the interest of the Government.

(ii) Making an unauthorized long distance telephone call with the intent to later reimburse the Government.

(iii) Unauthorized use of telephone call detail data.

(d) *Procedures.* Official business calls may include emergency calls and other calls the agency determines are necessary in the interest of the Government.

(1) Telephone calls may properly be authorized when they—

(i) Do not adversely affect the performance of official duties by the employee or the employee’s organization;

(ii) Are of reasonable duration and frequency; and

(iii) Could not reasonably have been made at another time; or

(iv) Are provided for in a collective bargaining agreement that is consistent with this part.

(2) Personal long distance calls that must be made during working hours may be made over the commercial long distance network if consistent with the criteria in paragraph (d)(1) of this section and are:

(i) Charged to the employee’s home phone number or other non-Government number (third-number call);

(ii) Made to an 800 toll-free number;

(iii) Charged to the called party if a non-Government number (collect call); or

(iv) Charged to a personal telephone credit card.

Federal Property Management Regulations

§ 101-35.301-2

(3) Agencies shall issue directives on using telephone facilities and services. Agencies' contractor-operated facilities shall be covered by these directives. The directives may provide further definition of calls necessary in the interest of the Government and shall include procedures for collection and reimbursement for unauthorized calls.

§ 101-35.202 Collection for unauthorized use.

(a) Agencies shall collect for any unauthorized calls if it is cost-effective to do so. Reimbursing the Government for unauthorized calls does not exempt an employee from appropriate administrative, civil, or criminal action.

(b) Agency collections shall include—

(1) The value of the call, computed on the basis of commercial long distance rates rounded to the nearest dollar; and

(2) An additional amount rounded to the nearest dollar to cover the administrative costs of determining that the call was unauthorized and processing the collection.

Subpart 101-35.3—The Mandatory FTS Long Distance Network

§ 101-35.300 Scope of subpart.

This subpart describes the GSA FTS program and contracts that are mandatory-for-use by agencies.

§ 101-35.301 The mandatory FTS long distance network.

§ 101-35.301-1 General.

(a) In accordance with section 629 of Public Law 104-52, (109 Stat. 468, 504, November 19, 1995), executive agencies must use the FTS long distance network.

(b) GSA will grant exceptions to the use of the FTS long distance network when:

(1) The agency's procurement requirements are unique and cannot be satisfied by the FTS long distance network; and

(2) The agency procurement would be cost-effective and would not adversely affect the cost-effectiveness of the FTS long distance network.

(c) The FTS long distance network provides Federal agencies modern up-

to-date intercity telecommunications services over the life of the program. GSA will enhance existing services and add features to the FTS long distance network to maintain technologically current services and to improve services to user agencies. GSA will make service improvements in accordance with agencies' needs, contract provisions, governing regulations and statutes.

(d) As used in this FPMR, the terms intercity and long distance have the same meaning.

§ 101-35.301-2 Policies.

(a) Executive agencies shall use the FTS long distance network to satisfy intercity telecommunications requirements within the United States, Guam, Puerto Rico, or the Virgin Islands for requirements which are within the scope of the FTS long distance network voice, data, and video services as such services become available unless:

(1) The agency requests and obtains from GSA an exception to the use of the FTS long distance network based on a GSA determination that:

(i) The agency's procurement requirements are unique and cannot be satisfied by the FTS long distance network; and

(ii) The agency procurement would be cost-effective and would not adversely affect the cost-effectiveness of the FTS long distance network;

(2) The agency requests and obtains from GSA an interim exception to the use of the FTS long distance network based on an established date for transition to the FTS long distance network; or

(3) An exception to the use of the FTS long distance network for the agency is otherwise provided by law.

(b) Unless any of the exceptions listed in paragraph (a) of this section apply to the procurement, and when overall procurement requirements include any agency long distance telecommunications requirements which are within the scope of FTS services, executive agencies shall require offerors in new awards to satisfy those requirements by using the Government furnished services of the FTS long distance network as such services become available.

(c) For ease of determining and evaluating Government costs, executive agencies also shall require offerors to unbundle FTS long distance services in their offers by separately describing and pricing the FTS services that satisfy Government requirements. However, the agency solicitation may prescribe an expected solution for the use of the FTS long distance network. Offerors would then be required to separately price the Government-furnished services of FTS only if their offers show a different use of FTS than the Government's expected solution.

(d) Notwithstanding paragraphs (a) and (b) of this section, agencies may continue to use intercity telecommunications services and facilities provided under contracts previously authorized and awarded without obtaining an exception to the use of the FTS long distance network. However, agencies shall use available FTS long distance services that can satisfy their procurement requirements upon expiration of such contracts. Before exercising renewal options under existing contracts that will result in the provision of intercity telecommunications services, agencies shall obtain an interim exception to the use of the FTS long distance network. This interim exception will allow GSA and the agencies to plan an orderly transition to the FTS long distance network.

(e) In planning for transition to the FTS long distance network, agencies shall be responsible for determining customer premises equipment requirements to achieve efficient interfaces with the type of FTS services needed. However, agencies shall avoid duplicating FTS services. Agencies shall avoid incorporating inherently intercity features (i.e., features that can be provided only as part of an intercity network) of the FTS long distance network in agency networks. An exception to the use of the FTS long distance network is hereby provided to agencies with requirements for non-inherently intercity features to satisfy such features within a local network.

§ 101-35.301-3 Procedures.

(a) GSA will provide assistance in understanding and pricing the services available from the FTS long distance

network and in developing plans for transition to the FTS long distance network. For assistance and information concerning the FTS network, agencies should contact the General Services Administration, Federal Telecommunications Service (T), 7980 Boeing Court, 4th Floor, Vienna VA, 22182-3988.

(b) Agencies seeking an exception to the use of the FTS long distance network are responsible for documenting their case. A complete agency request for an exception to the use of the FTS long distance network shall establish to the satisfaction of GSA that:

(1) The agency's procurement requirements are unique and cannot be satisfied by the FTS long distance network;

(2) The agency's procurement would be cost-effective; and

(3) The agency's procurement would not adversely affect the cost-effectiveness of the FTS long distance network. (The rebuttable presumption is that, if an agency procurement requirement is unique and the resultant procurement would be cost-effective, the agency procurement would not adversely affect the cost-effectiveness of the FTS long distance network.)

(c) An agency request for an interim exception to the use of the FTS long distance network shall be based on a GSA established date for transition of agency requirements to the FTS long distance network.

(d) Any agency exception request shall be sent to the General Services Administration/Federal Telecommunications Service (T).

(e) Agencies may conduct procurements for long distance telecommunications services and facilities without prior approval of GSA when the agency's requirements are within the scope of an exception to the use of the FTS long distance network provided by GSA.

(f) An agency may appeal a GSA denial of a request for an exception to the Office of Management and Budget (OMB).

(g) If an agency has a requirement for long distance telecommunications within the United States, Guam, Puerto Rico, or the Virgin Islands that may

Federal Property Management Regulations

§ 101-35.503

be outside the scope of FTS, the requirement shall be submitted to GSA/T prior to initiating acquisition action. An exception to the mandatory use of the FTS long distance network will be given if GSA determines the service cannot be provided by the FTS.

Subpart 101-35.4—Consolidated Local Telecommunications Service

§ 101-35.400 Scope of subpart.

This subpart discusses local telecommunications facilities and services provided to executive agencies by GSA and other agencies.

§ 101-35.401 General.

Consolidated local telecommunications service is available in most buildings occupied by concentrations of Federal employees. Local telecommunications includes any access services which provide, for a monthly fee, electronic connectivity to a larger telecommunications network and those support services which provide for the acquisition, operation and management of attached systems. Information on the use of consolidated local telecommunications services may be obtained from: GSA, Federal Telecommunications Service, Office of Regional Services (TR), 1730 M Street, NW., Suite 200, Washington, DC 20036.

§ 101-35.402 Policies.

(a) All executive agencies shall evaluate sharing Government owned or contracted local telecommunications facilities and services. Evaluation criteria and associated decisions must be documented as appropriate.

(b) Executive agencies receiving local telecommunications services from another agency, e.g., a GSA consolidated switch, must acknowledge their shared responsibility to that community of agencies in exchange for those services. Such a community shall be considered a telecommunications “Shared Resource Community.” The agency primarily responsible for providing telecommunications service(s) to members of this community shall be the “Lead Agency.” Lead agencies must acknowl-

edge their responsibility(s) to provide services until an alternative arrangement has been coordinated with the community. Different agencies may take the lead in providing different services. Memoranda of Agreement will identify responsibilities and cost-recovery mechanisms.

(c) GSA charges to agencies for consolidated local telecommunications service will cover expenses for installation, changes in service, a common distributable charge, and termination.

Subpart 101-35.5—National Security and Emergency Preparedness (NSEP)

§ 101-35.500 Scope of subpart.

This subpart discusses NSEP services and assistance provided by GSA to executive agencies.

§ 101-35.501 General.

Executive Order 12472 (49 FR 13471, 3 CFR, 1984 Comp., p. 193), requires that GSA ensure that the NSEP requirements of agencies are met. GSA incorporates NSEP safeguards and support features in networks and services it provides for agencies. GSA also provides emergency telecommunications for the special needs of agencies and helps agencies plan, obtain, and maintain continuity of telecommunications during wartime and non-wartime emergencies.

§ 101-35.502 Policy.

Agencies shall use available GSA telecommunications systems and services to meet their NSEP requirements.

§ 101-35.503 Procedures.

Before acquiring services or facilities to meet special NSEP requirements, agencies shall review GSA-provided services. Agencies shall coordinate their special NSEP requirements with: General Services Administration, Federal Telecommunications Service, Office of Service Delivery, NSEP Center (TOS), 18th & F Streets, NW., Washington, DC 20405.

Subpart 101-35.6—Delegation of GSA’s Multiyear Contracting Authority for Telecommunications Resources

§ 101-35.600 Scope of subpart.

This subpart discusses the delegation of GSA’s multiyear contracting authority to executive agencies.

§ 101-35.601 General.

Executive agencies are authorized to enter into multiyear contracts for telecommunications resources subject to the following conditions:

- (a) The agency shall notify GSA/T prior to using GSA’s multiyear contracting authority.
- (b) The contract life including options, shall not exceed 10 years.
- (c) Agencies shall comply with OMB budget and accounting procedures relating to appropriated funds.

Subpart 101-35.7—Network Address Registration

SOURCE: 64 FR 32198, June 16, 1999, unless otherwise noted.

§ 101-35.705 What does this subpart contain?

This subpart addresses registration services provided by GSA to Government agencies and the public.

§ 101-35.710 What registration services are available through GSA?

(a) The National Institute of Standards and Technology (NIST), Department of Commerce, has designated GSA as the Government Open Systems Interconnection Profile (GOSIP) Address Registration Authority for unique naming assignments of X.400 Private Management Domains (PRMD), X.500 Organizational Units (OU), and Network Service Access Point (NSAP) Administrative Authority Identifiers (AAI). GOSIP registration is limited to Government agencies, with the exception of NSAP AAIs, which may be used by commercial organizations to identify private asynchronous transfer mode (ATM) networks.

(b) For purposes of global interoperability, GSA will operate an X.500/LDAP Directory Service at the

“C=US” level and at the “O=U.S. Government” level. Federal agencies may link operational directories to the “O=U.S. Government” level and commercial organizations may link to the “C=US” level in accordance with the fees set forth in §101-35.704.

(c) The National Science Foundation (NSF) has delegated to GSA the authority to manage and administer the .GOV Internet domain. GSA provides second-level domain registrations in the GOV domain (*e.g.*, <Agency>.gov). Similarly, GSA provides third-level domain registrations in the “fed.us” domain under authority of the Internet Assigned Numbers Authority (IANA). Internet registration services are limited to Federal, State, and local Government organizations. GSA is not responsible for and will not charge fees for any further delegation of a domain name assigned to an agency. For example, the U.S. Department of the Treasury has registered “ustreas.gov,” but registrations such as “irs.ustreas.gov” would be the responsibility of the domain manager for Treasury.

§ 101-35.715 Who should I contact for more information or to register?

Individuals or organizations that want to register or would like more information should contact the registration officials at GSA by sending an e-mail message to *registration@fed.gov* or by using the Web site at *http://www.nic.gov*.

§ 101-35.720 Is there a fee for these services?

GSA will assess Government agencies and commercial organizations nominal fees to cover the cost of registration and other services as listed in the table in this section. The fees are based on anticipated costs for providing the services and are consistent with industry charges. The table follows:

Service	Setup	Recurring (annual)
(a) Network Naming and Address Registration (GOSIP)	\$1,000.00	\$500.00
(b) Governmentwide Directory Operation (X.500/LDAP)	1,000.00	500.00
(c) Internet Domain Name Registration	250.00	50.00

Federal Property Management Regulations

§ 101-35.725

NOTE TO §101-35.720: Setup fees may be waived at the discretion of GSA. When levied, setup fees include the annual fee for 1 year.

§ 101-35.725 How and where do I pay these fees?

GSA will invoice registrants according to the fee schedule in §101-35.720.

Government registrations must be paid by Government credit card. Commercial organizations are encouraged to pay by credit card. All other payments should be made to: GSA Registration Services, 1800 F Street, NW., Suite G-222, Washington, DC 20405.

SUBCHAPTER G—AVIATION, TRANSPORTATION, AND MOTOR VEHICLES

PART 101-37—GOVERNMENT AVIATION ADMINISTRATION AND COORDINATION

Sec.

101-37.000 Scope of part.

Subpart 101-37.1—Definitions

101-37.100 Definitions.

Subpart 101-37.2—Accounting for Aircraft Costs

101-37.200 General.
101-37.201 Standard aircraft program cost elements.
101-37.202 Policy.
101-37.203 [Reserved]
101-37.204 Operations cost recovery methods.
101-37.205 Aircraft program cost effectiveness.

Subpart 101-37.3—Cost Comparisons for Acquiring and Using Aircraft

101-37.300 General.
101-37.301 Applicability.
101-37.302—101-37.303 [Reserved]
101-37.304 Variable cost rate.
101-37.305 Acquisition and management.

Subpart 101-37.4—Use of Government-Owned and -Operated Aircraft

101-37.400 General.
101-37.401 [Reserved]
101-37.402 Policy.
101-37.403 Reimbursement for the use of Government aircraft.
101-37.404 Approving the use of Government aircraft for transportation of passengers.
101-37.405 Approving travel on Government aircraft.
101-37.406 Justification of the use of Government aircraft for transportation of passengers.
101-37.407 Documentation.
101-37.408 Reporting travel by senior Federal officials.

Subpart 101-37.5—Management Information Systems (MIS)

101-37.500 General.
101-37.501 [Reserved]
101-37.502 GSA MIS responsibilities.
101-37.503 Reporting responsibilities.
101-37.504 Reports.

101-37.505 Aircraft used for sensitive missions.

101-37.506 Reporting requirements for law enforcement, national defense, or interdiction mission aircraft.

Subpart 101-37.6—Management, Use, and Disposal of Government Aircraft Parts

101-37.600 What does this subpart do?
101-37.601 What responsibilities does the owning/operating agency have in the management and use of Government aircraft parts?
101-37.602 Are there special requirements in the management, use, and disposal of military Flight Safety Critical Aircraft Parts (FSCAP)?
101-37.603 What are the owning/operating agency's responsibilities in reporting excess Government aircraft parts?
101-37.604 What are the procedures for transferring and donating excess and surplus Government aircraft parts?
101-37.605 What are the receiving agency's responsibilities in the transfer and donation of excess and surplus Government aircraft parts?
101-37.606 What are the GSA approving official's responsibilities in transferring and donating excess and surplus Government aircraft parts?
101-37.607 What are the State Agency's responsibilities in the donation of surplus Government aircraft parts?
101-37.608 What are the responsibilities of the Federal agency conducting the sale of Government aircraft parts?
101-37.609 What are the procedures for mutilating unsalvageable aircraft parts?
101-37.610 Are there special procedures for the exchange/sale of Government aircraft parts?

Subparts 101-37.7—101-37.10 [Reserved]

Subpart 101-37.11—Aircraft Accident and Incident Reporting and Investigation

101-37.1100 What are my general responsibilities for aircraft accident and incident reporting and investigation?
101-37.1101 What aircraft accident and incident response planning must I do?
101-37.1102 When must I give initial notification of an aircraft accident, incident, or overdue aircraft?
101-37.1103 What information must I give in an initial notification of an aircraft accident, incident, or overdue aircraft?
101-37.1104 What are my responsibilities for preserving aircraft wreckage, cargo,

Federal Property Management Regulations

§ 101-37.100

- mail, and records resulting from aircraft accidents and incidents?
- 101-37.1105 What must I report regarding an aircraft accident, incident, or overdue aircraft?
- 101-37.1106 What must I do when the NTSB investigates an accident or incident involving my aircraft?
- 101-37.1107 What must I do if I observe a condition, act, maintenance problem, or circumstance that has the potential to cause an aviation related mishap?
- 101-37.1108 Why is it important that I be provided aircraft accident/incident related guidance in the form of this subpart, in addition to that found in 49 CFR parts 830 and 831?
- 101-37.1109 What training must I have to participate in an NTSB investigation?

Subparts 101-37.12—Federal Agency Aviation Safety Program

- 101-37.1200 General.
- 101-37.1201 Applicability.
- 101-37.1202 Agency aviation safety responsibilities.
- 101-37.1203 Aviation safety manager qualifications.
- 101-37.1204 Program responsibilities.
- 101-37.1205 Program elements.
- 101-37.1206 Aviation safety council.
- 101-37.1207 Inspections and evaluations.
- 101-37.1208 Hazard reporting.
- 101-37.1209 Aircraft accident and incident investigation and reporting.
- 101-37.1210 Education and training.
- 101-37.1211 Aviation protective equipment.
- 101-37.1212 Aircrew qualification and certification.
- 101-37.1213 Aircraft accident and incident database.
- 101-37.1214 Aviation safety awards program.

Subpart 101-37.13 [Reserved]

Subpart 101-37.14—Forms

- 101-37.1400 General.
- 101-37.1401 GSA forms availability.

AUTHORITY: Sec. 205(c), 63 Stat. 390; 40 U.S.C. 486(c); the Budget and Accounting Act of 1921, as amended; the Budget and Accounting Procedures Act of 1950, as amended; Reorganization Plan No. 2 of 1970; Executive Order 11541; and OMB Circular No. A-126 (Revised May 22, 1992).

SOURCE: 56 FR 5356, Feb. 11, 1991, unless otherwise noted.

§ 101-37.000 Scope of part.

(a) The provisions of this part prescribe policies and procedures and make recommendations for executive agencies governing the efficient and ef-

fective management and utilization of Government-owned, leased, chartered and rented aircraft and related support services.

(b) Agencies are responsible for establishing clear accountability for aircraft management at a senior management level.

[57 FR 48329, Oct. 23, 1992]

Subpart 101-37.1—Definitions

§ 101-37.100 Definitions.

In part 101-37, the following definitions apply:

Acquisition date means the date the agency acquired the asset.

Acquisition value means the value initially recorded on agency property records and/or accounting records at the time of acquisition. If the aircraft is acquired through an interagency transfer, the acquisition value is the greater of the aircraft net book value plus the cost of returning the aircraft to an airworthy, mission ready condition or the commercial retail value of that aircraft in average condition. If it is a military aircraft without a commercial equivalent, the acquisition value is equal to the scrap value plus the cost of returning the aircraft to an airworthy, mission ready condition.

Actual cost means all costs associated with the use and operation of an aircraft as specified in § 101-37.406(b).

Agency aircraft means an aircraft, excluding aircraft owned by the Armed Forces, which is: (1) owned and operated by any executive agency or entity thereof, or (2) exclusively leased, chartered, rented, bailed, contracted and operated by an executive agency.

Aircraft accident means an occurrence associated with the operation of an aircraft which takes place between the time any person boards the aircraft with the intention of flight and all such persons have disembarked, and in which any person suffers death or serious injury, or in which the aircraft received substantial damage.

Aircraft part means any part, component, system, or assembly primarily designated for aircraft.

Bailed aircraft means any aircraft borrowed by a department or agency from the Department of Defense (DOD),

State or local government, or other non-Federal entity.

Capital asset means any tangible property, including durable goods, equipment, buildings, facilities, installations, or land, which:

(1) Is leased to the Federal Government for a term of 5 or more years; or

(2) In the case of a new asset with an economic life of less than 5 years, is leased to the Federal Government for a term of 75 percent or more of the economic life of the asset; or

(3) Is built for the express purpose of being leased to the Federal Government; or

(4) Clearly has no alternative commercial use; e.g., special-purpose Government installation.

Charter aircraft means a one time procurement for aviation resources and associated services.

Civil aircraft means any aircraft other than a public aircraft.

Contract aircraft means aircraft procured for an agency's exclusive use for a specified period of time in accordance with the requirements of the Federal Acquisition Regulation (FAR) 48 CFR Chapter 1 or other applicable procurement regulations.

Criticality Code is the one-digit code assigned by Department of Defense to designate an aircraft part as a Flight Safety Critical Aircraft Part (FSCAP).

Deep cover aircraft means an agency aircraft that is utilized to gather information for law enforcement purposes. This aircraft does not display any agency markings. Although the registration filed with the Federal Aviation Administration (FAA) may indicate ownership by persons other than the owning or using agency, actual ownership will be maintained by the owning Federal agency.

Fatal injury means any injury which results in death within 30 days of the accident.

Fixed costs means the costs of operating aircraft that result from owning and supporting the aircraft and do not vary according to aircraft usage. For specific fixed aircraft program cost information, see § 101-37.201(b).

Flight Safety Critical Aircraft Part (FSCAP) means any aircraft part, assembly, or installation containing a critical characteristic whose failure,

malfunction, or absence could cause a catastrophic failure resulting in loss or serious damage to the aircraft or an uncommanded engine shut-down resulting in an unsafe condition.

Forfeited aircraft means an aircraft acquired by the Government either by summary process or by order of a court of competent jurisdiction pursuant to any law of the United States.

Full coach fare means a coach fare available to the general public between the day that the travel was planned and the day the travel occurred.

Government aircraft means any aircraft owned, leased, chartered or rented and operated by an executive agency.

Head of executive agency means the head of a Department, agency, bureau, or independent establishment in the executive branch, including any wholly owned Government corporation, or an official designated in writing to act on his or her behalf.

Incident means an occurrence other than an accident, associated with the operation of an aircraft, which affects or could affect the safety of operations.

Intelligence agencies refers to the following agencies or organizations within the intelligence community:

(1) Central Intelligence Agency;

(2) National Security Agency;

(3) Defense Intelligence Agency;

(4) Offices with the Department of Defense for the collection of specialized national foreign intelligence through reconnaissance programs;

(5) The Bureau of Intelligence and Research of the Department of State;

(6) Intelligence elements of the Army, Navy, Air Force, Marine Corps, Federal Bureau of Investigation, Drug Enforcement Administration, Department of the Treasury, and Department of Energy; and

(7) The staff elements of the Director of Central Intelligence.

Investigator-in-charge means the investigator who organizes, conducts, and controls the field phase of the investigation. This investigator shall assume responsibility for the supervision and coordination of all resources and of the activities of all personnel involved in the on-site investigation.

Federal Property Management Regulations

§ 101-37.100

Lease purchase aircraft means a leased aircraft for which the Government holds an option to purchase.

Leased aircraft means an aircraft that the Government has a contractual right to use for a specific period of time.

Loaned aircraft means an aircraft owned by a Department or independent office which is on loan to a State, cooperator, or other entity.

Military surplus aircraft part is an aircraft part that has been released as surplus by the military, even if subsequently resold by manufacturers, owner/operators, repair facilities, or any other parts supplier.

Mission requirements mean activities that constitute the discharge of an agency's official responsibilities. Such activities include, but are not limited to, the transport of troops and/or equipment, training, evacuation (including medical evacuation), intelligence and counter-narcotics activities, search and rescue, transportation of prisoners, use of defense attaché-controlled aircraft, aeronautical research and space and science applications, and other such activities. Mission requirements do not include official travel to give speeches, to attend conferences or meetings, or to make routine site visits. Routine site visits are customary or regular travel to a location for official purposes.

Net book value means the acquisition value plus the cost of capital improvements minus accumulated depreciation.

Non-operational aircraft means an owned, leased, lease purchased, or bailed aircraft that cannot be flown or operated by the owning or using agency for an extended period (6 months or more).

Official travel means travel for the purpose of mission requirements, required use travel, and other travel for the conduct of agency business.

Operational aircraft means an owned, leased, lease purchased, or bailed aircraft that is flown and operated or capable of being flown and operated by the owning or using agency.

Operator means any person who causes or authorizes the operation of an aircraft, such as the owner, lessee, or bailee of an aircraft.

Owned aircraft means aircraft registered to a Department or an independent agency in conformity with the regulations of the Federal Aviation Administration of the Department of Transportation (14 CFR Chapter 1, Part 47) or in conformity with appropriate military regulations.

Owning agency means any executive agency, including any wholly owned Government corporation, having accountability for owned aircraft. This term applies when an executive agency has authority to take possession of, assign, or reassign the aircraft regardless of which agency is the using agency.

Production approval holder is the holder of a Federal Aviation Administration Production Certificate (PC), Approved Production Inspection System (APIS), Parts Manufacturer Approval (PMA), or Technical Standard Order (TSO) who controls the design and quality of a product or part thereof, in accordance with Part 21 of the Federal Aviation Regulations (14 CFR 21.305).

Reasonably available means commercial airline or aircraft (including charter) is able to meet the traveler's departure and/or arrival requirements within a 24-hour period (unless the traveler demonstrates that extraordinary circumstances require a shorter period of time).

Rental aircraft means aviation resources or services procured through a standing ordering agreement which is a written instrument of understanding, negotiated between an agency, contracting activity, or contracting office and contractor that contains: (1) terms and clauses applying to future contracts (orders) between parties during its term, (2) a description, as specific as practicable, of supplies or services to be provided, and (3) methods for pricing, issuing, and delivering future orders.

Replacement means the process of acquiring property specifically to be used in place of property which is still needed but will no longer adequately perform all the tasks for which it was used.

Required use means use of a Government aircraft for the travel of an executive agency officer or employee to meet bona fide communications or security requirements of the agency or

exceptional scheduling requirements. An example of a bona fide communications requirement is having to maintain continuous 24-hour secure communications with the traveler. Bona fide security requirements include, but are not limited to, life threatening circumstances. Exceptional scheduling requirements include emergencies and other operational considerations which make commercial transportation unacceptable.

Residual value means the estimated value of an asset at the conclusion of its useful life, net of disposal costs. It is the dollar value below which the asset will not be depreciated. Residual value is established at the time of acquisition.

Seized aircraft means an aircraft that has been confiscated by the Federal Government either by summary process or by order of a court of competent jurisdiction pursuant to any law of the United States and whose care and custody will be the responsibility of the Federal Government until final ownership is determined by judicial process.

Senior executive branch official means civilian officials appointed by the President with the advice and consent of the Senate and civilian employees of the Executive Office of the President (EOP).

Senior Federal official means a person:

(1) Employed at a rate of pay specified in, or fixed according to, subchapter II of chapter 53 of title 5 of the United States Code;

(2) Employed in a position in an executive agency, including any independent agency, at a rate of pay payable for level I of the Executive Schedule or employed in the Executive Office of the President at a rate of pay payable for level II of the Executive Schedule;

(3) Employed in an executive agency position that is not referred to in paragraph (1) of this definition, (other than a position that is subject to pay adjustment under 37 U.S.C. 1009) and for which the basic rate of pay, exclusive of any locality-based pay adjustment under 5 U.S.C. 5304 (or any comparable adjustment pursuant to interim authority of the President), is equal to or greater than the rate of the basic pay

payable for the Senior Executive Service under 5 U.S.C. 5382; or

(4) Appointed by the President to a position under 3 U.S.C. 105(a)(2) (A), (B), or (C) or by the Vice President to a position under 3 U.S.C. 106(a)(1) (A), (B), or (C). Generally, a senior Federal official is employed by the White House or an executive agency, including an independent agency, at a rate of pay equal to or greater than the minimum rate of basic pay for the Senior Executive Service. The term senior Federal official does not include an active duty military officer.

Serious injury means any injury which: Requires hospitalization for more than 48 hours, commencing within 7 days from the date the injury was received; results in a fracture of any bone (except simple fractures of fingers, toes, or nose); causes severe hemorrhages, nerve, muscle, or tendon damage; involves any internal organ; or involves second- or third-degree burns, or any burns affecting more than 5 percent of the body surface.

Space available means travel using aircraft capacity, that is already scheduled for use for an official purpose, that would otherwise be unutilized. For the purposes of this part, space available travel is travel other than for the conduct of agency business.

Substantial damage means damage or failure which adversely affects the structural strength, performance, or flight characteristics of the aircraft, and which would normally require major repair or replacement of the affected component. Engine failure or damage limited to an engine if only one engine fails or is damaged, bent fairings or cowling, dented skin, small puncture holes in the skin or fabric, ground damage to rotor or propeller blades, and damage to landing gear, wheels, tires, flaps, engine accessories, brakes or wing tips are not considered "substantial damage."

Support service agreement means a preestablished agreement with a commercial vendor for specific aviation services.

Undercover aircraft means an owned, leased, lease purchased, or bailed aircraft that is utilized to gather information for law enforcement purposes. An

undercover aircraft does not display agency markings but is registered with the FAA to the owning agency.

Unsalvageable aircraft part is an aircraft part which cannot be restored to an airworthy condition due to its age, physical condition, a non-repairable defect, insufficient documentation, or non-conformance with applicable specifications. For additional information on disposition of such parts refer to FAA Advisory Circular No. 21-38, or other current applicable guidelines.

Useful life means the service life, in years, of the aircraft as estimated by the manufacturer or evidenced by historical performance. The useful life is established at the time of acquisition.

Using agency means an executive agency using aircraft for which it does not maintain ownership. This term applies when an agency obtains aircraft from any other executive agency on a temporary basis.

Variable costs means the costs of operating aircraft that vary depending on how much the aircraft are used. For specific variable aircraft program cost information see § 101-37.201(a).

[60 FR 3548, Jan. 18, 1995, as amended at 62 FR 43472, Aug. 14, 1997]

Subpart 101-37.2—Accounting for Aircraft Costs

SOURCE: 60 FR 3550, Jan. 18, 1995, unless otherwise noted.

§ 101-37.200 General.

The provisions of this subpart prescribe policies and procedures for accounting for aircraft costs. This subpart also prescribes provisions and procedures contained in OMB Circulars A-76 and A-126.

§ 101-37.201 Standard aircraft program cost elements.

The following cost elements will be used for the establishment of cost accounting systems and for reporting Government-owned and operated aircraft cost and utilization data to the Federal Aviation Management Information System (FAMIS) on GSA Form 3552.

(a) *Variable costs.* The variable costs of operating aircraft are those costs

that vary depending on how much the aircraft are used. The specific variable cost elements include:

(1) *Crew costs.* The crew costs which vary according to aircraft usage consist of travel expenses, particularly reimbursement of subsistence (i.e., per diem and miscellaneous expenses), overtime charges, and wages of crew members hired on an hourly or part-time basis.

(2) *Maintenance costs.* Unscheduled maintenance and maintenance scheduled on the basis of flying time vary with aircraft usage and, therefore, the associated costs are considered variable costs. In addition to the costs of normal maintenance activities, variable maintenance costs shall include aircraft refurbishment, such as painting and interior restoration, and costs of or allowances for performing overhauls and modifications required by service bulletins and airworthiness directives. If they wish, agencies may consider all of their maintenance costs as variable costs and account for them accordingly. Otherwise, certain maintenance costs will be considered fixed as described in paragraph (b) of this section. Variable maintenance costs include the costs of:

(i) *Maintenance labor.* This includes all labor (i.e., salaries and wages, benefits, travel, and training) expended by mechanics, technicians, and inspectors, exclusive of labor for engine overhaul, aircraft refurbishment, and/or repair of major components.

(ii) *Maintenance parts.* This includes cost of materials and parts consumed in aircraft maintenance and inspections, exclusive of materials and parts for engine overhaul, aircraft refurbishment, and/or repair of major components.

(iii) *Maintenance contracts.* This includes all contracted costs for unscheduled maintenance and for maintenance scheduled on a flying hour basis or based on the condition of the part or component.

(iv) *Engine overhaul, aircraft refurbishment, and major component repairs.* These are the materials and labor costs of overhauling engines, refurbishing aircraft, and/or repairing major aircraft components.

(A) In general, the flight hour cost is computed by dividing the costs for a period by the projected hours flown during the period. However, when computing the flight hour cost factor for this cost category, divide the total estimated cost for the activities in this category (e.g., overhaul, refurbishment, and major repairs) by the number of flight hours between these activities.

(B) Cost or reserve accounts for engine overhaul, aircraft refurbishment, and major component repairs may, at the agency's discretion, be identified and quantified separately for mission-pertinent information purposes. Reserve accounts are generally used when the aircraft program is funded through a working capital or revolving fund.

(3) *Fuel and other fluids.* The costs of the aviation gasoline, jet fuel, and other fluids (e.g., engine oil, hydraulic fluids, and water-methanol) consumed by aircraft.

(4) *Lease costs.* When the cost of leasing an aircraft is based on flight hours, the associated lease or rental costs are considered variable costs.

(5) *Landing and tie down fees.* Landing fees and tie down fees associated with aircraft usage are considered variable costs. Tie down fees for storing an aircraft at its base of operations should be considered part of operations overhead, a fixed cost.

(b) *Fixed costs.* The fixed costs of operating aircraft are those that result from owning and supporting the aircraft and do not vary according to aircraft usage. The specific fixed cost elements include:

(1) *Crew costs.* The crew costs which do not vary according to aircraft usage consist of salaries, benefits, and training costs. This includes the salaries, benefits, and training costs of crew members who also perform minimal aircraft maintenance. Also included in fixed crew costs are the costs of their charts, personal protective equipment, uniforms, and other personal equipment when the agency is authorized to purchase such items.

(2) *Maintenance costs.* This cost category includes maintenance and inspection activities which are scheduled on a calendar interval basis and take place regardless of whether or how

much an aircraft is flown. Agencies are encouraged to simplify their accounting systems and account for all maintenance costs as variable costs. However, if they wish, agencies may account for the following costs as fixed costs:

(i) *Maintenance labor.* This includes all projected labor expended by mechanics, technicians, and inspectors associated with maintenance scheduled on a calendar interval basis. This does not include variable maintenance labor or work on items having a retirement life or time between overhaul. This category also includes costs associated with nonallocated maintenance labor expenses; i.e., associated salaries, benefits, travel expenses, and training costs. These costs should be evenly allocated over the number of aircraft in the fleet.

(ii) *Maintenance parts.* This includes all parts and consumables used for maintenance scheduled on a calendar interval basis.

(iii) *Maintenance contracts.* This includes all contracted costs for maintenance or inspections scheduled on a calendar interval basis.

(3) *Lease costs.* When the cost of leasing an aircraft is based on a length of time (e.g., days, weeks, months, or years) and does not vary according to aircraft usage, the lease costs are considered fixed costs.

(4) *Operations overhead.* This includes all costs, not accounted for elsewhere, associated with direct management and support of the aircraft program. Examples of such costs include: personnel costs (salaries, benefits, travel, uniform allowances (when the agency is authorized to purchase such items), training, etc.) for management and administrative personnel directly responsible for the aircraft program; building and ground maintenance; janitorial services; lease or rent costs for hangars and administrative buildings and office space; communications and utilities costs; office supplies and equipment; maintenance and depreciation of support equipment; tie down fees for aircraft located on base; and miscellaneous operational support costs.

(5) *Administrative overhead.* These costs represent a prorated share of salaries, office supplies, and other expenses of fiscal, accounting, personnel, management, and similar common services performed outside the aircraft program but which support this program. For purposes of recovering the costs of operations, agencies should exercise their own judgment as to the extent to which aircraft users should bear the administrative overhead costs. Agencies may, for example, decide to charge non-agency users a higher proportion, not to exceed 100 percent of administrative overhead, than agency users if the agency has the authority to do so. If an aircraft is provided pursuant to an interagency agreement under the Economy Act of 1932 (31 U.S.C. 1535), the agency must charge based on the actual costs of the goods or services provided. For purposes of OMB Circular A-76 costs comparisons, agencies should compute the actual administrative costs that would be avoided if a decision is made to contract out the operation under study.

(6) *Self-insurance costs.* Aviation activity involves risks and potential casualty losses and liability claims. These risks are normally covered in the private sector by purchasing an insurance policy. The Government is self-insuring; the Treasury's General Fund is charged for casualty losses and/or liability claims resulting from accidents. For the purposes of analyses, Government managers will recognize a cost for "self-insurance" by developing a cost based on rates published by GSA's Aircraft Management Division.

(7) *Depreciation.* The cost or value of ownership. Aircraft have a finite useful economic or service life (useful life). Depreciation is the method used to spread the acquisition value, less residual value, over an asset's useful life. Although these costs are not direct outlays as is the case with most other aircraft costs, it is important to recognize them for analyses required by OMB and other cost comparison purposes and when replenishing a working capital fund by recovering the full cost of aircraft operations. Depreciation costs depend on aircraft acquisition or replacement costs, useful life, and residual or salvage value. To calculate

the cost of depreciation that shall be allocated to each year, subtract the residual value from the total of the acquisition cost plus any capital improvements and, then, divide by the estimated useful life of the asset.

(c) *Other costs.* There are certain other costs of the aircraft program which should be recorded but are not appropriate for inclusion in either the variable or fixed cost categories for the purposes of justifying aircraft use or recovering the cost of aircraft operations. These costs include:

(1) *Accident repair costs.* These costs include all parts, materials, equipment, and maintenance labor related to repairing accidental damage to airframes or aircraft equipment. Also included are all accident investigation costs.

(2) *Aircraft costs.* This is the basic aircraft inventory or asset account used as the basis for determining aircraft depreciation charges. These costs include the cost of acquiring aircraft and accessories, including transportation and initial installation. Also included are all costs required to bring aircraft and capitalized accessories up to fleet standards.

(3) *Cost of capital.* The cost of capital is the cost to the Government of acquiring the funds necessary for capital investments. The agency shall use the borrowing rate announced by the Department of the Treasury for bonds or notes whose maturities correspond to the manufacturer's suggested useful life or the remaining useful life of the asset.

§ 101-37.202 Policy.

Agencies shall maintain cost systems for their aircraft operations which will permit them to justify the use of Government aircraft in lieu of commercially available aircraft, or the use of one Government aircraft in lieu of another; recover the costs of operating Government aircraft when appropriate; determine the cost effectiveness of various aspects of their aircraft program; and conduct the cost comparisons to justify in-house operation of Government aircraft versus procurement of commercially available aircraft services. To accomplish these purposes,

§ 101-37.203

agencies must accumulate their aircraft program cost into the standard aircraft program cost elements specified in § 101-37.201.

§ 101-37.203 [Reserved]

§ 101-37.204 Operations cost recovery methods.

Under 31 U.S.C. 1535, and various acts appropriating funds or establishing working funds to operate aircraft, agencies are generally required to recover the costs of operating all aircraft in support of other agencies and other governments. Depending on the statutory authorities under which its aircraft were obtained or are operated, agencies may use either of two methods for establishing the rates charged for using their aircraft; full cost recovery rate or the variable cost recovery rate.

(a) The full cost recovery rate for an aircraft is the sum of the variable and fixed cost rates for that aircraft. The computation of the variable cost rate for an aircraft is described in § 101-37.304. The fixed cost recovery rate for an aircraft or aircraft type is computed as follows:

(1) Accumulate the fixed costs listed in § 101-37.201(b) that are directly attributable to the aircraft or aircraft type. These costs should be taken from the agency's accounting system.

(2) Adjust the total fixed cost for inflation and for any known upcoming cost changes to project the new fixed total costs. The inflation factor used should conform to the provisions of OMB Circular A-76.

(3) Allocate operations and administrative overhead costs to the aircraft based on the percentage of total aircraft program flying hours attributable to that aircraft or aircraft type.

(4) Compute a fixed cost recovery rate for the aircraft by dividing the sum of the projected directly attributable fixed costs, adjusted for inflation, from paragraph (a)(2) of this section and the allocated fixed costs from paragraph (a)(3) of this section by the annual flying hours projected for the aircraft.

(b) The variable cost recovery rate is the total variable cost rate of operating an aircraft described in § 101-

41 CFR Ch. 101 (7-1-01 Edition)

37.304. If an agency decides to base the charge for using its aircraft solely on this rate, it must recover the fixed costs of those aircraft from the appropriations which support the mission for which the procurement of the aircraft was justified. In such cases, the fixed cost recovery rate may be expressed on an annual, monthly, or flying hour basis.

(c) To compute the full cost recovery rate of using a Government aircraft for a trip, add the variable cost recovery rate for the aircraft or aircraft type to the corresponding fixed cost recovery rate and multiply this sum by the estimated number of flying hours for the trip using the proposed aircraft.

§ 101-37.205 Aircraft program cost effectiveness.

Although cost data are not the only measures of the effectiveness of an agency's aircraft program, they can be useful in identifying opportunities to reduce aircraft operational costs. These opportunities include changing maintenance practices, purchasing fuel at lower costs, and the replacement of old, inefficient aircraft with aircraft that are more fuel efficient and have lower operation and maintenance costs. The most common measures used to evaluate the cost effectiveness of various aspects of an aircraft program are expressed as the cost per flying hour or per passenger mile (one passenger flying one mile). These measures may be developed using the standard aircraft program cost elements (see § 101-37.201) and include, but are not limited to: maintenance costs/flying hours, fuel and other fluids/flying hours, and variable cost/passenger mile. GSA will coordinate the development of other specific cost-effectiveness measures with the appropriate Interagency Committee for Aviation Policy subcommittees (ICAP).

(a) *Maintenance costs per flying hour.* Maintenance costs per flying hour identifies on an aggregate basis relative cost effectiveness of maintenance alternatives. This measure is among those necessary to identify and justify procurement of less costly aircraft.

(b) *Fuel and other fluids cost per flying hour.* Fuel per flying hour identifies

the relative fuel efficiency of an individual aircraft. The measure identifies the requirement to replace inefficient engines or to eliminate fuel inefficient aircraft from the fleet.

(c) *Crew costs-fixed per flying hour.* When based on the total fixed crew costs and flying hours, can be used to determine the impact of crew utilization on overall operating costs; can also be used to compare crew utilization and salary levels among different agency or bureau aircraft programs.

(d) *Operations overhead per flying hour.* Operations overhead may be used on an aggregate basis (i.e., total operations overhead expenditures divided by hours flown) to compare the overhead activities in direct support of aircraft operations among agencies or bureaus. This factor can indicate excess overhead support costs.

(e) *Administrative overhead per flying hour.* Administrative overhead may be used on an aggregate basis (i.e., total administrative overhead divided by hours flown) to compare the level of administrative support to other agencies and bureaus.

Subpart 101-37.3—Cost Comparisons for Acquiring and Using Aircraft

SOURCE: 60 FR 3552, Jan. 18, 1995, unless otherwise noted.

§ 101-37.300 General.

The provisions of this subpart prescribe policies and procedures for conducting cost comparisons for the acquisition, use, or lease of aircraft. This subpart incorporates selected provisions of OMB Circulars A-76 and A-126.

§ 101-37.301 Applicability.

This subpart applies to all agencies in the executive branch of the Federal Government. It does not apply to the United States Postal Service, to the Government of the District of Columbia, or to non-Federal organizations receiving Federal loans, contracts, or grants.

§§ 101-37.302—101-37.303 [Reserved]

§ 101-37.304 Variable cost rate.

For the purpose of comparing costs (Government, commercial charter, and airline) associated with passenger transportation flights, as required by § 101-37.406, the agency should develop a variable cost rate for each aircraft or aircraft type as follows:

(a) Accumulate or allocate to the aircraft or aircraft type all historical costs, for the previous 12 months, grouped under the variable cost category defined in § 101-37.201. These costs should be obtained from the agency's accounting system.

(b) Adjust the historical variable costs for inflation and for any known upcoming cost changes to determine the projected variable cost. The inflation factor used should conform to the provisions of OMB Circular A-76.

(c) Divide the projected variable cost of the aircraft or aircraft type by the projected annual flying hours for the aircraft or aircraft type to compute the variable cost rate (per flying hour).

(d) To compute the variable cost for a proposed trip, multiply the variable cost rate by the estimated number of flying hours for the trip. The number of flying hours should include:

(1) If no follow-up trip is scheduled, all time required to position the aircraft to begin the trip and to return the aircraft to its normal base of operations.

(2) If a follow-on trip requires repositioning, the cost for repositioning should be charged to the associated follow-on trip.

(3) If an aircraft supports a multi-leg trip (a series of flights scheduled sequentially), the use of the aircraft for the total trip may be justified by comparing the total variable cost of the entire trip to the commercial aircraft cost (including charter) for all legs of the trip.

§ 101-37.305 Acquisition and management.

(a) The number and size of aircraft acquired by an agency and the capacity of those aircraft to carry passengers and cargo shall not exceed the level

§ 101-37.400

41 CFR Ch. 101 (7-1-01 Edition)

necessary to meet the agency's mission requirements.

(b) Agencies must comply with OMB Circular A-76 before purchasing, leasing, or otherwise acquiring aircraft and related services to assure that these services cannot be obtained from and operated by the private sector more cost effectively.

(c) Agencies shall review on a 5-year cycle the continuing need for all of their aircraft and the cost effectiveness of their aircraft operations in accordance with OMB approved cost justification methodologies. A copy of each agency review shall be submitted to GSA when completed and to OMB with the agency's next budget submission. Agencies shall report any excess aircraft and release all aircraft that are not fully justified by these reviews.

(d) Agencies shall use their aircraft in the most cost effective way to meet their requirements.

Subpart 101-37.4—Use of Government-Owned and -Operated Aircraft

SOURCE: 58 FR 53660, Oct. 18, 1993, unless otherwise noted.

§ 101-37.400 General.

The provisions of this subpart prescribe policies and procedures for the use of Government aircraft. This subpart incorporates certain provisions of OMB Circular A-126 and OMB Bulletin Number 93-11.

§ 101-37.401 [Reserved]

§ 101-37.402 Policy.

Government aircraft shall be used for official purposes only in accordance with applicable laws and regulations, including this subpart.

(a) Use of Government aircraft. Agencies shall operate Government aircraft only for official purposes. Official purposes include the operation of Government aircraft for:

- (1) Mission requirements, and
- (2) Other official travel.

(b) Use of Government aircraft for official travel or on space available travel is subject to paragraphs (b)(1) and (2) of this section.

(1) Use of a Government aircraft for official travel other than required use travel or mission requirement travel; i.e., for the conduct of agency business, shall be authorized only when:

(i) No commercial airline or aircraft service (including charter) is reasonably available to fulfill effectively the agency's requirement; or

(ii) The actual cost of using a Government aircraft is not more than the cost of commercial airline or aircraft service (including charter). When a flight is made for mission requirements or required use travel (and is certified as such in writing by the agency which is conducting the mission), it is presumed that secondary use of the aircraft for other travel for the conduct of agency business will result in cost savings.

(2) Use of a Government aircraft on a space available basis is authorized only when:

(i) The aircraft is already scheduled for use for an official purpose;

(ii) Space available travel does not require a larger aircraft than needed for the already scheduled official purpose;

(iii) Space available use results in no, or only minor, additional cost to the Government; and

(iv) Reimbursement is provided as set forth in § 101-37.403 of this subpart.

(c) The Secretary of State, Secretary of Defense, Attorney General, Director of the Federal Bureau of Investigation, and the Director of Central Intelligence may use Government aircraft for travel other than:

(1) To meet mission requirements, or

(2) For the conduct of agency business, but only upon reimbursement at full coach fare and with authorization by the President or his designated representative on the grounds that a threat exists which could endanger lives or when continuous 24-hour secure communication is required.

§ 101-37.403 Reimbursement for the use of Government aircraft.

A passenger transported by Government aircraft is required to reimburse the Government under the circumstances specified, and in the amount indicated, in paragraphs (a) through (d) of this section.

Federal Property Management Regulations

§ 101-37.405

(a) For travel that is not required use travel:

(1) Any incidental private activities (personal or political) of an employee undertaken on an employee's own time while on official travel shall not result in any increase in the actual costs to the Government of operating the aircraft, and

(2) The Government shall be reimbursed the appropriate share of the full coach fare for any portion of the time on the trip spent on political activities (except as otherwise provided in paragraph (d) of this section).

(b) For required use travel (except as otherwise provided in paragraph (d) of this section).

(1) For a wholly personal or political trip, the Government shall be reimbursed the full coach fare for the trip.

(2) For an official trip during which the employee engages in political activities, the Government shall be reimbursed the appropriate share of the full coach fare for the entire trip, and

(3) For an official trip during which the employee flies to one or more locations for personal reasons, the Government shall be reimbursed the excess of the full coach fare of all flights taken by the employee on the trip over the full coach fare of the flights that would have been taken by the employee had there been no personal activities on the trip.

(c) For space available travel, whether on mission requirements or other flights, the Government shall be reimbursed at the full coach fare except:

(1) As authorized under 10 U.S.C. 4744 and regulations implementing that statute, and

(2) By civilian personnel and their dependents in remote locations not reasonably accessible to regularly scheduled commercial airline service.

(d) In any case of political travel, reimbursement shall be made in the amount required by law or regulation (e.g., 11 CFR 106.3) if greater than the amount otherwise required under paragraphs (a) through (c) of this section.

§ 101-37.404 Approving the use of Government aircraft for transportation of passengers.

(a) Use of Government aircraft for official travel may be approved only by

the agency head or official(s) designated by the agency head.

(b) Whenever a Government aircraft used to fulfill a mission requirement is used also to transport senior Federal officials, members of their families or other non-Federal travelers on a space available basis (except as authorized under 10 U.S.C. 4744 and regulations implementing that statute), the agency that is conducting the mission shall certify in writing prior to the flight that the aircraft is scheduled to perform a bona fide mission activity, and that the minimum mission requirements have not been exceeded in order to transport such space available travelers. In emergency situations, an after-the-fact written certification by the agency is permitted.

[60 FR 3552, Jan. 18, 1995]

§ 101-37.405 Approving travel on Government aircraft.

Policy and practices under which travel on Government aircraft may be approved by the agency are specified in paragraphs (a) through (c) of this section.

(a) All travel on Government aircraft must have advance authorization by the sponsoring agency in accordance with its travel policies, OMB Circular A-126 and, when applicable, documented on an official travel authorization. Where possible, such travel authorization must be approved by at least one organizational level above that of the person(s) traveling. If review by a higher organizational level is not possible, another appropriate approval is required.

(b) All required use travel must have written approval on a trip-by-trip basis from the agency's senior legal official or the principal deputy, unless:

(1) The President has determined that all travel or travel in specified categories by an agency head is qualified as required use travel, or

(2) The agency head has determined that all travel or travel in specified categories by an officer or employee other than the agency head, is qualified as required use travel.

(i) Any determination by an agency head that travel by an officer or employee of that agency qualifies as required use travel must be in writing

§ 101-37.406

41 CFR Ch. 101 (7-1-01 Edition)

and set forth the basis for that determination. In emergency situations an after-the-fact written certification by an agency is permitted.

(ii) An agency head opting to determine that travel by an officer or employee may be required use travel shall establish written standards for determining when required use travel is permitted. Such travel shall not be permitted unless the travel is in conformance with the written standards.

(c) All travel by senior Federal officials, family members of senior Federal officials, and non-Federal travelers that is not to meet mission requirements or required use travel must be authorized in advance and in writing.

(1) Such authorization must be approved on a trip-by-trip basis and must be signed by the agency's senior legal official or the principal deputy, or be in conformance with an agency review and approval system that has been approved by the Office of Management and Budget (OMB). In emergency situations, an after-the-fact written certification by an agency is permitted.

(2) In addition to the provisions of this subpart, Federal employees on official travel shall be subject to all other applicable travel rules and regulations. Travel by such individuals that is not official travel, for purposes of this subpart, is subject to the reimbursement requirements in §101-37.403(c) of this subpart for space available travel.

§ 101-37.406 Justification of the use of Government aircraft for transportation of passengers.

(a) The cost comparison justifying the use of a Government aircraft for a proposed trip as required by §101-37.402(b)(1)(ii) of this subpart should be made prior to authorizing the use of the aircraft for that trip. Standard trip cost justification schedules developed by agencies may be used for this purpose. Agencies that are not able to use such schedules are required to conduct a cost justification on a case-by-case basis.

(b) When conducting a cost comparison, the agency must compare the actual cost of using a Government aircraft to the cost of using a commercial aircraft (including charter) or airline

service. The actual cost of using a Government aircraft is either:

(1) The amount that the agency will be charged by the organization that provides the aircraft,

(2) The variable cost of using the aircraft, if the agency operates its own aircraft, or

(3) The variable cost of using the aircraft as reported by the owning agency, if the agency is not charged for the use of an aircraft owned by another agency.

(c) The cost of using commercial airline or aircraft services for the purpose of justifying the use of Government aircraft:

(1) Must be the current Government contract fare or price, or the lowest fare or price available for the trip(s) in question,

(2) Must include, as appropriate, any differences in the cost of ground travel, per diem and miscellaneous travel (e.g., taxis, parking, etc.), and lost employees' work time (computed at gross hourly costs to the Government, including benefits), between using Government aircraft and commercial aircraft services, and

(3) Must include only the costs associated with passengers on official business. Costs associated with passengers traveling on a space available basis may not be used in the cost comparison.

§ 101-37.407 Documentation.

All uses of Government aircraft must be documented, and this documentation must be retained for at least 2 years by the aircraft operations manager. The documentation of each use of Government aircraft must include the information specified in paragraphs (a) through (g) of this section:

(a) Aircraft registration number (the registration number assigned by the Federal Aviation Administration or military-designated tail number);

(b) Purpose of the flight (the mission the aircraft was dispatched to perform);

(c) Route(s) flown;

(d) Flight date(s) and times;

(e) Name of each traveler;

(f) Name(s) of the pilot(s) and aircrew;

Federal Property Management Regulations

§ 101-37.502

(g) When Government aircraft are used to support official travel, the documentation must also include evidence that §101-37.408 and other applicable provisions of this FPMR have been satisfied.

§ 101-37.408 Reporting travel by senior Federal officials.

Agencies shall submit semi-annual reports for the periods October 1 through March 31 (due May 31), and April 1 through September 30 (due November 30) to the General Services Administration, Aircraft Management Division, Washington, DC 20406. A copy of each report shall also be submitted to the Deputy Director for Management, Office of Management and Budget, 725 17th Street, NW, Washington, DC 20503. Agencies shall submit report data using the Federal Aviation Management Information System structure and management codes for automated reporting or GSA Form 3641, Senior Federal Travel. Agencies that did not transport any senior Federal officials or special category travelers during the relevant time frame must still submit a written response that acknowledges the reporting requirements and states they have no travel to report. These reports shall be disclosed to the public upon request unless classified.

(a) Reports shall include data on all non-mission travel by senior Federal officials on Government aircraft (including those senior Federal officials acting in an aircrew capacity when they are also aboard the flight for transportation), members of the families of such officials, any non-Federal traveler (except as authorized under 10 U.S.C. 4744 and regulations implementing that statute), and all mission and non-mission travel for senior executive branch officials. The reports shall include:

- (1) The names of the travelers;
- (2) The destinations;
- (3) The corresponding commercial cost had the traveler used commercial airline or aircraft service (including charter);
- (4) The appropriate allocated share of the full operating cost of each trip;
- (5) The amount required to be reimbursed to the Government for the flight;

(6) The accounting data associated with the reimbursement; and

(7) The data required by §101-37.407 (a), (b), and (d) of this subpart.

(b) Each agency is responsible for reporting travel by personnel transported on aircraft scheduled by that agency.

(c) The agency using the aircraft must also maintain the data required by this section for classified trips. This information shall not be reported to GAS or OMB but must be made available by the agency for review by properly cleared personnel.

[60 FR 3553, Jan. 18, 1995]

Subpart 101-37.5—Management Information Systems (MIS)

SOURCE: 60 FR 3553, Jan. 18, 1995, unless otherwise noted.

§ 101-37.500 General.

Executive agencies must maintain an aviation MIS. Agency systems will include computer applications appropriate to the complexity of the operation. Systems should be integrated among bureaus, agencies, and Departments as appropriate to maximize efficiency and effectiveness Governmentwide. MIS capabilities will include, but are not limited to, collecting, consolidating, and producing the reports and analyses required by: field-level organizations for day-to-day operations, agencies to justify the continuing use of aircraft or new acquisitions, GSA to develop Governmentwide aviation management guidance, and OMB and other oversight agencies to capitalize on opportunities to improve efficiency and effectiveness.

§ 101-37.501 [Reserved]

§ 101-37.502 GSA MIS responsibilities.

The Aircraft Management Division will operate the Governmentwide aircraft MIS (also known as the Federal Aviation Management Information System (FAMIS)), develop generic aircraft MIS standards and software, and provide technical assistance to agencies in establishing automated aircraft information and cost accounting systems and conducting cost analyses required by OMB. The FAMIS will collect

§ 101-37.503

and maintain summary data including, but not limited to:

- (a) Aircraft and aviation related facilities inventories;
- (b) Cost and utilization for owned aircraft and aviation facilities;
- (c) Cost and utilization for chartered, rented, or contracted aircraft;
- (d) Inventories of support service agreements; and
- (e) Senior Federal official and special category travel data.

§ 101-37.503 Reporting responsibilities.

Reporting responsibilities are as follows:

- (a) *Owned aircraft.* The executive agency to which the aircraft is registered in conformance with the FAA regulations or appropriate military regulations is responsible for reporting inventory, cost, and utilization data for each aircraft.
- (b) *Bailed aircraft.* The executive agency which operates bailed aircraft is responsible for reporting inventory, cost, and utilization data for each aircraft.
- (c) *Leased or lease/purchased aircraft.* The executive agency which makes payment to a private or other public sector organization for the aircraft is responsible for reporting inventory, cost, and utilization data for each aircraft.
- (d) *Loaned aircraft.* The executive agency which owns an aircraft on loan to a Federal agency will report inventory, cost, and utilization data. The executive agency which owns an aircraft on loan to a State, cooperator, or other non-Federal entity will report inventory data associated with that aircraft.
- (e) *Contract, charter, and rental aircraft.* The executive agency which makes payment to a private sector or other public sector organization for the aircraft is responsible for reporting cost and utilization data by specific aircraft for each type of mission performed.
- (f) *Support services.* The executive agency establishing the aviation support services agreement with service vendors is responsible for reporting associated data by agreement number, aircraft or service type, and vendor.
- (g) *Senior Federal official and special category travel.* Each executive agency

41 CFR Ch. 101 (7-1-01 Edition)

is responsible for reporting travel by personnel transported on aircraft scheduled by that agency.

§ 101-37.504 Reports.

Executive agencies will submit aviation management data using FAMIS structure format for automated reporting or appropriate forms. FAMIS data shall be submitted to the General Services Administration, Aircraft Management Division, Washington, DC 20406. Interagency report control number 0322-GSA-AN has been assigned to these reports. To the extent that information is protected from disclosure by statute, an agency is not required to furnish information otherwise required to be reported under this subpart.

(a) Each executive agency will provide GSA with reports as changes occur for:

(1) *Facilities inventories.* Additions, deletions, and changes shall be submitted using GSA Form 3549, Government-owned/leased Maintenance, Storage, Training, Refueling Facilities (per facility) or FAMIS file structures.

(2) *Aircraft inventories.* Additions, deletions, and changes shall be submitted using GSA Form 3550, Government Aircraft Inventory (per aircraft) or FAMIS file structures. Any aircraft operated or held in a non-operational status, must be reported to FAMIS regardless of its ownership category.

(3) *Aviation support services cost data.* This data will be submitted using GSA Form 3554, Aircraft Contract/Rental/Charter Support Services Cost Data Form or FAMIS file structures, as support service agreements become effective.

(b) Each executive agency will provide GSA with reports annually on or before January 15 for the previous fiscal year ending September 30 for:

(1) *Contract, rental, and charter aircraft cost and utilization data.* Each form or FAMIS database record must contain only one aircraft for each type of mission performed. The data is submitted using GSA Form 3551, Contract/Charter/Rental Aircraft Cost and Utilization or FAMIS file structures.

(2) *Government aircraft cost and utilization data.* The cost and utilization information must be tracked by serial number and must reflect the actual use

Federal Property Management Regulations

§ 101-37.601

and expenditures incurred for each individual aircraft. These reports are to be submitted using GSA Form 3552, Government Aircraft Cost and Utilization or FAMIS file structures.

(c) Each executive agency will provide GSA with a report semiannually on or before May 31 for the period October 1 through March 30, and on or before November 30 for the period April 1 through September 30 for senior Federal official and special category travel. These reports are to be submitted using GSA Form 3641, Senior Federal Travel or FAMIS file structures. Executive agencies that did not transport any senior Federal officials or special category travelers during the relevant time frame must submit a written response that acknowledges the reporting requirements and states that they have no travel to report. For detailed explanation see §101-37.408.

§ 101-37.505 Aircraft used for sensitive missions.

Inventory, cost, and utilization data submitted to GSA for agency aircraft dedicated to national defense, law enforcement, or interdiction missions will be safeguarded as specified in §101-37.506. GSA will not allow identification (registration number, serial number, etc.), location, or use patterns to be disclosed except as required under the Freedom of Information Act.

§ 101-37.506 Reporting requirements for law enforcement, national defense, or interdiction mission aircraft.

Agencies using aircraft for law enforcement, national defense, or interdiction missions may use reporting provisions which provide for agency information protection as specified in paragraphs (a) and (b) of this section.

(a) *Undercover aircraft.* Agencies operating undercover aircraft as defined in §101-37.100, will report to GSA all FAMIS data in accordance with §101-37.504, to include the registration number and serial number as reported to the Federal Aviation Administration (FAA), Office of Aircraft Registry.

(b) *Deep cover aircraft.* Agencies operating deep cover aircraft as defined in §101-37.100, will report to GSA all FAMIS data in accordance with §101-

37.504, except for that data requiring special handling by the FAA. Specific identifying data for those aircraft requiring special handling by the FAA will be reported as follows:

(1) *Special number data.* Initially, agencies will supply the actual aircraft serial number with a unique code number. The code number will be used for all future data submissions. GSA will maintain the actual serial number and associated code in a secured file independent from all other FAMIS data. The secured file containing aircraft serial number data will not be printed or distributed.

(2) *Registration number data.* Agencies will not submit registration number (FAA registration number) for deep cover aircraft.

(3) *Location data.* Agencies will not submit location data.

Subpart 101-37.6—Management, Use, and Disposal of Government Aircraft Parts

SOURCE: 62 FR 43472, Aug. 14, 1997, unless otherwise noted.

§ 101-37.600 What does this subpart do?

This subpart prescribes special policies and procedures governing the management, use, and disposal of Government-owned aircraft parts.

§ 101-37.601 What responsibilities does the owning/operating agency have in the management and use of Government aircraft parts?

(a) The owning/operating agency is responsible for ensuring the continued airworthiness of an aircraft, including replacement parts. The owning/operating agency must ensure that replacement parts conform to an approved type design, have been maintained in accordance with applicable standards, and are in condition for safe operation.

(b) In evaluating the acceptability of a part, the owning/operating agency should review the appropriate log books and historical/maintenance records. The maintenance records must contain the data set forth in the latest version of Federal Aviation Administration (FAA) Advisory Circular 43-9. When the quality and origin of a part is

§ 101-37.602

questionable, the owning/operating agency should seek guidance from the local FAA Flight Standards District Office (FSDO) in establishing the part's airworthiness eligibility.

§ 101-37.602 Are there special requirements in the management, use, and disposal of military Flight Safety Critical Aircraft Parts (FSCAP)?

(a) Yes. Any aircraft part designated by the Department of Defense as a FSCAP must be identified with the appropriate FSCAP Criticality Code which must be perpetuated on all documentation pertaining to such parts.

(b) A military FSCAP may be installed on a FAA type-certificated aircraft holding either a restricted or standard airworthiness certificate, provided the part is inspected and approved for such installation in accordance with the applicable Federal Aviation Regulations.

(c) If a FSCAP has no maintenance or historical records with which to determine its airworthiness, it must be mutilated and scrapped in accordance with § 101-37.609. However, FSCAP still in its original unopened package, and with sufficient documentation traceable to the Production Approval Holder (PAH), need not be mutilated. Undocumented FSCAP with no traceability to either the original manufacturer or PAH must not be made available for transfer or donation. For assistance in the evaluation of FSCAP, contact the local FAA Flight Standards District Office (FSDO).

§ 101-37.603 What are the owning/operating agency's responsibilities in reporting excess Government aircraft parts?

(a) The owning/operating agency must report excess aircraft parts to GSA in accordance with the provisions set forth in part 101-43 of this chapter. The owning/operating agency must indicate on the reporting document if any of the parts are life-limited parts and/or military FSCAP, and ensure that tags and labels, applicable historical data and maintenance records accompany these aircraft parts.

(b) The owning/operating agency must identify excess aircraft parts which are unsalvageable according to FAA or DOD guidance, and ensure that

41 CFR Ch. 101 (7-1-01 Edition)

such parts are mutilated in accordance with § 101-37.609. The owning/operating agency should not report such parts to GSA.

§ 101-37.604 What are the procedures for transferring and donating excess and surplus Government aircraft parts?

(a) Transfer and donate excess and surplus aircraft parts in accordance with part 101-43, Utilization of Personal Property, and part 101-44, Donation of Personal Property.

(b) Unsalvageable aircraft parts must not be issued for transfer or donation; they must be mutilated in accordance with § 101-37.609.

§ 101-37.605 What are the receiving agency's responsibilities in the transfer or donation of excess and surplus Government aircraft parts?

(a) The receiving agency must verify that all applicable labels and tags, and historical/modification records are furnished with the aircraft parts. The receiving agency must also ensure the continued airworthiness of these parts by following proper storage, protection and maintenance procedures, and by maintaining appropriate records throughout the life cycle of these parts.

(b) The receiving agency must perpetuate the DOD-assigned Criticality Code on all property records of acquired military FSCAP. The receiving agency must ensure that flight use of military FSCAP on civil aircraft meets all Federal Aviation Regulation requirements.

(c) The receiving agency must certify and ensure that when a transferred or donated part is no longer needed, and the part is determined to be unsalvageable, the part must be mutilated in accordance with § 101-37.609 and properly disposed.

§ 101-37.606 What are the GSA approving official's responsibilities in transferring and donating excess and surplus Government aircraft parts?

(a) The GSA approving official must review transfer documents of excess and surplus aircraft parts for completeness and accuracy, and ensure that the

Federal Property Management Regulations

§ 101-37.610

certification required in §101-37.605(c) is included in the transfer document.

(b) The GSA approving official must also ensure the following statement is included on the SF123, Transfer Order Surplus Personal Property:

“Due to the critical nature of aircraft parts failure and the resulting potential safety threat, recipients of aircraft parts must ensure that any parts installed on a civil aircraft meet applicable Federal Aviation Administration Regulations, and that required certifications are obtained. The General Services Administration makes no representation as to a part’s conformance with FAA requirements.”

§ 101-37.607 What are the State Agency’s responsibilities in the donation of surplus Government aircraft parts?

(a) The State Agency must review donation transfer documents for completeness and accuracy, and ensure that the certification provisions set forth in §101-37.605(c) is included in the transfer documents.

(b) The State Agency must ensure that when a donated part is no longer needed, and the part is determined to be unsalvageable, the donee mutilates the part in accordance with §101-37.609.

§ 101-37.608 What are the responsibilities of the Federal agency conducting the sale of Government aircraft parts?

(a) The Federal agency must sell Government aircraft parts in accordance with the provisions set forth in Part 101-45, Sale, Abandonment, or Destruction of Personal Property of this chapter.

(b) The Federal agency must ensure that the documentation required pursuant to §101-37.603(a) accompanies the parts at the time of sale, and that sales offerings on aircraft parts contain the following statement:

“Purchasers are warned that the parts purchased herewith may not be in compliance with applicable Federal Aviation Administration requirements. Purchasers are not exempted from and must comply with applicable Federal Aviation Administration requirements. Purchasers are solely responsible for all FAA inspections and/or modifications necessary to bring the purchased items into compliance with 14 CFR (Code of Federal Regulations).”

(c) The Federal agency must ensure that the following certification is executed by the purchaser and received by the Government prior to releasing such parts to the purchaser:

“The purchaser agrees that the Government shall not be liable for personal injuries to, disabilities of, or death of the purchaser, the purchaser’s employees, or to any other persons arising from or incident to the purchase of this item, its use, or disposition. The purchaser shall hold the Government harmless from any or all debts, liabilities, judgments, costs, demands, suits, actions, or claims of any nature arising from or incident to purchase or resale of this item.”

§ 101-37.609 What are the procedures for mutilating unsalvageable aircraft parts?

(a) Identify unsalvageable aircraft parts which require mutilation.

(b) Mutilate unsalvageable aircraft parts so they can no longer be utilized for aviation purposes. Mutilation includes destruction of the data plate, removing the serial/lot/part number, and cutting, crushing, grinding, melting, burning, or other means which will prevent the parts from being misidentified or used as serviceable aircraft parts. Obtain additional guidance on the mutilation of unsalvageable aircraft parts in FAA AC No. 21-38, Disposition of Unsalvageable Aircraft Parts and Materials.

(c) Ensure an authorized agency official witnesses and documents the mutilation, retain a signed certification and statement of mutilation.

(d) If unable to perform the mutilation, turn in the parts to a Federal or Federally-approved facility for mutilation and proper disposition. Ensure that contractor performance is in accordance with the provisions of this part.

(e) Ensure that mutilated aircraft parts are sold only as scrap.

§ 101-37.610 Are there special procedures for the exchange/sale of Government aircraft parts?

Yes. Executive agencies may exchange or sell aircraft parts as part of a transaction to acquire similar replacement parts in accordance with FPMR part 101-46. In addition to the requirements of this subpart, agencies must ensure that the exchange/sale

§ 101-37.1100

41 CFR Ch. 101 (7-1-01 Edition)

transaction is accomplished in accordance with the methods and procedures contained in part 101-46 of this chapter, and comply with the restrictions and limitations under §101-46.202 of this chapter.

(a) Prior to the proposed exchange/sale, agencies should determine whether the parts identified for disposition are airworthy parts. For additional guidance refer to the applicable FAA Advisory Circular(s), or contact the local FAA FSDO.

(b) At the time of exchange or sale, agencies must ensure that applicable labels and tags, historical data and modification records accompany the aircraft parts prior to release. The records must contain the information and content as required by current DOD and FAA requirements for maintenance and inspections.

(c) Life limited parts that have reached or exceeded their life limits, or which have missing or incomplete documentation, must either be returned to the FAA production approval holder as part of an exchange transaction, or mutilated in accordance with §101-37.609.

(d) Unsalvageable aircraft parts, other than parts in paragraph (c) of this section, must not be used for exchange/sale purposes; they must be mutilated in accordance with §101-37.609.

Subparts 101-37.7—101-37.10 [Reserved]

Subpart 101-37.11—Aircraft Accident and Incident Reporting and Investigation

SOURCE: 63 FR 43638, Aug. 14, 1998, unless otherwise noted.

§ 101-37.1100 What are my general responsibilities for aircraft accident and incident reporting and investigation?

You must:

(a) Develop a Federal agency specific aircraft accident and incident response plan for your agency;

(b) Be prepared to participate in National Transportation Safety Board (NTSB) investigations of Federal agency aircraft accident or incidents involving your agency;

(c) Conduct a parallel investigation of an aviation accident/incident involving your agency aircraft as appropriate;

(d) Report any condition, act, maintenance problem, or circumstance which has potential to cause an aviation related mishap;

(e) Provide training to your agency personnel who may be asked to participate in an NTSB investigation;

(f) Assure that your reporting requirements are in compliance with the NTSB definitions contained in 49 CFR 830.2; and

(g) Refer to 49 CFR part 830 for further details when required to report an aircraft accident, incident, or overdue aircraft to the NTSB.

§ 101-37.1101 What aircraft accident and incident response planning must I do?

You must develop an agency specific aircraft accident and incident response plan which include the following:

(a) Reporting aircraft accidents, incidents, and overdue or missing aircraft,

(b) Wreckage site safety,

(c) Wreckage security,

(d) Evidence preservation, and

(e) A point of contact list with current telephone numbers for fire, crash rescue, medical, and law enforcement support personnel and trained agency accident investigators.

§ 101-37.1102 When must I give initial notification of an aircraft accident, incident, or overdue aircraft?

You must assure that the operator of any aircraft that is owned, leased, or under your exclusive use and operational control for more than 180 days immediately notifies the nearest NTSB field office when an accident or incident occurs.

§ 101-37.1103 What information must I give in an initial notification of an aircraft accident, incident, or overdue aircraft?

You must assure that the notification contains the following information, if available:

(a) Type and registration of the aircraft;

(b) Name of the owning agency;

(c) Name of the pilot-in-command;

(d) Date and time of the accident;

Federal Property Management Regulations

§ 101-37.1109

(e) Last point of departure and the point of intended landing;

(f) Position of the aircraft with reference to a geographical point;

(g) Number of persons aboard, number fatally injured, and number seriously injured;

(h) Nature of the accident, extent of damage, and the weather; and

(i) A description of any explosives, radioactive materials, or any other dangerous substances carried on the aircraft.

§ 101-37.1104 What are my responsibilities for preserving aircraft wreckage, cargo, mail, and records resulting from aircraft accidents and incidents?

You must assure that the operator of your aircraft is responsible for preserving to the extent possible any wreckage, cargo, and mail carried aboard the aircraft that was involved in an accident or incident. All records such as history data recordings of flight and maintenance information and voice recordings pertaining to the flight and all records pertaining to the operation and maintenance of the aircraft and to the airmen must be preserved until the NTSB takes custody. If items must be moved from the aircraft or the scene of the accident/incident for safety or health reasons, sketches, descriptive notes, or photographs should be made if possible of the original positions and conditions of items moved. If classified material is involved in an accident or incident, you must coordinate its protection and recovery with the National Transportation Safety Board as required by 49 CFR 830.10 and 831.12.

§ 101-37.1105 What must I report regarding an aircraft accident, incident, or overdue aircraft?

You must assure that the operator of your aircraft files a report on NTSB Form 6120.1 or 7120.2 within 10 days after an accident, or after 7 days if an overdue aircraft is still missing. A report involving a reportable incident shall be filed only if requested by the NTSB.

§ 101-37.1106 What must I do when the NTSB investigates an accident or incident involving my aircraft?

You should request designation as “party” to the investigation in accordance with 49 CFR 831.11 and assist the NTSB to the maximum extent possible. The NTSB shall allow you to participate in any investigation, except that you may not participate in the NTSB’s determination of the probable cause of the accident. You may conduct your own parallel investigation. You and the NTSB must exchange appropriate information obtained or developed in the course of the investigation(s) in a timely manner.

§ 101-37.1107 What must I do if I observe a condition, act, maintenance problem, or circumstance that has the potential to cause an aviation related mishap?

You must report such observations to a senior aviation safety manager of your agency.

§ 101-37.1108 Why is it important that I be provided aircraft accident/incident related guidance in the form of this subpart, in addition to that found in 49 CFR parts 830 and 831?

You may be excluded from some civil standards because of your unique operational and/or airworthiness requirements. Therefore, in addition to meeting the requirements found in 49 CFR parts 830 and 831, you must do the following: Make personnel who are knowledgeable about your missions and trained as aircraft accident investigators available to work with the NTSB. Develop accident and incident response plans. And understand that a parallel investigation may be conducted. Such teamwork will enhance both NTSB’s and your aircraft accident investigation and prevention efforts.

§ 101-37.1109 What training must I have to participate in an NTSB investigation?

You must be trained in aircraft accident investigation, reconstruction, and analysis. You must also receive aircraft accident investigation recurrency training and be familiar with NTSB accident investigation procedures.

Subpart 101-37.12—Federal Agency Aviation Safety Program

SOURCE: 59 FR 27486, May 27, 1994, unless otherwise noted.

§ 101-37.1200 General.

(a) This subpart sets forth guidance to agencies for establishing aviation safety programs in accordance with the direction given to GSA in OMB Circular A-126, but the subpart is not binding on other agencies.

(b) The aviation safety program objective is the safe accomplishment of the agency mission, and is a direct result of effective management which should include attention to detail sufficient to preclude the occurrence of an accident. Each agency should establish appropriate key management positions and define their responsibilities and qualifications. Agencies should ensure these positions are staffed with properly qualified personnel.

§ 101-37.1201 Applicability.

As prescribed in this subpart 101-37.12, the requirement to develop and operate an aviation safety program which addresses all program facets including, but not limited to, flight, ground, and weapons environments, is applicable to all Federal aviation programs.

§ 101-37.1202 Agency aviation safety responsibilities.

Agencies operating aviation programs are responsibilities for establishing and conducting a comprehensive aviation safety program. Agencies should appoint qualified aviation safety managers at both the national and operational program level.

§ 101-37.1203 Aviation safety manager qualifications.

(a) Aviation safety manager positions may be full time or additional duty, based on program mission requirements. In general, an aviation safety manager should, regardless of management level:

(1) Be knowledgeable in agency aviation program activities within his/her purview;

(2) Have experience as a pilot, crew member, or in aviation operations management; and

(3) Be a graduate of a recognized aviation safety officer or accident prevention course, or qualified within 1 year through attendance at formal courses(s) of instruction.

(b) These standards should be used as a guide to ensure that qualified personnel are selected as safety managers. However, they do not supersede those job classifications prescribed by the Office of Personnel Management or other appropriate authority.

§ 101-37.1204 Program responsibilities.

Agencies will ensure that policies, objectives, and standards are established and clearly defined to support an effective aviation accident prevention effort. The aviation safety manager should develop and implement an agency aviation safety program which integrates agency safety policy into aviation related activities.

§ 101-37.1205 Program elements.

As a recommendation, aviation safety program elements should include, but not be limited to, the following:

- (a) Aviation safety council;
- (b) Inspections and evaluations;
- (c) Hazard reporting;
- (d) Aircraft accident and incident investigation;
- (e) Education and training;
- (f) Aviation protective equipment;
- (g) Aviation qualification and certification; and
- (h) Awards program.

§ 101-37.1206 Aviation safety council.

(a) Each agency should establish aviation safety councils at the appropriate aircraft operations level. The purpose of the council is to promote safety by exchanging ideas, reviewing, and discussing hazard reports and accident and incident reports, and assessing the threat to safe operation inherent in mission operations plans. The council should function to recommend changes to agency policies, rules, regulations, procedures, and operations based upon such discussions, reviews, and assessments. The council should meet regularly and should consist, at a minimum, of those individuals within

Federal Property Management Regulations

§ 101-37.1213

the organization responsible for the following areas:

- (1) Operations/mission planning;
- (2) Safety;
- (3) Aircrew training;
- (4) Maintenance; and
- (5) Aircrew scheduling.

(b) Safety meetings for operations and maintenance personnel are used to increase the education and awareness of agency personnel regarding the hazards associated with aviation and to discuss mishap prevention. Meetings should be scheduled and conducted on a regular basis.

§ 101-37.1207 Inspections and evaluations.

The purpose of any inspection or evaluation is to prevent aviation accidents and to foster aviation safety.

(a) Each agency should establish and maintain an inspection and evaluation program for all aviation activities. All operational elements of the aviation activity should be regularly inspected and evaluated based on standardized criteria established by the agency. The purpose of this program is to ensure that the agency mission is being carried out in accordance with Federal and agency safety regulations and directives.

(b) Records should be kept and will identify the function or work area involved, date(s), hazard(s) identified, and recommended corrective action(s). All agencies will ensure appropriate resolution and close-out.

§ 101-37.1208 Hazard reporting.

Each agency safety program should include an aviation hazard reporting and resolution tracking system. Hazards are identified as conditions, practices, or procedures that constitute an immediate or potential threat to the safe conduct of aviation operations and may be reported by any person. Reports may be submitted on any event, procedure, practice, or condition that adversely affects safety of aviation operations. Prompt resolution of hazards, by safety threat priority, should be the goal of the agency.

§ 101-37.1209 Aircraft accident and incident investigation and reporting.

Each agency aviation safety program should have an aircraft accident and incident investigation and reporting capability (see subpart 101-37.11).

§ 101-37.1210 Education and training.

Each aviation operations program should develop and conduct aviation safety training within applicable OPM guidelines. Identification, development, and presentation of training needs that are unique to respective programs should be accomplished as required. Training frequency, duration, and currency requirements should be developed for each safety discipline, and should consist of initial and recurring training.

§ 101-37.1211 Aviation protective equipment.

Each agency should establish an aviation protective equipment program. Such a program should ensure that all personnel flying aboard agency aircraft are equipped with, or have at their disposal, appropriate aviation life support equipment.

§ 101-37.1212 Aircrew qualification and certification.

Minimum standards for aircraft operations are established by OPM Position Classification Series GS-2181. Agencies should periodically review operational requirements to establish or revise aircrew standards. Such standards should ensure that aircrew members meet the minimum qualification and certification necessary for the continued safe operation of aircraft.

§ 101-37.1213 Aircraft accident and incident database.

Each agency should establish an aircraft accident and incident data collection system to support an effective aviation safety and accident prevention program. The database should include:

- (a) Owner and operator of the aircraft;
- (b) Federal Aviation Administration registration number or assigned tail number;
- (c) Aircraft make, model, and serial number;

§ 101-37.1214

- (d) Location of occurrence;
- (e) Date of mishap (month/day/year);
- (f) Type of mishap, accident, or incident (see § 101-37.1101, Definitions);
- (g) Estimated damage to the aircraft;
- (h) Type of injury; no injury, serious injury, or fatal injury (see § 101-37.1101, Definitions);
- (i) Brief description of the circumstances; and
- (j) Name of the investigator as it appears on the factual report (see § 101-37.1108).

§ 101-37.1214 Aviation safety awards program.

Each agency should establish an aviation safety awards program to recognize individuals and organizations for exceptional acts or service in support of the organizational aviation safety program. Such a program should provide for awards in flight, ground, and weapons safety, if applicable.

Subpart 101-37.13 [Reserved]

Subpart 101-37.14—Forms

§ 101-37.1400 General.

This subpart provides the necessary information to obtain forms prescribed or available for use in connection with the subject matter covered in part 101-37. These forms are designed to provide a uniform method of requesting and transmitting aviation management information and uniform documentation of transactions among Government agencies.

§ 101-37.1401 GSA forms availability.

Copies of the forms identified in paragraphs (a) through (e) of this section may be obtained from the General Services Administration (FBX), Washington, DC 20406.

(a) GSA Form 3549, Government-owned/Leased Maintenance, Storage, Training, Refueling Facilities (Per Facility).

(b) GSA Form 3550, Government Aircraft Inventory (Per Aircraft).

(c) GSA Form 3551, Contract/Rental/Charter Aircraft Cost and Utilization.

(d) GSA Form 3552, Government Aircraft Cost and Utilization (Per Aircraft).

41 CFR Ch. 101 (7-1-01 Edition)

(e) GSA Form 3554, Aircraft Contract, Rental/Charter and Support Services Cost Data Form.

PART 101-38—MOTOR VEHICLE MANAGEMENT

AUTHORITY: Sec. 205(c), 63 Stat. 390 (40 U.S.C. 486(c)).

SOURCE: 64 FR 59593, Nov. 2, 1999, unless otherwise noted.

§ 101-38.000 Cross-reference to the Federal Management Regulation (FMR) (41 CFR chapter 102, parts 102-1 through 102-220).

For motor vehicle management policy, see FMR part 34 (41 CFR part 102-34).

PART 101-39—INTERAGENCY FLEET MANAGEMENT SYSTEMS

Sec.

101-39.000 Scope of part.

Subpart 101-39.0—General Provisions

101-39.001 Authority.

101-39.002 Applicability.

101-39.003 Financing.

101-39.004 Optional operations.

Subpart 101-39.1—Establishment, Modification, and Discontinuance of Interagency Fleet Management Systems

101-39.100 General.

101-39.101 Notice of intention to begin a study.

101-39.101-1 Agency cooperation.

101-39.102 Determinations.

101-39.102-1 Records, facilities, personnel, and appropriations.

101-39.102-2 Effective date of determination.

101-39.103 Agency appeals.

101-39.104 Notice of establishment of a fleet management system.

101-39.104-1 Consolidations into a fleet management system.

101-39.104-2 Reimbursement.

101-39.105 Discontinuance or curtailment of service.

101-39.105-1 Transfers from discontinued or curtailed fleet management systems.

101-39.105-2 Agency requests to withdraw participation.

101-39.106 Unlimited exemptions.

101-39.107 Limited exemptions.

Federal Property Management Regulations

§ 101-39.003

Subpart 101-39.2—GSA Interagency Fleet Management System Services

- 101-39.200 Scope.
- 101-39.201 Services available.
- 101-39.202 Contractor authorized services.
- 101-39.203 Obtaining motor vehicles for short-term use.
- 101-39.203-1 Obtaining motor vehicles while on temporary duty (TDY) travel.
- 101-39.204 Obtaining motor vehicles for indefinite assignment.
- 101-39.205 [Reserved]
- 101-39.206 Seasonal or unusual requirements.
- 101-39.207 Reimbursement for services.
- 101-39.208 Vehicles removed from defined areas.

Subpart 101-39.3—Use and Care of GSA Interagency Fleet Management System Vehicles

- 101-39.300 General.
- 101-39.301 Utilization guidelines.
- 101-39.302 Rotation.
- 101-39.303 Maintenance.
- 101-39.304 Modification or installation of accessory equipment.
- 101-39.305 Storage.
- 101-39.306 Operator's packet.
- 101-39.307 Grounds for withdrawal of vehicle.

Subpart 101-39.4—Accidents and Claims

- 101-39.400 General.
- 101-39.401 Reporting of accidents.
- 101-39.402 Recommendations for disciplinary action.
- 101-39.403 Investigations.
- 101-39.404 Claims in favor of the Government.
- 101-39.405 Claims against the Government.
- 101-39.406 Responsibility for damages.
- 101-39.407 Accident records.

Subparts 101-39.5—101-39.48 [Reserved]

Subpart 101-39.49—Forms

- 101-39.4900 Scope of subpart.
- 101-39.4901 Obtaining standard and optional forms.

AUTHORITY: Sec. 205(c), 63 Stat. 390 (40 U.S.C. 486(c)).

SOURCE: 51 FR 11023, Apr. 1, 1986, unless otherwise noted.

§ 101-39.000 Scope of part.

This part prescribes policies governing the establishment and operation of interagency fleet management systems and operating procedures applicable to the General Services Adminis-

tration (GSA) Interagency Fleet Management System.

[56 FR 59887, Nov. 26, 1991]

Subpart 101-39.0—General Provisions

§ 101-39.001 Authority.

Section 211 of the Federal Property and Administrative Services Act of 1949, as amended, (40 U.S.C. 491), requires that the Administrator of General Services will, to the extent that he determines that so doing is advantageous to the Government in terms of economy, efficiency, or service, and after consultation with, and with due regard to the program activities of the agencies concerned, (a) consolidate, take over, acquire, or arrange for the operation by any executive agency of motor vehicles and other related equipment and supplies for the purpose of establishing fleet management systems to serve the needs of executive agencies; and (b) provide for the establishment, maintenance, and operation (including servicing and storage) of fleet management systems for transportation of property or passengers, and for furnishing such motor vehicles and related services to executive agencies. The exercise of this authority is subject to regulations issued by the President, which are set forth in Executive Order 10579, dated November 30, 1954.

§ 101-39.002 Applicability.

The regulations in this part apply to all executive agencies of the Federal Government to the extent provided in the Act.

§ 101-39.003 Financing.

(a) Section 211(d) of the Federal Property and Administrative Services Act, 1949, as amended, provides that the General Supply Fund, provided for in section 109 of the Act, shall be available for use by or under the direction and control of the Administrator of General Services for paying all elements of cost incident to the establishment, maintenance, and operation of fleet management systems.

§ 101-39.004

(b) When an agency other than GSA operates an interagency fleet management system, the financing and accounting methods shall be developed by GSA in cooperation with the agency concerned.

[51 FR 11023, Apr. 1, 1986, as amended at 56 FR 59887, Nov. 26, 1991]

§ 101-39.004 Optional operations.

Nothing in this part shall preclude the establishment or operation of interagency fleet management systems by GSA or by other agencies which are to be operated on the basis of optional use by executive or other agencies under arrangements worked out between the agencies concerned and GSA.

[56 FR 59887, Nov. 26, 1991]

Subpart 101-39.1—Establishment, Modification, and Discontinuance of Interagency Fleet Management Systems

§ 101-39.100 General.

GSA will conduct studies of the operation and costs of motor vehicle and motor vehicle services in selected geographical areas to determine the advisability of establishing fleet management systems.

(a) Based on these studies, the Administrator of General Services, with the assistance of the affected agencies, shall develop necessary data and cost statistics for use in determining the feasibility of establishing a fleet management system in the geographical area studied.

(b) If the Administrator, GSA, determines that a fleet management system shall be established, a formal determination is prepared to that effect.

(c) In the event the Administrator, GSA, decides that the establishment of a fleet management system is not feasible, the head of each agency concerned will be notified.

(d) In the making of determinations for the establishment of fleet management systems, the Administrator, GSA, will, to the extent consistent with the provisions of section 1(b) of Executive Order 10579, observe the policies outlined in the Office of Management and Budget (OMB) Circular A-76,

41 CFR Ch. 101 (7-1-01 Edition)

for the utilization of commercial facilities.

(e) Except as provided in this subpart, all Government motor vehicles subsequently acquired for official purposes by fully participating agencies which are stored, garaged, or operated within the defined mandatory use service area of a fleet management system shall also be consolidated into and operated under the control of that system.

(f) Fleet management systems established under this subpart provide for furnishing motor vehicles and related services to executive agencies. So far as practicable, these services will also be furnished to any mixed-ownership corporation, the District of Columbia, or a contractor authorized under the provisions of Federal Acquisition Regulation, 48 CFR part 51, subpart 51.2, upon request. Such services may be furnished, as determined by the Administrator, GSA, through the use, under rental or other arrangements, of motor vehicles of private fleet operators, commercial companies, local or interstate common carriers, or Government-owned motor vehicles, or combinations thereof.

[51 FR 11023, Apr. 1, 1986, as amended at 56 FR 59887, Nov. 26, 1991]

§ 101-39.101 Notice of intention to begin a study.

The Administrator, GSA, will ascertain the possibilities of economies to be derived through the establishment of a fleet management system in a specific geographical area. After preliminary investigation, he or she will notify the head of each agency concerned at least 30 calendar days in advance of the intent to conduct a study to develop data and justification as to the feasibility of establishing a fleet management system. The notification, in writing, will include:

(a) The approximate geographical area to be included in the study, including a defined mandatory use service area and an optional use service area; and

(b) The date on which the study will begin.

[51 FR 11023, Apr. 1, 1986, as amended at 56 FR 59887, Nov. 26, 1991]

Federal Property Management Regulations

§ 101-39.103

§ 101-39.101-1 Agency cooperation.

(a) As provided by Executive Order 10579, the head of each executive agency receiving notice that GSA will conduct a study will designate representatives with whom members of the GSA staff may consult and who will furnish information and assistance to the GSA staff, including reasonable opportunities to observe motor vehicle operations and facilities and to examine pertinent cost and other records. Such information shall include the inventory, management, operation, maintenance, and storage of motor vehicles, motor vehicle facilities, and motor vehicle services in the area, including location, use, need, cost, and personnel involved.

(b) In the absence of recorded information, GSA will assist in preparing agency estimates, if requested, or will develop the necessary data.

§ 101-39.102 Determinations.

Each determination to establish a fleet management system will include:

(a) A description of the proposed operation (including Government-owned vehicles operated by contractors) covering the types of service and the geographic area (including the defined mandatory and optional use service areas) and executive agencies or parts of agencies to be served;

(b) The name of the executive agency designated to be responsible for operating the fleet management system and the reason for such designation;

(c) A statement indicating the motor vehicles and related equipment and supplies to be transferred and the amount of reimbursement, if any, to be made; and

(d) An analytical justification to accompany each determination, including a comparison of estimated costs of the present and proposed methods of operation, an estimate of the savings to be realized through the establishment of the proposed fleet management system, a description of the alternatives considered in making the determination, a statement concerning the availability of privately owned facilities and equipment, and the feasibility and estimated cost (immediate

and long-term) of using such facilities and equipment.

[51 FR 11023, Apr. 1, 1986, as amended at 56 FR 59887, Nov. 26, 1991]

§ 101-39.102-1 Records, facilities, personnel, and appropriations.

(a) If GSA decides to establish a fleet management system, GSA, with the assistance of the agencies concerned, will prepare and present to the Director, OMB, a schedule of those records, facilities, personnel, and appropriations, if any, that are proposed for transfer to the fleet management system. The Director, OMB, will determine the records, facilities, personnel, and appropriations, if any, to be transferred.

(b) The Administrator of General Services will furnish a copy of each determination, with a copy of the schedule of proposed transfer of motor vehicles, records, facilities, personnel, and appropriations, to the Director, OMB, and to each agency affected.

[51 FR 11023, Apr. 1, 1986, as amended at 56 FR 59887, Nov. 26, 1991]

§ 101-39.102-2 Effective date of determination.

Unless a longer time is allowed, any determination made by the Administrator, GSA, shall become binding on all affected executive agencies 45 calendar days after issuance, except with respect to any agency which appeals or requests an exemption from any determination in accordance with § 101-39.103.

§ 101-39.103 Agency appeals.

(a) Any executive agency may appeal or request exemption from any or all proposals affecting it which are contained in a determination. Appeals shall be submitted, in writing, within 45 calendar days from the date of the determination to the Director, OMB, with a copy to the Administrator of GSA. Appeals shall be accompanied by factual and objective supporting data and justification.

(b) The Director, OMB, will review any determination which an executive agency has appealed and will make a final decision on that appeal. The Director, OMB, will decide within 75 calendar days after he or she receives the

§ 101-39.104

appeal, or as soon thereafter as practicable, on the basis of information contained in GSA's determination, the executive agency appeal, and any supplementary data submitted by GSA and the contesting agency. The Director, OMB, will send copies of decisions to GSA and to the heads of other executive agencies concerned.

(c) With reference to each appeal, the decision of the Director, OMB, if he or she holds that the GSA's determination shall apply in whole or in part to the appealing agency, will state the extent to which the determination applies and the effective date of its application. To the extent that the decision on an appeal does not uphold GSA's determination, the determination will be of no force and effect.

§ 101-39.104 Notice of establishment of a fleet management system.

GSA will inform each affected agency of the time schedule for establishment of a fleet management system and of the agency's responsibility for transferring personnel, motor vehicles, maintenance, storage and service facilities, and other involved property. Arrangements will be made for discussions at the local level between the agencies concerned and the agency responsible for operating the fleet management system in order to work out any problems pertaining to establishing and operating fleet management systems.

§ 101-39.104-1 Consolidations into a fleet management system.

(a) All Government-owned motor vehicles acquired by executive agencies for official purposes which are operated, stored, or garaged within a defined mandatory use service area of an established fleet management system and other related equipment and supplies shall, when requested by the Administrator, GSA, in accordance with a determination, be transferred to the control and the responsibility of the fleet management system. Those vehicles specifically exempt by:

- (1) Section 101-39.106 and § 101-39.107,
- (2) In the determination establishing the fleet management system,
- (3) A subsequent determination by the Administrator, GSA, or

41 CFR Ch. 101 (7-1-01 Edition)

(4) The decision of the Director, OMB,

are not required to be transferred into the fleet management system. Facilities, personnel, records, and appropriations, as determined by the Director, OMB, pursuant to § 101-39.102-1, shall be included in the transfer.

(b) Transfers of Government-owned motor vehicles to the control and responsibility of the fleet management system shall be accomplished with transfer forms of the transferring agency or forms furnished by GSA. Each transferring agency shall:

(1) Prepare a transfer document listing each vehicle to be transferred;

(2) Forward a signed copy to the Controller, Federal Supply Service, GSA;

(3) Furnish two copies of the transfer document to the fleet management system receiving the vehicles; and

(4) Forward an additional copy of the transfer document to the fleet management system, when a signed receipt is required by the transferring agency.

[51 FR 11023, Apr. 1, 1986, as amended at 56 FR 59887, Nov. 26, 1991]

§ 101-39.104-2 Reimbursement.

Reimbursement for the motor vehicles and related equipment and supplies acquired by agencies through expenditure made from and not previously reimbursed to any revolving or trust fund authorized by law, shall be made by GSA in an amount equal to the fair market value of the vehicle, equipment, or supplies so taken over, as required by law (40 U.S.C. 491(g)).

§ 101-39.105 Discontinuance or curtailment of service.

(a) If, during any reasonable period not exceeding 2 successive fiscal years, no economies or efficiencies are realized from the operation of any fleet management system, the Administrator, GSA, will discontinue the fleet management system concerned.

(b) The Administrator, GSA, may discontinue or curtail a fleet management system when he or she determines that sufficient economies or efficiencies have not resulted from the operation of that fleet management system. The Administrator, GSA, will give at least 60 calendar days notice of his or her intent to the heads of executive agencies

Federal Property Management Regulations

§ 101-39.107

affected and to the Director, OMB, before taking action.

[56 FR 59888, Nov. 26, 1991]

§ 101-39.105-1 Transfers from discontinued or curtailed fleet management systems.

When a fleet management system is discontinued or curtailed, transfers of vehicles and related equipment and supplies, personnel, records, facilities, and funds as may be appropriate will be made, subject to the approval of the Director, OMB. Reimbursement for motor vehicles and related equipment and supplies acquired by GSA through expenditure made from, and not previously reimbursed to the General Supply Fund, or any revolving or trust fund authorized by law, shall be made by the agency receiving the motor vehicles and related equipment and supplies in an amount equal to the fair market value, as required by law (40 U.S.C. 491(g)).

§ 101-39.105-2 Agency requests to withdraw participation.

(a) Executive agencies receiving motor vehicle services from fleet management systems may request discontinuance or curtailment of their participation after 1 year of participation, unless a different time period has been mutually agreed to, or if the need for these services ceases. Requests shall be submitted to the Administrator, GSA, with factual justification.

(b) If the Administrator, GSA, does not agree with these requests and is unable to make arrangements which are mutually acceptable to GSA and the agency concerned, the agency's request for discontinuance or modification and the explanation of the Administrator, GSA, denying the request will be forwarded to the Director, OMB, who will make the final and binding decision.

[51 FR 11023, Apr. 1, 1986, as amended at 56 FR 59888, Nov. 26, 1991]

§ 101-39.106 Unlimited exemptions.

Unlimited exemptions from inclusion in the fleet management system are granted to the specific organizational units or activities of executive agencies listed below. Unlimited exemp-

tions do not preclude agencies from requesting fleet management services, if available, under optional use arrangements. Such optional use services must be authorized under the provisions of Executive Order 10579 and 40 U.S.C. 472.

(a) Any motor vehicle regularly used by an agency in the performance of investigative, law enforcement, or intelligence duties if the head of that agency or designee makes a determination, in writing (a copy of which shall be forwarded to the Administrator of General Services), that the exclusive control of such vehicles is essential to the effective performance of those duties. Vehicles regularly used for common administrative purposes not directly connected with the performance of law enforcement, investigative, or intelligence duties shall not be exempted from inclusion.

(b) Motor vehicles designed or used for military field training, combat, or tactical purposes, or used principally within the confines of a regularly established military installation.

(c) Any motor vehicle exempted from the display of conspicuous identification by the Administrator, GSA, when identification as a Government vehicle would interfere with the purpose for which it is acquired and used.

(d) Unless inclusion is mutually agreed upon by the Administrator, GSA, and the head of the agency concerned:

(1) Motor vehicles for the use of the heads of the executive agencies, ambassadors, ministers, charges d'affaires, and other principal diplomatic and consular officials.

(2) Motor vehicles regularly and principally used for the transportation of diplomats and representatives of foreign countries or by officers of the Department of State for the conduct of official business with representatives of foreign countries.

(3) Motor vehicles regularly used by the United States Postal Service for the distribution and transportation of mail.

[51 FR 11023, Apr. 1, 1986, as amended at 56 FR 59888, Nov. 26, 1991]

§ 101-39.107 Limited exemptions.

The Administrator, GSA, may exempt those vehicles which, because of

§ 101-39.200

their design or the special purposes for which they are used, cannot, advantageously be incorporated in the fleet management system, if the exemption has been mutually agreed upon by the Administrator and the head of the executive agency concerned. Limited exemption will normally be restricted to:

(a) *Special-purpose motor vehicles.* Motor vehicles acquired for special purposes and which, because of special design, use, or fixed special equipment, cannot advantageously be included in a consolidated operation; or

(b) *Motor vehicles operated outside the defined geographical area of the fleet management system.* Motor vehicles which are operated almost entirely outside the defined mandatory use area of the fleet management system.

[51 FR 11023, Apr. 1, 1986, as amended at 56 FR 59888, Nov. 26, 1991]

Subpart 101-39.2—GSA Interagency Fleet Management System Services

§ 101-39.200 Scope.

This subpart defines the procedures for acquiring motor vehicles and related services provided by the General Services Administration (GSA) Interagency Fleet Management System (IFMS). Local transportation services for Government personnel and property may be provided by the GSA IFMS to efficiently meet the authorized requirements of participating agencies. These services may be furnished through commercial rental companies, private sector fleet operators, local or interstate common carriers, the Government, or a combination of the above.

[56 FR 59888, Nov. 26, 1991]

§ 101-39.201 Services available.

GSA Interagency Fleet Management System (IFMS) vehicles and services shall be used in connection with official business and incidental use as prescribed by rule by the head of the agency in conformance with section 503 of the Ethics Reform Act of 1989 (Pub. L. 101-194) only. Available GSA IFMS services may include any or all of the following:

41 CFR Ch. 101 (7-1-01 Edition)

(a) Motor vehicles for indefinite assignment;

(b) Commercial motor vehicles for daily or short-term use, exclusive of temporary duty requirements;

(c) GSA IFMS dispatch vehicles for short-term use, where available. This service is generally limited to locations where there is no commercial alternative;

(d) Shuttle run or similar services;

(e) Driver services; and

(f) Other related services, including servicing, fueling, and storage of motor vehicles.

[56 FR 59888, Nov. 26, 1991]

§ 101-39.202 Contractor authorized services.

(a) Authorized contractors and subcontractors shall use related GSA Interagency Fleet Management System (IFMS) services solely for official purposes.

(b) To the extent available, authorized contractors and subcontractors may use GSA IFMS services on a reimbursable basis to provide maintenance, repair, storage, and service station services for Government-owned or -leased equipment which is not controlled by a GSA IFMS fleet management center, or for authorized contractor-owned or -leased equipment used exclusively in the performance of Government contracts.

(c) Contractor use of GSA IFMS services will be allowable only to the extent provided in Federal Acquisition Regulation, 48 CFR part 51, subpart 51.2.

(d) Use of GSA IFMS vehicles in the performance of a contract other than a cost-reimbursement contract requires preapproval by the Administrator of GSA. Such requests shall be submitted through the Director, Fleet Management Division, GSA, Attn: FBF, Washington, DC 20406.

[56 FR 59888, Nov. 26, 1991]

§ 101-39.203 Obtaining motor vehicles for short-term use.

Any participating Federal agency, bureau, or activity may obtain vehicles for short-term local use through the GSA Interagency Fleet Management

System (IFMS). Short-term use vehicles may be provided through Military Traffic Management Command (MTMC) agreements with commercial firms or, where available, through GSA IFMS dispatch services. This support is available for official use performed locally or within commuting distance of an employee's designated post of duty. Arrangements for these vehicles will be made by the GSA IFMS fleet management center serving the local area. The requesting agency official or employee must be authorized to place orders for vehicle support and provide a complete billing address and GSA billed office address code (BOAC) at the time an order is placed. Agencies requiring a BOAC may obtain one by contacting any General Services Administration IFMS fleet management center.

[56 FR 59888, Nov. 26, 1991]

§ 101-39.203-1 Obtaining motor vehicles while on temporary duty (TDY) travel.

Federal employees on TDY requiring short-term use of vehicles in the destination area shall obtain service directly from the appropriate sources listed in the Federal Travel Directory (available from the Superintendent of Documents, Government Printing Office, Washington, DC 20402).

§ 101-39.204 Obtaining motor vehicles for indefinite assignment.

Motor vehicles and related services of the GSA Interagency Fleet Management System (IFMS) are provided to requesting agencies under the following procedures. When competing requests are received, priority will be given to a fully participating agency over an other than fully participating agency.

(a) Federal agencies or parts thereof that meet the following conditions are considered fully participating:

(1) All agency-owned motor vehicles have been consolidated into the supporting GSA IFMS fleet management center, and no agency-owned vehicles, with the exception of approved exemptions, are operated in the defined mandatory use service area of the supporting GSA fleet management center;

(2) No vehicles were available to consolidate, but total reliance is placed on

the supporting GSA IFMS fleet management center or the GSA IFMS as a whole to meet all motor vehicle requirements, and no agency-owned vehicles are operated in the defined mandatory use service area of the supporting GSA fleet management center;

(3) The agency would otherwise qualify under paragraph (a) (1) or (2) of this section but has been authorized by GSA to purchase or commercially lease motor vehicles because the GSA IFMS was unable to supply its requirements.

(b) Fully participating agencies may request indefinite assignment of vehicles, regardless of number, from the supporting IFMS fleet management center. Assignment may be made at that level, subject to availability. If the required vehicles are not available, a written request shall be sent to the General Services Administration, Attn: FBF, Washington, DC, 20406. To be considered, the request shall include the following:

(1) Certification that concurrence has been obtained from the designated agency fleet manager or other designated headquarters-level official and that other means of transportation are not feasible or cost-effective;

(2) The number and types of vehicles required, of which passenger vehicles are limited to compact or smaller unless the agency head or designee has certified that larger vehicles are essential to the agency's mission;

(3) Location where the vehicles are needed;

(4) Date required, including earliest and latest acceptable dates;

(5) Anticipated length of assignment;

(6) Projected utilization, normally in terms of miles per month or year;

(7) Certification of funding;

(8) Billing address and billed office address code (BOAC);

(9) Agency contact, including name, address, and telephone number;

(10) Office, program, or activity requiring the vehicles;

(11) A statement that the agency does or does not request authority to commercially lease, and the anticipated duration of the lease, should GSA be unable to provide the vehicles.

(c) Federal agencies that meet the following conditions are considered other than fully participating:

§ 101-39.205

(1) Vehicles have been acquired from other sources for reasons other than the inability of the GSA IFMS to supply the required vehicles, except those designated as exempt vehicles as determined by the GSA IFMS;

(2) Cost reimbursable contractors authorized to utilize GSA IFMS motor vehicles when they represent participating agencies;

(3) Other authorized users of the GSA IFMS.

(d) Other than fully participating agencies must contact the supporting GSA IFMS fleet management center to ascertain vehicle availability, regardless of the number required. If the vehicles are available, assignment shall be made. When the supporting GSA IFMS fleet management center determines that the requested vehicles are not available, the requesting activity shall make a record of contact to document compliance with the mandatory first source of supply requirement. No further authorizations from GSA are required for the agency to execute a commercial lease from sources established by the GSA Automotive Commodity Center or the agency, provided that such agency has Congressional authority to lease motor vehicles and:

(1) All applicable procurement regulations (e.g., Federal Acquisition Regulation (FAR)) and internal agency acquisition regulations are observed;

(2) The requirements of part 101-38 of this chapter regarding fuel economy, Government identification and marking, etc., are adhered to;

(3) The agency fleet manager or designee retains responsibility for fleet oversight and reporting requirements under Public Law 99-272; and

(4) Other than fully participating agencies that choose not to commercially lease may utilize the procedures for full participants in paragraph (b) of this section, on the understanding that fully participating agencies will receive priority consideration.

[56 FR 59888, Nov. 26, 1991]

§ 101-39.205 [Reserved]

§ 101-39.206 Seasonal or unusual requirements.

Agencies or activities having seasonal, peak, or unusual requirements

41 CFR Ch. 101 (7-1-01 Edition)

for vehicles or related services shall inform the GSA IFMS fleet management center as far in advance as possible. Normally, notice shall be given not less than 3 months in advance of the need. Requests for vehicles for other than indefinite assignment will usually be filled for agencies participating fully with the GSA IFMS, provided resources permit. Other than fully participating agencies will normally not be accommodated for seasonal, peak, or unusual vehicle requirements.

[56 FR 59889, Nov. 26, 1991]

§ 101-39.207 Reimbursement for services.

(a) GSA Regional Administrators will issue, as appropriate, regional bulletins announcing the GSA vehicle rental rates applicable to their respective regions.

(b) The using agency will be billed for GSA Interagency Fleet Management System (IFMS) services provided for under this part at rates fixed by GSA. Such rates are designed to recover all GSA IFMS fixed and variable costs. Rates will be reviewed and revised periodically to determine that reimbursement is sufficient to recover applicable costs. Failure by using agencies to reimburse GSA for vehicle services will be cause for GSA to terminate motor vehicle assignments.

(c) IFMS services provided to authorized Government contractors and subcontractors will be billed to the responsible agency unless such agency requests that the contractor be billed directly. In case of nonpayment by a contractor, GSA will bill the responsible agency which authorized the contractor's use of GSA IFMS services.

(d) Using agencies will be billed for accidents and incidents as described in § 101-39.406. Agencies may also be charged administrative fees when vehicles are not properly maintained, repaired, or when the vehicle is subject to abuse or neglect.

(e) Agencies may be charged for recovery of expenses for repairs or services to GSA IFMS vehicles which are not authorized by the GSA IFMS either through preventive maintenance notices, approval from a GSA Maintenance Control Center, or approval from a GSA fleet management center, per

Federal Property Management Regulations

§ 101-39.300

instructions in the operator's guide issued with each vehicle. Excess costs relating to the failure to utilize self-service gasoline pumps or the unnecessary use of premium grade gasoline may also be recovered from using agencies (see §101-38.401-2 of this chapter).

[56 FR 59889, Nov. 26, 1991]

§ 101-39.208 Vehicles removed from defined areas.

(a) Normally, vehicles shall not be permanently operated outside the geographical area served by the issuing GSA IFMS fleet management center. However, when agency programs necessitate vehicle relocation for a period exceeding 90 calendar days, the agency shall notify the issuing GSA IFMS fleet management center of the following:

- (1) The location at which the vehicles are currently in use;
- (2) The date the vehicles were moved to the present location; and
- (3) The expected date the vehicles will be returned to the original location.

(b) When vehicles will be permanently relocated outside the area served by the issuing GSA IFMS fleet management center, the affected GSA IFMS fleet manager will ascertain if the using agency is fully participating at the new location (see §101-39.204). If this criterion is met, the vehicle will normally be transferred to the GSA IFMS fleet management center nearest the new location. If the agency is other than a full participant, the transfer will be treated as a request for additional vehicles at the new location.

[56 FR 59890, Nov. 26, 1991]

Subpart 101-39.3—Use and Care of GSA Interagency Fleet Management System Vehicles

§ 101-39.300 General.

(a) The objective of the General Services Administration (GSA) Interagency Fleet Management System (IFMS) is to provide efficient and economical motor vehicle and related services to participating agencies. To attain this objective, policies and procedures for use and care of GSA IFMS vehicles pro-

vided to an agency or activity are prescribed in this subpart.

(b) To operate a motor vehicle furnished by the GSA IFMS, civilian employees of the Federal Government shall have a valid State, District of Columbia, or Commonwealth operator's license for the type of vehicle to be operated and some form of agency identification. Non-Government personnel, such as contractors, shall have a valid license for the type of equipment to be operated when using vehicles supplied by the GSA IFMS (this may include a Commercial Driver's License). All other vehicle operators, and Federal civilian employees that have a valid civilian operator's license, but not for the type of equipment to be operated, must have in their possession an Optional Form 346, U.S. Government Motor Vehicle Operator's Identification Card, for the type of equipment to be operated. Specific regulations covering procedures and qualifications of Government motor vehicle operators are contained in 5 CFR part 930, issued by the Office of Personnel Management.

(c) To operate a motor vehicle furnished by GSA, drivers and occupants shall wear safety belts whenever the vehicle is in operation. The vehicle operator shall ensure that all vehicle occupants are wearing their safety belts prior to operating the vehicle.

(d) The use of tobacco products is prohibited in GSA IFMS motor vehicles. The agency to which the vehicle is assigned is responsible for ensuring that its employees do not use tobacco products while occupying IFMS vehicles. If a user agency violates this prohibition, the agency will be charged for the cost of cleaning the affected vehicle(s) beyond normal detailing procedures to remove tobacco odor or residue or repairing damage caused as a result of tobacco use. The decision to perform such additional cleaning or repair will be made by the GSA fleet manager based upon the condition of the vehicle when assigned, the degree of tobacco residue and damage, and the cost effectiveness of such additional cleaning.

(e) Reasonable diligence in the care of GSA IFMS vehicles shall be exercised by using agencies and operators

§ 101-39.301

at all times. Officials or employees failing to take proper care of motor vehicles issued to them may be refused further authorization to use GSA IFMS vehicles after reasonable notice has been provided by GSA to the head of the local activity concerned.

[56 FR 59890, Nov. 26, 1991, as amended at 58 FR 63532, Dec. 2, 1993]

§ 101-39.301 Utilization guidelines.

An agency must be able to justify a full-time vehicle assignment. The following guidelines may be employed by an agency requesting GSA Interagency Fleet Management System (IFMS) services. Other utilization factors, such as days used, agency mission, and the relative costs of alternatives to a full-time vehicle assignment, may be considered as justification where miles traveled guidelines are not met.

(a) *Passenger-carrying vehicles.* The utilization guidelines for passenger-carrying vehicles are a minimum of 3,000 miles per quarter or 12,000 miles per year.

(b) *Light trucks and general purpose vehicles.* The utilization guidelines for light trucks and general purpose vehicles are as follows:

(1) *Light trucks and general purpose vehicles, 12,500 lbs.* Gross Vehicle Weight Rating (GVWR) and under—10,000 miles per year.

(2) *Trucks and general purpose vehicles, over 12,500 lbs.* GVWR to 24,000 lbs. GVWR—7,500 miles per year.

(c) *Heavy trucks and truck tractors.* The utilization guidelines for heavy trucks and truck tractors are as follows:

(1) *Heavy trucks and general purpose vehicles over 24,000 lbs.* GVWR—7,500 miles per year.

(2) *Truck tractors*—10,000 miles per year.

(d) *Other trucks and special purpose vehicles.* Utilization guidelines for other trucks and special purpose vehicles have not been established. However, the head of the local office of the agency or his/her designee shall cooperate with GSA IFMS fleet management center personnel in studying the use of this equipment and take necessary action to ensure that it is reasonably uti-

41 CFR Ch. 101 (7-1-01 Edition)

lized or returned to the issuing GSA IFMS fleet management center.

[51 FR 11023, Apr. 1, 1986, as amended at 56 FR 59890, Nov. 26, 1991; 58 FR 63533, Dec. 2, 1993]

§ 101-39.302 Rotation.

GSA Interagency Fleet Management System (IFMS) vehicles on high mileage assignments may be rotated with those on low mileage assignments to assure more uniform overall fleet utilization. In cases where the continued use of a vehicle is essential but its miles traveled are not consistent with utilization guidelines, the using agency may be required to justify, in writing, retention of the vehicle. Each GSA IFMS fleet manager will decide on a case-by-case basis which vehicles, if any, will be rotated based upon vehicle type, vehicle location, location and availability of replacement vehicles, and the mission of the using agency.

[56 FR 59890, Nov. 26, 1991]

§ 101-39.303 Maintenance.

In order to ensure uninterrupted operation of GSA Interagency Fleet Management System (IFMS) vehicles, safety and preventive maintenance inspections will be performed at regularly scheduled intervals as directed by GSA. Users of GSA IFMS vehicles shall comply with the safety and preventive maintenance notices and instructions issued for the vehicle.

[56 FR 59890, Nov. 26, 1991]

§ 101-39.304 Modification or installation of accessory equipment.

The modification of a GSA Interagency Fleet Management System (IFMS) vehicle or the permanent installation of accessory equipment on these vehicles may be accomplished only when approved by GSA. For the purpose of this regulation, permanent installation means the actual bolting, fitting, or securing of an item to the vehicle. Such modification or installation of accessory equipment must be considered by the agency as essential for the accomplishment of the agency's mission. The request for such modification or installation shall be forwarded to the appropriate GSA IFMS regional

Federal Property Management Regulations

§ 101-39.401

fleet manager for consideration. Accessory equipment or other after-market items which project an inappropriate appearance, such as radar detectors, will not be used on GSA IFMS vehicles. Decorative items (i.e., bumper stickers and decals) will not be used on IFMS vehicles unless authorized by the Director, Fleet Management Division, GSA.

[56 FR 59890, Nov. 26, 1991]

§ 101-39.305 Storage.

(a) GSA Interagency Fleet Management System (IFMS) vehicles shall be stored and parked at locations which provide protection from pilferage or damage. In the interest of economy, no cost storage shall be used whenever practicable and feasible.

(b) The cost of parking and storing GSA IFMS vehicles is the responsibility of the using agency. Prior to the procurement of other than temporary parking accommodations in urban centers (see § 101-18.102), agencies shall determine the availability of Government-owned or -controlled parking space in accordance with the provisions of § 101-17.101-6.

[56 FR 59890, Nov. 26, 1991]

§ 101-39.306 Operator's packet.

The GSA Interagency Fleet Management System (IFMS) will provide each system vehicle with an operator's packet containing the following information and instructions. This information should remain in the vehicle at all times, except when inconsistent with authorized undercover operations.

- (a) Driver's responsibilities;
- (b) Requirement of use for official purposes only;
- (c) Instruction for:
 - (1) Acquiring maintenance and repair authorizations;
 - (2) Acquiring emergency supplies, services, and repairs; and
 - (3) Reporting accidents.
- (d) The telephone numbers of responsible GSA IFMS fleet management center employees to be called in case of accident or emergency;
- (e) Instructions on the use of the Standard Form 149, U.S. Government National Credit Card;

(f) List of contractors from which vehicle operators may purchase items authorized by the SF 149, U.S. Government National Credit Card;

(g) Accident reporting kit which contains:

- (1) Standard Form 91, Motor Vehicle Accident Report; and
- (2) Standard Form 94, Statement of Witness.

NOTE: The vehicle operator or assignee shall be personally responsible for safeguarding and protecting the SF 149, U.S. Government National Credit Card.

[51 FR 11023, Apr. 1, 1986, as amended at 56 FR 59891, Nov. 26, 1991; 58 FR 65291, Dec. 14, 1993]

§ 101-39.307 Grounds for withdrawal of vehicle.

GSA may withdraw the issued vehicle from further use by the agency or its contractor if it is determined that the using agency has not complied with the provisions of subpart 101-39.3, that the vehicle has not been maintained in accordance with GSA IFMS maintenance standards, that the vehicle has been used improperly, or that the using agency has not reimbursed GSA for vehicle services. Improper use includes, but is not limited to, credit card abuse and misuse, continued violation of traffic ordinances, at-fault accidents, reckless driving, driving while intoxicated, use for other than official purposes, and incidental use when not authorized by the using agency.

[56 FR 59891, Nov. 26, 1991]

Subpart 101-39.4—Accidents and Claims

§ 101-39.400 General.

Officials, employees, and contractors responsible for the operation of General Services Administration (GSA) Interagency Fleet Management System (IFMS) vehicles shall exercise every precaution to prevent accidents. In case of an accident, the employee or official concerned shall comply with the procedures established by this subpart.

[56 FR 59891, Nov. 26, 1991]

§ 101-39.401 Reporting of accidents.

(a) The operator of the vehicle is responsible for notifying the following

§ 101-39.402

persons immediately, either in person, by telephone, or by facsimile machine of any accident in which the vehicle may be involved:

(1) The manager of the GSA IFMS fleet management center issuing the vehicle;

(2) The employee's supervisor; and

(3) State, county, or municipal authorities, as required by law.

(b) In addition, the vehicle operator shall obtain and record information pertaining to the accident on Standard Form 91, Motor Vehicle Accident Report. Only one copy of the Standard Form 91 is required. When completed, the Standard Form 91 shall be given to the vehicle operator's supervisor. The vehicle operator shall also obtain the names, addresses, and telephone numbers of any witnesses and, wherever possible, have witnesses complete Standard Form 94, Statement of Witness, and give the completed Standard Form 94 and other related information to his or her supervisor. The vehicle operator shall make no statements as to the responsibility for the accident except to his or her supervisor or to a Government investigating officer.

(c) Whenever a vehicle operator is injured and cannot comply with the above requirements, the agency to which the vehicle is issued shall report the accident to the State, county, or municipal authorities as required by law, notify the GSA IFMS fleet manager of the center issuing the vehicle as soon as possible after the accident, and complete and process Standard Form 91. A complete copy of the accident report shall be forwarded to the appropriate GSA office as outlined in the vehicle operator's packet.

[51 FR 11023, Apr. 1, 1986, as amended at 56 FR 59891, Nov. 26, 1991; 58 FR 65291, Dec. 14, 1993]

§ 101-39.402 Recommendations for disciplinary action.

If a vehicle operator fails to report an accident involving a GSA Interagency Fleet Management System (IFMS) vehicle in accordance with §101-39.401, or if the operator has a record showing a high accident frequency or cost, GSA will notify the appropriate official(s) of the operator's agency, and will advise that either fail-

41 CFR Ch. 101 (7-1-01 Edition)

ure to report an accident or poor driving record is considered by GSA to be sufficient justification for the agency to suspend the right of the employee to use a GSA IFMS vehicle.

[56 FR 59891, Nov. 26, 1991]

§ 101-39.403 Investigation.

(a) Every accident involving a GSA Interagency Fleet Management System (IFMS) vehicle shall be investigated and a report furnished to the manager of the GSA IFMS fleet management center which issued the vehicle.

(b) The agency employing the vehicle operator shall investigate the accident within 48 hours after the actual time of occurrence. Also, GSA may investigate any accident involving an IFMS vehicle when deemed necessary. Should such investigation develop additional information, the additional data or facts will be furnished to the using agency for its information.

(c) Two copies of the complete report of the investigation, including (when available) photographs, measurements, doctor's certificate of bodily injuries, police investigation reports, operator's statement, agency's investigation reports, witnesses' statements, the Motor Vehicle Accident Report (SF 91), and any other pertinent data shall be furnished to the manager of the GSA IFMS fleet management center issuing the vehicle.

[51 FR 11023, Apr. 1, 1986, as amended at 56 FR 59891, Nov. 26, 1991; 58 FR 65291, Dec. 14, 1993]

§ 101-39.404 Claims in favor of the Government.

Whenever there is any indication that a party other than the operator of the GSA Interagency Fleet Management System (IFMS) vehicle is at fault and that party can be reasonably identified, the agency responsible for investigating the accident shall submit all original documents and data pertaining to the accident and its investigation to the servicing GSA IFMS fleet management center. The GSA IFMS regional fleet manager, or his/her representative, will initiate the necessary action to effect recovery of the Government's claim.

[56 FR 59891, Nov. 26, 1991]

Federal Property Management Regulations

§ 101-39.406

§ 101-39.405 Claims against the Government.

(a) Whenever a GSA Interagency Fleet Management System (IFMS) vehicle is involved in an accident resulting in damage to the property of, or injury to, a third party, and the third party asserts a claim against the Government based on the alleged negligence of the vehicle operator (acting within the scope of his or her duties), it shall be the responsibility of the agency employing the person who was operating the GSA IFMS vehicle at the time of the accident to make every effort to settle the claim administratively to the extent that the agency is empowered to do so under the provisions of 28 U.S.C. 2672. It shall be the further responsibility of the agency, in the event that administrative settlement cannot be effected, to prepare completely, from an administrative standpoint, the Government's defense of the claim. The agency shall thereafter transmit the complete case through appropriate channels to the Department of Justice.

(b) Except for the exclusions listed in § 101-39.406, the agency employing the vehicle operator shall be financially responsible for damage to a GSA IFMS vehicle.

(c) If a law suit is filed against the agency using a GSA Interagency Fleet Management System (IFMS) vehicle, the agency shall furnish the appropriate GSA Regional Counsel with a copy of all papers served in the action. When requested, GSA's Regional Counsel will cooperate with and assist the using agency and the Department of Justice in defense of any action against the United States, the using agency, or the operator of the vehicle, arising out of the use of a GSA IFMS vehicle.

[56 FR 59891, Nov. 26, 1991]

§ 101-39.406 Responsibility for damages.

(a) GSA will charge the using agency all costs resulting from damage, including vandalism, theft, and parking lot damage, to a GSA Interagency Fleet Management System (IFMS) vehicle which occurs during the period that the vehicle is assigned or issued to that agency, to an employee of that

agency, or to the agency's authorized contractor; however, the using agency will not be held responsible for damages to the vehicle if it is determined by GSA, after a review on a case by case basis of the documentation required by § 101-39.401, that damage to the vehicle occurred:

(1) As a result of the negligent or willful act of a party other than the agency (or the employee of that agency) to which the vehicle was assigned or issued and the identity of the party can be reasonably determined;

(2) As a result of mechanical failure of the vehicle, and the using agency (or its employee) is not otherwise negligent. Proof of mechanical failure must be submitted; or

(3) As a result of normal wear and tear such as is expected in the operation of a similar vehicle.

(b) Agencies using GSA IFMS services will be billed for the total cost of all damages resulting from neglect or abuse of assigned or issued GSA IFMS vehicles.

(c) If an agency is held responsible for damages, GSA will charge to that agency all costs for removing and repairing the GSA IFMS vehicle. If the vehicle is damaged beyond economical repair, GSA will charge all costs to that agency, including fair market value of the vehicle less any salvage value. Upon request, GSA will furnish an accident report, where applicable, regarding the incident to the agency. Each agency shall be responsible for disciplining its employees who are guilty of damaging GSA IFMS vehicles through misconduct or improper operation, including inattention.

(d) If an agency has information or facts that indicate that it was not responsible for an accident, the agency may furnish the data to GSA requesting that costs charged to and collected from it be credited to the agency. GSA will make the final determination of agency responsibility based upon Government findings, police accident reports, and any available witness statements.

(e) When contractors or subcontractors of using agencies are in accidents involving GSA IFMS vehicles, the agency employing the contractor will usually be billed directly for all costs

§ 101-39.407

associated with the accident. It will be the responsibility of the using agency to collect accident costs from the contractor should the contractor be at fault.

[56 FR 59892, Nov. 26, 1991]

§ 101-39.407 Accident records.

If GSA's records of vehicle accidents indicate that a particular activity has had an unusually high accident frequency rate or a high accident cost per mile, GSA will so advise the using activity. Corrective action will be requested and GSA will cooperate in any reasonable manner possible to bring about improved performance.

**Subparts 101-39.5—101-39.48
[Reserved]**

Subpart 101-39.49—Forms

§ 101-39.4900 Scope of subpart.

This subpart provides the means for obtaining forms prescribed or available for use in connection with subject matter covered in part 101-39.

[56 FR 59892, Nov. 26, 1991]

§ 101-39.4901 Obtaining standard and optional forms.

Standard and optional forms referenced in part 101-39 may be obtained through the General Services Administration, Inventory and Requisition Management Branch, Attn: FCNI, Washington, DC 20406, or through regional GSA Federal Supply Service Bureaus. GSA regional offices will provide

41 CFR Ch. 101 (7-1-01 Edition)

support to requesting activities needing forms.

[56 FR 59892, Nov. 26, 1991]

PART 101-40—TRANSPORTATION AND TRAFFIC MANAGEMENT

AUTHORITY: 40 U.S.C. 486(c); Sec. 205(c), 63 Stat. 390.

SOURCE: 65 FR 60060, Oct. 6, 2000, unless otherwise noted.

§ 101-40.000 Cross-reference to the Federal Management Regulation (FMR) (41 CFR chapter 102, parts 102-1 through 102-220).

For information on transportation and traffic management previously contained in this part, see FMR part 117 (41 CFR part 102-117).

PART 101-41—TRANSPORTATION DOCUMENTATION AND AUDIT

AUTHORITY: 31 U.S.C. 3726; and 40 U.S.C. 486(c).

SOURCE: 65 FR 24568, Apr. 26, 2000, unless otherwise noted.

§ 101-41.000 Cross-reference to the Federal Management Regulation (FMR) (41 CFR chapter 102, parts 102-1 through 102-220).

For transportation payment and audit policy, see FMR part 102-118 (41 CFR part 102-118).

APPENDIX TO SUBCHAPTER G—
TEMPORARY REGULATIONS [RESERVED]

SUBCHAPTER H—UTILIZATION AND DISPOSAL

PART 101-42—UTILIZATION AND DISPOSAL OF HAZARDOUS MATERIALS AND CERTAIN CATEGORIES OF PROPERTY

Sec.

- 101-42.000 Scope of part.
- 101-42.001 Definitions of terms.
- 101-42.002 Requests for deviations.

Subpart 101-42.1 [Reserved]

Subpart 101-42.2—Utilization of Hazardous Materials and Certain Categories of Property

- 101-42.200 Scope of subpart.
- 101-42.201 [Reserved]
- 101-42.202 Identification of hazardous materials.
- 101-42.203 Reassignment of hazardous materials.
- 101-42.204 Reporting requirements.
- 101-42.205 Exceptions to reporting.
- 101-42.206 Special requirements for utilization of hazardous materials and certain categories of property.
- 101-42.207 Transfer of hazardous materials and certain categories of property.
- 101-42.208 Custody of hazardous materials.
- 101-42.209 Cost of care and handling of hazardous materials and certain categories of property.

Subpart 101-42.3—Donation of Hazardous Materials and Certain Categories of Property

- 101-42.300 Scope of subpart.
- 101-42.301 General.
- 101-42.302 Responsibilities for donation of hazardous materials.
- 101-42.303 Hazardous materials distributed to donees by State agencies.
- 101-42.304 Special requirements for donation of certain hazardous materials.

Subpart 101-42.4—Sale, Abandonment, or Destruction of Surplus Hazardous Materials and Certain Categories of Property

- 101-42.400 Scope of subpart.
- 101-42.401 Sales responsibilities for hazardous materials.
- 101-42.402 Reporting hazardous materials for sale.
- 101-42.403 Sales methods and procedures.
- 101-42.404 Special requirements for the sale of hazardous materials.
- 101-42.405 Transportation of hazardous materials.

- 101-42.406 Abandonment or destruction of surplus hazardous materials and certain categories of property.

Subparts 101-42.5—101-42.10 [Reserved]

Subpart 101-42.11—Special Types of Hazardous Materials and Certain Categories of Property

- 101-42.1100 Scope of subpart.
- 101-42.1101 Federal supply classification (FSC) groups and classes which contain hazardous materials.
- 101-42.1102 Special requirements for utilization, donation, sale, and abandonment or destruction of hazardous materials and certain categories of property.
 - 101-42.1102-1 Asbestos.
 - 101-42.1102-2 Polychlorinated biphenyls.
 - 101-42.1102-3 Controlled substances.
 - 101-42.1102-4 Nuclear Regulatory Commission-controlled materials.
 - 101-42.1102-5 Drugs, biologicals, and reagents other than controlled substances.
 - 101-42.1102-6 Noncertified and certified electronic products.
 - 101-42.1102-7 Lead-containing paint and items bearing lead-containing paint.
 - 101-42.1102-8 United States Munitions List items which require demilitarization.
 - 101-42.1102-9 Acid contaminated and explosive contaminated property.
 - 101-42.1102-10 Firearms.

AUTHORITY: Sec. 205(c), 63 Stat. 390; 40 U.S.C. 486(c).

SOURCE: 57 FR 39121, Aug. 28, 1992, unless otherwise noted.

§ 101-42.000 Scope of part.

This part prescribes the special policies and procedures governing the utilization, donation, sale, exchange, or other disposition of hazardous materials, dangerous property, and other categories of property with special utilization and disposal requirements, located within the United States, the District of Columbia, the Commonwealth of Puerto Rico, American Samoa, Guam, the Commonwealth of the Northern Mariana Islands, the Trust Territory of the Pacific Islands, and the Virgin Islands.

§ 101-42.001 Definitions of terms.

For the purposes of this part 101-42, the following terms shall have the meaning set forth below:

Acid contaminated property means property that may cause burns or toxicosis when improperly handled due to acid residues adhering to or trapped within the material.

Biologicals means hazardous materials which are of or pertain to the products and operations of applied biology, or any biochemical products, especially serums, vaccines, etc., produced from microorganisms.

Certified electronic product means any electronic product which bears the manufacturer's certification label or tag (21 CFR 1010.2) indicating that the product meets applicable radiation safety performance standards prescribed by the Food and Drug Administration under 21 CFR part 1020.

Controlled substances means:

(a) Any narcotic, depressant, stimulant, or hallucinogenic drug, or any other drug, other substance, or immediate precursor included in Schedules I, II, III, IV, or V of section 202 of the Controlled Substance Act (21 U.S.C. 812) except exempt chemical preparations and mixtures, and excluded substances listed in 21 CFR part 1308;

(b) Any other drug or substance that the Attorney General determines to be subject to control pursuant to Subchapter I of the Controlled Substance Act (21 U.S.C. 801 *et seq.*); or

(c) Any other drug or substance that by international treaty, convention, or protocol is to be controlled by the United States.

Explosive contaminated property means property that may ignite or explode when exposed to shock, flame, sparks, or other high temperature sources due to residual explosive material in joints, angles, cracks, or around bolts.

Extremely hazardous material means:

(a) Those materials which are hazardous to the extent that they generally require special handling such as licensing and training of handlers, protective clothing, and special containers and storage.

(b) Those materials which, because of their extreme flammability, toxicity, corrosivity or other perilous qualities, could constitute an immediate danger or threat to life and property and which usually have specialized uses under controlled conditions.

(c) Those materials which have been determined by the holding agency to endanger public health or safety or the environment if not rendered innocuous before release to other agencies or to the general public.

Firearms means any weapons (including flare and starter guns) which will, or are designed to, or may be readily converted to expel a projectile by the action of an explosive, the frame or receiver of any such weapons, or any muffler or silencer for such purposes. For purposes of this Part 101-42, firearms are considered to be dangerous property.

Hazardous material means property that is deemed a hazardous material, chemical substance or mixture, or hazardous waste under the Hazardous Materials Transportation Act (HMTA), the Resource Conservation and Recovery Act (RCRA), or the Toxic Substances Control Act (TSCA). Generally, hazardous materials have one or more of the following characteristics:

(a) Has a flash point below 200 F (93.3 C), closed cup, or is subject to spontaneous heating;

(b) Is subject to polymerization with the release of large amounts of energy when handled, stored, or shipped without adequate controls;

(c) In the course of normal operations, may produce fibers, dusts, gases, fumes, vapors, mists, or smokes which have one or more of the following characteristics:

(1) Causes 50 percent fatalities to test animals below 500 mg/kg of test animal weight when a single oral dose LD50 is used;

(2) Is a flammable solid or a strong oxidizing or reducing agent;

(3) Causes first degree burns to skin in a short time exposure, or is systemically toxic by skin contact;

(4) Has a permissible exposure limit (PEL) below 1000 p/m for gases and vapors, below 500 mg/mm³ for fumes, below 30 mpppcf (10 mg/m³), or 2 fibers/CM³ for dust;

(5) Causes occupational chemical dermatitis, which is any abnormality of the skin induced or aggravated by the work environment which includes but is not limited to primary irritant categories, allergic sensitizers, and photo sensitizers;

Federal Property Management Regulations

§ 101-42.002

(d) Is radioactive to the extent it requires special handling;

(e) Is a recognized carcinogen according to Occupational Safety and Health Administration regulations at 29 CFR part 1910; or

(f) Possesses special characteristics which in the opinion of the holding agency could be hazardous to health, safety, or the environment if improperly handled, stored, transported, disposed of, or otherwise improperly used.

Hazardous waste means those materials or substances, the handling and disposal of which are governed by 40 CFR part 261.

(a) In general, hazardous materials are hazardous wastes when one or both of the following is true:

(1) They have passed through the disposal cycle without having successfully been reutilized, transferred, donated, or sold, and the holding agency declares an intent to discard.

(2) They are no longer usable for their intended purpose, a valid alternate purpose, or resource recovery.

(b) In general, solid (non-hazardous) wastes, as defined at 40 CFR 261.2, become hazardous wastes when:

(1) They exhibit one or more of the characteristics of ignitability, corrosivity, reactivity, or EP toxicity; or

(2) They are predetermined hazardous wastes upon generation as listed in 40 CFR part 261, subpart D.

(c) Hazardous materials having an expired shelf life shall be reclassified as hazardous wastes if required by Federal and/or State environmental laws or regulations. Before such reclassification, the shelf life may be extended if supported by results of tests and recertification performed by authorized personnel in accordance with applicable regulations.

(d) The transportation of hazardous wastes is governed by the regulations issued by the Department of Transportation, codified in 49 CFR part 171 *et seq.*

Lead-containing paint means paint or other similar surface coating material that contains lead or lead compounds in excess of 0.06 percent of the weight of the total nonvolatile content of the paint or the weight of the dried paint film.

Noncertified electronic product means any electronic product for which there is an applicable radiation safety performance standard prescribed or hereafter prescribed by the Food and Drug Administration (FDA) under 21 CFR part 1020, and which the manufacturer has not certified as meeting such standard. The noncertification may be due to either (a) manufacture of the product before the effective date of the standard or (b) the product was exempted from the applicable standard and is so labeled.

Nuclear Regulatory Commission—controlled materials means those materials the possession, use, and transfer of which are subject to the regulatory controls of the Nuclear Regulatory Commission (NRC) pursuant to the Energy Reorganization Act of 1974. The materials are defined as follows:

(a) *Byproduct materials* means any radioactive material (except special nuclear material) yielded in or made radioactive by exposure to the radiation incident to the process of producing or utilizing special nuclear material. (See 10 CFR part 30.)

(b) *Source material* means uranium or thorium, or any combination thereof, in any physical or chemical form, or ores which contain by weight one-twentieth of one percent (0.05%) or more of uranium, thorium, or any combination thereof. Source material does not include special nuclear material. (See 10 CFR part 40.)

(c) *Special nuclear material* means plutonium, uranium 233, uranium enriched in the isotope 233 or in the isotope 235, any other materials which the NRC, pursuant to the Atomic Energy Act of 1954 (68 Stat. 919), including any amendments thereto, determines to be special nuclear material, or any material artificially enriched by any of the foregoing, but does not include source material. (See 10 CFR part 70.)

Reagent means any hazardous material which is used to detect or measure another substance or to convert one substance into another by means of the reactions it causes.

§ 101-42.002 Requests for deviations.

Deviations from the regulations in this part shall only be granted by the Administrator of General Services (or

designee). Requests for deviations shall be made in writing to the General Services Administration (FB), Washington, DC 20406, with complete justification. A copy of the authorizing statement for each deviation, including the nature of the deviation, the reasons for such special action, and the Administrator's or designee's approval, will be available for public inspection under Subpart 105-60.3 of this title.

Subpart 101-42.1 [Reserved]

Subpart 101-42.2—Utilization of Hazardous Materials and Certain Categories of Property

§ 101-42.200 Scope of subpart.

This subpart prescribes the special policies and methods for the utilization and transfer of hazardous materials and other certain categories of property within the Government in addition to the requirements of part 101-43.

§ 101-42.201 [Reserved]

§ 101-42.202 Identification of hazardous materials.

(a) Current acquisition standards (Fed. Std. No. 313 and Fed. Std. No. 123) and the Federal Acquisition Regulation require that manufacturers identify and document potential hazards on material safety data sheets (MSDSs) as part of the acquisition process. Acquisition of MSDSs is also prescribed by the Occupational Safety and Health Administration (OSHA) regulations found in 29 CFR part 1910 and paragraph 1-602(c) of Executive Order 12196, Occupational Safety and Health Programs for Federal Employees, dated February 26, 1980. GSA's Federal Supply Service (4FQ) maintains an automated data base, accessible via modem and computer terminal, that contains MSDSs for all GSA-procured hazardous materials. In addition to display of the MSDS on the terminal screen, the system allows for the addition of the MSDS to the user's local data base and the transmission of the MSDS via facsimile to the user's site. Detailed instructions on how to access this system may be obtained by sending a self-addressed envelope to General Services Administration, Federal Supply Serv-

ice, Attn: MSDS Coordinator, 401 W. Peachtree St., NE, suite 3021, Atlanta, Georgia 30365.

(b) The Hazardous Materials Information System (HMIS) is a collection of MSDS information, transportation information, and disposal information that was established by the Department of Defense to assist personnel who handle, store, ship, use or dispose of hazardous materials. Each record in the data base is defined by a stock number (either national stock number or local numbers), the manufacturer's contractor and Government entity (CAGE) code, and a part number indicator which is linked to the manufacturer's part number or trade name. The data base (DoD 6050.5L) is available on microfiche and compact disc-read only memory (CD-ROM) through the Naval Computer and Telecommunication Area Master Station, Atlantic (NCTAMS LANT), Attn.: Code 911.3, Norfolk, VA 23511-5355.

(c) For items not listed or adequately described in the HMIS or on a MSDS, contact the procuring agency, the manufacturer, or your technical staff for information as to the potential hazards of the item.

(d) Some hazardous items were acquired by Federal agencies prior to implementation of the standards requiring identification of potential hazards. Identification and documentation of the hazardous nature of such items is the responsibility of the owning or holding agency. Hazardous materials are found in most Federal supply classification (FSC) classes. Section 101-42.1101 contains a table of FSC classes composed predominantly of hazardous items and a table of FSC groups and classes which contain a significant number of hazardous items. These tables are designed to assist Federal agencies in reviewing personal property inventories to identify hazardous materials.

(e) When an item has been determined hazardous, the owning Federal agency shall document the accountable inventory record accordingly. If the item has not been appropriately labeled by the manufacturer or distributor, the owning agency shall appropriately label, mark, or tag the

Federal Property Management Regulations

§ 101-42.206

item in accordance with OSHA requirements (29 CFR 1910.1200) regarding the actual or potential hazard associated with the handling, storage, or use of the item to include hazardous chemical(s) contained and the name of the chemical manufacturer, importer, or responsible party as defined at 29 CFR 1910.1200(c). Such information shall be maintained in the item record for use in preparation of reports of excess property, reassignment or transfer documentation, and other documentation requirements that may arise.

§ 101-42.203 Reassignment of hazardous materials.

When hazardous materials are reassigned within an executive agency, information on the actual or potential hazard shall be included in the documentation effecting the reassignment, and the recipient organization shall perpetuate in the inventory or control records visibility of the nature of the actual or potential hazard.

§ 101-42.204 Reporting requirements.

(a) Except as set forth in this 101-42.204, excess personal property which has been identified as hazardous shall be reported promptly in accordance with this part and §101-43.4801, with a complete description of the actual or potential hazard associated with the handling, storage, or use of the item.

(b) If the hazardous characteristics of the item are adequately described on a MSDS or HMIS record (or equivalent), the reporting document should so indicate, and a copy of the MSDS or HMIS record shall be included. If no MSDS or HMIS is available, information must be obtained by the reporting activity and furnished with the reporting document. A certification by a duly authorized agency official that the item has been clearly labeled as prescribed in §101-42.202(e) should be included in the description of the hazard. The agency official must also certify that the containers and/or packaging meet or exceed Department of Transportation specifications for a hazardous material container (49 CFR parts 178-180).

(c) Hazardous wastes shall not be reported to GSA for disposal, and shall be disposed of by the holding agency or the reporting activity only under the

Environmental Protection Agency (EPA) and State and local regulations. Holding agencies shall contact the manufacturer, the agency's technical staff, or the local State EPA office for assistance in this matter if needed.

§ 101-42.205 Exceptions to reporting.

(a) When the actual or potential hazard is such that an item is determined by the holding agency to be extremely hazardous property, the item shall not be reported on Standard Form (SF) 120, Report of Excess Personal Property, unless so directed by a GSA regional office or GSA Central Office. Other items identified as hazardous shall be reported to GSA on SF 120 unless otherwise excepted by §§101-43.304 and 101-43.305.

(b) When an item determined to be extremely hazardous property becomes excess, the holding agency shall notify the appropriate GSA regional personal property office, identify the item, and describe the actual or potential hazard associated with the handling, storage, or use of the item. On a case-by-case basis, the GSA regional office will determine the utilization, donation, sales, or other disposal requirements, and provide appropriate guidance to the holding agency.

(c) When EPA, under its authorities, transfers accountability for hazardous materials to Federal, State, and local agencies, to research institutions, or to commercial businesses to conduct research or to perform the actual cleanup of a contaminated site, the item is not required to be reported.

§ 101-42.206 Special requirements for utilization of hazardous materials and certain categories of property.

Special utilization requirements for certain categories of property are provided in §101-42.1102. Many hazardous materials require special storage and handling. It is the responsibility of the holding agency to properly store hazardous materials and ensure the use of appropriate safeguards such as warning signs, labels, and use of protective clothing and equipment by utilization screeners who are inspecting excess hazardous materials.

§ 101-42.207

§ 101-42.207 Transfer of hazardous materials and certain categories of property.

(a) Excess hazardous materials may be transferred among Federal agencies under §101-43.309-5, except that the Standard Form (SF) 122, Transfer Order Excess Personal Property, or any other transfer order form approved by GSA, shall contain a complete description of the actual or potential hazard associated with the handling, storage, or use of the item. Such description shall consist either of a written narrative, complying with the requirements of 29 CFR 1910.1200, in block 13c or as an addendum, or an MSDS or HMIS data. In the absence of an MSDS, the HMIS data which fulfills the MSDS requirements must be attached if the receiving activity does not have the HMIS readily available. Otherwise, citation to the HMIS shall be provided. A certification by a duly authorized official that the item has been clearly labeled and its packaging meets OSHA and DOT requirements as set forth in §§101-42.202(e) and 101-42.204 respectively, shall be included in the description of the hazard. The transferee shall prepare the SF 122, or any other transfer order form approved by GSA, under §101-43.4901-122.

(b) The transferee agency shall document the inventory or control record of the transferred hazardous item to clearly reflect the actual or potential hazard associated with the handling, storage, or use of the item. If available, an MSDS or a citation or copy of the HMIS data must be filed with the SF 122 or automated requisitions on approved forms. Such visibility shall be maintained in the item record and on the property (labeled) to the extent required by Federal regulations to ensure the continued identification of the item as hazardous material.

§ 101-42.208 Custody of hazardous materials.

Custody of extremely hazardous materials shall be the responsibility of the owning or holding Federal agency. Custody of other hazardous materials may be transferred in whole or in part to another Federal agency with that agency's consent.

41 CFR Ch. 101 (7-1-01 Edition)

§ 101-42.209 Cost of care and handling of hazardous materials and certain categories of property.

The special handling requirements associated with many hazardous materials often increase the cost of care and handling of hazardous materials well above the usual costs incurred while holding excess personal property pending disposition. As provided in §101-43.310-1, each holding agency shall be responsible for, and bear the cost of, care and handling of excess property pending disposition, including those special costs associated with hazardous materials. Only the cost of transportation and handling incurred incident to the transfer of hazardous materials are borne by the transferee agency if billed by the holding agency in accordance with §101-43.309-3.

Subpart 101-42.3—Donation of Hazardous Materials and Certain Categories of Property

§ 101-42.300 Scope of subpart.

This subpart prescribes the special policies and methods governing the donation of hazardous materials and certain categories of property in addition to the requirements of part 101-44.

§ 101-42.301 General.

Surplus personal property identified as hazardous material not required for transfer as excess personal property to Federal agencies shall normally be made available for donation. However, State agencies shall not acquire hazardous materials without first ensuring that there are eligible known donees for such property. Surplus property identified as hazardous may be donated provided the donee:

(a) Is informed, via MSDS, HMIS data, or written narrative, that the item is hazardous and is furnished special handling and/or other appropriate information; and

(b) Signs the following certification:

I (We) hereby certify that the donee has knowledge and understanding of the hazardous nature of the property hereby donated and will comply with all applicable Federal, State, and local laws, ordinances, and regulations with respect to the care, handling, storage, shipment, and disposal of the hazardous material(s). The donee agrees

Federal Property Management Regulations

§ 101-42.401

and certifies that the Government shall not be liable for personal injuries to, disabilities of, or death of the donee or the donee's employees, or any other person arising from or incident to the donation of the hazardous material(s) or its final disposition. Additionally, the donee agrees and certifies to hold the Government harmless from any or all debts, liabilities, judgments, costs, demands, suits, actions, or claims of any nature arising from or incident to the donation of the hazardous material(s), its use, or final disposition.

§ 101-42.302 Responsibilities for donation of hazardous materials.

(a) *Holding agencies.* Holding agencies shall be responsible for the identification and reporting of hazardous materials as set forth in §§ 101-42.202 and 101-42.203. Pending transfer for donation, each holding agency shall be responsible for performing, and shall bear the cost of, care and handling of its hazardous materials.

(b) *State agencies.* State agencies or the donee when applicable, shall prepare Standard Form (SF) 123, Transfer Order Surplus Personal Property, under § 101-44.4901-123-1. A full description of the actual or potential hazard associated with handling, storage, or use of the item must be made available by providing an MSDS, HMIS data, or a narrative description in block 12c or included as an addendum to the SF 123. Such description shall comply with the requirements of 29 CFR 1910.1200. The State agency and/or donee shall sign the certification in § 101-42.301(b). Any applicable requirements and restrictions shall be forwarded with the SF 123 to the GSA regional office.

(c) *General Services Administration.* GSA, through its regional offices, shall be responsible for approving the transfer for donation of hazardous materials. Before approving any donation of a hazardous material, the GSA regional office shall make sure all required certifications and agreements accompany the SF 123.

§ 101-42.303 Hazardous materials distributed to donees by State agencies.

Donation of surplus personal property designated as hazardous material shall be accomplished by the use of State agency distribution document as set forth in § 101-44.208. In addition to

the terms, conditions, and restrictions in the distribution document, the donee shall certify to the conditions in § 101-42.301(b).

§ 101-42.304 Special requirements for donation of certain hazardous materials.

Special donation requirements for specific hazardous materials are provided in § 101-42.1102. Many hazardous materials require special storage and handling. It is the responsibility of the Federal holding agency or State agency to properly store hazardous materials, ensure the use of appropriate safeguards, and provide instructions for personal protection to donation screeners who are inspecting surplus hazardous materials. It is the responsibility of the State agency and/or donee to comply with DOT regulations (49 CFR part 171 *et seq.*) when transporting hazardous materials. Any costs incident to repacking or recontainerization will be borne by the State agency and/or donee. State agencies and/or donees will comply with EPA's Resource Conservation and Recovery Act (40 CFR part 261 *et seq.*) including its application to transporters, storers, users, and permitting of hazardous wastes. Such requirements may be administered by various States instead of the EPA.

Subpart 101-42.4—Sale, Abandonment, or Destruction of Surplus Hazardous Materials and Certain Categories of Property

§ 101-42.400 Scope of subpart.

This subpart prescribes the special policies and procedures governing the sale, abandonment, or destruction of hazardous materials and certain categories of property in addition to the requirements of part 101-45.

§ 101-42.401 Sales responsibilities for hazardous materials.

(a) *General Services Administration.* GSA, through its regional offices, shall be responsible for the sale of hazardous materials for holding agencies except for the Department of Defense, which is delegated authority to sell property under its control, and agencies granted approval by GSA. Holding agency sales

§ 101-42.402

of hazardous materials conducted in accordance with §101-45.304 must meet or exceed the requirements in §101-42.403.

(b) *Holding agencies.* Holding agencies shall be responsible for preparation of hazardous materials for sale as provided for in §101-45.103-2. Pending disposal, each holding agency shall be responsible for performing and bearing the cost of care and handling of its hazardous materials, including posting appropriate warning signs and rendering extremely hazardous property innocuous, or providing adequate safeguards.

§ 101-42.402 Reporting hazardous materials for sale.

Holding agencies shall report hazardous materials to be sold by GSA to the appropriate GSA regional office for the region in which the property is physically located in the manner outlined below:

(a) *Reportable property.* Hazardous materials are required to be reported to the GSA regional offices for utilization screening as set forth in subparts 101-42.2 through 101-42.4 and 101-42.11. If the hazardous materials are not transferred or donated, the hazardous materials will be programmed for sale by the GSA regional office without further documentation from the holding agency.

(b) *Nonreportable property.* Under §101-42.202, Federal holding agencies are required to identify and label hazardous materials. Hazardous materials not required to be reported for utilization screening, and for which any required donation screening has been completed, shall be reported to the appropriate GSA regional office on Standard Form (SF) 126, Report of Personal Property for Sale, as provided in §101-45.303.

(c) *Description and certification.* The SF 126 shall contain a certification, executed by a duly authorized agency official, in block 16c or as an addendum, that the item has been clearly labeled and packaged as required in §§101-42.202(e) and 101-42.204. The SF 126 shall also contain or be accompanied by a full description of the actual or potential hazard associated with handling, storage, or use of the item. Such de-

41 CFR Ch. 101 (7-1-01 Edition)

scription shall be furnished by providing:

- (1) An MSDS or copy thereof; or
- (2) A printed copy of the record, corresponding to the hazardous material being reported, from the automated HMIS; or
- (3) A written narrative, included in either block 16c or as an addendum, which complies with the requirements of 29 CFR 1910.1200.

§ 101-42.403 Sales methods and procedures.

Hazardous materials are sold in accordance with the provisions of §101-45.304 and the following special methods and procedures.

(a) Sales which offer hazardous materials shall be conducted separately from other sales. Sale catalogs or listings which offer hazardous materials shall not be mailed to all persons on the general sales mailing list but shall be sent to only those persons and entities which have expressed an interest in purchasing such materials.

(b) Sale catalogs, listings, and invitations for bids, with respect to hazardous materials, shall:

- (1) Limit the materials in each lot for sale to a single Federal supply group;
- (2) Indicate, in the item description, if an MSDS has been issued for the property being sold; and
- (3) Indicate, in the item description, if an item is being sold only for its material content.

(c) For a bid to be considered for award, the bidder must sign the following certification:

The bidder hereby certifies that if awarded a contract under this invitation for bids, the bidder will comply with all applicable Federal, State, and local laws, ordinances, and regulations with respect to the care, handling, storage, shipment, resale, export, or other use of the material hereby purchased. The bidder will hold the Government harmless from any or all debts, liabilities, judgments, costs, demands, suits, actions, or other claims of any nature arising from or incident to the handling, use, storage, shipment, resale, export, or other disposition of the hazardous items purchased.

(d) MSDSs, printed HMIS records, where applicable, or a written description in compliance with the requirements of 29 CFR 1910.1200 shall be sent

Federal Property Management Regulations

§ 101-42.1101

to purchasers of hazardous materials with their notice of award.

(e) Unless authorized by the appropriate GSA regional office, a holding agency shall not sell extremely hazardous property unless the property is rendered innocuous or adequate safeguards are provided. Such property shall be rendered innocuous in a manner so as to preserve the utility or commercial value of the property.

§ 101-42.404 Special requirements for the sale of hazardous materials.

Special sales requirements for certain hazardous materials are provided in § 101.42.1102. Hazardous items generally require special storage and handling. It is the responsibility of the holding agency to properly store hazardous items, to provide all necessary information to ensure that prospective bidders are informed of hazards, and to list the precautions bidders should take to protect themselves.

§ 101-42.405 Transportation of hazardous materials.

The transportation of hazardous materials is governed by the hazardous materials regulations (49 CFR parts 170-180) issued by the Department of Transportation. Except as otherwise provided below, an agency official, prior to the transportation of hazardous materials, shall certify on the shipping document, based on his/her own examination, that the materials are properly classified, described, packaged, marked, and labeled and are in proper condition for transportation in accordance with the hazardous materials regulations. The shipper shall provide such certification in duplicate and give one copy to the originating carrier and retain the other for no less than 1 year. Hazardous materials sold by the Department of Defense (DOD) in packings not marked under the hazardous materials regulations may be shipped from DOD installations, provided DOD certifies in writing on a certificate or equivalency (COE) that the packing meets or exceeds requirements of the hazardous materials regulations.

§ 101-42.406 Abandonment or destruction of surplus hazardous materials and certain categories of property.

In addition to the requirements for the abandonment or destruction of surplus property prescribed in subpart 101-45.9, hazardous materials, including empty hazardous material containers, shall be abandoned or destroyed under Federal, State, and local waste disposal and air and water pollution control standards. Additional requirements for the abandonment and destruction of certain specific hazardous materials are contained in § 101-42.1102.

Subparts 101-42.5—101-42.10 [Reserved]

Subpart 101-42.11—Special Types of Hazardous Materials and Certain Categories of Property

§ 101-42.1100 Scope of subpart.

This subpart prescribes disposal procedures for certain hazardous items and lists specific Federal supply classes which may contain hazardous items.

§ 101-42.1101 Federal supply classification (FSC) groups and classes which contain hazardous materials.

(a) Hazardous material identification is required for all material which, by virtue of its potentially dangerous nature, requires controls to assure adequate safety to life, property, and the environment, and which is therefore defined as a hazardous material.

(b) The tables in paragraph (c) of this section list those FSC classes composed predominantly of hazardous materials and those FSC classes which contain a significant number of hazardous materials. Those classes that contain munitions list items (MLI) which require demilitarization are not identified in the tables because the items in those classes must be identified by the appropriate demilitarization code and processed under the procedures in § 101-42.1102-8.

(c) The tables as listed in Federal standard 313 are as follows:

§ 101-42.1101

41 CFR Ch. 101 (7-1-01 Edition)

FEDERAL SUPPLY CLASSES COMPOSED
PREDOMINANTLY OF HAZARDOUS ITEMS

Federal Supply Class (FSC)

- 6810 Chemicals
- 6820 Dyes
- 6830 Gases: Compressed and liquified
- 6840 Pest control agents and disinfectants
- 6850 Miscellaneous chemical specialties
- 7930 Cleaning and polishing compounds and preparations
- 8010 Paints, dopes, varnishes, and related products
- 8030 Preservative and sealing compounds
- 8040 Adhesives
- 9110 Fuels, solid

- 9130 Liquid propellants and fuels, petroleum case
- 9135 Liquid propellant fuels and oxidizers, chemical base
- 9140 Fuel oils
- 9150 Oils and greases: Cutting, lubricating, and hydraulic
- 9160 Miscellaneous waxes, oils, and fats

FEDERAL SUPPLY CLASSES AND GROUPS WHICH
CONTAIN A SIGNIFICANT NUMBER OF HAZARDOUS ITEMS

NOTE: If an item is determined to be hazardous as defined in §101-42.001, a material safety data sheet (or equivalent) should accompany the item even though the Federal supply class is not listed in this table.

Federal supply class/grp	Title	Examples of hazardous materials requiring identification
1370	Pyrotechnics	Warning fuse, fire starter.
1375	Demolition materials	Explosive device.
2520	Vehicular power transmission components ...	Items containing asbestos.
2530	Vehicular brake steering, axle, wheel, and track components.	Items containing asbestos.
2540	Vehicular furniture and accessories	Items containing asbestos.
2640	Tire rebuilding and tire and tube repair materials.	Items containing flammable or toxic compounds.
Group 28 ..	Engines, turbines, and components	Engine valves containing metallic sodium.
Group 29 ..	Engine accessories	Engine valves containing metallic sodium.
Group 30 ..	Mechanical power transmission equipment ...	Equipment containing hazardous hydraulic fluids including PCBs.
Group 34 ..	Metalworking machinery	Equipment containing hazardous hydraulic fluids including PCBs.
3433	Gas welding, heat cutting, and metalizing equipment.	Compressed gases.
3439	Miscellaneous welding, soldering and brazing supplies and accessories.	Hazardous items such as cleaners, acids, flux and supplies that contain or produce hazardous fumes.
3610	Printing, duplicating, and bookbinding equipment.	Flammable or toxic lithographic solutions.
3655	Gas generating and dispensing systems, fixed or mobile.	Items that produce hazardous fumes.
3680	Foundry machinery, related equipment and supplies.	Flammable or toxic casting compounds.
4240	Safety and rescue equipment	Items which involve oxygen, or compressed gases, or contain emitting charges.
5610	Mineral construction materials, bulk	Hazardous items such as cutback asphalt, deck and floor covering, deck and surface underlay compound, sealing compound, flight deck compound.
5660	Wallboard, building paper, and thermal insulation materials.	Asbestos cloth which has loose fibers or particles that may become airborne and materials containing formaldehyde.
5820	Radio and television communication equipment, except airborne.	Circuit cooler items that contain gases that are regarded as hazardous to the earth's ozone layer.
5835	Sound recording and reproducing equipment	Recording tape cleaners that contain hazardous cleaning fluids.
5910	Capacitors	Items that contain polychlorinated biphenyls (PCBs) or sulfuric acid.
5915	Filters and networks	Items that contain polychlorinated biphenyls (PCBs).
5920	Fuses and lightning arresters	Items that contain radioactive material.
5925	Circuit breakers	Items that contain radioactive material.
5930	Switches	Items containing radioactive materials.
5935	Connectors, electrical	Kits that contain flammable chemicals.
5950	Coils and transformers	Items containing polychlorinated biphenyls (PCBs).
5960	Electron tubes and associated hardware	Tubes which contain radioactive isotopes and require warning labels and megnetron tubes which require special precautions when being prepared for air shipment.
5965	Headsets, handsets, microphones, and speakers.	Items containing magnetic material.
5970	Electrical insulators and insulating materials	Items containing flammable solvents.
5975	Electrical hardware and supplies	Items containing asbestos.
5985	Antennas, waveguide, and related equipment	Kits that contain flammable chemicals.
5999	Miscellaneous electrical and oxide electronic components.	Contact plates that contain beryllium.
Group 61 ..	Electric wire and power and distribution equipment.	Power factor capacitors containing PCBs.
6120	Transformers: Distribution and power station	Transformers containing PCBs.

Federal Property Management Regulations

§ 101-42.1102-1

Federal supply class/grp	Title	Examples of hazardous materials requiring identification
6135	Batteries, primary	Lead-acid, lithium and mercury batteries and alkaline (with electrolyte).
6140	Batteries, secondary	Items that are wet or moist containing corrosive or other hazardous compounds.
6145	Wire and cable, electrical	Insulated wire containing asbestos.
6220	Electric vehicular lights and fixtures	Items that contain mercury.
6230	Electric portable and hand lighting equipment	Items that contain wet batteries.
6240	Electric lamps	Items that contain mercury.
6260	Nonelectrical lighting fixtures	Items that contain mercury.
6350	Miscellaneous signal and security detection systems.	Items that contain wet batteries or radioactive material.
6505	Drugs, biologicals and official reagents	Hazardous items as defined in §101-42.001.
6508	Medicated cosmetics and toiletries	Hazardous items as defined in § 101-42.001 subject to DOT Hazardous Materials Regulations.
6510	Surgical dressing materials	Items containing flammable solvents.
6520	Dental instruments, equipment, and supplies	Items containing flammable solvents, mercury, or asbestos.
6525	X-ray equipment and supplies: medical, dental, veterinary.	Items containing hazardous chemicals, solvents.
6625	Electrical and electronic properties measuring and testing instruments.	Items containing radioactive materials.
6640	Laboratory equipment and supplies	Items containing flammable compounds, mercury, or asbestos.
6685	Pressure, temperature, and humidity and measuring and controlling instruments.	Items containing mercury or compressed gases.
6740	Photographic	Items containing radioactive compounds.
6750	Photographic supplies	Items containing hazardous chemicals, solvents, thinners, and cements.
6780	Photographic sets, kits and outfits	Items containing hazardous chemicals, solvents, thinners, and cements.
7360	Sets, kits, and outfits; food preparation and serving.	Items containing compressed gases such as fire extinguishers.
7510	Office supplies	Hazardous items, such as thinners, cleaning fluids, flammable inks, and varnishes.
8405	Outerwear, men's	Maintenance kits containing flammable solvents.
8410	Outerwear, women's	Maintenance kits containing flammable solvents.
8415	Clothing, special purpose	Maintenance kits containing flammable solvents.
8465	Individual equipment	Maintenance kits containing flammable solvents.
8510	Perfumes, toilet preparations, and powders ..	Shipping containers, and pressurized containers with flammable or nonflammable propellants.
8520	Toilet soap, shaving preparations, and dentifrices.	Shipping containers, pressurized containers with flammable or nonflammable propellants.
8720	Fertilizers	Items containing weed and pest control or other harmful ingredients or because of their composition, are hazardous.
9390	Miscellaneous fabricated nonmetallic materials.	Items containing flammable solvents or asbestos.
9920	Smokers' articles and matches	Lighter fuel and matches only.
9930	Memorials; cemetery and mortuary equipment and supplies.	Items containing formaldehyde or its solutions.

§ 101-42.1102 Special requirements for utilization, donation, sale, and abandonment or destruction of hazardous materials and certain categories of property.

§ 101-42.1102-1 Asbestos.

(a) *General.* (1) Asbestos is the common name for a group of natural minerals that occur as masses of compact or relatively long silky fibers. The Environmental Protection Agency classified asbestos as a hazardous air pollutant in 1972.

(2) Friable asbestos materials contain more than one percent asbestos by weight and can, by hand pressure, be

crumbled, pulverized, or reduced to powder, thus allowing for potential release of asbestos fibers into the air.

(3) Nonfriable asbestos materials cannot, when dry, be crumbled, pulverized, or reduced to powder by hand pressure and contain asbestos which is bonded or otherwise rendered unavailable for release into the atmosphere through normal usage. However, cutting, sanding, crushing, or performing some other disruptive action on items containing nonfriable asbestos can release asbestos fibers into the air.

(4) As noted in this §101-42.1102-1, property containing friable asbestos

normally shall not be transferred, donated, or sold. Notwithstanding these provisions, holding agencies may, on a case-by-case basis, request approval from the GSA Central Office (which will consult with EPA) to transfer, donate, or sell such property if, in the judgement of the holding agency, special circumstances warrant such action.

(b) *Utilization requirements.* (1) Excess personal property known to contain friable asbestos shall not be reported to GSA nor transferred among Federal agencies except as noted in §101-42.205(c) or paragraph (a)(4) of this section. GSA regional offices shall return any reports of excess property containing friable asbestos to the holding agency with instructions to dispose of the property under paragraph (e) of this section.

(2) Excess personal property containing nonfriable asbestos shall be reported and processed in the normal manner, as provided for in part 101-43, except that:

(i) The Standard Form (SF) 120, Report of Excess Personal Property, and SF 122, Transfer Order, Excess Personal Property, and any other appropriate documentation shall include the following warning:

WARNING

This property contains asbestos. Inhaling asbestos fibers may cause cancer. Do not release fibers by cutting, crushing, sanding, disassembling, or otherwise altering this property. End users and new owners, if transferred, should be warned. OSHA standards for personnel protection are codified at 29 CFR 1910.1001. EPA disposal standards are codified at 40 CFR part 763.

(ii) Immediately after excess determination, all items of personal property known to contain nonfriable asbestos shall be labeled with a warning substantially as follows:

WARNING

This property contains asbestos. Inhaling asbestos fibers may cause cancer. Do not release fibers by cutting, crushing, sanding, disassembling, or otherwise altering this property.

(c) *Donation requirements.* (1) Surplus personal property containing friable asbestos shall not be donated. Such

property shall be disposed of under paragraph (e) of this section.

(2) Surplus personal property containing nonfriable asbestos may be donated in the normal manner as provided for in part 101-44, except that:

(i) The Standard Form (SF) 123, Transfer Order Surplus Personal Property, and any other appropriate documentation shall include the warning as provided by paragraph (b)(2)(i) of this section.

(ii) All items of personal property to be donated which contain nonfriable asbestos shall be labeled as provided by paragraph (b)(2)(ii) of this section.

(d) *Sales requirements.* (1) Surplus personal property containing friable asbestos shall not be sold. Such property shall be disposed of under paragraph (e) of this section.

(2) Surplus personal property containing nonfriable asbestos may be sold as provided for in part 101-45, except that:

(i) Any documentation which lists the property to be sold and which is prepared incident to the sale, and any printed matter which advertises the sale of personal property containing nonfriable asbestos shall include the warning as provided by paragraph (b)(2)(i) of this section.

(ii) All items of personal property to be sold which contain nonfriable asbestos shall be labeled as provided by paragraph (b)(2)(ii) of this section.

(e) *Abandonment and destruction.* (1) Excess or surplus personal property which contains friable asbestos shall be disposed of by burial in a site which meets the requirements of 40 CFR 61.156. Holding agencies should contact the nearest office of the Environmental Protection Agency for assistance with regard to disposal of asbestos containing materials (with the exception of Department of Defense activities which should contact the Defense Logistics Agency).

(2) Personal property containing nonfriable asbestos which is not transferred, donated, or sold shall be abandoned or destroyed as provided for in subpart 101-45.9. However, if the holding agency judges that the nonfriable asbestos contained in the property has the potential of becoming friable for

Federal Property Management Regulations

§ 101-42.1102-2

any reason during the process of abandonment or destruction, such property shall be disposed of as provided in paragraph (e)(1) of this section.

§ 101-42.1102-2 Polychlorinated biphenyls.

(a) *General.* (1) Polychlorinated biphenyls (PCBs) are one member of a class of chlorinated aromatic compounds which have been determined to be hazardous to health and the environment. They are used, among other things, as insulators and coolants for electric cables and components such as transformers and capacitors, as additives for extreme pressure lubricants, and as coatings in foundry use.

(2) Substances containing PCBs are divided into three classes according to the concentration of PCBs present, as measured by parts per million (ppm).

(i) Zero through 49 ppm is classified as an *excluded PCB product*.

(ii) Fifty through 499 ppm PCB is classified as *PCB item*.

(iii) Five hundred or greater ppm PCB is classified as *PCB*.

(3) Excluded PCB products (0-49 ppm PCB) are not subject to Federal restrictions and may be transferred, donated, sold, or otherwise processed under parts 101-43 through 101-46 of this chapter provided such processing conforms to the provisions of this section and all applicable State and local laws. Some States regulate PCB concentrations at a stricter level than does the Federal Government.

(4) All PCBs and PCB items to be transferred, donated, or sold shall be labeled or marked conspicuously with a warning substantially as follows:

Caution—This item contains PCBs (polychlorinated biphenyls), a toxic environmental contaminant requiring special handling and disposal in accordance with the U.S. Environmental Protection Agency regulation (40 CFR 761), applicable State laws, and 41 CFR 101-42.1102-2. For proper disposal information, contact the nearest EPA office. For transportation requirements, see 49 CFR Parts 171-180.

(5) Unmarked or unlabeled items containing PCBs or PCB items with an unknown level of concentration of PCBs shall not be transferred, donated, or sold.

(b) *Utilization requirements.* (1) PCBs and PCB items are reported for utilization screening in accordance with § 101-42.204.

(2) Transfers of excess PCBs or PCB items shall not be approved by GSA unless:

(i) The items are intact, non-leaking, and totally enclosed.

(ii) The SF 122, Transfer Order Excess Personal Property, or other transfer document cites the specific provision in 40 CFR Part 761 that permits continued use of the item, and contains a certification that the property has been inspected by the transferee and complies with all the use, inspection, labeling, and other provisions of 40 CFR part 761.

(3) When a PCB or PCB item is transferred as excess to another agency, the receiving agency shall annotate its property accountability records to reflect the nature and extent of the PCB content and shall list the provisions of 40 CFR part 761 authorizing use of the item. If tests are conducted to ascertain the nature and extent of PCB contamination, the receiving agency shall furnish the GSA regional office with a copy of the test results. Such information shall be perpetuated on any notification or release documents when the agency disposes of the property.

(c) *Donation requirements.* (1) No PCB or PCB-contaminated items shall be approved by GSA for donation under part 101-44 unless:

(i) The certification required by § 101-42.1102(a)(4) appears on the SF 123, Transfer Order Surplus Personal Property;

(ii) The specific donee has been determined; and

(iii) A justification from the recipient is attached stating the proposed use of the property and citing the specific provision in 40 CFR part 761 that permits continued use of the item.

(2) All PCBs and PCB items must be in usable condition and in working order to be eligible for donation. Such items that are not in usable condition will not be approved for donation.

(3) Items to be donated must be intact, totally enclosed, and non-leaking.

(4) If PCBs or PCB items are donated to service educational activities or to

public airports, the Department of Defense or the Federal Aviation Administration, respectively, shall obtain the following signed warning and certification from the donee. State agencies for surplus property shall have the warning and certification typed or stamped on the face of each copy of the distribution document and signed and dated by the authorized representative of the donee organization at the time the property is issued.

Warning and certification:

The donee is aware that the item(s) listed as containing polychlorinated biphenyls (PCBs), a toxic environmental contaminant, require(s) special handling and disposal in accordance with U.S. Environmental Protection Agency regulation (40 CFR part 761) and U.S. Department of Transportation regulations codified in 49 CFR parts 171-180. The donee certifies that this item will be handled and disposed of in accordance with applicable Federal statutes and regulations and applicable State laws.

(d) *Sales requirements.* (1) Surplus PCBs or PCB items normally shall not be sold by GSA or holding agencies. These items are regarded as extremely hazardous and are to be disposed of by the holding agency under the Environmental Protection Agency regulations.

(2) Agencies may request the authority to sell, or that GSA sell, a specific PCB or PCB item. Such requests shall cite the provision in 40 CFR part 761 that authorizes sale and continued use of the specific item. Any such requests shall also include a justification for sale of the item rather than disposal under the EPA regulations.

(3) If PCBs or PCB items are to be sold, the corresponding invitation for bids (IFB), any Standard Form (SF) which lists such items, and any printed matter which advertises the sale of such items shall contain the warning as provided in paragraph (a)(4) of this section.

(e) *Abandonment and destruction.* (1) PCBs and PCB items of personal property not disposed of via utilization, donation, or sale shall be destroyed or otherwise disposed of in accordance with the Environmental Protection Agency regulation (40 CFR part 761) and applicable State laws.

(2) Holding agencies shall contact the nearest office of the EPA for assistance

in complying with the provisions of 40 CFR part 761.

§ 101-42.1102-3 Controlled substances.

(a) *Utilization requirements.* (1) Excess controlled substances are not required to be reported to GSA, but are subject to the utilization screening requirements of § 101-43.311-2. Holding agencies shall make reasonable efforts to obtain utilization of excess controlled substances by offering them to those Federal agencies which certify that they are registered with the Drug Enforcement Administration (DEA), Department of Justice, and are authorized to procure the particular controlled substances requested for transfer. The certification shall include the registration number on the DEA Form 223, Certificate of Registration, issued by DEA.

(2) Holding agencies shall arrange for transfers of controlled substances under §§ 101-43.309-5 and 101-42.207.

(3) All controlled substances that a holding agency determines to be excess shall become surplus after the holding agency has complied with the utilization requirements of paragraph (a)(1) of this section.

(b) *Donation requirements.* Controlled substances shall not be donated.

(c) *Sales requirements.* Surplus controlled substances which are not required to be destroyed as provided in paragraph (d) of this section may be offered for sale by sealed bid under subpart 101-45.3 provided:

(1) The invitation for bids (IFB):

(i) Consists only of surplus controlled substances;

(ii) Requires the normal bid deposit prescribed in § 101-45.304-10;

(iii) Is distributed only to bidders who are registered with the DEA, Department of Justice, to manufacture, distribute, or dispense the controlled substances for which the bid is being submitted; and

(iv) Contains the following special condition of sale:

The bidder shall complete, sign, and return with his/her bid the certificate as contained in this invitation. No award will be made or sale consummated until after this agency has obtained from the Drug Enforcement Administration, Department of Justice, verification that the bidder is registered to manufacture, distribute, or dispense those

Federal Property Management Regulations

§ 101-42.1102-5

controlled substances which are the subject of the award.

(2) The following certification shall be made a part of the IFB (and contract) to be completed and signed by the bidder and returned with the bid:

The bidder certifies that he/she is registered with the Drug Enforcement Administration, Department of Justice, as a manufacturer, distributor, or dispenser of the controlled substances for which a bid is submitted and that the registration number is _____.

Name of bidder (print or type)

Signature of bidder

Address of bidder (print or type)

City, State, Zip code

(3) As a condition precedent to making an award for surplus controlled substances, the following shall be submitted to the Drug Enforcement Administration (DEA), Department of Justice, Washington, DC 20537, Attn: Regulatory Support Section (ODR):

(i) The name and address of the bidder(s) to whom an award is proposed to be made and the bidder(s) registration number(s);

(ii) The name and address of both the holding activity and the selling activity;

(iii) A description of the controlled substances, how those substances are packaged, and the quantity of substances proposed to be sold to the bidder;

(iv) The identification of the IFB by its number, and date on which such bid(s) expire(s); and

(v) A request for advice as to whether the bidder is a registered manufacturer, distributor, or dispenser of controlled substances.

(d) *Destruction of controlled substances.* Controlled substances shall not be abandoned, and destruction of controlled substances must be accomplished in accordance with the terms and conditions applicable to drugs, biologicals, and reagents under §101-42.1102-5(d).

(1) The following shall be destroyed by the holding agency or State agency:

(i) Controlled substances determined surplus at one time and one place with an acquisition cost of less than \$500;

(ii) Controlled substances in a deteriorated condition or otherwise unusable;

(iii) Controlled substances for sale in accordance with §101-42.1102-3(c) but for which no satisfactory or acceptable bids were received.

(2) In addition to the requirements set forth herein, each executive agency and State agency shall comply with the DEA regulations, 21 CFR 1307.21, which provide procedures for disposing of controlled substances, or with equivalent procedures approved by DEA.

(3) Destruction of controlled substances shall be performed by an employee of the holding agency or State agency in the presence of two additional employees of the agency as witnesses to that destruction unless the special agent in charge (SAC) of the DEA Divisional Office directs otherwise.

§ 101-42.1102-4 Nuclear Regulatory Commission-controlled materials.

(a) *General.* The Nuclear Regulatory Commission (NRC) has exclusive control over licensing, use, transfer, and disposition of NRC-controlled materials.

(b) *Transfer of NRC-controlled materials.* NRC-controlled materials shall not be reported to GSA as excess personal property, nor shall they be made available for excess and surplus screening as nonreportable property. Transfer and disposition of such materials do not require GSA approval and shall be accomplished only under the applicable regulations of the NRC (see 10 CFR parts 30 through 35, 40, and 70).

(c) *Information and inquiries.* All inquiries for further information or specific instructions regarding the licensing, use, transfer, or disposition of NRC-controlled materials shall be directed to the U.S. Nuclear Regulatory Commission, Washington, DC 20555.

§ 101-42.1102-5 Drugs, biologicals, and reagents other than controlled substances.

In addition to the requirements of subparts 101-42.2 through 101-42.4, drugs, biologicals, and reagents which are fit for human use shall be reported as provided in this §101-42.1102-5. Drugs, biologicals, and reagents that

are controlled substances are subject to the provisions of §101-42.1102-3.

(a) *Utilization requirements.* Excess drugs, biologicals, and reagents shall be reported or otherwise made available to GSA as provided in §101-42.204 and subpart 101-43.3. Drugs, biologicals, and reagents other than controlled substances may be separately packaged or may be components of a drug kit. Drug kits shall be clearly labeled to identify components unfit for human use. The holding agency shall destroy, as provided in paragraph (d) of this section, both separately packaged items and kit components which have been determined by the holding agency to be unfit for human use. However, items determined unfit because of expired shelf life may be transferred for animal experimental use on a case-by-case basis subject to prior approval by GSA.

(b) *Donation requirements.* Surplus drugs, biologicals, and reagents other than controlled substances which are not required to be destroyed as provided in paragraph (d) and which are not transferred pursuant to paragraph (a) of this section may be donated to eligible organizations as provided in subpart 101-42.3 and part 101-44. Drugs, biologicals, and reagents which are unfit for human use will not be offered for donation. However, items determined unfit because of expired shelf life may be donated for animal experimental use on a case-by-case basis subject to prior approval by GSA.

(1) When surplus drugs, biologicals, and reagents are considered for donation, a letter of clearance shall be obtained by the State agency or designated donee from the Food and Drug Administration (FDA) indicating that the items requested may be safely donated. The letter of clearance must accompany the SF 123. Items which do not fall within the purview of FDA, or which FDA indicates are unsuitable, will not be considered by GSA for donation.

(2) For purposes of obtaining the letter of clearance from FDA, the State agency or designated donee shall be responsible for obtaining samples from the holding agency, providing these samples to FDA, and ensuring the security of the samples while in transit. Before laboratory examinations are un-

dertaken by FDA, an estimate of the expected cost of the quality assurance examination shall be furnished by FDA to the State agency or donee. Payment of any costs for laboratory examinations for quality assurance of samples shall be arranged by the State agency or donee.

(3) Surplus drugs, biologicals, and reagents requested for donation by State agencies shall not be transported by the State agency or stored in its warehouse prior to distribution to donees. Arrangements will be made by the State agency for the donee to make direct pickup at the holding agency after approval by GSA and after notification by the holding agency that the property is ready for pickup.

(4) Standard Forms 123 from a State agency requesting surplus drugs, biologicals, and reagents for donation shall not be processed or approved by GSA until it has been determined by the GSA donation representative that the specific donee is legally licensed to administer, dispense, store, or distribute such property.

(5) The SF 123 shall also contain a statement that:

(i) The property is being requested for donation to a specific donee whose complete name and address, including the name and telephone number of the donee's authorized representative, appear on the front of the SF 123 in block 12, and that a copy of the donee's license, registration, or other legal authorization to administer, dispense, store, or distribute such property is attached and made a part of the SF 123;

(ii) The items will be distributed only to institutions licensed and authorized to administer and dispense such items or to organizations authorized to store such items; and

(iii) In addition to the normal certifications required to be executed by authorized representatives of donee institutions or organizations when property is acquired by donation, the State agency shall obtain a certification from the donee indicating that:

(A) The items transferred to the donee institution or organization will be safeguarded, dispensed, and administered under competent supervision;

(B) Adequate facilities are available to effect full accountability and proper

Federal Property Management Regulations

§ 101-42.1102-5

storage of the items under the Federal, State, and local statutes governing their acquisition, storage, and accountability;

(C) The administration or use of the items requested shall be in compliance with the Federal Food, Drug, and Cosmetic Act, as amended (21 U.S.C. 301-394).

(c) *Sales requirements.* Surplus drugs, biologicals, and reagents other than controlled substances which are not required to be destroyed as provided in paragraph (d) and which are not transferred pursuant to paragraph (a) or (b) of this section may be offered for sale by sealed bid under the provisions of subparts 101-45.3 and 101-42.4. The following safeguards and instructions shall be observed to ensure stability, potency, and suitability of the product and its labeling for use in civilian channels:

(1) Before reporting the surplus drugs, biologicals, and reagents to the selling agency pursuant to the provisions of §§101-45.303 and 101-42.402, holding agencies shall request that an examination be made by the Field Scientific Coordination Staff, ACFA-CF-30, located in the appropriate FDA district office, of surplus unexpired drugs and reagents, having an acquisition cost of \$500 or more per manufacturer's lot/batch number.

(i) When requesting such an examination, FDA requires the submission of a list and one sample of each of the drugs to be examined.

(ii) Additional samples may be requested if necessary for laboratory examination. Reimbursement for examination of the surplus drugs or reagents may be required by FDA. Before laboratory examinations are undertaken, FDA will give the inquiring agency an estimate of the expected costs. If, under subpart 101-45.9, the cost of the quality assurance is not justified by the value of the material involved, the lot or lots may be destroyed.

(iii) The reporting document prescribed in §101-45.303(b) shall have attached to it a copy of the letter received by the reporting agency from FDA stating that the articles offered have been reviewed and may appropriately be distributed or sold, subject

when necessary to specified limitations.

(2) Surplus drugs, biologicals, and reagents normally shall not be physically transferred to the selling agency but should remain at the holding agency for precautionary and safety measures.

(3) Surplus drugs, biologicals, and reagents shall be sold only to those entities which are legally qualified to engage in the sale, manufacture, or distribution of such items.

(4) Sales of surplus drugs, biologicals, and reagents other than controlled substances shall be processed as follows:

(i) The invitation for bids (IFB) shall:

(A) Consist only of surplus drugs, biologicals, and reagents;

(B) Contain the expiration date of material being offered for sale;

(C) Describe the composition of the material being offered for sale;

(D) Require the normal bid deposit prescribed in §101-45.304-10; and

(E) Contain the following special condition of sale:

The bidder shall complete, sign, and return with his/her bid the certification as contained in this invitation. No award will be made or sale consummated until after this agency has determined that the bidder is legally licensed to engage in the manufacture, sale, or distribution of drugs.

(ii) The following certification shall be made a part of the invitation for bids (and contract), to be completed and signed by the bidder, and returned with the bid with a copy of his/her license. Failure to sign the certification may result in the bid being rejected as nonresponsive.

The bidder certifies that he/she is legally licensed to engage in the manufacture, sale, or distribution of drugs, and proof of his/her license to deal in such materials is furnished with this bid.

Name of bidder (print or type)

Signature of bidder

Address of bidder (print or type)

City, State, ZIP code

(d) *Destruction of surplus drugs, biologicals, and reagents.* (1) Surplus drugs, biologicals, and reagents shall

§ 101-42.1102-6

41 CFR Ch. 101 (7-1-01 Edition)

not be abandoned under any circumstances. The following shall be destroyed by the holding agency under the provisions of this paragraph (d):

(i) Surplus drugs, biologicals, and reagents determined by the holding agency to be unsafe because of deterioration or overage condition, in open or broken containers, recommended for destruction by FDA, unfit for human consumption, or otherwise unusable; and

(ii) Surplus drugs, biologicals, and reagents which have been offered for sale under the provisions of paragraph (c) of this section but for which no satisfactory or acceptable bid or bids have been received.

(2) When surplus drugs, biologicals, and reagents are required to be destroyed by the holding agency or State agency, they shall be destroyed in such a manner as to ensure total destruction of the substance to preclude the use of any portion thereof. When major amounts are to be destroyed, the action shall be coordinated with local air and water pollution control authorities.

(3) Destruction of surplus drugs, biologicals, and reagents shall be performed by an employee of the holding agency or State agency in the presence of two additional employees of the agency as witnesses to that destruction.

(i) Disposal of Resource Conservation and Recovery Act (RCRA) regulated, noncontrolled, condemned hazardous substances in Federal supply class (FSC) 6505 shall be destroyed without the witnessing by two employees of the agency. The controls which the Environmental Protection Agency places upon the disposal of RCRA regulated noncontrolled drugs, 40 CFR part 260 *et seq.*, are sufficiently stringent to ensure that these drugs will be destroyed without agency witnessing.

(ii) It is the holding agency's responsibility to take all necessary measures to ensure that contractor performance is in accordance with the provisions of this §101-42.1102-5.

(4) When surplus drugs, biologicals, and reagents have been destroyed, the fact, manner, and date of the destruction and type and quantity destroyed shall be so certified by the agency em-

ployee charged with the responsibility for that destruction. The two agency employees who witnessed the destruction shall sign the following statement, except as noted in paragraph (d)(3) of this section, which shall appear on the certification below the signature of the certifying employee:

I have witnessed the destruction of the (drugs, biologicals, and reagents) described in the foregoing certification in the manner and on the date stated herein:

Witness _____ Date _____

Witness _____ Date _____

(5) Items mentioned parenthetically in the statement contained in paragraph (d)(5) of this section which are not applicable at the time of destruction shall be deleted from the statement. The signed certification and statement of destruction shall be made a matter of record and shall be retained in the case files of the holding agency or State agency.

§ 101-42.1102-6 Noncertified and certified electronic products.

(a) Utilization requirements.(1) Excess electronic items for which radiation safety performance standards are prescribed by FDA under 21 CFR Part 1000 shall be reported or otherwise made available for transfer to Federal agencies under subparts 101-43.3 and 101-42.2. Excess reports shall identify noncertified electronic products and shall contain a statement that the items may not be in compliance with applicable radiation safety performance standards prescribed by FDA under 21 CFR Part 1000. Certified electronic products may be reported and transferred under the procedures in part 101-43.

(2) Transfers of noncertified electronic products among Federal agencies shall be accomplished as set forth in §§101-42.207, 101-43.309, and paragraph (a) of this section. The transfer order must contain a certification that the transferee is aware of the potential danger in using the item without a radiation test to determine the acceptability for use and/or modification to bring it into compliance with the radiation safety performance standard prescribed for the item under 21 CFR Part 1000 and agrees to accept the item from

Federal Property Management Regulations

§ 101-42.1102-6

the holding agency under these conditions.

(b) *Donation requirements.* (1) Surplus noncertified and certified electronic products not required for transfer as excess personal property to Federal agencies under paragraph (a) of this section shall be made available for donation screening as provided in subpart 101-42.3 and part 101-44 and as follows:

(i) Under paragraph (b)(2) of this section in the case of:

(A) Noncertified color television receivers;

(B) Certified and noncertified diagnostic X-ray systems and their major components;

(C) Certified and noncertified cabinet X-ray systems;

(D) Noncertified laser products; or

(E) Any other electronic products subject to an FDA performance standard.

(ii) Only under conditions of destructive salvage in the case of noncertified cold-cathode gas discharge tubes, noncertified black and white television receivers, and noncertified microwave ovens.

(2) Donation of electronic products designated in paragraph (b)(1)(i) of this section shall be accomplished as provided in §101-44.109 provided the State agency, Department of Defense (DOD), or Federal Aviation Administration (FAA):

(i) Provides the applicable State radiation control agency (see §101-45.4809) with a copy of the SF 123 and the name and address of the donee; and

(ii) Requires the donee to certify on the SF 123 that it:

(A) Is aware of the potential danger in using the product without a radiation test to determine the acceptability for use and/or modification to bring it into compliance with the radiation safety performance standard prescribed for the item under 21 CFR part 1000, and agrees to accept the item from the holding agency for donation under those conditions;

(B) Agrees the Government shall not be liable for personal injuries to, disabilities of, or death of the donee or the donee's employees, or any other person arising from or incident to the donation of the item, its use, or its final disposition; and

(C) Agrees to hold the Government harmless from any or all debts, liabilities, judgments, costs, demands, suits, actions, or claims of any nature arising from or incident to the donation of the item, its use, or its final disposition.

(c) *Sales requirements.* (1) The sale of the following certified and noncertified surplus electronic products which are not required for transfer or donation shall be accomplished under §101-45.304, subpart 101-42.4, and the special conditions of sale in this paragraph (c).

(i) Noncertified color and black and white television receivers;

(ii) Noncertified microwave ovens;

(iii) Noncertified and certified diagnostic X-ray systems and their major components;

(iv) Noncertified and certified cabinet X-ray systems;

(v) Noncertified laser products;

(vi) Noncertified cold-cathode gas discharge tubes under conditions of scrap or destructive salvage; and

(vii) Any other noncertified electronic product for which FDA may promulgate a performance standard.

(2) The IFB shall contain a notice to bidders substantially as follows:

Purchasers are warned that the item purchased herewith may not be in compliance with Food and Drug Administration radiation safety performance standards prescribed under 21 CFR part 1000, and use may constitute a potential for personal injury unless modified. The purchaser agrees that the Government shall not be liable for personal injuries to, disabilities of, or death of the purchaser, the purchaser's employees, or to any other persons arising from or incident to the purchase of this item, its use, or disposition. The purchaser shall hold the Government harmless from any or all debts, liabilities, judgments, costs, demands, suits, actions, or claims of any nature arising from or incident to purchase or resale of this item. The purchaser agrees to notify any subsequent purchaser of this property of the potential for personal injury in using this item without a radiation survey to determine the acceptability for use and/or modification to bring it into compliance with the radiation safety performance standard prescribed for the item under 21 CFR part 1000.

(3) Within 30 calendar days following award, the selling agency shall provide the State radiation control agency for the State in which the buyer is located (see §101-45.4809) with a written notice of the award that includes the name

§ 101-42.1102-7

41 CFR Ch. 101 (7-1-01 Edition)

and address of the purchaser and the description of the item sold.

(d) *Abandonment or destruction.* Non-certified and certified electronic products shall be abandoned under the provisions of subpart 101-45.9 and § 101-42.406.

§ 101-42.1102-7 Lead-containing paint and items bearing lead-containing paint.

(a) *General*—(1) *Health hazard.* Lead is a cumulative toxic heavy metal which, in humans, exerts its effects on the renal, hematopoietic, and nervous systems. Lead poisoning occurs most commonly when lead-containing paint chips in the environment are chewed or ingested by children or when lead-containing paint is burned off.

(2) *Banned hazardous products.* The following consumer products, in accordance with 16 CFR part 1303 and exemptions stated therein unless exempted by 16 CFR part 1303, are banned hazardous products:

(i) Paint and other similar surface coating materials for consumer use which are included within the definition of lead-containing paint.

(ii) Toys and other articles intended for use by children that bear lead-containing paint.

(iii) Furniture articles that bear lead-containing paint.

(3) *Disposal of banned hazardous products.* When a banned hazardous product described in paragraph (a)(2) of this section becomes excess to a holding agency, it shall be destroyed under paragraph (e) of this section except that those furniture articles that bear lead-containing paint may be stripped and refinished with a nonhazardous coating in lieu of destruction. Stripping shall be in conformance with Occupational Safety and Health Administration (OSHA) regulations at 29 CFR 1910.1025 which specify maximum permissible levels of exposure to airborne concentrations of lead particles and set forth methods of protection.

(4) *Exemptions.* (i) The categories of products listed in paragraph (a)(4)(ii) of this section are exempted from the scope of the ban established by 16 CFR Part 1303, provided that before any utilization, donation, or sales action:

(A) These products bear on the main panel of their label, in addition, to any labeling that may be otherwise required, the signal word *Warning* and the following statement: *Contains Lead. Dried Film of This Paint May be Harmful If Eaten or Chewed.*

(B) These products also bear on their label the following additional statement or its practical equivalent:

Do not apply on toys and other children's articles, furniture, or interior surfaces of any dwelling or facility which may be occupied or used by children. Do not apply on exterior surfaces of dwelling units, such as window sills, porches, stairs, or railings, to which children may be commonly exposed.

KEEP OUT OF REACH OF CHILDREN

(C) The additional labeling requirements contained in 16 CFR 1303.3 and 16 CFR 1500.121 are followed.

(ii) The following products are exempt from the scope of the ban established by 16 CFR part 1303, provided they comply with the requirements of paragraph (a)(4)(i) of this section:

(A) Agricultural and industrial equipment refinish coatings.

(B) Industrial (and commercial) building and equipment maintenance coatings, including traffic and safety marking coatings.

(C) Graphic art coatings (i.e., products marketed solely for application on billboards, road signs, and similar uses and for identification marking in industrial buildings).

(D) Touchup coatings for agricultural equipment, lawn and garden equipment, and appliances.

(E) Catalyzed coatings marketed solely for use on radio-controlled model-powered aircraft.

(iii) The following products are exempt from the scope of the ban established by 16 CFR part 1303 (no cautionary labeling is required):

(A) Mirrors which are part of furniture articles to the extent that they bear lead-containing backing paint.

(B) Artists' paints and related materials.

(C) Metal furniture articles (but not metal children's furniture) bearing factory-applied (lead) coatings.

(b) *Utilization requirements.* (1) Excess lead-containing paint and consumer products bearing lead containing paint which are exempt from the scope of the

Federal Property Management Regulations

§ 101-42.1102-8

ban and are properly labeled as required by 16 CFR part 1303 and paragraph (a)(4) of this section shall be reported or otherwise made available to GSA under §§ 101-43.311 and 101-42.204.

(2) Lead-containing paint and consumer products bearing lead-containing paint available for further Federal use as provided in paragraph (b)(1) of this section may be transferred under §§ 101-43.309 and 101-42.207. The warning statement on the transfer order shall be substantially the same as the label statements required by paragraphs (a)(4)(i) (A) through (C) of this section, and such information shall be made a part of the accountable record of the transferee agency.

(c) *Donation requirements.* (1) Surplus lead-containing paint and consumer products bearing lead-containing paint which are exempt from the scope of the ban, and are properly labeled as required by 16 CFR part 1303 and paragraph (a)(4) of this section may be donated.

(2) The hazardous warning statement on the SF 123 shall be the same as the label statements required by paragraphs (a)(4)(i) (A) through (C) of this section. The recipient shall maintain the hazardous warning statements in the inventory records for the property and furnish appropriate warning information to subsequent recipients. The SF 123 and any other transaction documentation for such property shall contain a certification substantially as follows:

The property requested herein shall be used only as specified in 16 CFR 1303.3 and in no case shall be contacted by children. I agree the Government shall not be liable for personal injuries to, disabilities of, or death of the donee's employees, or any other person arising from or incident to the donation of this property, its use, or its final disposition; and to hold the Government harmless from any or all debts, liabilities, judgments, costs, demands, suits, actions or claims of any nature arising from or incident to the donation of this property, its use, or its final disposition.

(d) *Sales requirements.* (1) Lead-containing paint and consumer products bearing lead-containing paint which are exempt from the scope of the ban and are properly labeled as required by 16 CFR part 1303 and paragraph (a)(4) of this section may be sold under § 101-

45.304, Subpart 101-42.4, and the special requirements of this paragraph (d).

(2) IFBs for such property shall clearly state the hazardous warning statements contained in paragraphs (a)(4)(i) (A) through (C) of this section and appropriate agreement clauses. The bid page shall contain a certification substantially as follows which must be properly executed. Failure to sign the certification may result in the bid being rejected as nonresponsive.

I certify that I have read and fully comprehend the aforementioned terms and conditions of this sale. I shall comply with the applicable Consumer Product Safety Commission regulations set forth in 16 CFR part 1303 if I am the successful bidder. I further agree the Government shall not be liable for personal injuries to, disabilities of, or death of any persons arising from or incident to the sale of this property, its uses, or its final disposition; and to hold the Government harmless from any or all debts, liabilities, judgments, costs, demands, suits, actions, or claims of any nature arising from or incident to the sale of this property, its use, or its final disposition.

(3) Lead-containing paint and consumer products bearing lead-containing paint shall not be sold under the limited sales by holding agencies authority in § 101-45.304.

(e) *Abandonment and destruction.* In no case shall lead-containing paint or consumer products bearing lead-containing paint be abandoned in a manner that would allow acquisition and use of such property. Such products shall be disposed of under § 101-42.406. Empty cans/drums in which lead-containing paint was stored shall also be disposed of in accordance with this § 101-42.1102-7.

§ 101-42.1102-8 United States Munitions List items which require demilitarization.

(a) *General.* The United States Munitions List is located in 22 CFR part 121. A system of demilitarization codes has been developed and an appropriate code assigned to each Munitions List Item (MLI) to describe what, if any, restrictions or actual demilitarization requirements apply to each item. These codes, in addition to demilitarization policy and procedures for all surplus military items which are owned, procured by, or under the control of the

Department of Defense, are contained in the Defense Demilitarization Manual (DoD 4160.21-M-1). This §101-42.1102-8 applies only to MLIs and is to be used in conjunction with guidance in parts 101-42, 101-44, and 101-45.

(b) *Utilization requirements.* (1) Federal agencies acquiring MLIs which require demilitarization shall perpetuate the demilitarization codes in their property records and on subsequent reports of excess personal property submitted to GSA. Demilitarization shall be a condition of transfer of excess MLIs.

(2) Utilization without demilitarization of other than classified material is authorized only under the conditions cited in the Defense Demilitarization Manual, DoD 4160.21-M-1.

(c) *Donation requirements.* (1) Donation without demilitarization of other than classified material is authorized only under the conditions cited in the Defense Demilitarization Manual, DoD 4160.21-M-1.

(2) A State agency requesting the transfer of donation of MLIs identified as requiring demilitarization shall include the appropriate demilitarization code on the SF 123, and a statement that the State agency will obtain from the donee a certification that prior to further disposition, demilitarization of the property shall be performed by the donee under the demilitarization instructions for the code as set forth in the Defense Demilitarization Manual, DoD 4160.21-M-1. In the case of MLIs requested for donation by service educational activities or public airports pursuant to the provisions of subparts 101-44.4 and 101-44.5 respectively, the donee shall include a statement on the SF 123 certifying that appropriate demilitarization of the property will be accomplished under the requirements of the codes before further disposition.

(3) Before disposing of MLIs identified as requiring demilitarization, donees may request demilitarization instructions from GSA through the State agency if the donation was made pursuant to subpart 101-44.2. Demilitarization instructions for such items donated to public airports, under subpart 101-44.5, may be requested through the Federal Aviation Administration. Demilitarization instructions for such items donated to service educational

activities under subpart 101-44.4 may be obtained directly from the Item Technical Manager within DOD for the item involved.

(4) Demilitarization of property to be donated to public bodies under subpart 101-44.7 shall be accomplished in a manner to preserve so far as possible any civilian use or commercial value of the property, as prescribed in the minimum demilitarization requirements of the Defense Demilitarization Manual, DoD 4160.21-M-1.

(d) *Sales requirements.* (1) Except for sales authorized by statute, sales of “explosives” and “ammunition components” authorized by paragraphs (d) (2) and (3) of this section, or specialized sales authorized by the Secretary of Defense, MLIs identified as requiring demilitarization shall not be reported for public sale without first being demilitarized under the requirements of the assigned code in the Defense Demilitarization Manual, DoD 4160.21-M-1 or requiring demilitarization under the terms and conditions of sale. GSA will, as necessary, refer technical questions on demilitarization to the Department of Defense.

(2) *Explosives.* For the purpose of this section, the term *explosive* means any chemical compound, mixture, or device, the primary or common purpose of which is to function by explosion. The term includes, but is not limited to, dynamite and other high explosives, black powder, pellet powder, initiating explosives, detonators, safety fuses, squibs, detonating cord, igniter cord, igniters, and any other items appearing in the explosives list issued by the Secretary of the Treasury (18 U.S.C. 841(d)). The explosives list is published and revised at least annually in the Federal Register by the Director, Bureau of Alcohol, Tobacco and Firearms, Department of the Treasury, as required by 27 CFR 55.23. The following procedures shall apply in any disposal of explosives:

(i) All explosives offered for sale shall be properly identified in the offering with respect to their hazardous characteristics.

(ii) All explosives shall be labeled by the holding agency before shipment so that their hazardous or dangerous

Federal Property Management Regulations

§ 101-42.1102-9

character will be immediately evident upon inspection.

(iii) Purchasers of explosives shall be required, as a condition of sale, to execute the following certification:

It is hereby certified that the purchaser will comply with all applicable Federal, State, and local laws, ordinances, and regulations with respect to the care, handling, storage, shipment, resale, export, and other use of the materials, hereby purchased, and that he/she is a user of, or dealer in, said materials and will comply with all applicable Federal, State, and local laws. This certification is made in accordance with and subject to the penalties of Title 18, Section 1001, the United States Code, Crime and Criminal Procedures.

(3) *Ammunition components.* The term "ammunition components" means ammunition or cartridge cases, primers, bullets, or propellant powder designed for use in any firearm. The transportation of primers or propellant powder is governed by the Hazardous Materials Regulations (49 CFR parts 170-189) promulgated by the Department of Transportation. Purchasers of such materials are responsible to certify, based on their own examination, that the materials are properly classified, described, packaged, marked, and labeled and are in proper condition for transportation in accordance with the Hazardous Materials Regulations. So that bidders will be notified of the special requirements concerning the purchase and transportation of usable ammunition components, the following statement shall be included in the IFBs and shall be made a part of the contract by including in it the bid form to be submitted by the bidders:

Item No. _____ contains ammunition components offered for sale in this invitation. The undersigned certifies that he/she will comply with all applicable local, State, and Federal laws and regulations concerning ammunition components.

(4) *Scrap ammunition components.* Ammunition components not usable or suitable for reuse as components of ammunition shall be reported and may be sold as scrap (for basic material content). With regard to such sale, the following statement shall be included in the invitation for bid and shall be made a part of the contract:

I, _____, certify that ammunition components purchased by me as Item No. _____, will not be used for the original manufactured purpose.

(e) *Abandonment and destruction requirements.* Besides the requirement of subpart 101-45.9, surplus munitions list items which require demilitarization shall be abandoned or disposed of under the requirements of §101-42.406, but only after performance of demilitarization under the requirements of the assigned code in the Defense Demilitarization Manual, DoD 4160.21-M-1.

§ 101-42.1102-9 Acid contaminated and explosive contaminated property.

(a) *Utilization requirements.* (1) Acid contaminated or explosive contaminated property shall be considered extremely hazardous property, and as such is not to be reported to GSA as excess personal property. Such property may be available for transfer to qualified recipients; i.e., those who are able to submit valid justifications as required by paragraph (a)(3) of this section.

(2) Excess acid contaminated or explosive contaminated property shall be properly labeled under the labeling requirements of §101-42.204.

(3) With the authorization of the appropriate GSA regional office, holding activities may transfer acid contaminated or explosive contaminated property in conformance with the requirements of §§101-43.309-5 and 101-42.207. In addition, the requesting agency must submit a written justification with the transfer order explaining the specific need for and the anticipated uses of the requested acid or explosive contaminated property, and certify that personnel in contact with the property shall be informed of the hazard and shall be qualified to safely handle or use it.

(4) The degree of decontamination and the responsibility for performance and costs of any decontamination shall be upon such terms as agreed to by the owning agency and the receiving agency.

(5) The receiving agency is responsible for all transportation arrangements and costs of acid contaminated or explosive contaminated property approved for transfer. Such property

§ 101-42.1102-10

shall be transported in compliance with §101-42.405.

(b) *Donation requirements.* Acid contaminated and explosive contaminated property may be donated only with the authorization of the appropriate GSA regional office.

(c) *Sales requirements.* (1) With the authorization of the appropriate GSA regional office, holding activities may sell acid contaminated or explosive contaminated property under §101-45.304, subpart 101-42.4, and the additional special requirements of this paragraph (c). Agencies shall include in reports of such property for sale on SF 126, a statement of the degree of contamination and any decontamination that has been performed, such as a washdown.

(2) Acid or explosive contaminated property shall be considered extremely hazardous property as defined in §101-42.001, and shall be described as such in sales offerings. Normally, acid or explosive contaminated property shall be sold with a condition that the purchaser sufficiently decontaminate the property to the degree that it is no longer extremely hazardous.

(3) IFBs for acid or explosive contaminated property shall clearly state the specific hazards associated with the items offered, along with known special handling, transportation, and personnel protection requirements. The bid page shall contain a certification substantially as follows which must be properly executed by the bidder in order for the bid to be responsive:

CERTIFICATION: It is hereby certified that the purchaser will comply with all the applicable Federal, State, and local laws ordinances and regulations with respect to the care, handling, storage, and shipment, resale, export, and other use of the materials, hereby purchased, and that he/she is a user of, or dealer in, said materials and will comply with all applicable Federal, State, or local laws and regulations. This certification is made in accordance with and subject to the penalties of Title 18, Section 1001, the United States Code, Crime and Criminal Procedures.

(d) *Abandonment and destruction.* Acid contaminated or explosive contaminated property shall not be abandoned, and when destroyed, such destruction shall be accomplished under the provi-

41 CFR Ch. 101 (7-1-01 Edition)

sions of subparts 101-45.9 and §101-42.406.

§ 101-42.1102-10 Firearms.

(a) *Utilization requirements.* (1) In accordance with §101-43.4801(c) of this chapter, reports of excess reportable firearms and requests for their transfer must be submitted to the:

General Services Administration (7FP-8),
Denver, CO 80225-0506.

(2) Firearms may be transferred only to those Federal agencies authorized to acquire firearms for official use. Such transfers must be executed under §101-43.309-5 of this chapter and, when applicable, §101-42.1102-8(b). Additional written justification from the requesting agency may be required.

(b) *Donation requirements.* (1) Only handguns, rifles, shotguns, and individual light automatic weapons, all less than .50 caliber in FSC 1005, and rifle and shoulder fired grenade launchers in FSC 1010, assigned a disposal condition code of 4 or better, as defined in §101-43.4801(e) of this chapter, may be offered by GSA (7FP-8) to State agencies for donation to eligible law enforcement entities for law enforcement purposes only. Donations are limited to only those eligible law enforcement entities whose primary function is the enforcement of applicable Federal, State, and/or local laws, and whose compensated law enforcement officers have powers to apprehend and arrest. Such donations must be executed under §101-42.1102-8(c) as applicable.

(2) Each SF 123 submitted to GSA must be accompanied by a conditional transfer document, signed by both the intended donee and the State agency, and containing the special terms, conditions, and restrictions prescribed by GSA, and any other required forms or information.

(3) The restrictions on donated firearms shall be in perpetuity, and they may not be released by the State agency without prior written approval from GSA. The donee must notify the State agency when donated firearms are no longer needed. The State agency may, with GSA approval, reassign firearms from one donee to another donee within the state or to another SASP (see

Federal Property Management Regulations

Pt. 101-44

§101-44.205(f) of this chapter); otherwise, firearms must be delivered directly to the place of destruction to be destroyed by either the donee or the State agency. Destruction must be such that each complete firearm is rendered completely inoperable and incapable of being made operable for any purpose except for the recovery of basic material content in accordance with paragraph (c) of this section. The donee and a representative from the State agency, or designee, must both state in writing that the firearms were so destroyed and the original signed statement must be maintained by the State agency.

(4) Surplus firearms approved for donation must be shipped or transported directly from the holding Federal agency to the donee, and may not be stored in the State agency warehouse; or, arrangements may be made by the State agency for the designated donee to make a direct pickup at the holding agency.

(5) Firearm ammunition may not be donated.

(c) *Sales requirements.* Surplus firearms may be sold only for scrap after total destruction by crushing, cutting, breaking, or deforming to be performed in a manner to ensure that the firearms are rendered completely inoperative and to preclude their being made operative. Such sale shall be conducted under subpart 101-45.3.

(d) *Foreign gifts of firearms.* Firearms reported to GSA as foreign gifts may be offered for transfer to Federal agencies, including law enforcement activities. Foreign gifts of firearms shall not be donated. Such gifts not required for Federal use may be sold only to the gift recipient at the discretion of GSA. A certification that the purchaser shall comply with all State and local laws regarding purchase and possession of firearms must be received by GSA prior to release of such firearms to the purchaser. Firearms not transferred to a Federal agency or sold to the recipient shall be disposed of in accordance with paragraph (c) or (e) of this section.

(e) *Abandonment and destruction of firearms.* Firearms shall not be abandoned. Destruction of firearms is subject to the requirements set forth in paragraph (c) of this section. Such de-

struction shall also be accomplished under the provisions of subpart 101-45.9, §101-42.406 and, when applicable, §101-42.1102-8.

(f) *Abandoned and forfeited firearms.* In addition to the requirements of this part 101-42, forfeited or voluntarily abandoned firearms shall be subject to the provisions of part 101-48.

[57 FR 39121, Aug. 28, 1992, as amended at 64 FR 40772, July 28, 1999]

PART 101-43—UTILIZATION OF PERSONAL PROPERTY

AUTHORITY: 40 U.S.C. 486(c); Sec. 205(c), 63 Stat. 390.

SOURCE: 65 FR 31218, May 16, 2000, unless otherwise noted.

§101-43.000 Cross-reference to the Federal Management Regulation (FMR) (41 CFR chapter 102, parts 102-1 through 102-220).

For information on the disposition of excess personal property previously contained in this part, see FMR part 36 (41 CFR part 102-36).

PART 101-44—DONATION OF PERSONAL PROPERTY

Sec.

101-44.000	Scope of part.
101-44.001	Definitions of terms.
101-44.001-1	Agricultural commodity.
101-44.001-2	[Reserved]
101-44.001-3	Donable property.
101-44.001-4	Donee.
101-44.001-5	[Reserved]
101-44.001-6	Local government.
101-44.001-7	[Reserved]
101-44.001-8	Motor vehicle.
101-44.001-9	No commercial value.
101-44.001-10	Public agency.
101-44.001-11	Public body.
101-44.001-12	Service educational activity.
101-44.001-13	State.
101-44.001-14	State agency.
101-44.002	Requests for deviations.

Subpart 101-44.1—General Provisions

101-44.101	Withdrawal of donable property.
101-44.102	Responsibilities of holding agencies.
101-44.103	[Reserved]
101-44.104	Costs incurred incident to donation.
101-44.105	Assistance in major disaster relief.

Pt. 101-44

- 101-44.106 [Reserved]
- 101-44.107 Donation of property withdrawn from sale.
- 101-44.108 Donation of special categories of property.
 - 101-44.108-1 Medical materials and supplies and shelf-life items.
 - 101-44.108-2 Donation of aircraft.
 - 101-44.108-3—101-44.108-4 [Reserved]
 - 101-44.108-5 Bedding and upholstered furniture.
 - 101-44.108-6 Tax-free alcohol or specially denatured alcohol.
 - 101-44.108-7 Franked and penalty envelopes and paper with official letterhead.
 - 101-44.108-8 [Reserved]
 - 101-44.108-9 Donation of vessels.
 - 101-44.108-10 [Reserved]
 - 101-44.109 Donation screening period.
 - 101-44.110 Transfer orders for surplus personal property.
 - 101-44.111 Preparation and processing of transfer orders.
 - 101-44.112 Approval or disapproval of transfer orders.
 - 101-44.113 Rejection of property approved for transfer.
 - 101-44.114 Pickup or shipment.
 - 101-44.115 Overages and shortages.
 - 101-44.116 Certification of screeners.
 - 101-44.117 Recovery of property for Federal use.
 - 101-44.118 Nondiscrimination.
 - 101-44.119 [Reserved]

Subpart 101-44.2—Donations to Public Agencies and Eligible Nonprofit Tax-Exempt Activities

- 101-44.200 Scope of subpart.
- 101-44.201 Authority.
- 101-44.202 State agency plan of operation.
- 101-44.203 Allocation of donable property.
- 101-44.204 Certification and agreement by a State agency.
- 101-44.205 Property in the possession of a State agency.
- 101-44.206 Cooperative agreements.
- 101-44.207 Eligibility.
- 101-44.208 Property distributed to donees.

Subpart 101-44.3—Donations of Foreign Excess Personal Property

- 101-44.300 Scope of subpart.
- 101-44.301 Holding agency responsibilities.
- 101-44.302 Donation screening.
- 101-44.303 Donation approval.
- 101-44.304 Shipment.
- 101-44.305 Costs incurred incident to donation.
- 101-44.306 Statistics and reports.

41 CFR Ch. 101 (7-1-01 Edition)

Subpart 101-44.4—Donations to Service Educational Activities

- 101-44.400 What are the responsibilities of DOD, GSA, and State agencies in the Service Educational Activity (SEA) donation program?
- 101-44.401 How is property for SEAs allocated and distributed?
- 101-44.402 May SEAs acquire non-DOD property?
- 101-44.403 What if a provision in this subpart conflicts with another provision in this part 101-44?

Subpart 101-44.5—Donations to Public Airports

- 101-44.500 General.
- 101-44.501 Agency authority.
- 101-44.502 Application.
- 101-44.503 Surveillance.
- 101-44.504 Reports.

Subpart 101-44.6—Donations to the American National Red Cross

- 101-44.600 General.
- 101-44.601 Donation approval.
- 101-44.602 Cooperation of holding agencies.
- 101-44.603 Action by the Red Cross.
- 101-44.604 Transfer by holding agency.
- 101-44.605 Donable property determined unusable by the Red Cross.

Subpart 101-44.7—Donations of Property to Public Bodies

- 101-44.700 Scope of subpart.
- 101-44.701 Findings justifying donation to public bodies.
 - 101-44.701-1 General.
 - 101-44.701-2 Reviewing authority.
- 101-44.702 Donations to public bodies.
 - 101-44.702-1 Authority to donate.
 - 101-44.702-2 Disposal costs.
 - 101-44.702-3 Hazardous materials.

Subpart 101-44.8—[Reserved]

Subpart 101-44.9—Miscellaneous Statutes

- 101-44.900 Scope of subpart.
- 101-44.901 Condemned or obsolete material.
- 101-44.902 Obsolete, condemned, or captured vessels.
- 101-44.903 Obsolete naval material.
- 101-44.904 Obsolete material and articles of historic interest.
- 101-44.905 Obsolete or other Coast Guard material.

Subparts 101-44.10—101-44.46 [Reserved]

Subpart 101-44.47—Reports

- 101-44.4701 Reports.

Federal Property Management Regulations

§ 101-44.001-6

Subpart 101-44.48 [Reserved]

Subpart 101-44.49—Illustrations of Forms

- 101-44.4900 Scope of subpart.
- 101-44.4901 Standard forms.
- 101-44.4901-123 Standard Form 123, Transfer Order Surplus Personal Property.
- 101-44.4901-123-A Standard Form 123-A, Transfer Order Surplus Personal Property (Continuation sheet).
- 101-44.4901-123-1 Instructions for preparing and processing Standard Form 123.
- 101-44.4902 GSA forms.
- 101-44.4902-3040 GSA Form 3040, State Agency Monthly Donation Report of Surplus Personal Property.
- 101-44.4902-3040-1 Instructions for preparing GSA Form 3040.

AUTHORITY: Sec. 205(c), 63 Stat. 390; 40 U.S.C. 486(c).

SOURCE: 42 FR 56003, Oct. 20, 1977, unless otherwise noted.

§ 101-44.000 Scope of part.

This part prescribes policies and methods governing the donation of surplus personal property located within the United States, the District of Columbia, the Commonwealth of Puerto Rico, the Trust Territory of the Pacific Islands, the Virgin Islands, Guam, American Samoa, and the Commonwealth of the Northern Mariana Islands, and the donation of foreign excess personal property designated for return to the United States. Additional guidelines regarding the donation of hazardous materials and certain categories of property are prescribed in part 101-42.

[57 FR 39136, Aug. 28, 1992]

§ 101-44.001 Definitions of terms.

For the purposes of this part 101-44 the following terms shall have the meanings set forth in this section.

§ 101-44.001-1 Agricultural commodity.

Agricultural commodity means a product resulting from the cultivation of the soil or husbandry on farms and in the form customarily marketed by farmers.

§ 101-44.001-2 [Reserved]

§ 101-44.001-3 Donable property.

Donable property means surplus property under the control of an executive

agency (including surplus personal property in working capital funds established under 10 U.S.C. 2208 or in similar management-type funds) except:

(a) Such property as may be specified from time to time by the Administrator of General Services;

(b) Surplus agricultural commodities, food, and cotton or woolen goods determined from time to time by the Secretary of Agriculture to be commodities requiring special handling to assist him in carrying out his responsibilities with respect to price support or stabilization;

(c) Property in trust funds; or

(d) Nonappropriated fund property.

§ 101-44.001-4 Donee.

Donee means a service educational activity; a State, political subdivision, municipality, or tax-supported institution acting on behalf of a public airport; a public agency using surplus personal property in carrying out or promoting for the residents of a given political area one or more public purposes, such as conservation, economic development, education, parks and recreation, public health, and public safety; an eligible nonprofit tax-exempt educational or public health institution or organization; the American National Red Cross; a public body; an eleemosynary institution; or any State or local government agency, and any nonprofit organization or institution, which receives funds appropriated for programs for older individuals under the Older Americans Act of 1965, as amended, under title IV or title XX of the Social Security Act, or under titles VIII and X of the Economic Opportunity Act of 1964 and the Community Services Block Grant Act.

[53 FR 16106, May 5, 1988]

§ 101-44.001-5 [Reserved]

§ 101-44.001-6 Local government.

Local government means a government, or administration of a locality, within a State or a possession of the United States.

§ 101-44.001-7

41 CFR Ch. 101 (7-1-01 Edition)

§ 101-44.001-7 [Reserved]

§ 101-44.001-8 Motor vehicle.

Motor vehicle means a conveyance self-propelled or drawn by mechanical power, designed to be principally operated on the streets and highways in the transportation of property or passengers.

§ 101-44.001-9 No commercial value.

No commercial value means a determination that property has neither utility nor monetary value (either as an item or as scrap).

[53 FR 16106, May 5, 1988]

§ 101-44.001-10 Public agency.

Public agency means any State; political subdivision thereof, including any unit of local government or economic development district; any department, agency, or instrumentality thereof, including instrumentalities created by compact or other agreement between States or political subdivisions; multi-jurisdictional substate districts established by or pursuant to State law; or any Indian tribe, band, group, pueblo, or community located on a State reservation.

§ 101-44.001-11 Public body.

Public body means any State, territory, or possession of the United States; any political subdivision thereof; the District of Columbia; the Commonwealth of Puerto Rico; any agency or instrumentality of any of the foregoing; any Indian tribe; or any agency of the Federal Government.

§ 101-44.001-12 Service educational activity.

Service educational activity means any educational activity designated by the Secretary of Defense as being of special interest to the armed services; e.g., maritime academies or military, naval, Air Force, or Coast Guard preparatory schools.

§ 101-44.001-13 State.

State means one of the 50 States, the District of Columbia, the Commonwealth of Puerto Rico, the Virgin Is-

lands, Guam, American Samoa, and the Commonwealth of the Northern Mariana Islands.

[53 FR 16106, May 5, 1988]

§ 101-44.001-14 State agency.

State agency means the agency in each State designated under State law as responsible for the distribution within the State of all donations of surplus property to public agencies and eligible nonprofit tax-exempt activities.

[53 FR 16106, May 5, 1988]

§ 101-44.002 Requests for deviations.

Deviations from the regulations in this part shall only be granted by the Administrator of General Services (or designee). Requests for deviations shall be made in writing to the General Services Administration (FB), Washington, DC 20406, with complete justification. A copy of the authorizing statement for each deviation, including the nature of the deviation, the reasons for such special action, and the Administrator's or designee's approval, will be available for public inspection in accordance with subpart 105-60.3 of this title.

[53 FR 16106, May 5, 1988]

Subpart 101-44.1—General Provisions

§ 101-44.101 Withdrawal of donable property.

Surplus personal property set aside or approved for donation may be withdrawn for use by the holding agency with the prior approval of GSA. Holding activities may withdraw such property to meet their essential valid requirements in emergency situations without prior approval of GSA, but shall notify GSA immediately of such actions. The GSA regional office will advise the State agency or donee which applied for the property at the time a withdrawal is approved by GSA.

[53 FR 16106, May 5, 1988]

Federal Property Management Regulations

§ 101-44.105

§ 101-44.102 Responsibilities of holding agencies.

The role of agencies, other than State agencies, holding Federal property pending donation shall be limited to the following:

(a) Holding agencies shall cooperate fully with all agencies and their duly accredited representatives authorized to participate in the donation program in locating, screening and inspecting surplus personal property for donation. Upon reasonable request, holding agencies shall make available to these agencies or their representatives complete information regarding the quantity, description, condition, and location of donable property in their inventories. Holding agencies, however, need not prepare nor mail reports or listings not otherwise required by their procedures.

(b) Each holding agency shall annotate nonreportable personal property records to indicate to authorized State agencies, donee representatives or responsible Federal officials the date of the surplus determination by the holding agency.

(c) Pending donation, each holding agency shall be responsible for performing, and bearing the cost for, the care and handling of its property. Direct costs incurred by the holding agency in the actual packing, preparation for shipment, and loading of property incident to the donation may be reimbursable. Holding agencies may waive the amount involved as being uneconomical or impractical to collect. Where such charges are incurred, they shall be reimbursed promptly by the State agency or designated donee upon appropriate billing. Overhead or administrative costs or charges shall not be included.

(d) Holding agencies shall provide a period of 21 calendar days following the surplus release data for donation screening in accord with §101-44.109. During this period, a holding activity shall not take for its own use any property in its custody, except as provided in §101-44.101.

(e) Surplus property set aside for donation (see §101-44.109) shall be retained by the holding agency for a period not to exceed 42 calendar days from the surplus release date, pending

receipt of an approved Standard Form (SF) 123, Transfer Order Surplus Personal Property, from GSA and firm instructions for pickup or shipment of the property. The transferee is responsible for removing the property or for making arrangements with common carriers for its shipment. Property disposal officers or other representatives of holding activities shall not act as the agent or shipper for transferees in this regard. Upon receipt of the approved SF 123 and instructions for pickup or shipment, the holding activity shall promptly notify the transferee or the transferee's designated agent of the availability of the property. At the end of the 42-day period, the holding agency may proceed with the disposal of the property if the approved SF 123 and pickup or shipping instructions have not been received.

(f) Surplus property shall not be released by a holding activity for donation until the activity has received an SF 123 bearing the signed approval of the appropriate GSA official.

[53 FR 16106, May 5, 1988]

§ 101-44.103 [Reserved]

§ 101-44.104 Costs incurred incident to donation.

Direct costs incurred by the holding agency in packing, loading, or preparing the property for shipment shall be borne by the State agency or the designated donee. Where such costs are incurred, they shall be reimbursed promptly by the State agency or designated donee upon appropriate billing, unless the holding agency waives the amount involved as being uneconomical or impractical to collect.

[53 FR 16107, May 5, 1988]

§ 101-44.105 Assistance in major disaster relief.

(a) Upon declaration by the President of an emergency or a major disaster, surplus equipment and supplies may be donated to State and local governments for use and distribution by them for emergency or major disaster assistance purposes in accordance with the directions of the Federal Emergency Management Agency (FEMA) pursuant to the Disaster Relief Act of 1974 (Pub. L. 93-288) and Executive Order 12148, as

§ 101-44.106

amended. All donations of surplus personal property for major disaster assistance purposes require the prior approval of GSA, except where property already transferred for donation is donated to eligible donees by the State agency.

(b) When Federal surplus property in the custody of a State agency is requested by the State official in charge of disaster operations, and certified by FEMA as being usable and needed, the State agency will release the property to the authorized State official.

(c) Reimbursement to the State agency releasing surplus property for disaster assistance will be made by the State receiving the property. If reimbursement is sought, the State agency should coordinate and make arrangements with the State official in charge of disaster relief for reimbursement for services provided. In addition to services rendered, State agencies are entitled to reimbursement of documented expenses originally incurred in the care and handling of the property, including the screening, transporting, and receipt of property made available for disaster relief.

(d) Property previously obtained from or through the State agency for disaster relief purposes, and not used or no longer required, shall be returned to the State agency. Such property received by the State agency will be accounted for and disposed of in the same manner as any other property approved for donation under normal circumstances.

(e) Federal assistance under the Disaster Relief Act of 1974 is terminated upon notice to the Governor of the State by the Director, FEMA, or at the expiration of time periods prescribed in FEMA regulations, whichever occurs first.

[53 FR 16107, May 5, 1988]

§ 101-44.106 [Reserved]

§ 101-44.107 Donation of property withdrawn from sale.

Surplus personal property which is being offered for sale may be withdrawn and approved for donation: *Provided*, The property was not previously made available for donation or such action is not harmful to the sale, as

41 CFR Ch. 101 (7-1-01 Edition)

jointly determined by GSA and the holding or selling agency. Withdrawal must be made before the award of such property. The State agency or donee requesting withdrawal of property from sale for purposes of donation shall submit the request to GSA for consideration and coordination with the selling agency. The request shall include a justification and a statement of whether the property had been available for screening during the authorized donation screening period.

§ 101-44.108 Donation of special categories of property.

The Administrator of General Services is authorized under section 203(j)(4) of the Federal Property and Administrative Services Act of 1949, as amended, as circumstances warrant, to impose appropriate conditions on the donation of property having characteristics that require special handling or use limitations. In exercising his discretion the Administrator may, a case-by-case basis, prescribe additional restrictions covering the handling or use of such property.

§ 101-44.108-1 Medical materials and supplies and shelf-life items.

(a) Medical materials and supplies consisting of drugs, biologicals, reagents, or controlled substances shall be donated in accordance with the provisions of §§ 101-42.1102-3 and 101-42.1102-5.

(b) Non-restricted medical materials and supplies may be donated in accordance with the provisions of this part 101-44.

(c) In the case of restricted medical materials and supplies (medical items that must be dispensed or used only by a licensed, registered, or certified individual) requested by a State agency, the SF 123 shall contain a statement that:

(1) The listed property will be transferred from the holding agency directly to the designated donee;

(2) The intended donee is licensed and authorized to administer and dispense such items or is authorized to store the items; and

(3) The State agency will obtain a certification from the donee indicating that:

Federal Property Management Regulations

§ 101-44.108-2

(i) The items transferred to the donee institution or organization will be safeguarded, dispensed, and administered under competent supervision;

(ii) Adequate facilities are available to effect full accountability and proper storage of the items in accordance with Federal, State, and local statutes governing their acquisition, storage, and accountability; and

(iii) The administration or use of the items requested will comply with the provisions of the Federal Food, Drug, and Cosmetic Act, as amended (21 U.S.C. 301-394).

(d) A State agency shall not pick up or store in its distribution center, surplus restricted medical materials and supplies. This property shall be transferred from the holding agency directly to the designated donee.

(e) Shelf-life items and medical materials and supplies held for national emergency purposes, and determined to be surplus in accordance with § 101-43.307-13, shall be made available for donation screening as provided in § 101-44.109.

[57 FR 39136, Aug. 28, 1992]

§ 101-44.108-2 Donation of aircraft.

This section provides procedures and conditions for the donation of aircraft which are not classified for reasons of national security and after removal of lethal characteristics. The requirements of this paragraph apply to the donation of any fixed- or rotary-wing aircraft with a unit acquisition cost of \$5,000 or more, but do not apply to the donation of individual aircraft components, accessories, parts, or appurtenances not attached to or an integral part of an aircraft. Combat-type aircraft shall not be donated for flight use.

(a) *Plan of utilization.* To assist GSA in the allocation and transfer of available surplus aircraft, each SF 123 submitted to GSA for donation of an aircraft covered by this section shall include a letter of intent, signed and dated by the authorized representative of the proposed donee, setting forth a detailed plan of utilization for the property. The letter of intent shall provide the following information:

(1) A description of the aircraft requested, including the type, model or

size, and the serial number, if it is known;

(2) A detailed description of the donee's program and the number and types of aircraft currently owned by the donee;

(3) Whether the aircraft is to be used for flight purposes or nonflight purposes (including ground instruction or simulation use), and details of the planned utilization of the aircraft including but not limited to how the aircraft will be used, its purpose, how often and for how long. If for flight purposes, specify source of pilot(s) and where aircraft will be housed. When the aircraft is requested for cannibalization (recovery of parts and components), the letter of intent should provide details of the cannibalization process (time to complete the cannibalization process, how recovered parts are to be used, method of accounting for usable parts, etc.); and

(4) Any supplemental information (such as geographical area and population served, number of students enrolled in educational programs, etc.) supporting the donee's need for the aircraft.

(b) *Donation of aircraft to public agencies and eligible nonprofit tax-exempt activities.* (1) For the donation of an aircraft to a donee eligible in accordance with the provisions of subpart 101-44.2, the following documentation shall be submitted to GSA along with the SF 123 and the donee's letter of intent:

(i) A letter, signed and dated by the State agency director, confirming and certifying the applicant's eligibility and containing the State agency's evaluation of the applicant's ability to use the aircraft for the purpose stated in its letter of intent and any other supplemental information concerning the needs of the donee which supports making the allocation;

(ii) A State agency distribution document, signed and dated by the authorized representative of the donee, and containing the terms, conditions, and restrictions prescribed by GSA; and

(iii) A conditional transfer document, signed by both the donee and the State agency, and containing the special terms, conditions, and restrictions prescribed by GSA. The conditional transfer document may include additional

State agency imposed terms, conditions, and restrictions on the use of the aircraft which are consistent with any Federal requirements or the State plan of operation. However, none of the Federal terms, conditions, and restrictions outlined in the executed conditional transfer document, including the requirement for an additional 48-month period of approved use, shall be modified, amended, waived, released, or abrogated by the State agency without the prior written approval of GSA.

(2) Donation of aircraft to public agencies and eligible nonprofit tax-exempt activities shall be subject to the following terms, conditions, and restrictions:

(i) The donee shall apply to the Federal Aviation Administration (FAA) for registration of an aircraft intended for flight use within 30 calendar days of receipt of the aircraft. The donee's application for registration shall include a fully executed copy of the conditional transfer document and a copy of its letter of intent. If the aircraft is to be flown as a civil aircraft, the donee must obtain an FAA Standard Airworthiness Certificate within 12 months of receipt of the aircraft. The donee shall provide the State agency and GSA with a copy of the FAA registration and the Standard Airworthiness Certificate.

(ii) The aircraft shall be used solely in accordance with the executed conditional transfer document and the plan of utilization set forth in the donee's letter of intent, unless the donee has amended the letter and it has been approved in writing by the State agency and GSA and a copy of the amendment recorded with FAA.

(iii) Combat-type aircraft, as designated by DOD, shall not be donated for flight purposes. The restrictions on combat-type aircraft shall be in perpetuity and shall not be released by the State agency without the prior written approval of the GSA Central Office.

(iv) In the event any of the terms, conditions, and restrictions imposed by the conditional transfer document are breached, title and right to the possession of the aircraft shall, at the option of GSA, revert to the United States of America. The donee, at the option of GSA, shall be liable to the United

States of America for the proceeds from any unauthorized disposal or for the fair market value or fair rental value of the aircraft at the time of any unauthorized transaction or use, as determined by GSA.

(v) If, during the period of restriction, the aircraft is no longer suitable, usable, or further needed by the donee for the purpose for which it was acquired, the donee shall promptly notify the State agency and request disposal instructions. Disposal instructions shall not be issued by the State agency except with the prior written concurrence of GSA.

(vi) In the case of any noncombat aircraft donated for nonflight use, and for all combat-type aircraft (unless certified by the Defense Reutilization and Marketing Office that the historical records and data plate have already been removed by the disposal agency), the State agency shall acquire from the donee, within 30 calendar days of the donee's receipt of the aircraft, the aircraft historical records (except the records of the major components/life limited parts; e.g., engines, transmissions, rotor blades, etc., necessary to substantiate their reuse) and the manufacturer's aircraft data plate and turn them over to the GSA allocating office. GSA will forward the records and data plates to the Chief, Aircraft Manufacturing Division, Office of Airworthiness, Federal Aviation Administration, 800 Independence Avenue SW., Washington, DC 20591.

(c) *Donation of aircraft to service educational activities.* (1) Donation of a surplus Department of Defense (DOD) aircraft to a donee eligible in accordance with the provisions of subpart 101-44.4 shall be made in accordance with the terms of the individual donation agreement executed by DOD and the service educational activity. The SF 123, with the donee's letter of intent and any additional required documentation specified, shall be submitted for approval to the appropriate GSA regional office.

(2) Surplus DOD aircraft which have been demilitarized may be approved for donation by GSA to service educational activities for nonflight use, for static display, or for ground instruction and simulation purposes.

Federal Property Management Regulations

§ 101-44.108-9

(3) Surplus DOD noncombat and commercial-type aircraft may be approved for donation by GSA at the request of DOD for flight purposes by service educational activities subject to the following use conditions and agreements which DOD shall require of the donee:

(i) The aircraft shall be used solely in connection with the plan of utilization set forth in the donee's letter of intent unless DOD authorizes a change in writing to the donee's plan of utilization.

(ii) The donee shall apply to FAA for registration (and shall provide FAA with a copy of its letter of intent) within 30 calendar days of receipt of the aircraft and shall forward a copy of the registration to DOD and GSA.

(iii) The aircraft must be certified as airworthy prior to being put into flight use. The donee shall furnish a copy of the FAA Standard Airworthiness Certificate to DOD and GSA.

(d) *Donation of aircraft for public airport purposes.* (1) When a surplus aircraft is donated to a donee eligible in accordance with the provisions of subpart 101-44.5, the SF 123 and the donee's letter of intent shall be processed by and through FAA and submitted to GSA for approval.

(2) Surplus cannibalized or demilitarized aircraft may be approved for donation by GSA to a public airport for use in firefighting and rescue training.

(3) Flyable aircraft will not be approved for donation for public airport purposes.

(e) *Donation of condemned or obsolete combat aircraft for historical purposes.* Requests for donation of aircraft for historical purposes (museums, static display, etc.) from veterans' organizations, soldiers' monument associations, State museums, incorporated nonprofit educational museums, municipal corporations (cities, boroughs or incorporated towns), and Sons of Veterans Reserve shall be referred to DOD for processing in accordance with 10 U.S.C. 2572 (see §101-44.901).

[53 FR 16108, May 5, 1988]

§§ 101-44.108-3—101-44.108-4 [Reserved]

§ 101-44.108-5 Bedding and upholstered furniture.

An SF 123 submitted to a GSA regional office for donation of bedding and upholstered furniture will not be approved by GSA unless the State agency or other donee includes a statement that the material will be treated in accordance with applicable State law and regulations before reuse.

§ 101-44.108-6 Tax-free alcohol or specially denatured alcohol.

(a) When tax-free or specially denatured alcohol is requested for donation, the donee must possess a special permit issued by the Assistant Regional Commissioner of the appropriate regional office, Bureau of Alcohol, Tobacco, and Firearms (BATF), Department of the Treasury, to acquire the property.

(b) An SF 123 submitted to a GSA regional office for donation of tax-free or specially denatured alcohol will not be approved by GSA unless the appropriate BATF use-permit number is shown.

(c) A State agency shall not store tax-free or specially denatured alcohol in distribution centers. This property shall be transferred from holding activities direct to the designated donee.

§ 101-44.108-7 Franked and penalty envelopes and paper with official letterhead.

An SF 123 submitted to a GSA regional office for donation of paper with an official letterhead or for donation of franked or penalty envelopes on which the penalty indicia has not been obliterated will not be approved by GSA unless the State agency or other donee includes a statement certifying that the indicia and all other Federal Government markings on the envelopes and paper will be completely obliterated before they are used.

§ 101-44.108-8 [Reserved]

§ 101-44.108-9 Donation of vessels.

This section provides procedures and conditions for the transfer for donation

of any donable vessel which is 50 feet or more in length and has a unit acquisition cost of \$5,000 or more. Each SF 123 submitted to GSA for donation of a vessel which is 50 feet or more in length shall be accompanied by a letter of intent from the applicant donee setting forth in detail the proposed use of the vessel. Each donee, as a condition of the donation, shall agree also to fully comply with all Federal, State, and local laws, regulations, ordinances, and requirements, including, but not limited to those pertaining to environmental pollution, health and safety, and to obtain all necessary permits, licenses, certificates, and clearances applicable to acquiring, owning, transporting, repairing, using, operating, and maintaining the vessel. Each donee, as a condition of the donation, shall agree to obtain documentation of the vessel under the applicable laws of the United States and the several States, to maintain this documentation at all times, and to record each document with the U.S. Coast Guard at the port of documentation of the property within 30 calendar days after acquisition of the vessel, and in compliance with applicable Federal and State laws.

(a) *Plan of utilization.* To assist GSA in the allocation and transfer of available surplus vessels, each SF 123 submitted to GSA for donation of a vessel covered by this §101-44.108-9 shall include a letter of intent, signed and dated by the authorized representative of the proposed donee, setting forth a detailed plan of utilization for the property. The letter of intent shall provide the following information:

(1) A description of the vessel requested, including the type, name, class, size, displacement, length, beam, draft, lift capacity, and the hull or registry number, if it is known;

(2) A detailed description of the donee's program and the number and types of vessels currently owned by the donee;

(3) A detailed description of the planned utilization of the vessel including, but not limited to, how the vessel will be used, its purpose, how often and for how long and whether the vessel is to be operated on the waterways or not (including ground display,

permanent mooring or permanent land use). If for waterway purposes, a source of pilot(s) and where the vessel will be docked must be specified. When the vessel is requested for permanent docking on water or land, the letter of intent should provide details of the process including the time to complete the process.

(4) Any supplemental information (such as geographical area and population served, number of students enrolled in educational programs, number of visitors and students if for museum purposes, etc.) supporting the donee's need for the vessel.

(b) *Donation of vessels to public agencies and eligible nonprofit tax-exempt activities.* (1) For the donation of a vessel to a donee eligible in accordance with the provisions of subpart 101-44.2, the following documentation shall be submitted to GSA along with the SF 123 and the donee's letter of intent:

(i) A letter, signed and dated by the State agency director, confirming and certifying the applicant's eligibility and containing the State agency's evaluation of the applicant's ability to use the vessel for the purpose stated in its letter of intent and any other supplemental information concerning the needs of the donee which supports making the allocation;

(ii) A State agency distribution document, signed and dated by the authorized representative of the donee, and containing the terms, conditions, and restrictions prescribed by GSA; and

(iii) A conditional transfer document, signed by both the donee and the State agency, and containing the special terms, conditions, and restrictions prescribed by GSA in accordance with §101-44.108-9(b)(2). The conditional transfer document may include additional State agency imposed terms, conditions, and restrictions on the use of the vessel which are consistent with any Federal requirements or the State plan of operation. However, none of the Federal terms, conditions, and restrictions outlined in the executed conditional transfer document, including the requirement for an additional 48-month period of approved use, shall be modified, amended, waived, released, or abrogated by the State agency without the prior written approval of GSA.

Federal Property Management Regulations

§ 101-44.109

(2) Donation of vessels to public agencies and eligible nonprofit tax-exempt activities shall be subject to the following terms, conditions, and restrictions:

(i) The donee shall, within 30 calendar days of receipt of the vessel, apply for documentation of the vessel to the U.S. Coast Guard at the port of documentation of the vessel, under the applicable laws of the United States and regulations promulgated thereunder and the applicable laws of the several States governing the documentation of said property, and agrees to maintain at all times such documentation. The donee's application for documentation shall include a fully executed copy of the conditional transfer document and a copy of its letter of intent. The donee shall provide the State agency and GSA with evidence that the documentation is accomplished including a copy of all approved documentation.

(ii) The vessel shall be used solely in accordance with the executed conditional transfer document and the plan of utilization set forth in the donee's letter of intent, unless the donee has amended the letter and it has been approved in writing by the State agency and GSA and a copy of the amendment recorded with the U.S. Coast Guard at the port of documentation of the vessel.

(iii) Naval vessels of the following categories shall not be donated: Battleships, cruisers, aircraft carriers, destroyers and submarines (40 U.S.C. 472 (d)).

(iv) In the event any of the terms, conditions, and restrictions imposed by the conditional transfer document are breached, title and right to the possession of the vessel shall, at the option of GSA, revert to and become the property of the United States of America. The donee, at the option of GSA, shall be liable to the United States of America for the proceeds from any unauthorized disposal or for the fair market value or fair rental value of the vessel at the time of any unauthorized transaction or use, as determined by GSA.

(v) If, during the period of restriction, the vessel is no longer suitable, usable, or further needed by the donee for the purpose for which it was ac-

quired, the donee shall promptly notify the State agency and request disposal instructions. Disposal instructions shall not be issued by the State agency except with the prior written concurrence of GSA.

(c) *Donation of vessels to service educational activities.* (1) Donation of a surplus Department of Defense (DOD) vessel to a donee eligible in accordance with the provisions of subpart 101-44.4 shall be made in accordance with the terms of the individual donation agreement executed by DOD and the service educational activity and this §101-44.108-9. The SF 123, with the donee's letter of intent and any additional required documentation specified, shall be submitted for approval to the appropriate GSA regional office.

(2) The vessel shall be used solely in connection with the plan of utilization set forth in the donee's letter of intent unless DOD authorizes a change, in writing, to the donee's plan of utilization.

(3) The donee shall apply to the U.S. Coast Guard at the port for documentation of the vessel (and shall provide the U.S. Coast Guard with a copy of its letter of intent) within 30 calendar days of receipt of the vessel and shall forward a copy of evidence of the documentation to DOD and GSA.

[53 FR 16109, May 5, 1988]

§ 101-44.108-10 [Reserved]

§ 101-44.109 Donation screening period.

(a) A period of 21 calendar days following the surplus release date (see §101-43.001-32) shall be provided to set aside surplus reportable and nonreportable property determined to be usable and necessary for donation purposes in accordance with the provisions of subparts 101-44.2, 101-44.4, and 101-44.5. Reportable surplus property will be set aside for donation when an application for donation, with an informational copy to the holding activity, is submitted to a GSA regional office for approval within the donation screening period. Nonreportable surplus property will be set aside for donation upon notification to a holding activity within the donation screening period by a responsible Federal official, a State

§ 101-44.110

41 CFR Ch. 101 (7-1-01 Edition)

agency representative, or an authorized donee representative that the property is usable and necessary for donation purposes.

(b) During the prescribed 21-day donation screening period, applications for surplus personal property will be processed by GSA regional offices in the following sequence:

(1) Department of Defense personal property reportable to GSA in accordance with §101-43.304 will be reserved for public airport donation during the first 5 calendar days of the donation screening period and during the next 5 days for service educational activities. During the remaining portion of the donation screening period, the property will be available on a first-come, first-served basis to all applicants.

(2) Executive agency personal property, other than personal property of the Department of Defense, reportable to GSA in accordance with §101-43.304 will be reserved for public airport donation during the first 5 calendar days of the donation screening period. During the remaining portion of the donation screening period, the property will be available on a first-come, first-served basis. This property is not available for donation to service educational activities.

(3) All executive agency personal property not reportable to GSA will be made available for donation on a first-come, first-served basis. Service educational activities are not eligible for donation of nonreportable surplus personal property of executive agencies other than the Department of Defense.

(c) To expedite donation, surplus property may be made available on a case-by-case basis for onsite screening. The GSA regional office will contact the holding agency not later than 15 calendar days before the date the onsite screening is scheduled to start so that all necessary arrangements can be coordinated and agreed upon. If time will not permit separate utilization and donation screening, concurrent screening may be scheduled with Federal, State, and donee representatives in attendance. Participation in donation screening sessions is limited to State agency employees and representatives of eligible donees designated by the State agency to attend such ses-

sions. Screening sessions shall be conducted as follows:

(1) The donation screening period should be limited to the specific dates established by the agreement for the particular location. Generally, a screening period of 5 workdays should be sufficient.

(2) The property selected for the screening sessions should be set aside in separate areas and properly identified by the holding activity to facilitate screening sessions.

(3) GSA or State agency representatives should be present during all screening sessions.

(4) The State agency representatives shall prepare SF 123, Transfer Order Surplus Personal Property (illustrated at §101-44.4901-123), at the site on a daily basis for the property selected. Upon approval by the GSA representative, the holding activity shall release the property. Processing of donation documents shall be expedited to ensure that the property is removed at the end of each daily session to the maximum extent possible. Property shall not be released until the transfer is approved by the GSA representative, except in emergency situations as determined by GSA.

(5) When onsite screening is conducted on a continuing day-to-day basis under procedures previously agreed to in writing by GSA, the holding agency, and the State agency concerned, the presence of authorized GSA or State agency representatives is not required. Arrangements may provide for processing the essential donation documents after the onsite screening and removal of the property.

[53 FR 16110, May 5, 1988]

§ 101-44.110 Transfer orders for surplus personal property.

All transfers of surplus personal property to the State agencies for donation for authorized purposes to public agencies and eligible nonprofit tax-exempt activities, to service educational activities, and to public airports shall be accomplished by use of Standard Form (SF) 123, Transfer Order for Surplus Personal Property, and SF 123-A, Transfer Order-Surplus Personal Property (Continuation Sheet). The original and five copies of

Federal Property Management Regulations

§ 101-44.114

SF 123 shall be forwarded to the appropriate GSA regional office for approval, and an informational copy shall be sent to the holding activity.

[45 FR 56808, Aug. 26, 1980]

§ 101-44.111 Preparation and processing of transfer orders.

Applications for transfer shall be prepared and processed in accordance with the instructions illustrated at § 101-44.4901-123-1.

§ 101-44.112 Approval or disapproval of transfer orders.

(a) Surplus property shall not be released by a holding activity for donation until it has received an SF 123 bearing the signed approval of the appropriate GSA official. In approving the SF 123, GSA regional offices will comply with the sequence established in § 101-44.109. An SF 123 which is not fully or properly prepared may be returned to the applicant or held in suspense until the required information is made available. In those cases in which property is specifically requested for the purpose of cannibalization, the following statement shall be included on the SF 123: "Item(s) _____ requested for cannibalization." Cannibalization requests may be approved when it is clear that disassembly of the item for use of its component parts will provide greater potential benefit than use of the item in its existing form. Upon the request of a GSA regional office, the State agency (or the donee in the case of property donated under the provisions of subparts 101-44.4 or 101-44.5) shall submit any additional information required to support and justify a donation application. The SF 123 will not automatically be held to the end of the screening period, but will be approved and distributed as expeditiously as possible. An SF 123 received after the end of the donation screening period may be approved if the property is still available, and the holding activity has agreed to set the property aside pending receipt of donation approval.

(b) An SF 123 may be disapproved, in whole or in part, when it is determined that it is in the public interest to do so, when there is a substantive defect in the order, when the property is not surplus, or when a transfer of the prop-

erty to a Federal agency is pending. The applicant and the holding activity will be informed in writing why the SF 123 was disapproved. When a donation transfer is disapproved because of a pending Federal transfer and the transfer is not completed subsequently, the applicant will be advised to resubmit SF 123.

[42 FR 56003, Oct. 20, 1977, as amended at 53 FR 16111, May 5, 1988]

§ 101-44.113 Rejection of property approved for transfer.

When a State agency or donee determines prior to pickup or shipment that property approved for transfer cannot be utilized, it shall so notify, through appropriate channels, the GSA regional office which approved the transfer, and the property will be released by GSA for other disposal. The GSA regional office may advise any other State agency known to be interested in the property of its possible availability and may approve a transfer request for donation purposes provided the holding activity agrees to retain the property pending the approval.

§ 101-44.114 Pickup or shipment.

(a) Surplus property requested and set aside for donation will be retained by the holding agency for a maximum period of 42 calendar days from the surplus release date, pending receipt of the approved SF 123 and firm instructions for pickup or shipment of the property. At the end of this period, the holding activity may proceed with the sale or other authorized disposal of the property if the approved SF 123 and pickup or shipping instructions have not been received.

(b) Upon receipt of the approved SF 123 and instructions for pickup or shipment, the holding activity shall promptly notify the transferee or his designated agent of the availability of the property. The transferee or his agent shall remove the property within 15 calendar days from the date of notification of availability by the holding activity.

(c) The transferee is responsible for removing the property or for making arrangements with common carriers for its shipment. Property disposal officers or other representatives of holding

§ 101-44.115

activities shall not act as the agent or shipper for transferees in this regard.

[42 FR 56003, Oct. 20, 1977, as amended at 53 FR 16111, May 5, 1988]

§ 101-44.115 Overages and shortages.

(a) *Overages.* When a State agency, service educational activity (SEA), or public airport finds that it has received surplus property in excess of that listed on an approved SF 123, and the estimated fair market value or acquisition cost of the line items involved is less than \$500, it shall annotate its receiving and inventory records to document the overage. The annotation must include a description of the property, its estimated condition, the estimated fair market value (or acquisition cost if known), and the name of the holding activity from which the property was received. If property having an estimated fair market value or acquisition cost of \$500 or more is received, it shall be listed on an SF 123, and the SF 123 sent to the GSA regional office for approval. In the case of property received by a public airport, the SF 123 shall be forwarded to GSA through the Federal Aviation Administration (FAA).

(b) *Shortages.* When it is found that line items or portions of line items of property approved on an SF 123 were not received, and the total acquisition cost of the line items involved is less than \$300, the State agency, SEA, or public airport shall annotate its receiving and inventory records to document the shortage. The annotation must include a description of each line item of property, the acquisition cost, and the name of the holding activity. If the total acquisition cost is \$300 or more, a shortage report must be prepared and submitted to the GSA regional office for the region in which the holding activity is located. A copy of this report shall be sent to the holding activity. Shortage reports covering property approved for donation to a public airport should be forwarded to the GSA regional office through FAA.

(c) *Information.* Overages and shortages shall be reported, where required, within 90 calendar days of the date of transfer. The shortage report, or the SF 123 in the case of overages of \$500 or more, shall be signed by the responsible State agency or donee representa-

41 CFR Ch. 101 (7-1-01 Edition)

tive and shall provide the following information.

(1) Name and address of the holding activity;

(2) All pertinent control numbers including the holding activity turn-in document number, the GSA control number if property was reported to GSA, and the State agency or donee transfer order number; and

(3) A description of each line item of property, whether it is a shortage or an overage, the condition code (estimated if an overage), the quantity and unit of issue, and the unit and total acquisition cost (estimated if an overage).

[53 FR 16111, May 5, 1988]

§ 101-44.116 Certification of screeners.

(a) All State agency and donee representatives wishing to visit Federal activities for the purpose of screening and selecting surplus personal property for donation in accordance with subparts 101-44.2, 101-44.4, and 101-44.5 must be authorized and certified by GSA. Requests for certification of donee screeners shall be submitted to GSA by the appropriate State agency for the purposes of subpart 101-44.2 by the Department of Defense (DOD) for the purposes of subpart 101-44.4, and by the Federal Aviation Administration (FAA) for the purposes of subpart 101-44.5.

(b) The agency recommending the designation of a donee screener shall prepare a request to inform GSA of the proposed designation and forward it for evaluation and approval to the GSA regional office serving the region in which the intended screener is located. (See §101-43.4802 for regional offices, addresses, and assigned areas.) The request shall state the name and address of the State agency or donee activity the prospective screener represents, and certify that the applicant is qualified to screen as an authorized representative of the cited organization. A list of the Federal installations the screener will be authorized to visit shall accompany each request. The list of Federal installations should be limited to those within the applicable State, except where there are particular reasons why State agency screeners or donee screeners should regularly visit installations outside the

Federal Property Management Regulations

§ 101-44.118

State. Special requests for State agency or donee screeners to visit installations outside the State or region on a regular or one-time basis may be authorized by the GSA regional offices involved. The recommending agency shall select qualified screeners representing public agencies and other eligible donee organizations within the State in order to expedite the movement of surplus property and enhance the opportunities of those public agencies and organizations to identify and select needed and useful items of property. GSA will give special consideration to requests of individual donees submitted through recommending agencies for allocation of specific items of property.

(c) Recommending agencies shall accompany each request for certification of a donee screener with GSA Form 2946, Screener's Identification (illustrated at §101-43.4902-2946). GSA Forms 2946 must contain the typed names of the screener's organization and sponsoring agency, the signature and type name of the proposed screener, an affixed passport-style photograph of the screener, and the signature of the sponsoring agency official.

(d) In order to avoid proliferation of screeners, the GSA regional office will review requests for donee screening authorizations to ensure that the number of screeners requested by each designated activity is reasonable in relationship to the scope of the donee's program and that the screeners are qualified to perform this service. Following review, the GSA regional office, if the request is approved will complete the GSA Form 2946 and return it to the recommending agency for issuance to the screener. Each GSA regional office will control the activities of donee screeners at Federal installations within its region. The regional office may screeners' visits or require a reduction in their number when it becomes evident that the volume of surplus personal property at an installation does not warrant the level of screening activity or that a proliferation of screeners is affecting adversely the installa-

tion's property disposal activity. All GSA Forms 2946 shall be recovered by the recommending agency upon expiration or termination of the screener's authorization and shall be forwarded to the validating GSA office for cancellation.

(e) Each State agency or other donee representative physically screening property at holding installations for the purpose of selecting property for donation shall possess a GSA Form 2946 validated by GSA as provided in this §101-44.116. However, representatives visiting holding activities in order to participate in onsite screenings in accordance with §101-44.109, or for the purpose of technical inspection, evaluation, and/or removal of specific property previously set aside or approved by GSA for donation, shall not be required to possess a GSA Form 2946.

[42 FR 56003, Oct. 20, 1977, as amended at 53 FR 16112, May 5, 1988]

§ 101-44.117 Recovery of property for Federal use.

Occasionally, Federal agencies may develop on an exigency basis requirements for personal property items derived from surplus sources in the possession of a State agency. The State agency should cooperate with GSA in the recovery of property to fulfill Federal needs. The transfer will be subject to payment by the acquiring agency of the costs of care and handling, including transportation that were incurred by the State agency initially acquiring this property.

§ 101-44.118 Nondiscrimination.

All transfers of surplus property to the State agencies for donation to public agencies and eligible nonprofit tax-exempt activities, to service educational activities, and to public airports are conditioned on full compliance with GSA regulations on nondiscrimination as set forth in subpart 101-6.2 and part 101-8.

[53 FR 16112, May 5, 1988]

§ 101-44.119 [Reserved]

Subpart 101-44.2—Donations to Public Agencies and Eligible Nonprofit Tax-Exempt Activities

§ 101-44.200 Scope of subpart.

This subpart prescribes the authorities, responsibilities, policies and methods governing the donation of surplus personal property within the United States, the District of Columbia, the Commonwealth of Puerto Rico, the Virgin Islands, Guam, American Samoa, and the Commonwealth of the Northern Mariana Islands to eligible recipients as established in §101-44.207.

[53 FR 16112, May 5, 1988]

§ 101-44.201 Authority.

(a) Section 203(j)(1) of the Federal Property and Administrative Services Act of 1949, as amended (40 U.S.C. 484) (hereinafter called the act), gives the Administrator of General Services discretionary power to prescribe the necessary regulations for, and to execute, the surplus property donation program. This authority empowers the Administrator to transfer executive agency controlled surplus property to the agency of each State government designated under State law to be responsible for all property transferred in accordance with this subpart and subpart 101-44.4.

(b) The property which may be transferred for donation includes all personal property which has been determined to be donable as defined in §101-44.001-3.

[53 FR 16112, May 5, 1988]

§ 101-44.202 State agency plan of operation.

Section 203(j)(4) of the act provides that State agencies shall be established and operated in accordance with detailed plans developed according to State law and conforming with provisions of the act. A State must have its plan of operation approved by the Administrator before it may have property transferred to it. The plan must assure that the State agency has the necessary organizational and oper-

ational authority and capability, including staff, facilities, means and methods of financing, and procedures with respect to: Accountability, internal and external audits, cooperative agreements, compliance and utilization reviews, equitable distribution and property disposal, determination of eligibility, and assistance through consultation with advisory bodies and public and private groups.

(a) *State action.* The State plan of operation shall be developed by the State legislature, certified by the chief executive officer of the State, and submitted to the Administrator for acceptance.

(b) *General notice.* In accordance with the act no plan of operation and no major amendment thereof shall be filed with the Administrator until 60 calendar days after general notice of the proposed plan has been published, and interested persons have been given at least 30 calendar days during which to submit comments. In developing and implementing the plan the State shall take into consideration the relative needs and resources of all public agencies and other eligible institutions within the State. Assurance shall be provided in the State plan that such public notice and such time for public comment was provided prior to submission of the plan and that such consideration of relative needs and resources of all donees in the State was given in the preparation of the plan.

(c) *Specific assurances.* A State plan for the establishment and operation of a State agency for surplus property distribution to eligible donees shall provide the following information and assurances. (A State may include in its plan other provisions not inconsistent with the purposes of the act and the requirements of this part 101-44):

(1) *Authority.* The chief executive officer of the State shall submit the State plan of operation to the Administrator as follows:

(i) The chief executive officer shall submit the plan and certify that the State agency is authorized thereby to acquire, warehouse, and distribute surplus property to all eligible donees in the State, to enter into cooperative agreements pursuant to the provisions of §101-44.206, and to undertake other

actions and provide other assurances as are set forth in the plan of operation; and

(ii) Copies of existing State statutes and/or executive orders relative to the operational authority of the State agency shall accompany the State plan. Where express statutory authority does not exist or is ambiguous, or where authority exists by virtue of executive order, the State plan shall include also the opinion of the State's Attorney General regarding the existence of such authority.

(2) *Designation of State agency.* The plan shall designate a State agency which will be responsible for administering the plan throughout the State. The plan shall describe the responsibilities vested in the agency and shall provide details concerning the organization of the agency, including supervision, staffing, structure, and physical facilities. The plan shall also indicate the organizational status of the agency within the State governmental structure and the title of the State official who directly supervises the State agent.

(3) *Inventory control and accounting systems.* The State plan shall require the State agency to use a management control and accounting system that will effectively govern the utilization, inventory control, accountability, and disposal of donable surplus property. The plan shall set forth the details of the inventory control and accounting system which will be used by the State agency.

(4) *Return of donated property.* The State plan shall require and set forth procedures for donees to return donable property to the State agency if such property while still usable, as determined by the State agency, has not been placed in use for the purposes for which it was donated within 1 year of donation or ceases to be used by the donee for such purposes within 1 year of being placed in use.

(5) *Financing and service charges.* The State plan shall set forth the means and methods by which the State agency will be financed. When the State agency is authorized to assess and collect service charges from participating donees to cover direct and reasonable indirect costs of its activities, the

method of establishing the charges shall be set forth in the plan. The charges shall be fair and equitable and based on services performed by the State agency, including but not limited to screening, packing, crating, removal, and transportation. When the State agency provides minimal services in connection with the acquisition of property, except for document processing and other administrative actions, the charge levied by the State agency shall be minimal. The State plan shall provide for minimal charges to be assessed in such cases and include the bases of computation. When property is made available to nonprofit providers of assistance to homeless individuals, the State plan shall provide for this property to be distributed at a nominal cost for care and handling of the property. The plan of operation shall set forth how funds accumulated from service charges, or from other sources such as sales or compliance proceeds, are to be used for the operation of the State agency and the benefit of participating donees. Service charge funds may be used to cover direct and indirect costs of the State agency's operation, to purchase necessary equipment, and to maintain a reasonable working capital reserve. Such funds may be deposited or invested as permitted by State law, provided the plan of operation sets forth the types of depositories and/or investments contemplated. Service charge funds may be used for rehabilitating donable surplus property, including the purchase of replacement parts. Subject to State authority and the plan of operation, the State agency may expend service charge funds to acquire or improve office or distribution center facilities. When such acquisition or improvements are contemplated, the plan shall set forth what disposition is to be made of any financial assets realized upon the sale or other disposal of the facilities. When refunds of service charges in excess of the State agency's working capital reserve are to be made to participating donees, the plan shall so state and provide details of how such refunds are to be made, such as a reduction in service charges or a cash refund, prorated in an equitable manner.

(6) *Terms and conditions on donable property.* The State plan shall require the State agency to impose terms, conditions, reservations, and restrictions on the donee in the case of any item of property having a unit acquisition cost of \$5,000 or more and any passenger motor vehicle. The specific terms, conditions, reservations, and restrictions which the State agency requires shall be set forth in the plan. In addition, the State plan shall provide that the State agency may impose reasonable terms, conditions, reservations, and restrictions on the use of donable property other than items with a unit acquisition cost of \$5,000 or more and passenger motor vehicles. Any such additional terms, conditions, reservations, and restrictions which the State agency elects to impose should be set forth in the plan. The State agency may amend, modify, or release such terms, conditions, reservations, or restrictions subject to the provisions of § 101-44.208(g), provided it sets forth in the plan the standards by which the State agency will grant any such amendments, modifications or releases. The State plan also shall provide assurance that the State agency will impose on the donation of a surplus item or items, regardless of unit acquisition cost, such conditions involving special handling or use limitations as the Administrator may determine necessary because of the characteristics of the property, pursuant to § 101-44.108.

(7) *Nonutilized donable property.* The State plan shall provide that donable surplus property in the possession of the State agency which cannot be utilized by donees in the State shall be disposed of:

(i) Subject to the disapproval of the Administrator within 30 days after notice to him, through transfer by the State agency to another State agency or through abandonment or destruction where the property has no commercial value or the estimated cost of its continued care and handling would exceed the estimated proceeds from sale (Transfers of nonutilized donable property and destruction or abandonment shall be accomplished by the State agency in accordance with the provisions of § 101-44.205); or

(ii) Otherwise, under such terms and conditions and in such a manner as may be prescribed by the Administrator pursuant to the provisions of § 101-44.205.

(8) *Fair and equitable distribution.* The State agency is responsible for the fair and equitable distribution of surplus personal property through donation to all eligible donees in the State. The State plan shall provide for distribution based on the relative needs and resources of public agencies and other eligible institutions and their abilities to utilize the property. The State plan shall set forth the policies and detailed procedures for effecting a prompt, fair, and equitable distribution. The State plan shall also require that the State agency, insofar as practicable, select property requested by a public agency or other eligible institution and, when so requested by the recipient, arrange for shipment of the property direct to the recipient.

(9) *Eligibility.* The State plan shall set forth procedures for the State agency to determine the eligibility of applicants for the donation of surplus personal property. Standard and guidelines for the determination of eligibility are provided in § 101-44.207.

(10) *Compliance and utilization.* The State agency shall effect utilization reviews for compliance by donees with the terms, conditions, reservations, and restrictions imposed by the State agency for any item of property having a unit acquisition cost of \$5,000 or more and any passenger motor vehicle. Such reviews also shall include a review of compliance by the donees with any special handling conditions or use limitations imposed on items of property by the Administrator, pursuant to § 101-44.108. The State plan shall set forth the provisions for and the proposed frequency of such reviews and shall provide adequate assurances that effective action shall be taken by the State agency to correct noncompliance or otherwise enforce such terms, conditions, reservations, and restrictions. Reports on utilization reviews and compliance actions shall be prepared by the State agency. The State plan shall provide adequate assurance that the State agency shall initiate appropriate investigations of alleged fraud

Federal Property Management Regulations

§ 101-44.202

in the acquisition of donated property or misuse of such property. The State agency shall immediately notify the Federal Bureau of Investigation (FBI) and GSA of any case involving alleged fraud. Further, GSA shall be advised of any misuse of donated property. The State agency shall assist GSA or other responsible Federal or State agencies in investigating such cases upon request.

(11) *Consultation with advisory bodies and public and private groups.* The State plan shall provide for consultation by the State agency with advisory bodies and public and private groups which can assist the State agency in determining the relative needs and resources of donees, the proposed utilization of donable property by eligible donees, and how distribution of donable property can be effected to fill existing needs of donees. Details of how the State agency will accomplish such consultation shall be set forth in the plan.

(12) *Audit.* The State plan shall provide for periodic internal audits of the operations and financial affairs of the State agency and compliance with the external audit requirements of Office of Management and Budget Circular No. A-128 "Audits of State and Local Governments." The State agency must provide the appropriate GSA regional office with two copies of any audit report made pursuant to the Circular, or with copies of those sections that pertain to the Federal donation program. An outline of the corrective actions which the State agency will take to comply with any exceptions or violations indicated by the audit, and the scheduled completion dates for these actions, must be submitted with the audit report. Periodically, GSA representatives may visit the State agency to coordinate program activities and review the State agency operations. GSA may, for appropriate reasons, conduct its own audit of the State agency following due notice to the chief executive officer of the State of the reasons for such audit. Financial records and all other books and records of the State agency shall be made available for inspection by representatives of GSA, the General Accounting Office, or other authorized Federal activities.

(13) *Cooperative agreements.* Section 203(n) of the act authorizes the Administrator (or the head of any Federal agency designated by him) to enter into cooperative agreements with State surplus property distribution agencies. The provisions of section 203(n) and the implementing regulations are set forth in §101-44.206. A State agency desiring to enter into such cooperative agreements or to renew or revise existing agreements shall affirm its intentions in the State plan and cite the authority called for in §101-44.202(c)(1).

(14) *Liquidation.* The State plan shall provide for the submission of a liquidation plan to the Administrator when a determination is made to liquidate the State agency. The liquidation plan shall be submitted before the actual termination of the State agency activities and shall include:

(i) Reasons for the liquidation;

(ii) A schedule for liquidating the agency and the estimated date of termination;

(iii) Method of disposing of surplus property on hand, consistent with the provisions of §101-44.205;

(iv) Method of disposing of the agency's physical and financial assets;

(v) Retention of all available books and records of the State agency for a 2-year period following liquidation; and

(vi) Designation of another governmental entity to serve as the agency's successor in function until continuing obligations on property donated prior to the closing of the agency are fulfilled.

(15) *Forms.* Copies of distribution documents used by the State agency shall be included in the State plan.

(16) *Records.* The State plan shall provide for the retention of official records of the State agency for a period of not less than 3 years, provided that in cases involving property subject to restrictions for more than 2 years, records shall be kept 1 year beyond the specified period of restriction. In cases in which property is in compliance status at the end of the period of restriction, the State plan shall provide for the retention of the records for at least 1 year after the case is closed.

§ 101-44.203

(d) *Implementation.* (1) A State plan of operation developed by the State legislature and certified by the chief executive officer of the State shall be in effect and binding upon the State beginning with the date that the Administrator notifies the chief executive officer of the State that the plan conforms to the provisions of section 203(j)(4) of the act and the requirements of this part 101-44 and that allocation and transfer of donable surplus property to the State agency will commence. Such plan of operation shall remain in effect until such time as the Administrator may accept revisions.

(2) GSA may, from time to time, propose modifications or amendments to the provisions of this part 101-44. In such cases, reasonable opportunity will, insofar as practicable, be afforded the State agencies to conform to any such regulatory changes affecting their operations.

(e) *Nonconformance.* When the Administrator determines that a State plan does not conform to the requirements of the act or the provisions of this part 101-44, or subsequently that the State agency does not operate in accordance with the provisions of the plan, allocation and transfer of surplus donable property may be withheld until the nonconformance is corrected.

[42 FR 56003, Oct. 20, 1977; 42 FR 61043, Dec. 1, 1977, as amended at 53 FR 11612, May 5, 1988; 53 FR 47197, Nov. 22, 1988]

§ 101-44.203 Allocation of donable property.

Allocation of donable property will be made by GSA on a fair and equitable basis. The following criteria will be applied by GSA in effecting allocation and transfer of surplus personal property among the States:

(a) Need and usability of property as reflected in selections of property by a State agency, including expressions of need and interest on the part of public agencies or other eligible donees within the State, transmitted through the State agency to GSA. Special consideration will be given by GSA to requests transmitted through the State agency by eligible donees for specific items of property.

41 CFR Ch. 101 (7-1-01 Edition)

(b) Regions or States in greatest need of the type of property to be allocated, where a particular and important need is evidenced by a justification accompanying the expression of need.

(c) Extraordinary needs occasioned by disasters.

(d) The quantity of property of the type under consideration which was previously allocated to or is potentially available to a State agency from a more advantageous source.

(e) Performance of a State agency in effecting timely pickup or removal of property allocated to the State and approved for transfer by GSA.

(f) Performance of a State agency in effecting prompt distribution of property to eligible donees.

(g) Equitable distribution based on the existing condition as well as the original acquisition cost of the property available for donation.

(h) Equitable distribution based on the ratio of population and per capita income of each State.

§ 101-44.204 Certification and agreement by a State agency.

(a) *Certification.* A State agency, in making a request to GSA for the transfer of donable surplus personal property, shall certify that:

(1) It is the agency of the State designated under State law, and as such has legal authority within the meaning of section 203(j) of the act and GSA regulations, to receive surplus property for distribution within the State to eligible donees within the meaning of the act and GSA regulation;

(2) The property is usable and needed by a public agency for one or more public purposes, such as conservation, economic development, education, parks and recreation, public health, public safety, and programs for older individuals, by an eligible nonprofit organization or institution which is exempt from taxation in the State under section 501 of the Internal Revenue Code of 1954, for the purpose of education or public health (including research for any such purpose) or by an eligible nonprofit tax-exempt activity for programs for older individuals;

Federal Property Management Regulations

§ 101-44.205

(3) When property is picked up by or shipped to a State agency, it has available adequate funds, facilities, and personnel to effect accountability, warehousing, proper maintenance, and distribution of the property; and

(4) When property is distributed by a State agency to a donee, or when delivery is made direct from a holding activity to a donee, the donee acquiring the property is eligible within the meaning of the act and GSA regulations, and that the property is usable and needed by the donee.

(b) *Agreement.* With respect to donable property picked up by or shipped to a State agency, the State agency shall agree to the following:

(1) The right to possession only is granted and the State agency will make prompt statewide distribution of the same, on a fair and equitable basis, to donees eligible to acquire property under section 203(j) of the act and GSA regulations, after such eligible donees have properly executed the appropriate certifications and agreements established by the State agency and/or GSA.

(2) Title to the property shall remain in the United States of America although the State shall have taken possession thereof. Conditional title to the property shall pass to the eligible donee when the donee executes the certifications and appropriate agreements required by the State agency and has taken possession of the property.

(3) The State agency shall:

(i) Pay promptly the cost of care, handling, and shipping incident to taking possession of the property;

(ii) During the time that title remains in the United States of America, be responsible as a bailee for mutual benefit for the property from the time it is released to the State agency or to the transportation agent designated by the State agency; and

(iii) In the event of any loss of or damage to any or all of the property, file a claim and/or institute and prosecute to conclusion the proceedings necessary to recover for the account of the United States of America the fair market value of any of the property lost or damaged.

(4) Surplus property hereafter approved for transfer by GSA for donation shall not be retained by the State

agency for use in performing its functions unless the use of such property is authorized by GSA in accordance with the provisions of a cooperative agreement entered into between the State agency and GSA.

(c) *Interstate distribution.* Where an applicant State agency is acting under an interstate distribution agreement approved by GSA as an agent and authorized representative of an adjacent State with which it shares a common boundary the certifications and agreements required above shall also be made by the applicant State agency respecting the donees in the adjacent State to which distribution will be made and the property to be distributed in the adjacent State, and these certifications and agreements shall constitute the certifications and agreements of the adjacent State on whose behalf and as whose authorized representative the applicant State agency is acting.

[42 FR 56003, Oct. 20, 1977, as amended at 45 FR 56809, Aug. 26, 1980; 53 FR 16114, May 5, 1988]

§ 101-44.205 Property in the possession of a State agency.

(a) *Status.* Title to all donable property located in a State agency distribution center is vested in the United States of America. The right to possession only is granted to the State agency. The State agency may disassemble or cannibalize an item of donable property in its possession when it determines that the usable parts and components thereof have greater donation potential than that for which the complete item was originally manufactured. The State agency may retain and use surplus personal property in its possession for the purpose of performing its functions pursuant to the provisions of § 101-44.206.

(b) *Protection.* During the time title remains in the United States of America the State agency shall:

(1) Be responsible as a bailee for mutual benefit for surplus personal property transferred to it by GSA from the time it is released to the State or to the transportation agent designated by the State, and in the event of any loss of or damage to any or all of the property, the State agency shall promptly

notify GSA and file a claim and/or institute and prosecute to conclusion the proceedings that are necessary to recover, for the account of the United States of America, the fair market value of any property lost or damaged, less the cost of care and handling incurred by the State agency in acquiring the property;

(2) Maintain adequate provision for protecting property in its custody including protection against the hazards of fire, theft, vandalism, and weather; and

(3) Promptly notify appropriate law officials including the FBI and GSA of any damage to or loss of property in its custody due to theft, vandalism, arson, or other unusual circumstances and shall provide full information concerning the circumstances. GSA shall be informed of any other types of damages to or loss of property which is in the possession of the State agency.

(c) *Insurance.* It is GSA policy not to require a State agency to carry insurance as a condition for acquiring Federal surplus personal property for distribution to eligible recipients. However, when a State agency carries insurance against damage to or loss of property due to fire or other hazards and when loss of or damage to Federal surplus personal property occurs, GSA, on behalf of the United States of America, will be entitled to reimbursement from the State agency of the fair market value of the damaged or destroyed Federal property payable from the insurance proceeds, less the State agency's actual cost of acquiring and rehabilitating the property prior to its damage or destruction.

(d) *Distribution.* Surplus personal property in the custody of a State agency shall be distributed promptly to eligible donees within the State.

(e) *Direct shipment.* In order to reduce inventory, warehousing, and transportation costs and to ensure prompt utilization of donable surplus property, the State agency shall, insofar as practicable, when requested by the designated donee, arrange for or provide shipment of the property from the Federal holding agency direct to the recipient.

(f) *Transfer between States.* When a State agency determines that surplus

personal property in its possession cannot be utilized by eligible recipients within the State, it shall offer the property for transfer to surplus property agencies in other States. GSA encourages prompt transfer of property between the States. A State agency may arrange for visits to its distribution facilities by representatives of other State surplus property agencies to inspect and select unneeded property available for transfer. GSA regional offices, upon request, will assist in making known to other States unneeded property in one State which is available for transfer and in arranging and coordinating visits between State agencies. Transfers of property between States will be accomplished by processing SF 123, Transfer Order Surplus Personal Property, submitted by the requesting State through the GSA regional office for the releasing State. Transfers of unneeded surplus property between State agencies are subject to the disapproval of the Administrator within 30 days after notice to him.

(g) *Reporting unneeded property.* A State agency at any time may report unneeded usable property in its possession which is not required for transfer to another State in the GSA regional office for redistribution or disposal. In reporting property to GSA, the State agency shall:

(1) Provide the best possible description of each line item of property and its current condition code, quantity, and unit total acquisition cost;

(2) Identify the date of receipt by the State agency of each line item of property listed;

(3) Indicate those items which the State agency believes may be of interest to Federal agencies; and

(4) Provide certification of reimbursement claimed for each line item.

(h) *Reutilization.* Based on the information provided by the State agency, the GSA regional office may offer available property for recovery by Federal agencies. Any transfer order for that property will be approved by GSA and forwarded to the releasing State agency for appropriate action.

(i) *Disposal.* Sale of undistributed property in the possession of a State agency will be initiated by the GSA regional office in accordance with the

provisions of part 101-45. The GSA regional office will inform the State agency of the items to be sold and will work closely with the State agency in the preparation and prompt completion of the sale. Property available for sale may be turned in by a State agency to a GSA property or sales center with the approval of the GSA regional office which operates the center.

(j) *Reimbursement.* Reimbursement for costs of care and handling to a State agency with respect to the transfer or disposal of donable property in its possession will be authorized by GSA as follows:

(1) When a State agency acquires donable property by transfer from another State agency, reimbursement of costs incurred by the releasing State agency in acquiring the property, including packing, handling, and transportation costs, shall be established by mutual agreement between the two State agencies.

(2) When a Federal activity requests property from a State agency, costs incurred by the State agency in acquiring the property, including packing, handling, and transportation costs, shall be reimbursable at the time the property is transferred to the Federal activity. The SF 122 used in effecting the transfer must show the amount of reimbursement claimed by the releasing State agency.

(3) When donable property in the possession of a State agency is required for disaster assistance, reimbursement to the State agency will be governed by the provisions of §101-44.105.

(4) When disposing of undistributed property in the possession of a State agency by public sale, GSA may authorize reimbursement to the State agency for expenses related to care and handling incurred by the State agency in acquiring the property from within or outside the United States. Certification by the State agency of costs incurred is required and must be supported by documentation if requested by GSA. Reimbursement must not exceed the proceeds from the sale of the property. No reimbursement may be made to the State agency for actions subsequent to the receipt of property by the State agency from any source, including unloading, moving, repair-

ing, preserving, or storing. Reimbursement will not be authorized by GSA for property acquired from any source if the property has been in the possession of the State agency for a period of 2 years from the date it was received by the State agency until the date it was reported to GSA for disposal. Costs of transporting property to a location outside a State agency distribution facility are not reimbursable unless transportation was specifically required by GSA. The sale of property at a location outside the State distribution facility, however, does not preclude authorized reimbursement to the State agency. Reimbursement is limited to:

(i) Direct costs incurred by the Federal holding agency and billed to and paid by the State agency, including but not limited to packing, preparation for shipment, and loading; and

(ii) Transportation costs paid or otherwise incurred by the State agency and not reimbursed by a donee to the State agency for initially moving the property from the Federal holding agency to the State agency distribution facility or other point of receipt designated by the State agency.

(k) *Abandonment or destruction.* When a GSA regional office finds that a State agency has property in its possession that is unusable, the State agency may be instructed to proceed promptly with the abandonment or destruction of such property in accordance with the findings and the processes prescribed in subpart 101-45.9.

[42 FR 56003, Oct. 20, 1977, as amended at 53 FR 16114, May 5, 1988]

§ 101-44.206 Cooperative agreements.

This section provides policies and procedures for the establishment of cooperative agreements between GSA (or the head of any Federal agency designated by the Administrator of General Services) and a State agency for the use of property, facilities, personnel, and services, with or without payment or reimbursement and under the provisions of a cooperative agreement, for the use by the State agency of any surplus personal property in its possession subject to conditions imposed by the Administrator.

(a) *Authority.* Section 203(n) of the Federal Property and Administrative Services Act of 1949, as amended, provides that the Administrator (or the head of any Federal agency designated by him), for the purpose of carrying into effect the provisions of section 203(j) of the act, is authorized to enter into cooperative agreements with State surplus property distribution agencies designated in conformity with that section.

(b) *Use of property, facilities, personnel, and services.* (1) GSA may enter into a cooperative agreement with a State agency to furnish to the State agency available property, facilities, personnel, or services of GSA that are found by GSA and the State agency to be necessary and useful in assisting the State agency to distribute and use surplus donable personal property and otherwise to carry out the purposes of the act. Assistance may include furnishing Federal Telecommunications System (FTS) service on a reimbursable basis. It may also include furnishing available office space and related support such as office furniture and typewriters in GSA regional offices, property centers, or field offices to State agency screeners or administrative clerical employees to assist them in screening and processing donable property for donation. Assistance will be provided by GSA, to the extent possible, without reimbursement; however, any extraordinary costs incurred by GSA in providing assistance shall be on a reimbursable basis.

(2) GSA may enter into a cooperative agreement with a State agency for the purpose of the State agency furnishing available property, facilities, personnel, or services that are found by GSA and the State agency to be necessary and useful in assisting GSA to screen, transfer, and allocate surplus donable personal property and otherwise to carry out the purposes of the act. The provision of property, facilities, personnel, or services may be with or without payment or reimbursement to the State agency.

(3) When a Federal agency designated by GSA wishes to enter into a cooperative agreement with a State agency (or a State agency with a Federal agency) for the provision of property, facilities,

personnel, or services to carry into effect the donation provisions of the act, and the Federal agency and the State agency are mutually agreeable to an arrangement, GSA may concur in the establishment of a cooperative agreement and assist in its development. Payment or reimbursement shall be a matter for resolution between the Federal agency and the State agency.

(c) *Use of surplus property by a State agency.* A State agency may enter into a cooperative agreement with GSA providing for the retention by the State agency of items of surplus personal property transferred to it for distribution that are needed for the State agency in performing its donation functions. The State agency shall submit a listing of needed property from time to time to the appropriate GSA regional office. GSA will review the list to ensure that it is of the type and quantity of property which is reasonably needed and useful to the State agency in performing its function. Unless GSA disapproves the retention of the property within 30 days of receipt of the listing, title to the property shall vest in the State agency. Separate records shall be maintained by the State agency for the property.

(d) *Interstate cooperative distribution agreements.* GSA may concur in a cooperative agreement between two States which have contiguous boundaries whereby one State agency agrees to distribute donable surplus property to certain specified donees in the adjoining State. Agreements may be considered when the donees, because of their geographic proximity to the property distribution centers of the adjoining State, could be more efficiently and economically serviced than by their own State surplus property facilities. The payment or reimbursement of service charges by the donee shall be a matter for the mutual agreement between the State agencies. By entering into an interstate cooperative distribution agreement, the State agreeing to service donees in an adjoining State shall agree, as agent for the adjoining State agency, to:

- (1) Make certifications and agreements required by §101-44.204; and
- (2) Require the donee to execute the distribution of documents of the State

agency in which the donee is located. Copies of distribution documents shall be forwarded to the adjoining State agency.

(e) *Termination of agreements.* Cooperative agreements entered into between GSA and a State agency may be terminated by either party upon 60 days written notice to the other party. Termination of an agreement between a Federal agency designated by GSA and a State agency, and interstate cooperative distribution agreements, shall be as mutually agreed to by the parties.

[42 FR 56003, Oct. 20, 1977, as amended at 53 FR 16115, May 5, 1988]

§ 101-44.207 Eligibility.

This section sets forth the standards, guidelines, and procedures for determination of eligibility for public agencies and eligible nonprofit tax-exempt activities in each State to participate in the surplus personal property donation program, to receive surplus property through a State agency, and to use this property for the purposes authorized by the Federal Property and Administrative Services Act of 1949, as amended, and by section 213 of the Older Americans Act of 1965, as amended (42 U.S.C. 3020d).

(a) *Definitions.* For the purposes of this section, the following terms shall have the meanings set forth in this section:

(1) *Accredited* means approval by a recognized accrediting board or association on a regional, State, or national level, such as a State board of education or health; the American Hospital Association; a regional or national accrediting association for universities, colleges, or secondary schools; or another recognized accrediting association.

(2) *Approved* means recognition and approval by the State department of education, State department of health, or other appropriate authority where no recognized accrediting board, association, or other authority exists for the purpose of making an accreditation. For an educational institution or an educational program, approval must relate to academic or instructional standards established by the appropriate authority. An educational institution or program may be considered

approved if its instruction and credits therefor are accepted by three accredited or State-approved institutions, or if it meets the academic or instructional standards prescribed for public schools in the State; i.e., the organizational entity or program is devoted primarily to approved academic, vocational (including technical or occupational), or professional study and instruction, which operates primarily for educational purposes on a full-time basis for a minimum school year as prescribed by the State and employs a full-time staff of qualified instructors. For a public health institution or program, approval must relate to the medical requirements and standards for the professional and technical services of the institution established by the appropriate authority. A health institution or program may be considered as approved when a State body having authority under law to establish standards and requirements for public health institutions renders approval thereto whether by accreditation procedures or by licensing or such other method prescribed by State law. In the absence of an official State approving authority for a public health institution or program or educational institution or program, the awarding of research grants to the institution or organization by a recognized authority such as the National Institutes of Health, the National Institute of Education, or by similar national advisory council or organization may constitute approval of the institution or program provided all other criteria are met.

(3) *Child care center* means a public or nonprofit facility where educational, social, health, and nutritional services are provided to children through age 14 or as prescribed by State law, and which is approved or licensed by the State or other appropriate authority as a child day care center or child care center.

(4) *Clinic* means an approved public or nonprofit facility organized and operated for the primary purpose of providing outpatient public health services and includes customary related services such as laboratories and treatment rooms.

(5) *College* means an approved or accredited public or nonprofit institution

of higher learning offering organized study courses and credits leading to a baccalaureate of higher degree.

(6) *Conservation* means a program or programs carried out or promoted by a public agency for public purposes involving directly or indirectly the protection, maintenance, development, and restoration of the natural resources of a given political area. These resources include but are not limited to the air; land; forests; water; rivers; streams; lakes and ponds; minerals; and animals, fish and other wildlife.

(7) *Economic development* means a program or programs carried out or promoted by a public agency for public purposes which involve directly or indirectly efforts to improve the opportunities of a given political area for the successful establishment or expansion of industrial, commercial, or agricultural plants or facilities and which otherwise assist in the creation of long-term employment opportunities in the area or primarily benefit the unemployed or those with low incomes.

(8) *Education* means a program or programs to develop and promote the training, general knowledge, or academic, technical, and vocational skills and cultural attainments of individuals in a community or other given political area. These programs may be conducted by schools, including preschool activities and child care centers, colleges, universities, schools for the mentally retarded or physically handicapped, educational radio and television stations, libraries, or museums. Public educational programs may include public school systems and supporting facilities such as centralized administrative or service facilities.

(9) *Educational institution* means an approved, accredited, or licensed public or nonprofit institution, facility, entity, or organization conducting educational programs, including research for any such programs, such as a child care center, school, college, university, school for the mentally retarded, school for the physically handicapped, or an educational radio or television station.

(10) *Educational radio station* means a radio station licensed by the Federal Communications Commission and operated exclusively for noncommercial

educational purposes and which is public or nonprofit and tax exempt under section 501 of the Internal Revenue Code of 1954.

(11) *Educational television station* means a television station licensed by the Federal Communications Commission and operated exclusively for non-commercial educational purposes and which is public or nonprofit and tax exempt under section 501 of the Internal Revenue Code of 1954.

(12) *Health center* means an approved public or nonprofit facility utilized by a health unit for the provision of public health services, including related facilities such as diagnostic and laboratory facilities and clinics.

(12.1) *Homeless individual* means an individual who lacks a fixed, regular, and adequate nighttime residence, or who has a primary nighttime residence that is: (i) A supervised publicly or privately operated shelter designed to provide temporary living accommodations (including welfare hotels, congregate shelters, and transitional housing for the mentally ill); (ii) an institution that provides a temporary residence for individuals intended to be institutionalized; or (iii) a public or private place not designed for, or ordinarily used as, a regular sleeping accommodation for human beings. For purposes of this regulation, the term does not include any individual imprisoned or otherwise detained pursuant to an Act of the Congress or a State law.

(13) *Hospital* means an approved or accredited public or nonprofit institution providing public health services primarily for inpatient medical or surgical care of the sick and injured and includes related facilities such as laboratories, outpatient departments, training facilities, and staff offices.

(14) *Library* means a public or nonprofit facility providing library services free to all residents of a community, district, State, or region.

(14.1) *Licensed* means recognition and approval by the appropriate State or local authority approving institutions or programs in specialized areas. Licensing generally relates to established minimum public standards of safety, sanitation, staffing, and equipment as they relate to the construction, maintenance, and operation of a health or

educational facility, rather than to the academic, instructional, or medical standards for these institutions. Licensing may be required for educational or public health programs such as occupational training, physical or mental health rehabilitation services, or nursing care. Licenses frequently must be renewed at periodic intervals.

(15) *Medical institution* means an approved, accredited, or licensed public or nonprofit institution, facility, entity, or organization the primary function of which is the furnishing of public health and medical services to the public at large or promoting public health through the conduct of research for any such purposes, experiments, training, or demonstrations related to cause, prevention, and methods of diagnosis and treatment of diseases and injuries. The term includes but is not limited to hospitals, clinics, alcohol and drug abuse treatment centers, public health or treatment centers, research and health centers, geriatric centers, laboratories, medical schools, dental schools, nursing schools, and similar institutions. The term does not include institutions primarily engaged in domiciliary care although a separate medical facility within such a domiciliary institution may qualify as a "medical institution."

(16) *Museum* means a public or private nonprofit institution which is organized on a permanent basis essentially for educational or esthetic purposes and which, using a professional staff, owns or uses tangible objects, whether animate or inanimate; cares for these objects; and exhibits them to the public on a regular basis either free or at a nominal charge. As used in this section, the term "museum" includes, but is not limited to, the following institutions if they satisfy all other provisions of this section: Aquariums and zoological parks; botanical gardens and arboretums; museums relating to art, history, natural history, science, and technology; and planetariums. For the purposes of this section, an institution uses a professional staff if it employs full time at least one qualified staff member who devotes his or her time primarily to the acquisition, care, or public exhibition of objects owned or

used by the institution. This definition of museum does not include any institution which exhibits objects to the public if the display or use of the objects is only incidental to the primary function of the institution. For example, an institution which is engaged primarily in the sale of antiques, objets d'art, or other artifacts and which incidentally provides displays to the public of animate or inanimate objects, either free or at a nominal charge, does not qualify as a museum.

(17) *Nonprofit tax-exempt activity* means an institution or organization, no part of the net earnings of which inures or may lawfully inure to the benefit of any private shareholder or individual, and which has been held to be tax-exempt under the provisions of section 501 of the Internal Revenue Code of 1954.

(18) *Park and recreation* means a program or programs carried out or promoted by a public agency for public purposes which involve directly or indirectly the acquisition, development, improvement, maintenance, and protection of park and recreational facilities for the residents of a given political area. These facilities include but are not limited to parks, playgrounds and athletic fields, swimming pools, golf courses, nature facilities, and nature trails.

(18.1) *Provider of assistance to homeless individuals* means a public agency or a nonprofit, tax-exempt institution or organization that operates a program which provides assistance such as food, shelter, or other services to homeless individuals, as defined in paragraph (a)(12.1) of this section. Property acquired through the donation program by such institutions or organizations must be used primarily for the program(s) operated to assist homeless individuals.

(19) *Public health* means a program or programs to promote, maintain, and conserve the public's health by providing health services to individuals and/or by conducting research, investigations, examinations, training, and demonstrations. Public health services may include but are not limited to the control of communicable diseases, immunization, maternal and child health programs, sanitary engineering, sewage

treatment and disposal, sanitation inspection and supervision, water purification and distribution, air pollution control, garbage and trash disposal, and the control and elimination of disease-carrying animals and insects.

(20) *Public health institution* means an approved, accredited, or licensed public or nonprofit institution, facility, entity, or organization conducting a public health program or programs such as a hospital, clinic, health center, or medical institution, including research for any such program, the services of which are available to the public at large.

(21) *Public safety* means a program or programs carried out or promoted by a public agency for public purposes involving, directly or indirectly, the protection, safety, law enforcement activities, and criminal justice system of a given political area. Public safety programs may include but are not limited to those carried out by public police departments, sheriffs' offices, the courts, penal and correctional institutions and including juvenile facilities, State and civil defense organizations, and fire departments and rescue squads including volunteer fire departments and rescue squads supported in whole or in part with public funds.

(22) *Public purpose* means a program or programs carried out by a public agency which are legally authorized in accordance with the laws of the State or political subdivision thereof and for which public funds may be expended. Public purposes include but are not limited to programs such as conservation, economic development, education, parks and recreation, public health, and public safety.

(23) *School* (except schools for the mentally retarded and schools for the physically handicapped) means a public or nonprofit approved or accredited organizational entity devoted primarily to approved academic, vocational, or professional study and instruction, which operates primarily for educational purposes on a full-time basis for a minimum school year and employs a full-time staff of qualified instructors.

(24) *School for the mentally retarded* means a facility or institution operated primarily to provide specialized

instruction to students of limited mental capacity. It must be public on nonprofit and must operate on a full-time basis for the equivalent of a minimum school year prescribed for public school instruction of the mentally retarded, have a staff of qualified instructors, and demonstrate that the facility meets the health and safety standards of the State or local governmental body.

(25) *School for the physically handicapped* means a school organized primarily to provide specialized instruction to students whose physical handicaps necessitate individual or group instruction. The schools must be public or nonprofit and operate on a full-time basis for the equivalent of a minimum school year prescribed for public school instruction for the physically handicapped, have a staff of qualified instructors, and demonstrate that the facility meets the health and safety standards of the State or local governmental body.

(26) *University* means a public or nonprofit approved or accredited institution for instruction and study in the higher branches of learning and empowered to confer degrees in special departments or colleges.

(27) *Programs for older individuals* means any State or local government agency or any nonprofit tax-exempt activity which receives funds appropriated for programs for older individuals under the Older Americans Act of 1965, as amended, under title IV or title XX of the Social Security Act, or under titles VIII and X of the Economic Opportunity Act of 1964 and the Community Services Block Grant Act.

(b) *Eligibility of public agencies*—(1) *Public agency*. Surplus personal property may be donated through the State agency to any public agency in the State. A public agency, as defined in §101-44.001-10, includes any:

(i) State or department, agency, or instrumentality thereof;

(ii) Political subdivision of the State, including any unit of local government or economic development district, or any department, agency, or instrumentality thereof;

(iii) Instrumentality created by compact or other agreement between States or political subdivisions;

(iv) Multijurisdictional sub-State districts established by or pursuant to State law; and

(v) Indian tribe, band, pueblo, or community located on a State reservation.

(2) *Public purpose.* Surplus personal property acquired through the State agency must be used by the public agency to carry out or to promote for the residents of a given political area one or more public purposes. While the act lists certain specific public purposes such as conservation, economic development, education, parks and recreation, public health, and public safety, this enumeration is not exclusive and is not intended to preclude the acquisition of donable surplus personal property by a public agency for other public purposes. In effecting fair and equitable distribution of property, based on the relative needs and resources of interested public agencies and other authorized donees and their ability to use the property, it is intended that the State agency give full and fair consideration to the requirements of public agencies for property necessary and usable for conservation, economic development, education, parks and recreation, public health and public safety, and other public purposes. Each public program is conducted by designated departments, agencies, or other instrumentalities of the State and/or local governments in carrying out either specific or diverse functions, with, in some cases, overlapping jurisdiction. Activities and functions involved in designated public programs may include but are not limited to the following:

(i) *Conservation.* State and local agencies and districts may be involved mutually in carrying out programs to conserve natural resources. Indian tribes or communities located on a State reservation may also be involved in conservation projects as well as other public programs such as economic development.

(ii) *Economic development.* Programs designed to develop the economy by establishing or expanding industry, commerce, or agriculture in a given geographic area and may include the economic development districts and other activities of public agencies involved in

activities such as municipal water and sewage departments operating sewage systems and waste treatment plants; State or local street or highway departments involved in construction or improvement of roads; port authorities and public airport commissions involved in harbor and public airport development; public transit authorities providing public transportation; environmental and antipollution programs of municipal, county, or State agencies; and State and local agencies involved in tourism development.

(iii) *Education.* Public schools, colleges, and universities are directly involved in the educational process. Special schools for the physically handicapped or the mentally retarded, as well as vocational and trade schools and educational radio and television stations, are among the educational institutions which directly contribute to the educational development of a district, town, city, county, or other governmental jurisdiction. Child care centers not only provide education benefits but also may promote economic development and public safety. Central administrative and service facilities of public school systems are equally necessary to successfully carry out and improve public education. Public libraries and museums also provide an essential educational and cultural service to a community.

(iv) *Park and recreation.* Agencies of the State, counties, cities, and other instrumentalities of local government are directly involved in the acquisition, development, improvement, and maintenance of public parks and other recreational facilities which benefit the general public. Public parks, playgrounds, swimming pools, and golf courses are some of the many public facilities which not only provide recreational benefits but also promote economic development, conservation, and public health.

(v) *Public health.* Public health services are directly provided by hospitals, clinics, health centers, and other designated medical institutions. Public agencies also provide broad public health benefits with regard to activities such as the control of communicable diseases, immunization, public health nursing, maternal and child

health programs, classes in health education and nutrition, and other health programs. These activities may be carried on in a clinic or subsidiary center in a community, in a person's home, in a school, or in a private business office of plant. Other vital programs carried on by State, county, or local health departments or other designated agencies directly protect public health and safety as well as promote economic development. These programs may include inspection of meat, food, and water; control and elimination of disease-carrying animals or insects by fogging, spraying, or other methods; water purification and water distribution systems; sewage treatment and disposal systems; garbage and trash disposal; and sanitary landfill facilities. These types of public health functions or services contribute directly to the general health and well being of the geographical area served, and public agencies may acquire surplus property to support these programs.

(vi) *Public safety.* Public safety includes not only law enforcement agencies but agencies involved in the prevention, control, and treatment of alcohol and drug abuse; agencies which provide services to children such as child care centers and activities serving neglected, dependent, abused, and delinquent children; and agencies and courts within the criminal justice system. Equally essential to public safety are State and local civil defense agencies and local fire departments and rescue squads. The availability of fire and rescue equipment at public airports is another illustration of an equally vital public safety requirement.

(vii) *Programs for older individuals.* State or local government agencies which receive funds appropriated for older individuals under the Older Americans Act of 1965, as amended, under title IV or title XX of the Social Security Act, or under titles VIII or X of the Economic Opportunity Act of 1964 and the Community Services Block Grant Act are eligible to receive surplus property through donation. Programs for older individuals include services that are necessary for the general welfare of older individuals, such as social services, transportation serv-

ices, nutrition services, legal services, and multipurpose senior centers.

(c) *Eligibility of nonprofit tax-exempt activities.* Surplus personal property may be donated through the State agency to nonprofit tax-exempt activities, as defined in this section, within the State, such as:

- (1) Medical institutions;
- (2) Hospitals;
- (3) Clinics;
- (4) Health centers;
- (5) Providers of assistance to homeless individuals;
- (6) Schools;
- (7) Colleges;
- (8) Universities;
- (9) Schools for the mentally retarded;
- (10) Schools for the physically handicapped;
- (11) Child care centers;
- (12) Radio and television stations licensed by the Federal Communications Commission as educational radio or educational television stations;
- (13) Museums attended by the public;
- (14) Libraries, serving free all residents of a community, district, State or region; or
- (15) Organizations or institutions that receive funds appropriated for programs for older individuals under the Older Americans Act of 1965, as amended, under title IV and title XX of the Social Security Act, or under titles VIII and X of the Economic Opportunity Act of 1964 and the Community Services Block Grant Act. Programs for older individuals include services that are necessary for the general welfare of older individuals, such as social services, transportation services, nutrition services, legal services, and multipurpose senior centers.

(d) *Educational and public health purposes.* Surplus personal property acquired through the State agency must be used by a nonprofit educational or public health institution or organization for purposes of education or public health as defined in this section, including research for any such purpose. While this does not preclude the use of donated property by an eligible nonprofit educational or public health institution or organization for a related or subsidiary purpose incident to the institution's overall program, the property must be used essentially for the

Federal Property Management Regulations

§ 101-44.207

primary educational or public health function for which the activity receives donable property and not for a non-related or commercial purpose. The enumeration of institutions and organizations in § 101-44.207(c) is descriptive and not exclusive and is not intended to preclude determinations by the State agency of eligibility for other nonprofit educational and public activities. These activities may include but are not limited to:

(1) Geriatric centers which are public health institutions and which furnish public health and medical services to the aged;

(2) Nursing homes which are public health institutions providing skilled nursing care and related medical services to individuals admitted because of illness, disease, or physical or mental infirmity. (A nursing home may be considered as a qualified public health institution if it is either a:

(i) Nursing home operated in connection with a hospital;

(ii) Facility for long-term care of convalescents, chronic disease patients, or other persons who require skilled nursing care and related medical services in which the nursing care and medical services are prescribed by or are performed under the general direction of persons licensed to practice medicine or surgery in the State; or

(iii) Nursing home certified to provide health services to medicaid or medicare patients under the provisions of the Social Security Act. (Nursing homes which do not meet these requirements or the primary purpose of which is domiciliary care will not be considered as qualifying as public health institutions); and

(3) Alcohol and drug abuse treatment centers which are clinics or medical institutions and which provide for the diagnosis, treatment, and rehabilitation of alcoholics and drug addicts. These centers should have available professional medical staffs on a regular visiting basis.

(e) *Determinations of eligibility.* The State agency is responsible for determining that an applicant is eligible as a public agency or a nonprofit educational or public health institution or organization to participate in the pro-

gram and receive donations of surplus personal property.

(f) *Application for eligibility.* Each State agency shall maintain a complete and current record for each eligible donee. This record shall include the following:

(1) *Application.* The application shall set forth the:

(i) Legal name and the address of the applicant;

(ii) Status of the applicant as a public agency or as an eligible nonprofit tax-exempt activity (evidence shall be included in the file that the applicant is a public agency or has been determined to be nonprofit and tax-exempt under section 501 of the Internal Revenue Code of 1954);

(iii) Details concerning the applicant's public program activities or, when it is an eligible nonprofit tax-exempt activity, the specific programs and facilities operated by the applicant (Sufficient details and specifics should be available so that the State agency can determine the program eligibility qualifications of the applicant, including any of those activities defined in § 101-44.207(a.); and

(iv) Evidence that the applicant is approved, accredited, or licensed, when it is a requirement of one or more of the applicant's programs, or certification of funding when the applicant is a nonprofit tax-exempt activity that conducts programs for older individuals.

(2) *Authorization.* A written authorization signed by the chief administrative officer or executive head of the donee activity, or a resolution by the governing board or body of the donee activity, which shall designate one or more representatives to act for the applicant acquiring donable property from the State agency, to obligate any necessary funds of the applicant for this purpose, and to execute the State agency distribution document including terms, conditions, reservations, and restrictions that the State agency or GSA may establish on the use and disposal of the property.

(3) *Assurance.* Necessary assurances that the applicant will comply with GSA regulations on nondiscrimination as set forth in subpart 101-6.2 and part

101-8 must be provided in the format prescribed by GSA.

(g) *Needs and resources.* In order that the State agency in distributing property can give fair and equitable consideration to the relative needs and resources of the donees within the State and their ability to use the property, the State agency may require each applicant, when submitting an application for eligibility determination, to provide a statement on the types and kinds of equipment, vehicles, machines, or other items of property needed by the applicant for use in the applicant's particular public programs, or, in the case of eligible nonprofit tax-exempt activities, the authorized programs to be served by the use of the equipment and the scope of these programs. The State agency may also request any financial information needed to evaluate the relative financial needs and resources of the applicant.

(h) *Maintaining eligibility.* The State agency shall update donee eligibility records as required to ensure continuing eligibility. Records for public agencies and nonprofit tax-exempt donees must be updated on a continuing basis, as frequently as necessary, to ensure that all documentation required to justify the donee's eligibility is current and accurate. Particular care must be taken to ensure that the donee resolution is current and that the statement of designated representatives contained therein is correct. When an eligible donee ceases to operate or when it loses its license, accreditation, or approval or otherwise fails to maintain its eligibility status, the State agency shall terminate its distribution of property to the activity.

(i) *Conditional eligibility.* In certain cases, newly organized activities may not have commenced operations or completed construction of their facilities, or may not yet have been approved, accredited, or licensed as may be required to qualify as eligible donees. In other cases, there may be no specific authority which can approve, accredit, or license the applicant as required for qualification. In these cases, the State agency may accept letters from public authorities, either local or State, which the State agency deems

competent (such as a board of health or a board of education) stating that the applicant otherwise meets the standards prescribed for approved, accredited or licensed institutions and organizations. In the case of educational activities, letters from three accredited or approved institutions that students from the applicant institution have been and are being accepted may be deemed sufficient by the State agency. In the case of public health institutions or organizations, licensing may be accepted by the State agency as evidence of approval in States where there is no authority which can as a legal or as a policy matter, approve hospitals, clinics, health centers, or medical institutions, provided the licensing authority prescribes the medical requirements and standards for the professional and technical services of the institution. If the construction of an applicant's facility or physical plant has not been completed, the State agency, after evaluating the progress and potential of the applicant, may at its discretion make available surplus items of property which can be immediately utilized at this point in the applicant's program. Under no circumstances shall conditional eligibility be granted to a potentially eligible nonprofit tax-exempt applicant before the State agency has received from the applicant a copy of a letter of determination by the Internal Revenue Service stating that the applicant is exempt from Federal taxation under section 501 of the Internal Revenue Code of 1954.

[42 FR 56003, Oct. 20, 1977, as amended at 43 FR 38009, Aug. 25, 1978; 45 FR 56809, Aug. 26, 1980; 53 FR 16115, May 5, 1988; 53 FR 47197, Nov. 22, 1988; 58 FR 39666, July 26, 1993]

§ 101-44.208 Property distributed to donees.

(a) *Distribution document.* Donation of surplus personal property shall be accomplished by the use of a prenumbered State agency distribution document which shall include the:

(1) Certifications and agreements required of the donee by the State agency, including an agreement to hold the Government harmless from any or all debts, liabilities, judgments, costs, demands, suits, actions, or claims of any nature arising from or incident to the

Federal Property Management Regulations

§ 101-44.208

donation of the property, its use, or final disposition;

(2) Condition that the donee will return to the State agency, at its own expense, any donated property that is not placed in use for the purposes for which it was donated within 1 year of donation, or which ceases to be used by the donee for those purposes within 1 year of being placed in use, provided the property is still usable as determined by the State agency or the donee agrees to make the property available for retransfer or other disposal by the State agency;

(3) Terms, conditions, reservations, and restrictions, imposed by the State agency as provided in the State plan of operation on the use of any item of property having a unit acquisition cost of \$5,000 or more and any passenger motor vehicle;

(4) Terms, conditions, reservations, or restrictions imposed on any other donated item by the State agency;

(5) Conditions imposed by GSA, if any, requiring special handling or use limitations on donated property; and

(6) Period of restriction during which the donee must use the property for the purpose for which it was acquired.

(b) *Donation purpose.* At the time donable surplus property is acquired by a donee, the donee's authorized representative shall indicate on the State agency's distribution document the primary purpose for which the property is to be used. In the case of public agencies, such usage could be for public purposes, such as conservation, economic development, education, parks and recreation, public health, programs for providing assistance to homeless individuals, public safety, museums, State Indians, or programs for older individuals. When the property is to be used for a combination of these purposes or for some other public purpose, the distribution document shall so indicate. With respect to nonprofit institutions or organizations, the purpose shall be shown as education, public health, programs for providing assistance to homeless individuals, museums, or programs for older individuals.

(c) *Conditional title.* Conditional title to surplus personal property shall pass to an eligible donee when the donee has executed the State agency distribution

document and taken possession of the property.

(d) *Utilization surveys.* The State agency shall make utilization surveys and reviews, as provided in the State plan of operation, to ensure that donated property during the period of restriction is being used by the donee for the purposes for which it was acquired.

(e) *Compliance.* The State agency shall take the necessary action to correct any noncompliance involving the use of donated property or to enforce the terms, conditions, reservations, and restrictions imposed on the use of the property, either by the State agency or GSA. Noncompliance may involve but not be limited to:

(1) Property not placed in use by the donee;

(2) Property no longer needed by the donee within the period of restriction;

(3) Unauthorized use of property by the donee during the period of restriction; or

(4) Unauthorized disposal of property by the donee during the period of restriction.

(f) *Enforcement of compliance.* Enforcement of compliance during the period of restriction may involve action by the State agency to:

(1) Place the property in proper use by the donee;

(2) Transfer the property to another donee having need and use therefor;

(3) Return the property to the State agency for distribution to other donees in the State or to another State agency having need and use therefor;

(4) Transfer the property through GSA to a Federal agency;

(5) Sell the property;

(6) Recover the gross proceeds realized from the disposal or the fair market value of the property, whichever is greater, when it is impossible or impracticable to recover property disposed of improperly during the period of restriction; and

(7) Recover the fair rental value if the property was used in an unauthorized manner during the period of restriction.

(g) *Coordination with GSA.* In enforcing compliance with the terms and conditions imposed on donated property, the State agency shall coordinate with GSA before undertaking the sale of, or

making demand for payment of the fair market value or fair rental value of donated property which:

(1) Is subject to any special handling condition or use limitation imposed by GSA or

(2) Has not been placed into use by the donee, for the purposes for which acquired, within 1 year of donation, or which has not been used for these purposes for 1 year after being placed in use.

(h) *Waivers.* A State agency may amend, modify, or grant releases for appropriate reasons from the terms, conditions, reservations, or restrictions it has imposed on the use of donated property, provided that it has set forth in the State plan of operation the standards by which actions shall be taken by the State agency. Amendments, corrections, or releases shall not be granted by the State agency, however, with respect to:

(1) The requirement that usable property be returned by the donee to the State agency if the property has not been placed in use for the purposes for which it was donated within 1 year of donation or ceases to be used by the donee for those purposes within 1 year of being placed in use; except that the State agency may grant authority to the donee to cannibalize or accomplish secondary utilization of property items subject to this requirement when the State agency determines that such action will result in increased utilization of the property and that the proposed action meets the standards prescribed in the State plan of operation with respect to amendments, modifications, or releases of the terms and conditions imposed on donated property; or

(2) Any special handling condition or use limitation imposed by GSA except with the prior approval of GSA.

(i) *Disposition of recovered property.* Personal property items returned to a State agency by a donee shall be redistributed by the State agency to other donees in the State or otherwise transferred or disposed of in accordance with the provisions of the State plan of operation if the property was returned (1) while subject to any special handling condition or use limitation imposed by GSA or (2) because the property had not been placed in use within 1 year of

donation for the purposes for which it was acquired, or not used for such purposes for 1 year after being placed in use. Personal property items returned by a donee while subject to terms, conditions, reservations, or restrictions imposed by the State agency may be redistributed, transferred, or disposed of as determined by the State agency.

(j) *Deposit of funds.* Any funds, including the gross proceeds of sale or the fair market value or the fair rental value of the property, derived by the State agency from enforcement of compliance involving a breach of any special handling condition or use limitation imposed on donated property by GSA, or involving donated property which had not been placed in use for the purposes for which it was acquired within 1 year of donation or not used for those purposes for 1 year after being placed in use by the donee, shall be remitted promptly by the State agency to GSA for deposit in the Treasury of the United States. The remittance shall be accompanied by supporting documentation indicating the source of the funds and essential background information. Funds derived by the State agency from the compliance action involving any term, condition, reservation, or restriction imposed on the donee by the State agency and funds derived by the State agency from any amendment, modification, or release thereof during the period of restriction may be retained and used by the State agency as provided in its plan of operation.

(k) *Reimbursement to donees.* (1) When a donee has used but no longer has a need or use for donated property which is subject to any special handling condition or use limitation imposed by GSA, and no breach of the conditions or limitations has occurred, the donee may be reimbursed on a prorated basis for the initial cost of repairs required to make the item usable when the property is transferred to a Federal agency or sold for the benefit and account of the United States of America.

(2) The State agency shall recommend for GSA approval the amount of reimbursement to which the donee is entitled, taking into consideration the benefit the donee has received from the

use of the property and making appropriate deductions therefor. In the case of sale, reimbursement to a donee for any item of property shall not exceed the proceeds of the sale of the item. Reimbursement for property to be transferred to a Federal agency will be made a condition of the transfer by GSA.

[42 FR 56003, Oct. 20, 1977, as amended at 45 FR 56810, Aug. 26, 1980; 53 FR 16116, May 5, 1988; 53 FR 47198, Nov. 22, 1988]

Subpart 101-44.3—Donations of Foreign Excess Personal Property

§ 101-44.300 Scope of subpart.

This subpart prescribes the policies and methods governing the return of foreign excess personal property to the United States for donation.

§ 101-44.301 Holding agency responsibilities.

Prior to any sale, exchange, lease, or donation of medical materials or supplies pursuant to the provisions of section 402 (a) or (b) of the Federal Property and Administrative Services Act of 1949, as amended, foreign excess personal property not required for further Federal use as determined by GSA shall be made available by the holding agency for selection and return to the United States for donation for the purposes of subpart 101-44.2 and, with respect to property returned from Department of Defense (DOD) activities, for the purposes of subpart 101-44.4. Any foreign excess personal property returned to the United States which has been identified as having been processed, produced, or donated by the American National Red Cross shall be made available for donation to the American National Red Cross for charitable purposes in accordance with subpart 101-44.6, unless otherwise directed by the Administrator of General Services.

§ 101-44.302 Donation screening.

(a) To locate and select donable property, onsite representatives of State agencies duly accredited by GSA shall be permitted to screen foreign excess personal property available for return

to the United States. Property not required for further Federal use, as determined by GSA, shall be available for donation for a period of time of not less than 10 calendar days unless otherwise agreed to by the holding agency and GSA. To assist donation screening, GSA will provide State agency representatives with available advance information concerning foreign excess property to the maximum extent possible.

(b) Property returned to the United States for further Federal use and thereafter determined surplus shall be made available for donation by GSA for the purposes set forth in subpart 101-44.2 and, with respect to property returned from DOD activities and then determined surplus, for donation by GSA without priority for the purposes of subpart 101-44.4.

§ 101-44.303 Donation approval.

(a) The Administrator of General Services is authorized to make donations at his discretion for the purposes of this subpart.

(b) Standard Form (SF) 123, Transfer Order Surplus Personal Property (see § 101-44.4901-123), prepared in accordance with instructions (see § 101-44.4901-123-1) and signed by a duly authorized official, shall be forwarded to the appropriate GSA office for approval for property covered by this subpart. An information copy shall be forwarded to the holding activity.

(c) Unless otherwise authorized by GSA, personal property shall not be released by the holding agency for donation pursuant to this subpart until it has received SF 123 bearing the signed approval of the appropriate GSA office.

§ 101-44.304 Shipment.

The State agency representatives shall arrange for the shipment of personal property approved for donation and allocated by GSA to State agencies for distribution to eligible donees. Upon request, the holding agency may provide packing, handling, crating, and transportation services on a reimbursable basis.

§ 101-44.305

41 CFR Ch. 101 (7-1-01 Edition)

§ 101-44.305 Costs incurred incident to donation.

All transportation costs and other direct costs incurred incident to donation, including packing, handling, and crating, shall be borne by the State agency or the donee institution or organization receiving the property, including any costs incurred and billed by GSA or the holding agency. Care shall be exercised by the State agencies in the selection of property to ensure that it is economical to return the items to the United States for donation, giving full consideration to transportation and accessorial costs.

§ 101-44.306 Statistics and reports.

The Administrator of General Services will maintain data on the acquisition cost of all personal property approved by GSA for donation pursuant to this subpart and will report these data to the Congress annually and at such other times as he may deem desirable.

Subpart 101-44.4—Donations to Service Educational Activities

SOURCE: 63 FR 56090, Oct. 21, 1998, unless otherwise noted.

§ 101-44.400 What are the responsibilities of DOD, GSA, and State agencies in the Service Educational Activity (SEA) donation program?

(a) *Department of Defense.* The Secretary of Defense is responsible for:

(1) Determining the types of surplus personal property under DOD control that are usable and necessary for SEAs.

(2) Setting eligibility requirements for SEAs and making eligibility determinations.

(3) Providing surplus personal property under the control of DOD for transfer by GSA to State agencies for distribution to SEAs.

(b) *General Services Administration.* The Administrator of General Services is responsible for transferring surplus personal property designated by DOD to State agencies for donation to eligible SEAs.

(c) *State agencies.* State agency directors are responsible for:

(1) Verifying that an activity seeking to obtain surplus DOD personal property is an SEA designated as eligible by DOD to receive surplus personal property.

(2) Locating, screening, and acquiring from GSA surplus DOD personal property usable and necessary for SEA purposes.

(3) Distributing surplus DOD property fairly and equitably among SEAs and other eligible donees in accordance with established criteria.

(4) Keeping a complete and accurate record of all DOD property distributed to SEAs and furnishing GSA this information as required in § 101-44.4701(e).

(5) Monitoring compliance by SEA donees with the conditions specified in § 101-44.208 (except §§ 101-44.208(a)(3) and (4), which do not apply to donations of surplus DOD personal property to SEAs).

§ 101-44.401 How is property for SEAs allocated and distributed?

(a) *Allocations.* GSA will make allocations in accordance with subpart 101-44.2 of this part, unless DOD requests that property be allocated through a State agency for donation to a specific SEA. Those requests will be honored unless a request is received from an applicant with a higher priority.

(b) *Distributions.* State agencies must observe all the provisions of § 101-44.208, except §§ 101-44.208(a)(3) and (4), when distributing surplus DOD personal property to eligible SEAs.

§ 101-44.402 May SEAs acquire non-DOD property?

Generally no. Surplus property generated by Federal civil agencies is not eligible for donation to SEAs, unless the SEAs also qualify under § 101-44.207 to receive donations of surplus personal property.

§ 101-44.403 What if a provision in this subpart conflicts with another provision in this part 101-44?

The provisions of this subpart shall prevail.

Subpart 101-44.5—Donations to Public Airports

§ 101-44.500 General.

Section 13(g) of the Surplus Property Act of 1944, as amended (50 U.S.C. App. 1622(g)), provides for the disposal of surplus personal property, with the approval of the Administrator of General Services, as determined by the Administrator of the Federal Aviation Administration to be essential, suitable, or desirable for the development, improvement, operation, or maintenance of a public airport.

§ 101-44.501 Agency authority.

(a) *Federal Aviation Administration.* The Administrator of the Federal Aviation Administration or his duly authorized representative shall:

(1) Determine requirements for surplus personal property of any State, political subdivision, municipality, or tax-supported institution for public airport use;

(2) Prescribe the eligibility requirements for public airport applicants and make determinations of eligibility;

(3) Determine whether available surplus personal property is essential, suitable, or desirable to fulfill the immediate or foreseeable future requirements for the development, improvement, operation, or maintenance of a public airport; and

(4) Determine and enforce compliance with the terms and conditions under which surplus personal property is transferred for public airport use.

(b) *General Services Administration.* Donations of surplus personal property for public airport purposes may be approved by the Administrator of General Services, at his discretion. Subject to that prior approval, surplus personal property determined essential, suitable, or desirable for public airport use by the Federal Aviation Administration (FAA) may be transferred direct to the specific public airport applicant.

§ 101-44.502 Application.

An applicant for surplus property to be used for public airport purposes shall make application to GSA using Standard Form 123, Transfer Order Surplus Personal Property, in accordance with § 101-44.110 for donation ap-

proval of surplus property determined by the Administrator of the Federal Aviation Administration or his duly authorized representative to be essential, suitable, or desirable for the development, improvement, operation, or maintenance of a public airport, or reasonably necessary to fulfill the immediate and foreseeable future requirements of the applicant for the development, improvement, operation, or maintenance of a public airport. Applications shall be prepared in accordance with § 101-44.111 and shall not require shipment of unreasonably small quantities.

§ 101-44.503 Surveillance.

FAA shall provide GSA with copies of internal instructions, and changes thereto, which outline the scope of its surveillance program for the enforcement of compliance with the terms and conditions of transfer established by GSA for surplus personal property donated to public airports.

§ 101-44.504 Reports.

In order for GSA to accumulate information as a basis for the exercise of its discretionary authority to approve the donation of surplus personal property, FAA shall make such reports on compliance actions involving donations to public airports as may be required from time to time by the Administrator of General Services.

Subpart 101-44.6—Donations to the American National Red Cross

§ 101-44.600 General.

Pursuant to section 203(1) of the Federal Property and Administrative Services Act of 1949 (40 U.S.C. 484), as amended, personal property which has been determined to be surplus property and which has been identified as having been processed, produced, or donated by the American National Red Cross shall, unless otherwise directed by the Administrator of General Services, be made available for donation to the Red Cross for charitable purposes.

§ 101-44.601 Donation approval.

The donation of surplus property for which the Red Cross is the eligible

§ 101-44.602

donee shall not require further GSA approval, unless the property has an estimated value in excess of \$500 or, in the case of blood plasma, consists of a quantity in excess of 1,000 units. In those instances in which the property to be donated exceeds the amounts stated, the GSA Regional Administrator for the area in which the property is located may approve the formal request submitted by the Red Cross.

§ 101-44.602 Cooperation of holding agencies.

Holding agencies shall cooperate with the Red Cross by informing the National Headquarters, Attention: General Supply Office, 17th and D Streets NW., Washington, DC 20006, of any surplus property in their custody which meets the criteria in § 101-44.600. By memorandum, letter, or other means of communication, the holding agencies shall provide information regarding suggested shipping facilities, quantity, description, condition, and location of such property in their inventories.

§ 101-44.603 Action by the Red Cross.

(a) Upon receipt of information from the holding agency regarding the availability of surplus personal property covered by this subpart, the Red Cross may inspect the property or request it pursuant to § 101-44.600 without inspection.

(b) The formal request and shipping instructions in duplicate shall be prepared and transmitted by the Red Cross to the holding agency activity having custody of the property within 20 calendar days from the date of notification of information provided for in § 101-44.602. Shipping instructions shall include a list of all such surplus property to be transferred and shall include reference to the date when information on which the request is based was received by the Red Cross. One copy of the request and shipping instructions shall be forwarded to the GSA regional office for the area in which the property is located.

(c) When the property to be donated exceeds the quantities stated in § 101-44.601, the Red Cross shall send three copies of the formal request and ship-

41 CFR Ch. 101 (7-1-01 Edition)

ping instructions to the designated GSA regional office for approval. Upon approval, the GSA regional office will mail two approved copies direct to the responsible activity of the holding agency.

§ 101-44.604 Transfer by holding agency.

The holding agency shall transfer direct to the Red Cross, upon receipt of the request and shipping instructions provided for in § 101-44.603, all items of surplus property requested. One copy of the request and shipping instructions shall be enclosed with the shipment or attached to shipping documents. The shipments shall be made f.o.b. installation, transportation charges collect.

§ 101-44.605 Donable property determined unusable by the Red Cross.

Property eligible for donation to the Red Cross which because of deterioration or for other reasons the Red Cross declines in writing to request as a donation, or as to which no action is taken by the Red Cross within the 20 calendar day period prescribed in § 101-44.603, shall be disposed of as other surplus. When the Red Cross property is offered for disposal, the disposal document shall provide for a certification to the effect that all Red Cross labels or other Red Cross identifications will be obliterated or removed from the property before use by the recipient or transfer by him to other users.

Subpart 101-44.7—Donations of Property to Public Bodies

§ 101-44.700 Scope of subpart.

This subpart prescribes the policies and methods governing the disposition by executive agencies by donation to public bodies of personal property which has no commercial value or of which the estimated cost of continued care and handling would exceed the estimated proceeds from its sale. This subpart does not apply to:

(a) Surplus personal property donated for the purposes of subparts 101-44.2, 101-44.4, and 101-44.5; or

Federal Property Management Regulations

§ 101-44.903

(b) Controlled substances (as defined in § 101-42.001) and combat material (as defined in § 101-46.001-2).

[42 FR 56003, Oct. 20, 1977, as amended at 57 FR 39136, Aug. 28, 1992]

§ 101-44.701 Findings justifying donation to public bodies.

§ 101-44.701-1 General.

(a) Property shall not be donated to public bodies by an executive agency unless it is affirmatively found in writing by a duly authorized official of the agency either that:

(1) The property has no commercial value, or

(2) The estimated cost of its continued care and handling would exceed the estimated proceeds from its sale.

(b) Findings shall not be made by any official directly accountable for the property covered thereby.

§ 101-44.701-2 Reviewing authority.

When a line item of the property to be disposed of under this subpart 101-44.7 by an executive agency at any one location at any one time had an original cost (estimated if not known) of more than \$1,000, findings made under § 101-44.701-1 shall be approved by a reviewing authority before any disposal.

§ 101-44.702 Donations to public bodies.

§ 101-44.702-1 Authority to donate.

Any executive agency may donate property to public bodies in accordance with § 101-44.701-1.

§ 101-44.702-2 Disposal costs.

Any public body receiving property from an executive agency pursuant to this subpart shall pay the disposal costs incident to the donation such as packing, preparation for shipment, demilitarization, loading, and transportation to the donee.

§ 101-44.702-3 Hazardous materials.

When hazardous materials as defined in part 101-42 are donated to a public body in accordance with this subpart, the head of the agency or designee authorized to make the donation shall be responsible for the safeguards, notifications, and certifications required by

part 101-42, and compliance with all other requirements therein.

[57 FR 39136, Aug. 28, 1992]

Subpart 101-44.8 [Reserved]

Subpart 101-44.9—Miscellaneous Statutes

§ 101-44.900 Scope of subpart.

Property disposed of under the following statutes is first subject to the requirements of subparts 101-44.2, 101-44.4, and 101-44.5. Disposals under these statutes do not require the approval of the Administrator of General Services.

§ 101-44.901 Condemned or obsolete material.

Pursuant to 10 U.S.C. 2572, the Secretary of a military department or the Secretary of the Treasury (and the Secretary of Transportation with regard to the functions of the Coast Guard transferred to him under Pub. L. 89-670, approved October 15, 1966) may lend or give, without expense to the United States, books, manuscripts, works of art, drawings, plans, models, and condemned or obsolete combat material that are not needed by that department to recipients specified in 10 U.S.C. 2572. However, records of the Government as defined in 44 U.S.C. 3306 shall not be disposed of under this § 101-44.901.

§ 101-44.902 Obsolete, condemned, or captured vessels.

Pursuant to 10 U.S.C. 7308, the Secretary of the Navy may transfer by gift or otherwise, on terms prescribed by him and set forth in 10 U.S.C. 7308 (b) and (c), any obsolete or condemned vessel of the Navy or any captured vessel in the possession of the Department of the Navy to recipients specified in 10 U.S.C. 7308.

§ 101-44.903 Obsolete naval material.

Pursuant to 10 U.S.C. 7541, the Secretary of the Navy may give obsolete material not needed for naval purposes and may sell other material that may be spared at a price representing its fair value to the Boy Scouts of America for the sea scouts, the Naval Sea Cadet Corps for the sea cadets, and the

§ 101-44.904

Young Marines of the Marine Corps League for the young marines. The costs of transportation and delivery of material given or sold shall be charged to the Boy Scouts of America, the Naval Sea Cadets, or the Young Marines of the Marine Corps League, as appropriate.

§ 101-44.904 Obsolete material and articles of historic interest.

Pursuant to 10 U.S.C. 7545, the Secretary of the Navy may lend or give, without expense to the United States, captured, condemned, or obsolete ordnance material; books, manuscripts, works of art, drawings, plans, and models; other condemned or obsolete material, trophies, and flags; and other material of historic interest not needed by the Department of the Navy to recipients specified in 10 U.S.C. 7545. However, records of the Government as defined in 44 U.S.C. 3306 shall not be disposed of under this § 101-44.904.

§ 101-44.905 Obsolete or other Coast Guard material.

Pursuant to 14 U.S.C. 641a, the Commandant of the Coast Guard may dispose of, with or without charge, obsolete or other material not needed for the Coast Guard to recipients specified in 14 U.S.C. 641a.

**Subparts 101-44.10—101-44.46
[Reserved]**

Subpart 101-44.47—Reports

§ 101-44.4701 Reports.

(a) [Reserved]

(b) The Administrator of General Services will submit by October 21, 1987, and annually thereafter, a report to the Congress that describes each program that is administered by the agency to assist homeless individuals and the number of homeless individuals served by each program; impediments, including any statutory and regulatory restrictions, to the use of these programs by homeless individuals; and efforts made by GSA to increase the opportunities for homeless individuals to obtain shelter, food, and supportive services.

(c) [Reserved]

41 CFR Ch. 101 (7-1-01 Edition)

(d) The Administrator of General Services will submit by April 30, 1991, and biennially thereafter, a report in duplicate to the President of the U.S. Senate and to the Speaker of the U.S. House of Representatives that covers the initial period from November 5, 1988, and each succeeding biennial period and contains a full and independent evaluation of the operation of programs for the donation of Federal surplus personal property; statistical information on the amount of excess personal property transferred to Federal agencies and provided to grantees and non-Federal organizations and surplus personal property approved for donation to the State agencies for surplus property and donated to eligible non-Federal organizations during each succeeding biennial period; and such recommendations as the Administrator determines to be necessary or desirable. A copy of each report will be simultaneously furnished to the Comptroller General of the United States. The Comptroller General shall review and evaluate the report and make any comments and recommendations to the Congress thereon, as he deems necessary or desirable.

(e) Each State agency shall submit a report in duplicate to the appropriate GSA regional office by the 25th day of the month following the quarter being reported, using GSA Form 3040, State Agency Monthly Donation Report of Surplus Personal Property. (The Office of Management and Budget Approval Number 3090-0112 has been assigned to this form.) Section 101-44.4902-3040 illustrates the GSA form and § 101-44.4902-3040-1 provides instructions for its use.

(f) Each State agency shall make such additional reports to GSA as may be required by the Administrator to carry out his discretionary authority to transfer surplus personal property for donation and to report to the Congress on the status and progress of the donation program.

[42 FR 56003, Oct. 20, 1977, as amended at 53 FR 16117, May 5, 1988; 53 FR 47198, Nov. 22, 1988; 54 FR 38676, Sept. 20, 1989; 62 FR 34013, June 24, 1997]

Subpart 101-44.48 [Reserved]

Subpart 101-44.49—Illustrations of Forms

§ 101-44.4900 Scope of subpart.

This subpart illustrates forms prescribed or available for use in connection with subject matter covered in this part 101-44.

§ 101-44.4901 Standard forms.

(a) Standard forms are illustrated in this section to show their text, format and arrangement and to provide a ready source of reference. The subsection numbers in this section correspond with the Standard form numbers.

(b) The Standard forms illustrated in this § 101-44.4901 may be obtained by Federal activities by submitting a requisition in FEDSTRIP/MILSTRIP format to the GSA regional office providing support to the requesting activity. State agencies may obtain copies of these forms from the U.S. Government Printing Office, Superintendent of Documents, Washington, DC 20402.

§ 101-44.4901-123 Standard Form 123, Transfer Order Surplus Personal Property.

§ 101-44.4901-123-A Standard Form 123-A, Transfer Order Surplus Personal Property (Continuation sheet).

NOTE: The form illustrated in § 101-44.4901-123-A is filed as part of the original document.

§ 101-44.4901-123-1 Instructions for preparing and processing Standard Form 123.

(a) *Preparing Standard Form 123*—(1) *General*—(i) The Standard Form 123 must include all information specified on the form. Particular care should be taken to ensure that the transfer order indicates the surplus release date (SRD), sometimes referred to as the automatic release date (ARD); identifies property as reportable or non-reportable; shows applicable GSA, Department of Defense (DOD), and holding activity control or report numbers; indicates the holding agency document or voucher number for nonreportable property; and contains authorized signatures in ink on the original (copies of transfer orders may have stamped

signatures). All other entries must be typed or printed. All city and State addresses shown on the form should include the ZIP code. Transfer orders received without sufficient information will be returned to the applicant or held in suspense until the missing information is obtained from the appropriate source. SF 123-A (Continuation sheet) shall be used for listing any additional property.

(ii) Reportable property, nonreportable property and property located at separate locations should not be requested on the same SF 123.

(iii) Recognized abbreviations for Federal agencies or donee organizations may be used in completing SF 123; e.g., GSA (General Services Administration); FAA (Federal Aviation Administration, Department of Transportation); SA (State agency); BSA (Boy Scouts of America); and DRMS (Defense Reutilization and Marketing Service).

(2) *Adjustments and disapprovals*. Any adjustment or partial disapproval made for the property listed in block 12 shall be initialed by the representative and/or officer signing in block 13b, 13d, 14b, or 14d. When a transfer order is disapproved in its entirety, the representative or officer who disapproves the action will return the SF 123 to the applicant with an explanation of the disapproval. When a line item is disapproved, it will be crossed out, marked “disapproved,” and initialed by the representative or officer making the deletion.

(3) *Entries*—(i) *Order number(s) (block 1)*. Enter the State serial number and/or transfer order and control numbers assigned by DOD, FAA, or the donees. If the continuation sheet (SF 123-A) is used, it must contain the same transfer order number(s).

(ii) *Type of Order (block 2)*. Insert “X” in the appropriate square to identify the type of order.

(iii) *Surplus Release Date (block 3)*. Enter the surplus release date, sometimes called the automatic release date, as follows:

(A) *DOD Property Reported to DRMS Only*. The correct date may be obtained from DRMS or the holding activity.

(B) *DOD Property Reported to GSA Through DRMS*. The correct date may

be obtained from DRMS, GSA, or the holding activity.

(C) *Executive Agency Property Reported Directly to GSA.* The correct date may be obtained from GSA or the holding agency.

(D) *Property Not Reported to DRMS or GSA.* The surplus release date is assigned by the holding agency (property disposal officer) and must be obtained therefrom. When nonreported property items with several surplus release dates are listed, each date should follow the respective line item and block 3 will not be completed.

(iv) *Set-Aside Date (block 4).* Enter the date on which nonreported property was set aside at the holding agency by an authorized donee representative, pursuant to §101-44.109. The insertion of a set-aside date will indicate to the GSA office that the property is available as surplus and that the holding agency has agreed to set the property aside pending receipt of donation approval.

(v) *Type of Property (block 5).* Insert an "X" in the appropriate square to identify the property as reportable or nonreportable to GSA. An "X" shall not be inserted to identify the property as nonreportable when any property listed is either reportable to GSA or had previously been reported on SF 120, Report of Excess Personal Property, to GSA in accordance with §101-43.311. Reportable property never loses its identity.

(vi) *Total Acquisition Cost (block 6).* Enter the sum of all the total costs shown under block 12(h) and on continuation sheets when appropriate.

(vii) *General Services Administration (block 7).* Add the street address, city, State, and ZIP code of the appropriate GSA office.

(viii) *Location of Property (block 8).* Insert the actual location of the property, including if available the warehouse or building number, street address, city, State, and ZIP code or other specific location of the property listed in block 12.

(ix) *Holding Agency (block 9).* Enter the complete name and address of the holding agency, including ZIP code; i.e., the executive agency which has accountability and administrative control over the property. It may or may

not be the same as the property location.

(x) *For GSA Use Only (block 10).* The GSA regional office will enter the appropriate codes in order to satisfy automated control reporting requirements.

(xi) *Pickup or Shipping Instructions (block 11).* Insert the name, address, including ZIP code, and telephone number of the State agency or donee representative to be notified of property availability when the property listed in block 12 is to be picked up. Enter shipping instructions when the property listed in block 12 is to be shipped. The applicant shall pay all transportation costs.

(xii) *Surplus Property List (blocks 12 (a), (b), (c), (d), (e), (f), (g), and (h))—(A) Line Item Number.* Enter in block 12(a) the identical number assigned to the line item on the document from which the control numbers indicated in block 12(b) are selected.

(B) *Identification Numbers.* Enter in block 12(b) pertinent identification numbers as follows:

(1) *GSA control number.* Military property reported to GSA through DRMS and all civilian and military agency property reported directly to GSA is assigned a GSA control number. The GSA control number may be obtained from the appropriate GSA office. In all cases in which a GSA control number is assigned, it must be entered on the SF 123.

(2) *DOD excess report number.* All excess property reported to DRMS is assigned a DOD excess report number. For such property subsequently reported to GSA, the DOD excess report number may be obtained from GSA or the DRMO/holding activity. The DOD excess report number for DOD property screened by DRMS but not reported to GSA for screening may be obtained from DRMS or the DRMO/holding activity. In all cases in which a DOD excess report number is assigned, it must be entered on the SF 123.

(3) *Holding agency control number.* The holding agency assigns a control number for all reportable property. For nonreportable property, the holding agency assigns a document or voucher number. This control number can be made available by the holding agency,

Federal Property Management Regulations

§ 101-44.4901-123-1

and in the case of reported property, by GSA or DRMS (for DOD property), as appropriate.

(C) *Description.* Enter in block 12(c) the item description. Include national stock number and noun name, if available. Otherwise, furnish Federal supply class number and commercial description, when possible. This space on the form may also be used to insert additional data pertinent to the description of the property; e.g., serial numbers and packaging information.

(D) *Demilitarization Code.* For munitions list items identified as requiring demilitarization, enter in block 12(d) the one-letter demilitarization code assigned to the property. This information is available from the document on which the property was originally listed.

(E) *Condition Code.* Enter in block 12(e) the identical condition code indicated for the line item on the document from which each item of property listed in block 12(c) was selected. Condition codes are illustrated at §101-43.4901-120-1.

(F) *Quantity and Unit of Issue.* Enter in block 12(f) the exact quantity and unit of issue (each, inches, feet, pounds, tons, dozen, gross, etc.) for each line item.

(G) *Unit Acquisition Cost.* Enter in block 12(g) for each line item the acquisition cost of the unit of issue indicated in block 12(f). This information is available from the document on which the property was originally listed.

(H) *Total Acquisition Cost.* Enter in block 12(h) for each line item the total acquisition cost of the quantity of unit of issue indicated in block 12(f). Care should be taken to ensure that the multiplication of the unit acquisition cost times quantity is correct.

(xiii) *Transferee Action (blocks 13 a, b, c, d, and e)*—(A) *State agency.* Enter in block 13a the name and address, including ZIP code, of the State agency which is making the request for the property. The authorized official of the State agency shall sign and enter his or her title in block 13b, and show in block 13c the date of signature.

(B) *Service educational activity.* Enter in block 13a the name and address of the school, club, or council specifically designated by the service educational

activity (SEA). Include the ZIP code and the county in which the SEA is located. Enter in block 13b the title of the authorized donee representative (an officer of the school, club, or council authorized to request donable surplus property). The donee representative shall sign in block 13b and enter the date in block 13c. The head of the SEA (school or national headquarters) shall indicate approval by signing in block 13d and entering the date of signature in block 13e.

(C) *Public airport.* Enter in block 13a the name and address of the public airport or the authorized State aeronautical agency which is requesting the property. Include the ZIP code and the county in which the public airport or State aeronautical agency is located. The authorized official of the public airport or State aeronautical agency or its designated representative shall sign and enter his or her title in block 13b, and show in block 13c the date of signature.

(xiv) *Administrative action*—(A) *Determining Officer (DOD or FAA) (blocks 14a, b, and c)*—(1) *Department of Defense.* For donation of nonreportable surplus property to service educational activities, enter in block 14a the name and address, including ZIP code, of the property disposal officer (PDO) controlling the property. The PDO shall sign in block 14b and enter the date in block 14c. The PDO shall not authenticate SF 123 for donations for a State agency or a public airport.

(2) *Federal Aviation Administration.* Enter in block 14a the name and title of the appropriate FAA official. The official shall sign in block 14b and enter the date in block 14c.

(B) *GSA Approving Officer (blocks 14d, e, and f).* Enter in block 14d the name and title of the GSA officer approving the order. The GSA officer will sign in block 14e and enter the date in block 14f.

(b) *Processing SF 123*—(1) *Public agencies and eligible nonprofit tax-exempt activities.* (i) Upon a determination that surplus property is necessary and useful for public agencies and eligible nonprofit tax-exempt activities, the State agency shall prepare and submit an original and five copies of SF 123 to the appropriate GSA office and shall send

an informational copy to the holding agency. The State agency official shall sign in block 13b. When the location of the property is different from that of the holding agency, an additional copy may be sent to the location for informational purposes. Block 11, "Pickup or Shipping Instructions," shall be completed, as well as blocks 13b and c.

(ii) At the time the property is determined surplus and approved for transfer by GSA, the GSA office will complete the SF 123 in blocks 14d, e, and f; retain one copy for the files; return two copies to the State agency; and send the original and one copy directly to the holding agency.

(iii) The holding agency upon receipt of the SF 123 shall release the property for donation promptly in accordance with the pickup or shipping instructions.

(2) *Service educational activity*—(i) *DOD property reported to DRMS.* (A) Transfer orders for property listed in DRMS excess listings shall be initiated by a school or the national headquarters of the SEA by transmitting an original and five copies of the SF 123 to its authorized donee representative. The SF 123 shall be completed except for block 13.

(B) The authorized donee representative shall complete blocks 13a, b, and c and return the original and four copies to the national headquarters if applicable. The fifth copy shall be retained by the authorized donee representative.

(C) The head of the SEA (school or national headquarters) shall indicate approval by signing block 13d of the SF 123 and entering the date in block 13e. That activity shall then forward the original and three copies of the SF 123 to DRMS, retaining the fourth copy for its files.

(D) DRMS shall hold the SF 123 until it determines the property excess to the needs of DOD. When the property is determined excess, the SF 123 (the original and three copies), with a copy of the excess report, shall be sent to the appropriate GSA regional office.

(E) At such time as the property is determined surplus and approved for transfer by GSA, the GSA office will complete blocks 14d, e, and f; retain one copy; send the original and one copy to the holding agency; and send

an informational copy to the State agency for the State in which the SEA school, club, or council is located.

(F) The property disposal officer, upon receipt of the approved SF 123 from GSA, shall release the property to the authorized donee representative in accordance with the pickup or shipping instructions shown in block 11.

(ii) *DOD property reported directly to GSA.* (A) Transfer orders shall be initiated by the authorized donee representative of the SEA by preparing an original and five copies of SF 123. The authorized donee representative shall complete blocks 13a, b, and c and send the original and four copies to the national headquarters if applicable. The fifth copy shall be retained by the authorized donee representative.

(B) The head of the SEA (school or national headquarters) shall indicate approval by signing block 13d of the SF 123 and entering the date in block 13e. That activity shall then forward the original and three copies of the SF 123 to the GSA regional office for the region in which the property is located, retaining the fourth copy for its files.

(C) At such time as the property is determined surplus and approved for transfer by GSA, the GSA office will complete blocks 14d, e, and f; retain one copy; send the original and one copy to the holding agency; and send an informational copy to the State agency for the State in which the SEA school, club, or council is located.

(D) The property disposal officer, upon receipt of the approved SF 123 from GSA, shall release the property to the authorized donee representative in accordance with the pickup or shipping instructions shown in block 11.

(iii) *DOD property not reported to either DRMS or GSA.* (A) Transfer orders shall be initiated by the authorized donee representative of the SEA by preparing an original and six copies of SF 123. The authorized donee representative shall complete blocks 13a, b, and c. The original and five copies shall be sent to the property disposal officer, who shall complete blocks 14a, b, and c.

(B) The property disposal officer shall retain one copy of the SF 123 and return the original and four copies to the authorized donee representative.

Federal Property Management Regulations

§ 101-44.4902-3040

(C) The authorized donee representative shall send the original and four copies of the SF 123 to the head of the SEA for approval if applicable. The head of the SEA shall indicate approval by signing block 13d and entering the date in block 13e. That activity shall then forward the original and three copies of the SF 123 to the GSA regional office for the region in which the property is located, retaining the fourth copy for its files.

(D) At such time as GSA approves the transfer, the GSA office will complete the SF 123 in blocks 14d, e, and f; retain one copy, send the original and one copy to the holding agency; and send an informational copy to the State agency for the State in which the SEA school, club, or council is located.

(E) The property disposal officer, upon receipt of the approved SF 123 from GSA, shall release the property to the authorized donee representative in accordance with the pickup or shipping instructions shown in block 11.

(3) *Public airport.* (i) The applicant shall prepare and submit an original and four copies of SF 123 to the appropriate FAA official for surplus property required for public airport purposes. The applicant shall sign in block 13b. One copy of SF 123 shall be sent to the holding agency by the applicant.

(ii) The appropriate FAA official shall indicate approval by completing blocks 14 a, b, and c; retain one copy; and send the original and three copies to the appropriate GSA office.

(iii) At such time as the property is determined surplus and approved for transfer by GSA, the GSA office will complete the SF 123 in blocks 14 d, e, and f; forward the original to the holding agency; return two copies to the appropriate FAA official; and retain one copy for the files.

(iv) The appropriate FAA official shall send one copy of the SF 123 to the applicant and retain one copy for the files.

(v) The holding agency, upon receipt of the approved SF 123, shall proceed to release the property for donation in accordance with the pickup or shipping instructions.

(c) *General information regarding SF 123.* (1) SF 123 is printed in a 10-part, snap-out set. Sets can be purchased by

FAA and DOD for distribution to authorized donees or applicants by ordering direct from the General Services Administration (FCNI), Washington, DC 20406. SF 123-A (Continuation sheet) can also be purchased from the same source. The continuation sheet is printed in a 10-part, snap-out set. State agencies may obtain copies of these forms from the U.S. Government Printing Office, Superintendent of Documents, Washington, DC 20402, or have them printed commercially. When printing these forms commercially, State agencies must ensure that the forms conform to the exact size, wording, arrangement, etc., of the approved Standard forms.

(2) SF 123 and SF 123-A sets are color coded, having two each of five different colors in each set.

(3) The SF 123 is designed for mailing in a 3 $\frac{7}{8}$ - by 8 $\frac{7}{8}$ -inch window envelope with a 1 $\frac{1}{8}$ - by 4-inch window positioned one-half inch from the bottom and three-fourths of an inch from the left side of the envelope. Slightly larger window envelopes may also be satisfactory, but the size and position of the window should not be altered. Copies should be folded along the horizontal line above block 11, and when inserted in a window envelope, the typed holding agency address will show through the window.

[53 FR 16117, May 5, 1988]

§ 101-44.4902 GSA forms.

(a) GSA forms are illustrated in this section to show their text, format, and arrangement, and provide a ready source of reference. The subsection numbers in this section correspond with the GSA form numbers.

(b) State agencies may obtain GSA Form 3040, State Agency Monthly donation Report of Surplus Personal Property, from the GSA regional office serving the geographical area in which the State agency is located.

§ 101-44.4902-3040 GSA Form 3040, State Agency Monthly Donation Report of Surplus Personal Property.

NOTE: The form illustrated in § 101-44.4902-3040 is file as part of the original document.

§ 101-44.4902-3040-1 Instructions for preparing GSA Form 3040.

GENERAL

Each report shall be signed and dated by an approving official and submitted in duplicate to the appropriate GSA regional office by the 25th day of the month following the quarter being reported.

A. *Beginning Inventory*— List the total original Government acquisition cost for all property on hand at the beginning of the report period.

B. *Property Received*— Original Government acquisition cost for:

1. From Federal agencies—Property received and posted to inventory records during the report period from Federal agencies other than that received from sources identified under 2, 3, and 4, below.

2. From other State agencies—Property received from other State agencies via an overage or SF 123 action and posted to inventory records during the report period.

3. From Overseas—Property received through the overseas program and posted to inventory records during the report period.

4. Other receipts—Property received from all other sources and posted to inventory records during the report period, including property released by Federal agencies without documents, property returned by donees, overages not previously posted, etc. Major receipts (over \$500 per line item) should be explained in detail under "Remarks."

C. *Property Donated*— Original acquisition cost of surplus property distributed to:

1. Public agencies (as defined in §101-44.001-10)—The original Government acquisition costs for donation to public agencies during the report period shall be identified for purposes of:

- a. Conservation.
- b. Economic development.
- c. Education.
- d. Parks and recreation.
- e. Public health.
- f. Public safety.

g. Two or more (when the donee indicates on the State agency distribution document that the property will be used equally for two or more public purposes).

h. Other (when the property will be used for a public purpose other than a through f).

2. Nonprofit institutions or organizations— As indicated in §101-44.207, donations to nonprofit institutions and organizations during the report period shall be identified by (a) educational and (b) public health purposes.

D. *Other Distribution*— Original Government acquisition cost for:

1. Transfer to other State agencies—Total acquisition cost of all property transferred to other State agencies and dropped from inventory during the report period as a result of an overage or SF 123 action.

2. Return to Federal agency—Total acquisition cost of all property returned to Federal agencies as approved by GSA and dropped from inventory during the report period with the exception of that property turned in for sale.

3. Sold—Total acquisition cost of all property dropped from inventory as a result of sales during the report period whether sold by the State agency or GSA.

4. Abandoned or destroyed—Total acquisition cost of all property dropped from inventory as a result of approved and documented abandonment or destruction actions during the report period.

5. Other adjustments—Total acquisition cost of all property redonated after having been returned from a donee, lost, stolen, or destroyed; shortages and inventory adjustments not previously posted, etc., which were dropped from inventory during the report period and documented in accordance with published procedures.

E. *Ending inventory*— To be computed by adding A and B, then subtracting C and D (A+B-C-D=E). F and G are for informational purposes only and are not included in E since they are already represented in C and D.

F. *Method of Distribution*— Total acquisition cost of property distributed during the report period identified as (1) distribution from a State agency facility or (2) picked up or shipped direct from the holding agency to a donee. (The total should be the same as the total of C and D.)

G. *Distribution to Public Agencies*— Total Government acquisition cost of property donated within the State during the reporting period.

1. Distribution to State public agencies such as State police departments, State hospitals, State parks, etc.

2. Distribution to county and local public agencies, such as a county civil defense unit, municipal health unit, county roads commission, etc.

(The total should be the same as the total of part 1 of C.)

Remarks—Use this area to report on donations to programs that provide assistance to homeless individuals. Include the total amount of property donated, the number of providers that received property, and the number of individuals (estimated if not known) served by each provider. If no donations were made to providers during the report quarter, an indication to that effect should be made.

[53 FR 16119, May 5, 1988, as amended at 53 FR 47198, Nov. 22, 1988]

Federal Property Management Regulations

Pt. 101-45

PART 101-45—SALE, ABANDONMENT, OR DESTRUCTION OF PERSONAL PROPERTY

Sec.

- 101-45.000 Scope of part.
- 101-45.001 Requests for deviations.

Subpart 101-45.1—General

- 101-45.101 Applicability.
- 101-45.102 Needs of Federal agencies par-amount.
- 101-45.103 Sales responsibilities.
 - 101-45.103-1 Conduct of sales.
 - 101-45.103-2 Holding agency sales.
 - 101-45.103-3 Sales by GSA.
 - 101-45.103-4 Sales conducted at holding agency facilities.
- 101-45.104 Care and handling pending disposal.
- 101-45.105 Exclusions and exemptions.
 - 101-45.105-1 Materials required for the national stockpile or the supplemental stockpile, or under the Defense Production Act.
 - 101-45.105-2 Disposal of certain vessels.
 - 101-45.105-3 Exemptions.
- 101-45.106 Property controlled by other law.
- 101-45.107 Holding agency compliance function.
 - 101-45.107-1 Referral to other Government agencies.
 - 101-45.107-2 Compliance reports.

Subpart 101-45.2 [Reserved]

Subpart 101-45.3—Sale of Personal Property

- 101-45.300 Scope of subpart.
- 101-45.301 [Reserved]
- 101-45.302 Sale to Government employees.
- 101-45.303 Reporting property for sale.
 - 101-45.303-1 Describing property.
 - 101-45.303-2 Display and inspection.
 - 101-45.303-3 Delivery.
- 101-45.304 Sales methods and procedures.
 - 101-45.304-1 Competitive bid sales.
 - 101-45.304-2 Negotiated sales and negotiated sales at fixed prices.
 - 101-45.304-3 [Reserved]
 - 101-45.304-4 Lotting.
 - 101-45.304-5 Inspection by bidders.
 - 101-45.304-6 Reviewing authority.
 - 101-45.304-7 Advertising.
 - 101-45.304-8 Forms prescribed.
 - 101-45.304-9 Credit.
 - 101-45.304-10 Deposits and final payments.
 - 101-45.304-11 Deposit bonds.
 - 101-45.304-12 Sales to State and local governments.
- 101-45.305 [Reserved]
- 101-45.306 Contractor inventory.
- 101-45.307 Proceeds from sales.
- 101-45.308 [Reserved]

- 101-45.309 Special classes of property.
 - 101-45.309-1 Agricultural commodities.
 - 101-45.309-2 Hazardous materials.
 - 101-45.309-3 Demilitarization and decontamination.
 - 101-45.309-4 [Reserved]
 - 101-45.309-5 Garbage.
 - 101-45.309-6—101-45.309-7 [Reserved]
 - 101-45.309-8 Bedding and upholstered furniture.
 - 101-45.309-9 Gold.
 - 101-45.309-10 Safes and locking file cabinets.
 - 101-45.309-11 [Reserved]
 - 101-45.309-12 Vehicle reconditioning.
 - 101-45.309-13 All terrain vehicles.
- 101-45.310 Antitrust laws.
- 101-45.311 Assistance in controlling unauthorized transport of property.
- 101-45.312 [Reserved]
- 101-45.313 Procedures and forms concerning contingent or other fees for soliciting or securing contracts.
 - 101-45.313-1 Purpose.
 - 101-45.313-2 Objectives and methods.
 - 101-45.313-3 Representation and covenant.
 - 101-45.313-4 General principles and standards applicable to the covenant.
 - 101-45.313-5 Standard Form 119, Contractor's Statement of Contingent or Other Fees.
 - 101-45.313-6 Use of Standard Form 119, Contractor's Statement of Contingent or Other Fees.
 - 101-45.313-7 Exceptions.
 - 101-45.313-8 Enforcement.
 - 101-45.313-9 Preservation of records.
- 101-45.314 Federal excise taxes.
- 101-45.315 Equal Opportunity clause in contracts.
 - 101-45.316 [Reserved]
 - 101-45.317 Noncollusive bids and proposals.
 - 101-45.318 Identical bids.

Subpart 101-45.4—Contract Disputes

- 101-45.400 Scope of subpart.
- 101-45.401 The disputes clause.
- 101-45.402 Alternative disputes resolution.

Subpart 101-45.5 [Reserved]

Subpart 101-45.6—Debarred, Suspended, and Ineligible Contractors

- 101-45.600 Scope of subpart.
- 101-45.601 Policy.
- 101-45.602 Listing debarred or suspended contractors.

Subpart 101-45.7—Submission of Bids

- 101-45.700 Scope of subpart.
- 101-45.701 Responsiveness of bids.
- 101-45.702 Time of bid submission.
- 101-45.703 Late bids.
 - 101-45.703-1 General.
 - 101-45.703-2 Consideration for award.

Pt. 101-45

- 101-45.703-3 Telegraphic bids.
- 101-45.703-4 Handcarried bids.
- 101-45.703-5 Disposition of late bids.
- 101-45.703-6 Records.
- 101-45.704 Modification or withdrawal of bids.
- 101-45.705 Late modifications and withdrawals.

Subpart 101-45.8—Mistakes in Bids

- 101-45.800 Scope of subpart.
- 101-45.801 General.
- 101-45.802 Apparent clerical mistakes.
- 101-45.803 Other mistakes disclosed before award.
- 101-45.804 Mistakes disclosed after award.
- 101-45.805 Mistakes disclosed after award in negotiated sales.

Subpart 101-45.9—Abandonment or Destruction of Personal Property

- 101-45.900 Cross-reference to the Federal Management Regulation (FMR) (41 CFR chapter 102, parts 102-1 through 102-220).

Subpart 101-45.10—Recovery of Precious Metals

- 101-45.1000 Scope of subpart.
- 101-45.1001 General.
- 101-45.1002 Agency responsibilities.
- 101-45.1002-1 Precious metals recovery surveys.
- 101-45.1002-2 [Reserved]
- 101-45.1002-3 Precious metals recovery program monitor.
- 101-45.1002-4 Internal audits.
- 101-45.1003 Recovery of silver from precious metals bearing materials.
- 101-45.1003-1 Guidelines for the recovery of silver from used hypo solution and scrap film.
- 101-45.1003-2 Recovery of silver from used hypo solution.
- 101-45.1003-3 Recovery of silver from scrap film.
- 101-45.1004 Recovery and use of precious metals through the DOD Precious Metals Recovery Program.
- 101-45.1004-1 Civil agency participation in the DOD Precious Metals Recovery Program.
- 101-45.1004-2 Use of DOD-recovered fine precious metals.

**Subparts 101-45.11—101-45.46
[Reserved]**

Subpart 101-45.47—Reports

- 101-45.4700 Scope of subpart.
- 101-45.4701 [Reserved]
- 101-45.4702 Negotiated sales reports.

41 CFR Ch. 101 (7-1-01 Edition)

Subpart 101-45.48—Exhibits

- 101-45.4800 Scope of subpart.
- 101-45.4801 Instructions for the preparation of advance notice to the Department of Commerce.
- 101-45.4802 Sample format—irrevocable letter of credit.
- 101-45.4803 General instructions for preparation of irrevocable letter of credit.
- 101-45.4804 Sample format—draft drawn against irrevocable letter of credit.
- 101-45.4805 Sample format—transmittal letter to accompany letter of credit.
- 101-45.4806 Outline for preparation of explanatory statement relative to negotiated sales.
- 101-45.4807 [Reserved]
- 101-45.4808 State health agencies.

Subpart 101-45.49—Illustrations of Forms

- 101-45.4900 Scope of subpart.
- 101-45.4901 Standard forms
- 101-45.4901-28 Standard Form 28, Affidavit of Individual Surety.
- 101-45.4901-97 Standard Form 97, The United States Government Certificate to Obtain Title to a Vehicle.
- 101-45.4901-97-1 Instructions for use of Standard Form 97.
- 101-45.4901-114 Standard Form 114, Sale of Government Property—Bid and Award.
- 101-45.4901-114A Standard Form 114A, Sale of Government Property—Item Bid Page—Sealed Bid.
- 101-45.4901-114B Standard Form 114B, Sale of Government Property—Item Bid Page—Sealed Bid.
- 101-45.4901-114C Standard Form 114C, Sale of Government Property—General Sale Terms and Conditions.
- 101-45.4901-114C-1 Standard Form 114C-1, Sale of Government Property—Special Sealed Bid Conditions.
- 101-45.4901-114C-2 Standard Form 114C-2, Sale of Government Property—Special Sealed Bid—Term Conditions.
- 101-45.4901-114C-3 Standard Form 114C-3, Sale of Government Property—Special Spot Bid Conditions.
- 101-45.4901-114C-4 Standard Form 114C-4, Sale of Government Property—Special Auction Conditions.
- 101-45.4901-114D Standard Form 114D, Sale of Government Property—Amendment of Invitation for Bids/Modification of Contract.
- 101-45.4901-114E Standard Form 114E, Sale of Government Property—Negotiated Sales Contract.
- 101-45.4901-114F Standard Form 114F, Sale of Government Property—Item Bid Page—Spot Bid or Auction.
- 101-45.4901-126 Standard Form 126, Report of Personal Property for Sale.

Federal Property Management Regulations

§ 101-45.103-2

- 101-45.4901-126A Standard Form 126A, Report of Personal Property for Sale (Continuation Sheet).
- 101-45.4901-150 Standard Form 150, Deposit Bond—Individual Invitation, Sale of Government Personal Property.
- 101-45.4901-151 Standard Form 151, Deposit Bond—Annual, Sale of Government Personal Property.
- 101-45.4902 GSA forms.
- 101-45.4902-27 GSA Form 27, Notice of Award (Sale of Government-Owned Personal Property).
- 101-45.4902-27A GSA Form 27A, Notice of Award—Continuation.
- 101-45.4903 Optional forms.
- 101-45.4903-15 Optional Form 15, poster, Sale of Government Property.
- 101-45.4903-16 Optional Form 16, Sales Slip, Sale of Government Personal Property.
- 101-45.4903-20 Optional Form 20, Notice to Surety—Deposit Bond—Annual Sale of Government Personal Property.

AUTHORITY: Sec. 205(c), 63 Stat. 390; 40 U.S.C. 486(c), §§101-45.400 to 101-45.405 also issued under sec. 307, 49 Stat. 880; 40 U.S.C. 304f.

SOURCE: 30 FR 2930, Mar. 6, 1965, unless otherwise noted.

§ 101-45.000 Scope of part.

This part prescribes policies and methods governing the disposal by public sale, or abandonment or destruction of personal property (including salvage, scrap, and waste materials) owned by the Government except for foreign excess property and the recovery of precious metals. Additional guidelines regarding the sale, abandonment, or destruction of hazardous materials are prescribed in part 101-42.

[57 FR 39137, Aug. 28, 1992]

§ 101-45.001 Requests for deviations.

Deviations from the regulations in this part shall only be granted by the Administrator of General Services (or designee). Requests for deviations shall be made in writing to the General Services Administration (FB), Washington, DC 20406, with complete justification. A copy of the authorizing statement for each deviation, including the nature of the deviation, the reasons for such special action, and the Administrator's or designee's approval, will be available for public inspection in accordance with subpart 105-60.3.

[53 FR 16120, May 5, 1988. Redesignated at 59 FR 50696, Oct. 5, 1994]

Subpart 101-45.1—General

§ 101-45.101 Applicability.

(a) This part 101-45 applies to all agencies in the executive, legislative, and judicial branches of the Government, except the Senate, the House of Representatives, and the Architect of the Capitol and any activities under his direction, to the extent provided in the Federal Property and Administrative Services Act of 1949, as amended (hereinafter generally referred to in this part 101-45 as “the Act”).

(b) The provisions of this part 101-45, relating specifically to sales of surplus personal property, do not apply to sales by the Secretary of Defense made pursuant to 10 U.S.C. 2576.

[34 FR 5172, Mar. 13, 1969]

§ 101-45.102 Needs of Federal agencies paramount.

Any need for personal property expressed by any Federal agency shall be paramount to any disposal, if such need is made known to the holding or selling agency prior to actual removal of the property from Government control in the case of sale.

[53 FR 16121, May 5, 1988]

§ 101-45.103 Sales responsibilities.

§ 101-45.103-1 Conduct of sales.

Heads of Federal agencies, or their designees, are responsible for determining whether their agencies will (a) report their personal property to the General Services Administration (GSA) for sale for a fee for services rendered or (b) conduct or contract for the sale of their own property. If agencies elect to sell their own property, a designation indicating such shall be entered on their reports of excess personal property to prevent GSA from automatically programming the property for sale.

[59 FR 50696, Oct. 5, 1994]

§ 101-45.103-2 Holding agency sales.

All provisions of Parts 101-45 and 101-46 shall be followed in conducting sales of Government-owned personal property. Agency internal procedures shall

§ 101-45.103-3

41 CFR Ch. 101 (7-1-01 Edition)

be issued to ensure compliance and uniformity and to protect the integrity of the sales process.

[59 FR 50697, Oct. 5, 1994]

§ 101-45.103-3 Sales by GSA.

(a) For property reported to GSA for disposal, the following basic services will be provided at reimbursable rates established by GSA on an annual basis.

(1) Auction and spot bid sales. The following services are covered under the basic rate:

- (i) Property cataloging;
- (ii) Maintenance of mailing list;
- (iii) Printing and distribution of announcement to bidders on mailing list;
- (iv) Normal media advertising (one newspaper or equivalent);
- (v) Registration of bidders;
- (vi) Auctioneer;
- (vii) Onsite contracting officer;
- (viii) Award document preparation;
- (ix) Onsite collection of proceeds;
- (x) Follow-on collection of late payments;
- (xi) Security service;
- (xii) Deposit of proceeds;
- (xiii) Distribution of proceeds;
- (xiv) Financial and property line item accountability; and
- (xv) Contract administration.

(2) Sealed bid sales. The following services are covered under the basic rate:

- (i) Property cataloging;
- (ii) Maintenance of mailing list;
- (iii) Printing/distribution of invitation for bids to bidders on mailing list;
- (iv) Bid opening;
- (v) Contract awards;
- (vi) Preparation of award documents;
- (vii) Financial and property line item accountability; and
- (viii) Contract administration;

(b) GSA will deduct service charges from the proceeds of sale.

(c) For sales proceeds that are reimbursable to the holding agency, net proceeds (sales proceeds less GSA's direct, and indirect costs) will be distributed to the agency via the on-line payment and accounting control (OPAC) system.

(d) A portion of the proceeds from the sale of nonreimbursable surplus property will also be retained by GSA to cover its direct and indirect costs. The

net proceeds will be deposited to miscellaneous receipts of the Treasury.

(e) Rates for accessorial services, including transportation, storage, maintenance, and reconditioning of property prior to sale, will vary according to local market conditions and will be published in GSA regional bulletins available from the servicing GSA region.

(f) Agencies may be consulted to assist GSA in the determination of the best method of sale and their requirements for accessorial services.

(g) Property for which the sales contract is terminated for default will be resold at no cost to the holding agency. Property for which the sales contract is terminated for cause, e.g., misdescription of the property, will be resold at the holding agency's cost if the cause is attributable to the holding agency.

[59 FR 50697, Oct. 5, 1994]

§ 101-45.103-4 Sales conducted at holding agency facilities.

If GSA sells property from holding agency facilities, holding agencies shall be responsible for the following:

(a) Providing the appropriate GSA regional office with information necessary for effective sale of property and the accounting data for appropriate application of gross proceeds;

(b) Transporting property to a consolidated sales site when agreed to by the holding agency and GSA;

(c) Providing for the inspection of property by prospective bidders;

(d) Providing facilities for the conduct of sales and the essential administrative, clerical, or labor assistance when requested by GSA; and

(e) Assisting in the physical lotting of property to be sold at agency facilities.

[59 FR 50697, Oct. 5, 1994]

§ 101-45.104 Care and handling pending disposal.

Pending disposal, each holding agency shall be responsible for performing, and bear the cost of, care and handling of its property.

Federal Property Management Regulations

§ 101-45.107-2

§ 101-45.105 Exclusions and exemptions.

§ 101-45.105-1 Materials required for the national stockpile or the supplemental stockpile, or under the Defense Production Act.

This part 101-45 does not apply to materials acquired for the national stockpile or the supplemental stockpile or to materials or equipment acquired under section 303 of the Defense Production Act of 1950, as amended (50 U.S.C. App. 2093). However, to the extent deemed appropriate the provisions of this part 101-45 should be followed in the disposal of such materials.

§ 101-45.105-2 Disposal of certain vessels.

The Secretary of Transportation has jurisdiction over the disposal of vessels of 1,500 gross tons or more which the Secretary determines to be merchant vessels or capable of conversion to merchant use.

[53 FR 16121, May 5, 1988]

§ 101-45.105-3 Exemptions.

Exemptions from the provisions of this Part 101-45 may be obtained by an agency head who believes that authority with respect to the programs covered by section 602(d) of the Act would be impaired or adversely affected by this part. Exemptions may be requested, in writing, from the Administrator of General Services.

[59 FR 50697, Oct. 5, 1994]

§ 101-45.106 Property controlled by other law.

No property shall be disposed of in violation of any other applicable law.

§ 101-45.107 Holding agency compliance function.

Subject to the provisions of § 101-45.107-1 requiring referral of criminal matters to the Department of Justice, each holding agency shall perform investigatory functions as are necessary to insure compliance with the provisions of the Federal Property Act and with the regulations, orders, directives, and policy statements of the Administrator of General Services. Nothing in this § 101-45.107 should be deemed to af-

fect the jurisdiction of any agency over its own personnel or any existing arrangements with Department of Justice concerning the handling and prosecution of criminal matters.

§ 101-45.107-1 Referral to other Government agencies.

All information indicating violations by any person of Federal criminal statutes, or violations of section 209 of the Federal Property Act, including, but not limited to, fraud against the Government, mail fraud, bribery, attempted bribery, or criminal collusion, shall be referred immediately to the Department of Justice, for further investigation and disposition. Each holding agency shall make available to the Department of Justice, or to such other governmental investigating agency to which the matter may be referred by the Department of Justice, all pertinent information and evidence concerning the indicated violations; shall desist from further investigation of the criminal aspects of such matters except upon the request of the Department of Justice; and shall cooperate fully with the agency assuming final jurisdiction in establishing proof of criminal violations. After making the necessary referral to the Department of Justice, inquiries conducted by the holding agency compliance organizations shall be limited to obtaining information for administrative purposes. Where irregularities reported or discovered involve wrongdoing on the part of individuals holding positions in Government agencies other than the agency initiating the investigation, the case shall be reported immediately to the Administrator of General Services for an examination in the premises.

§ 101-45.107-2 Compliance reports.

A written report shall be prepared on all compliance investigations conducted by each agency compliance organization. Each holding agency shall maintain files of all such reports. Until otherwise directed by the Administrator of General Services, there shall be transmitted promptly to GSA one copy of any such report which contains information indicating criminality on the part of any person or indicating substantial noncompliance with the

§ 101-45.300

Act or with the regulations, orders, directives, and policy statements of the Administrator of General Services. In transmitting such reports to the Administrator of General Services, the agency shall set forth the action taken or contemplated by the agency to correct the improper conditions disclosed by the investigation. Where any matter is referred to the Department of Justice, a copy of the letter of referral shall be transmitted to GSA.

Subpart 101-45.2 [Reserved]

Subpart 101-45.3—Sale of Personal Property

§ 101-45.300 Scope of subpart.

This subpart prescribes the policies and methods governing the disposal of personal property by sale.

§ 101-45.301 [Reserved]

§ 101-45.302 Sale to Government employees.

To the extent not prohibited by the regulations of an executive agency, an employee of such agency (either as a civilian or as a member of the Armed Forces of the United States, including the U.S. Coast Guard, on active duty) may be allowed to purchase Government personal property. The term employee as used in this section includes an agent or immediate member of the household of the employee.

[35 FR 14134, Sept. 5, 1970]

§ 101-45.303 Reporting property for sale.

If holding agencies elect to have GSA sell their property, it shall be reported to the appropriate GSA regional office for the region in which the property is physically located in the manner outlined below:

(a) *Reportable property.* Property required to be reported to the GSA regional offices for utilization screening as set forth in part 101-43, if not transferred or donated, will be programmed for sale by the GSA regional office.

(b) *Nonreportable property.* Property not required to be reported for utilization screening and for which any required donation screening has been

41 CFR Ch. 101 (7-1-01 Edition)

completed shall be reported to the appropriate GSA regional office on Standard Form 126, Report of Personal Property for Sale (illustrated in § 101-45.4901-126). Standard Form 126A, Report of Personal Property for Sale—Continuation Sheet, shall be used if additional pages are required. Standard Forms 126 and 126A are stocked as five-part carbon interleaved forms and may be obtained by submitting a requisition in FEDSTRIP/MILSTRIP format to the GSA regional office providing support to the requesting activity.

[30 FR 2930, Mar. 6, 1965, as amended at 31 FR 5000, Mar. 26, 1966; 42 FR 40852, Aug. 12, 1977; 59 FR 50697, Oct. 5, 1994]

§ 101-45.303-1 Describing property.

In the interest of good business practice, property reported for sale shall be described in commercial terminology and as fully and accurately as possible, including its condition.

§ 101-45.303-2 Display and inspection.

Holding agencies shall assist prospective bidders to the maximum extent possible during the inspection period prescribed in the sales offering. However, no information shall be provided to a prospective bidder which is not available to all bidders.

§ 101-45.303-3 Delivery.

(a) After full payment has been received from a buyer, the GSA regional office will notify the holding activity by copy of the GSA Form 27A, Purchaser's Receipt and Authority to Release Property, that property may be released to the purchaser. (See §§ 101-45.4902-27A (over-the-counter and self-mailer)). Upon completion of a sale, the servicing GSA finance office will simultaneously forward to the holding activity additional copies of the GSA Form 27A and completed copies of Standard Form 1081, Voucher and Schedule of Withdrawals and Credits, for use as internal accounting documents.

(b) If a purchaser fails to remove property within the period specified, the GSA regional office shall be advised of this fact, in writing, immediately in order that appropriate action may be taken.

Federal Property Management Regulations

§ 101-45.304-2

(c) The Standard Form (SF) 97, the United States Government Certificate to Obtain Title to a Vehicle, is a four-part form issued on continuous feed paper. The original certificate is produced on secure paper to readily identify any attempt to alter the form. The SF 97 shall be signed in accordance with requirements established by the head of the agency selling the vehicle. The SF 97 is an accountable form and is serially numbered during the printing process. Each agency shall have an accountable officer who will be responsible for the requisition, storage, and issuance of the SF 97. Certificates showing erasures or strikeovers will be considered invalid. Proper precautions shall be exercised by all agency accountable officers to prevent blank copies of the SF 97 from being obtained by unauthorized persons.

(d) Delivery of motor vehicles to purchasers shall be evidenced by submission to the purchaser of a completed original of the SF 97. Two copies of the SF 97 shall be furnished to the owning agency (one copy for the reporting office and one copy for the custodian) and the other copy shall be furnished the contracting officer of the agency effecting the sale or transfer of the motor vehicle. The SF 97 is illustrated at §101-45.4901-97. Other certificates of release or bills of sale shall not be used in lieu of the SF 97. Instructions for the use of the SF 97 are in §101-45.4901-97-1.

[53 FR 16121, May 5, 1988, as amended at 57 FR 32446, July 22, 1992]

§ 101-45.304 Sales methods and procedures.

§ 101-45.304-1 Competitive bid sales.

Except as provided in §101-45.304-2, property shall be sold by competitive bid sale after advertising, in accordance with this §101-45.304-1. Competitive bid sales include the following:

(a) *Sealed bid sales.* In sealed bid sales, bidders shall be required to submit, to the office designated for receipt and opening of bids, sealed written bids on authorized bid forms for public opening at a time and place designated.

(b) *Spot bid sales.* In spot bid sales, bidders shall be furnished with bid forms in advance of the bidding, a bid

form to be used for each lot or unit to be separately sold. Requests for bids on items offered for sale shall be made by the official in charge. In requesting bids, the official in charge shall announce the item, its identification number, and a brief description of the item or lot. The right to reject all such bids for a lot or item shall be reserved in the terms of sale; and when the Invitation for Bids so specifies, lots or items for which all bids have been rejected may be reoffered at the same sale in order to secure an acceptable bid price. After examining all bids, award shall be made or bids rejected immediately following the offering of the item or lot. The bids at spot bid sales shall not be disclosed prior to the announcement of award for any item or lot. Where mailed written or drop bids are permitted, they shall not be disclosed to the public prior to the announcement of award. Bidders may be required to register in advance of the sale. Any special condition of sale shall be set out in the Invitation for Bids in order to assure that all bidders are afforded an opportunity to compete on the same terms and conditions.

(c) *Auction sales.* When the terms and conditions of sale have been published and distributed to participating buyers, any special or unusual conditions of sale shall be announced by the person conducting the auction, immediately prior to commencement of the sale. Offerings must reserve in the Government, the right to accept or reject any or all bids. Lots for which all offers have been rejected may be reoffered later at the same sale to secure acceptable bids, when the published terms and conditions so provide.

§ 101-45.304-2 Negotiated sales and negotiated sales at fixed prices.

(a) *Circumstances permitting negotiated sales.* While it is the policy to sell property after publicly advertising for bids, property also may be sold by negotiation, subject to obtaining such competition as is feasible under the circumstances, where:

(1) It is determined by the agency that the sale involves property:

(i) That has an estimated fair market value not in excess of \$15,000;

(ii) Where public exigency will not admit of the delay incident to advertising;

(iii) Where bid prices after advertising therefor are not reasonable (either as to all or some part of the property), or bid prices have not been independently arrived at in open competition, and it is determined that readvertising will serve no useful purpose: *Provided*, That all responsible bidders who responded to the previous advertising shall be afforded an opportunity to submit offers for the property; or

(iv) That the disposal will be to a State, territory, possession, political subdivision thereof, or tax-supported agency therein, and that the estimated fair market value of the property and other satisfactory terms of disposal are obtained by negotiation. (See §101-45.304-12.)

(2) Full and adequate justification therefor has been submitted to the head of the selling agency or his designee for prior approval, and he has determined:

(i) That the public health, safety, or national security will thereby be promoted; or

(ii) That it is necessary in the public interest during the period of a national emergency declared by the President or the Congress. The authority of this subdivision shall be used only with respect to a particular lot or lots of personal property identified by the Administrator of General Services or a specifically described category or categories of property determined by the Administrator of General Services during any period fixed by the Administrator of General Services, but not in excess of three months. Declaration of a national emergency alone is not justification for use of this authority; there must be other reasons making use of negotiation necessary in the public interest.

(3) Full and adequate justification therefor has been submitted to the Administrator of General Services for his prior approval, and he has determined that the property involved is of a nature and quantity which, if disposed of by advertising would cause such an impact on an industry or industries as to adversely affect the national economy: *Provided*, That the estimated fair mar-

ket value of such property and other satisfactory terms of disposal can be obtained by negotiation.

(4) Negotiation is otherwise authorized by the Act or other law.

(b) *Negotiated sales at fixed prices.* (1) Property may be sold at fixed prices, either directly or through the use of disposal contractors, only with prior approval by the Administrator of General Services (or designee) of the property categories to be sold.

(2) In accordance with §101-45.304-12, prior to offering property to the public, it may be offered at fixed prices, through State agencies for surplus property, to State and local governments (States, territories, possessions, political subdivisions thereof, or tax-supported agencies therein) which have expressed an interest in the property.

(c) *Explanatory statements.* Subject to the exceptions stated in §101-45.304-2(c)(2), the selling agency shall prepare an explanatory statement as required by section 203(e)(6) of the Act of the circumstances of each proposed disposal by negotiation.

(1) Ten copies of each explanatory statement, mechanically reproduced, shall be submitted to the Administrator of General Services for review and transmittal by the Administrator to the appropriate committees of the Senate and House of Representatives and a copy thereof shall be preserved in the files of the selling agency. Such statements shall be submitted as early as practicable in advance of each proposal. Copies of the Administrator's transmittal letters to the committees will be furnished to the selling agency. In the absence of any action by a committee on the proposed negotiated disposal, the selling agency may consummate the sale on or after 35 days from the date of the Administrator's letters transmitting the explanatory statement to the committees.

(2) The explanatory statement need not be:

(i) Transmitted for a disposal of personal property at fixed prices when previously authorized pursuant to §101-45.304-2(b);

(ii) Transmitted for a disposal of personal property authorized to be made without advertising by any provision of

Federal Property Management Regulations

§ 101-45.304-7

law other than section 203(e) of the Act; or

(iii) Prepared for a disposal of personal property having a fair market value of \$15,000 or less.

(3) An outline for the preparation of the explanatory statement is shown in § 101-45.4806.

[30 FR 2930, Mar. 6, 1965, as amended at 31 FR 5001, Mar. 26, 1966; 34 FR 7329, May 6, 1969; 42 FR 40853, Aug. 12, 1977; 54 FR 38676, Sept. 20, 1989; 55 FR 17609, Apr. 26, 1990]

§ 101-45.304-3 [Reserved]

§ 101-45.304-4 Lotting.

To the extent practicable, and consistent with the types of property and usual commercial practice, property offered for sale shall be assembled in reasonably sized lots of like or similar items by make or manufacturer. Unused property shall be lotted separately from used items. Scrap and other property having scrap value only shall be lotted in accordance with established trade practice and shall generally not be included in the same sale with usable items. Determination of the size of lots shall take into consideration the buying capacities of prospective buyers and the requirement that adequate competition be obtained. Large quantities of identical items shall be lotted in such a way as to encourage bidding by small businesses and individuals.

§ 101-45.304-5 Inspection by bidders.

Sufficient time prior to the date for submission of bids shall be allowed to permit inspection by potential bidders. Such time should be a minimum of 7 or a maximum of 21 calendar days, depending upon the circumstances of the sale, the method of the sale, or the volume of property offered for sale. Whenever the inspection period is proposed to be less than 7 days, invitations for bids, flyers, or other announcements shall be distributed to prospective bidders sufficiently in advance of the inspection period.

[31 FR 5001, Mar. 26, 1966]

§ 101-45.304-6 Reviewing authority.

(a) A "reviewing authority" is a local, regional, or departmental board of review of an executive agency. Under

subpart 101-45.9, reviewing authority also includes an applicable State board of review of a State agency for surplus property.

(b) Approval by reviewing authority of the agency effecting the sale shall be required for each proposed award when the contract value (actual or estimated fair market value) for property other than scrap exceeds the dollar thresholds listed below by method of sale:

(1) Negotiated sale of surplus property—\$15,000 or more;

(2) Negotiated sale at fixed price of surplus or exchange/sale property—\$25,000 or more; and

(3) Competitive bid sale—\$100,000 or more.

[59 FR 50697, Oct. 5, 1994]

§ 101-45.304-7 Advertising.

Adequate public notice shall be given to each offering for sale of property to be disposed of after advertising. Except where the nature or condition of the property does not permit, advertising shall be made in sufficient time previous to sale to permit full and free competition. The extent of solicitation shall have due regard to the quantity and type of property to be sold, the logical market of disposal, the type of sale contemplated, and the public interest.

(a) *Advertising media by type of sales*—
(1) *Sealed bid sales.* In the case of sealed bid sales, advertising shall be by the distribution of written invitations for bids including public posting thereof and may be supplemented by newspaper or trade journal advertising (ordered in accordance with existing law) where advisable.

(2) *Spot bid sales.* Advertising in the case of spot bid sales shall be by written invitation for bids or other appropriate notices, including public posting thereof. Notice of such sales may also be given by appropriate newspaper or trade journal advertising (ordered in accordance with existing law) where advisable.

(3) *Auction sales.* In the case of auction sales, newspaper or trade journal advertising ordinarily should be employed (ordered in accordance with existing law) in addition to other written notice deemed appropriate.

(b) *Advance sale notices to Department of Commerce.* In order that the Department of Commerce may publish regularly synopsis of principal proposed sales of Government personal property, the sales office shall, when the acquisition cost of the property to be sold at one time at one place is \$250,000 or more, forward a notice of each proposed sale to the U.S. Department of Commerce, room 1300, 433 West Van Buren Street, Chicago, IL 60607. Where the acquisition cost is less than this amount, the notice may be transmitted when considered desirable. The notice shall be sent as early as possible in advance of the sale but at least 20 days prior to the date when the bids will be opened, or, in the case of spot bid or auction sale, when the sale will be conducted. The notice shall be transmitted by fastest mail available and shall be in synopsis form suitable for printing directly from the text as transmitted without editing or condensing. Instructions for the preparation of advance sale notices, including form and content thereof are set forth in §101-45.4910. The failure to comply with the advance notice of sale requirements of this §101-45.304-7(b) shall not, in and of itself, affect the validity of a sales award which is otherwise valid.

(c) The appropriate GSA regional office shall be provided, at the time of public distribution, a copy of each invitation for bids or other form of offering involving contractor inventory, whether being sold by the contractor for the Government or by a Government activity authorized to conduct sales.

[30 FR 2930, Mar. 6, 1965, as amended at 42 FR 40853, Aug. 12, 1977; 52 FR 23831, June 25, 1987; 59 FR 50697, Oct. 5, 1994]

§ 101-45.304-8 Forms prescribed.

Standard Forms 114, 114A, 114B, 114C, 114C-1, 114C-2, 114C-3, 114C-4, 114D, 114E, and 114F (illustrated at §§1010-45.4901-114 through 101-45.4901-114F) shall be used, where appropriate, in sales of personal property except that Standard Form 114C is not applicable to those sales involving any strategic metals, minerals, and ores which have been determined surplus pursuant to the Act. These forms will be stocked by GSA as cut sheets only. Authority for the use of such forms in styles other

than cut sheets may be granted when requests for such deviation are submitted in accordance with §101-26.302.

(a) *Deviation.* To ensure inclusion of appropriate terms, conditions, clauses, etc., in Government sales contracts, no deviation shall be made from the Standard Form 114 series, and no special conditions of sales shall be included that are inconsistent with the provisions contained therein, unless approval is obtained from the Commissioner, Federal Supply Service (F) (mailing address: General Services Administration, Washington, DC 20406).

(b) *Cover sheet.* The development and use of a cover sheet will be at the option of the selling agencies. However, if a cover sheet is used, it should be developed so as to be uniform for and identified primarily with the selling agency and secondarily with the selling activities of such agency. The cover sheet should contain only the "what-where-when" types of information, such as the method of sale (i.e., sealed bid, spot bid, auction); sale (invitation for bids) number; general category(ies) of property being offered; identification of the selling activity; inspection period; and the bid opening time and date of the sale. Nothing of a binding nature either on the part of the bidder or the Government shall be included on this cover sheet.

(c) *Description of standard forms—(1) Standard Form 114, Sale of Government Property—Bid and Award.* (i) Standard Form 114, has spaces to be completed by the issuing sales activity and the bidder. Some of the information furnished by the issuing sales activity is as follows: Invitation for bids number; name and address of issuing sales activity; person to contact for sales information; address to which bids should be mailed; place, date, and time of bid opening; whether or not bid deposit is required; and the number of days for payment to be made and property to be removed. In addition, the form provides that the Standard Form 114C, General Sale Terms and Conditions, and the standard form of special conditions applicable to the method of sale being employed are made a part of the invitation for bids by reference. The block indicating the standard form

of special conditions for the appropriate method of sale must be checked by the issuing sales agency. If special terms and conditions in addition to those contained in the prescribed standard forms are to be made a part of the invitation by reference, such additional terms and conditions should be identified by a form number and so indicated in the appropriate place on Standard Form 114. Special terms and conditions that are not identified by a form number must be included in the invitation and not made a part thereof by reference. Standard Form 114C and the applicable standard form of special conditions may be attached to the invitation for bids at the option of the executive agency. Information to be furnished by the bidder is as follows: Number of days but not less than 10, for Government's acceptance of the bid, if desired; total amount of bids; amount and form of bid deposit, when required; whether or not property was inspected; small business representation; and contingent fee representation. Standard Form 114 shall be made a part of sealed bid sales and may be used in auction and spot bid sales.

(ii) The time set for bid opening or commencement of a sale shall be the local time at the place of bid opening or sale and shall be indicated in the appropriate block on Standard Form 114. The opening time shall include the phrase "local time at the place of bid opening" in lieu of references to "daylight time" or "daylight saving time" and abbreviations such as "EDT" or "PDT." Where the block on Standard Form 114 does not readily permit the inclusion of the phrase "local time at the place of bid opening," an asterisk shall be used to call attention to an explanatory phrase which shall be stated elsewhere in the invitation for bids. The time set for commencement of spot bid and auction sales shall also be the local time at the place of sale and shall be indicated in an appropriate place in invitations for bids and sales offerings.

(2) *Standard Form 114A, Sale of Government Property—Item Bid Page—Sealed Bid.* Standard Form 114A requires entries to be made by the bidder prior to submission of bid. It provides for the bidder to enter the item number of the

property on which he is bidding, his offered unit price bid per item, and his total price bid per item. Except as provided in paragraph (3) of this paragraph (c), Standard Form 114A shall be made a part of sealed bid sales.

(3) *Standard Form 114B, Sale of Government Property—Item Bid Page—Sealed Bid.* Standard Form 114B may be used in lieu of Standard form 114A only when:

(i) The number of items of property being sold can be described sufficiently on one page;

(ii) Property is offered on an "as generated" basis (term-type sale);

(iii) Bidding on an increment basis is permitted by the terms and conditions of the sale; or

(iv) The use of Standard Form 114A might not be appropriate, in which case a short, accurate, and to the extent feasible, commercially clear description shall be prepared for each item offered for sale.

(4) *Standard Form 114C, Sale of Government Property—General Sale Terms and Conditions.* Standard Form 114C, is applicable to all sales of personal property (including sales by negotiation) and shall be made a part of all sales invitations, either by reference or by attachment thereto or both.

(5) *Standard Form 114C-1, Sale of Government Property—Special Sealed Bid Conditions.* Standard Form 114C-1, is in addition to the Standard Form 114C and is applicable only to sealed bid sales (other than term-type sales) and shall be made a part of all such sales invitations, either by reference or by attachment thereto or both.

(6) *Standard Form 114C-2, Sale of Government Property—Special Sealed Bid-Term Conditions.* Standard Form 114C-2, is applicable only to sealed bid term-type sales and is in addition to the Standard Form 114C. The form shall be made a part of all such sales invitations, either by reference or by attachment thereto, or both.

(7) *Standard Form 114C-3, Sale of Government Property—Special Spot Bid Conditions.* Standard Form 114C-3, is applicable only to spot bid sales and is in addition to the Standard Form 114C. The form shall be made a part of all sales announcements, bidders registers,

and bid cards, either by reference or by attachment thereto or both.

(8) *Standard Form 114C-4, Sale of Government Property—Special Auction Conditions.* Standard Form 114C-4, is applicable only to auction sales and is in addition to the Standard Form 114C. The form shall be made a part of all sales announcements and bidders registers, either by reference or by attachment thereto or both.

(d) *Other special conditions.* (1) Other special terms and conditions considered by a selling agency to be necessary for the particular property offered for sale and not inconsistent with those contained in the forms prescribed in this §101-45.304-8 may be incorporated in invitations for bids in which these forms are used. These additional terms and conditions should be kept to a minimum. To the extent practicable, incorporation of these special conditions should be accomplished by a special form developed by the selling agency for that purpose and so indicated on Standard Form 114, Sale of Government Property—Bid and Award. Each selling agency shall review periodically these terms and conditions that are commonly used in its agency to standardize those in general use and eliminate unnecessary additions. The agency shall periodically forward to the Commissioner, Federal Property Resources Service (General Services Administration (D), Washington, DC 20406), the additional terms and conditions desirable for inclusion in the Standard Forms.

(2) Standard Form 114, Sale of Government Property—Bid and Award, incorporates by reference Standard Form 114C and Standard Forms 114C-1 and 114C-2, as appropriate. Therefore, it is not necessary to attach such forms each time invitations for bids are issued, but an agency may elect to do so. It is essential, however, that any terms and conditions incorporated in an invitation by reference be furnished to any prospective bidder promptly on request.

(e) *Standard Form 114D, Sale of Government Property—Amendment of Invitation for Bids/Modification of Contract.* Standard Form 114D, is applicable to all sales of personal property and shall be used as required.

(1) *Amendment.* (i) If after issuance of an invitation for bids, but before the time set for opening of bids or the start of a sale, it becomes necessary to make changes to the invitation, the changes shall be accomplished by the issuance of an amendment to the invitation for bids on Standard Form 114D. The amendment shall be sent to each firm or individual to whom the invitation for bids has been furnished and shall be displayed in the bid room. In the event an amendment must be issued to either an auction or spot bid invitation for bids in which mailed-in bids are not authorized and where time does not permit distribution by mail, such amendment may be issued at the time of bidder registration.

(ii) When an invitation is canceled, bids which have been received shall be returned unopened to the bidders and a notice of cancellation sent to all prospective bidders to whom invitations for bids were issued identifying the invitation and briefly explaining the reason for the cancellation.

(2) *Supplemental agreement.* A supplemental agreement is required for a contract modification which, in accordance with the contractual provisions, cannot be accomplished by unilateral action of the Government. Such supplemental agreement must be mutually agreed to by both parties and be distributed in the same manner as the original contract. Modifications to contracts require careful consideration before issuance and the sales contracting officer should be absolutely certain that the information contained in the supplemental agreement is accurate. In addition, the sales contracting officer must satisfy himself that the contract modification is authorized and that as a result of the contract modification, the purchaser will enjoy no advantage or gain which is uncompensated, or which would not reasonably flow from the terms and conditions of the invitation for bids or the solicitation of offers out of which the original contract arose.

(f) *Standard Form 114E, Sale of Government Property—Negotiated Sales Contract.* Standard Form 114E, is applicable only to negotiated sales and is used to confirm quotations received from

Federal Property Management Regulations

§ 101-45.304-10

offerors contracted by the selling activity and constitutes the sales contract upon execution by the purchaser and by the Government. Standard Form 114E shall have attached thereto or made a part thereof by reference, Standard Form 114C, General Sale Terms and Conditions, and those additional special terms and conditions applicable only to the specific negotiation concerned.

(g) *Standard Form 114F, Sale of Government Property—Item Bid Page—Spot Bid or Auction.* Standard Form 114F, is used only when mailed-in bids are authorized in connection with a spot bid or auction sale.

(h) *Description of property for sale.* The invitation for bids shall include a listing of the property being offered for sale and each unit or line item shall be assigned a specific item number. The property should be adequately described including all factual information necessary to convey to prospective bidders an accurate, concise, and clear understanding of the property being offered. To the extent applicable, the following guideline information should be included as a part of the description:

(1) Noun name and other descriptive information expressed in understandable commercial terms.

(2) Part numbers and pertinent specifications as to sizes, type, etc.

(3) Manufacturers' name or trade name and year of manufacture.

(4) Estimated total weight or cube.

(5) Condition of property limited generally to statements of fact such as "unused" or "used." To these general statements there may be added, when known and applicable, information such as "parts missing," "wrecked," "major components removed," etc.

(6) Quantity stated in the same unit of measure as that for which bids are solicited (each, pound, ton, per lot, etc.), such units to conform with established trade practices in the industry or commodity area in which the property falls.

(7) Original acquisition cost, if known, or estimated cost (and so indicated) may be included.

(8) Location of the property; dates and time available for inspection; and name, title, and telephone number of custodian.

(i) *Removal of property.* A reasonable period of time shall be afforded successful purchasers to effect complete removal of the property and must be set forth in the invitation for bids.

[35 FR 12119, July 29, 1970, as amended at 42 FR 40853, Aug. 12, 1977; 46 FR 39592, Aug. 4, 1981; 59 FR 50697, Oct. 5, 1994]

§ 101-45.304-9 Credit.

Except as authorized in §101-45.304-12, personal property shall not be offered for sale or sold on credit without the prior approval of the Administrator of General Services or his designee. When approved, the terms and conditions of sale shall specifically provide therefor.

§ 101-45.304-10 Deposits and final payments.

(a) Whenever a bid deposit is required by the terms and conditions of the invitation for bids, the normal deposit for individual type sales shall be 20 percent of the total amount of the bid. For sales of property on an "as generated" basis during a stated period of time (referred to as term contracts), the normal deposit shall not be less than an amount which will adequately protect the Government's interest, normally 20 percent of the estimated contract price. However, the bid deposit for a term contract in excess of 1 year's duration shall not exceed 20 percent of the total price estimated for 1 year's removal of property.

(b) Whenever a bid deposit is required by the terms and conditions of the invitation for bids, such deposit shall be in U.S. currency or any form of credit instrument other than a promissory note, made payable on demand in U.S. currency, except as provided for in condition number 4 of Standard Form 114C, General Sales Terms and Conditions. Postdated credit instruments are not acceptable. Deposit bonds submitted on Standard Forms 150 and 151 (illustrated in §§101-45.4901-50 and 101-45.4901-151) may also be accepted when provided for in the invitation for bids.

(c) Irrevocable commercial letters of credit issued by a bank established in the United States, payable to the Treasurer of the United States or to the Government agency conducting the

§ 101-45.304-11

41 CFR Ch. 101 (7-1-01 Edition)

sale, may be used in lieu of the foregoing forms of deposit. Such letters shall be substantially in the format shown in §101-45.4802. General instructions relating to the preparation of letters of credit are also contained in §101-45.4803.

(d) Any draft drawn against such letter of credit shall be substantially in the format shown in §101-45.4804. The draft shall be accompanied by a transmittal letter and certification substantially in the format shown in §101-45.4805.

(e) Final payments shall be acceptable in the same forms as for bid deposits, with the exception of deposit bonds.

(f) Potential buyers shall be notified as to the exact organizational entity to the order of which the prescribed form of deposit is to be made payable. In no event shall a bid be rejected solely on the grounds that the instrument of deposit is made payable to the Treasurer of the United States when the offering specifies that it be made payable to the Government agency conducting the sale, or conversely, as the case may be.

[30 FR 2930, Mar. 6, 1965, as amended at 35 FR 12121, July 29, 1970; 42 FR 40854, Aug. 12, 1977]

§ 101-45.304-11 Deposit bonds.

(a) *Standard forms.* The following standard forms, as applicable, shall be used when a bond, in lieu of cash or other acceptable form of bid deposit, is permitted by the sales invitation.

(1) Standard Form 150, Deposit Bond—Individual Invitation, Sale of Government Personal Property. (See §101-45.4901-150.)

(2) Standard Form 151, Deposit Bond—Annual, Sale of Government Personal Property. (See §101-45.4901-151.)

(3) Standard Form 28, Affidavit of Individual Surety. (See §101-45.4901-28.)

(b) *Instructions and procedures.* (1) Comprehensive instructions for the execution and use of Standard Form 150, Deposit Bond—Individual Invitation; Standard Form 151, Deposit Bond—Annual; and Standard Form 28, Affidavit of Individual Surety, are provided on the reverse of each form. Implementing instructions shall be consistent therewith.

(2) Standard Form 151, Deposit Bond—Annual, contains the following provision:

Upon the making of an award to the principal, or within a reasonable period of time thereafter, the Government shall transmit, in writing, the following information to the surety at the above address:

(i) Name and address of the principal(s); (ii) number of the invitation for bids; (iii) name and address of the department or agency making the award; (iv) date of the award; and (v) total purchase price covered by the award. The phrase, "or within a reasonable period of time thereafter", shall, for practicable purposes, be construed to mean within 15 days following the making of the award. Optional Form 20, Notice to Surety—Deposit Bond—Annual (illustrated at §101-45.4903-20) is a form of written notice available for this purpose.

(3) In the event a bidder whose bid deposit is secured by a deposit bond attempts to withdraw his bid in violation of paragraph 3, General Sale Terms and Conditions, Standard Form 114C, and such bid is determined to be the high bid acceptable to the Government, a formal notice of award shall be issued to inform the bidder of his contractual obligations.

(4) In the event of default by a bidder whose bid deposit has been secured by a deposit bond, a notice of such default should be sent to the bidder (principal) and the surety.

[30 FR 2930, Mar. 6, 1965, as amended at 42 FR 40854, Aug. 12, 1977]

§ 101-45.304-12 Sales to State and local governments.

(a) *General.* (1) State and local governments may purchase Government personal property by:

(i) Negotiation through their State agencies for surplus property as prescribed in this §101-45.304-12;

(ii) Negotiation at fixed prices through their State agencies for surplus property as prescribed in this §101-45.304-12;

(iii) Participation in public sales of Government personal property on a competitive bid basis by having their names maintained on appropriate mailing lists.

(2) No fees or monies will be paid by the Government to State agencies for surplus property for handling these transactions. The State agencies for

Federal Property Management Regulations

§ 101-45.304-12

surplus property may impose a fee on purchasers for costs incurred.

(3) When sales are made to State and local governments, the requirements for bid deposits and payments for property prior to removal shall be waived. However, payment must be made within 30 calendar days after purchase. If payment is not made within this time-frame, simple interest may be charged at the rate which has been established by the Secretary of the Treasury as provided in section 12 of the Contract Disputes Act of 1978 (Pub. L. 95-563), from the date of first written demand until paid.

(b) *Definitions.* The following terms shall have the meanings set forth in this §101-45.304-12:

(1) *Estimated fair market value.* The selling agency's best estimate of what the property would be sold for if offered for public sale.

(2) *State agency.* *State agency* means the agency in each State designated under State law as responsible for the distribution within the State of all donations of surplus property to public agencies and eligible nonprofit tax-exempt activities. This agency will also be responsible for administering the program in their State whereby eligible activities may purchase Government personal property by negotiation or negotiation at fixed prices.

(3) *State and local government.* A State, territory, possession, political subdivision thereof, or tax-supported agency therein.

(4) *Want lists.* Lists of items, submitted by State agencies to selling agencies, of personal property State and local governments desire to purchase by negotiation or fixed prices.

(c) *Submission of State agency requests for property.* State agency requests to selling agencies for purchasing property by negotiation and negotiation at fixed prices shall include, at the minimum, the following information for each type of property requested:

(1) Name, title, address, and telephone number of official person(s) authorized to obligate funds and enter into an agreement to purchase.

(2) Geographical area(s) within which they would be willing to inspect and purchase property;

(3) Complete description of each item desired; i.e., electric typewriter not office equipment, dump truck not vehicular equipment, compact sedan not sedan;

(4) Number of days the request should be maintained on the "want list" pending availability, not to exceed 60 days (selling agencies may extend the expiration date when property is subject to seasonal availability); and

(5) Minimum poorest acceptable condition; i.e., good (usable without repairs), fair (repairable), poor (extensive repairs required).

(d) *Nonwithdrawal.* Property listed in invitation for bids that has been offered for sale to the general public at the time requests are received from State agencies will not be withdrawn from sale under this §101-45.304-12.

(e) *Negotiated sales.* Personal property may be sold by negotiation to State and local governments through their State agencies subject to obtaining such competition as is feasible under the circumstances provided that the estimated fair market value and other satisfactory terms of disposal are obtained (see §101-45.304-2(a)(1)(iv) and §101-46.303(b)(1)). When two or more State agencies have indicated a desire to purchase the same item, quotations should be obtained from such interested parties. When only one State agency wants the property, and no further competition is feasible under the circumstances and all other conditions for negotiation have been met, the sale may be made.

(1) With the exception of items having an estimated fair market value of less than \$100, selling agencies may honor requests by State agencies for State and local governments to purchase property by negotiation prior to offering the property for public sale.

(2) When requested property is available for purchase, the selling agency shall take appropriate action to notify the State agency that the property is available for sale and, when appropriate, consummate the sale in accordance with this §101-45.304-12(e).

(3) When requested property is not presently available for purchase, selling agencies shall:

(i) Establish a "want list" system reflecting State agencies' requests for

§ 101-45.305

property being offered by negotiated sale.

(ii) Screen property reported for sales action against established "want lists."

(4) When a desired item becomes available for sale, the interested State agency(s) shall be advised of:

(i) The complete item description;

(ii) The condition of the item;

(iii) The item location;

(iv) Full information concerning inspection; and

(v) The estimated fair market value when only one State agency is involved.

(5) A reasonable period of time not to exceed 15 days shall be given the State agency to indicate its desire to purchase the property.

(6) Satisfactory arrangements must be made with State agencies for payment, pickup, handling, and transportation charges, when necessary. (See §101-45.304-12(a)(3) for timeframes for payments.)

(f) Negotiated sales at fixed prices. Property approved to be sold at fixed prices may be offered through State agencies to State and local governments (see §101-45.304-2(b)) at fixed prices prior to public sale.

(1) When property is available at the time of request, the selling agency shall notify the requesting State agency and, when appropriate, consummate the sale in accordance with this §101-45.304-12(f).

(2) When requested property is not presently available for purchase, selling agencies shall:

(i) Establish a "want list" system reflecting State agencies' requests for property being sold at fixed prices, to include approved exchange/sale categories of property (see §101-46.303(b)).

(ii) Screen property to be offered by fixed prices against established "want lists."

(3) When requested property becomes available, interested State agencies shall be advised of:

(i) The complete item description;

(ii) The condition of the item;

(iii) The item location;

(iv) Full information concerning inspection; and

(v) The fixed price established for the item.

41 CFR Ch. 101 (7-1-01 Edition)

(4) A reasonable period of time not to exceed 15 days shall be given the State agency(s) to indicate its desire to purchase the item. However, when more than one State agency has indicated interest in the item, the sale will be on a "first-come, first-served" basis.

[55 FR 17610, Apr. 26, 1990]

§ 101-45.305 [Reserved]

§ 101-45.306 Contractor inventory.

Except for contractor inventory where retention by the contractor is authorized by the terms of the contract, and after compliance with the applicable requirements of §101-45.310, contractor inventory shall be sold in the same manner as surplus personal property.

[53 FR 16121, May 5, 1988]

§ 101-45.307 Proceeds from sales.

Section 201(c) of the Act, authorizes any executive agency to apply the proceeds from sale of exchange/sale property in whole or in part payment for similar items acquired for replacement purposes. Section 204(a) of the Act requires, except in certain specified instances, that proceeds from sale of surplus personal property shall be covered into the Treasury as miscellaneous receipts. The exceptions are where property sold was originally acquired by funds not appropriated from the general fund of the Treasury, or appropriated therefrom and by law reimbursable from assessments, taxes, or other revenues; and where any contract entered in to by any executive agency or any subcontract under such contract authorizes the proceeds of any sale of contractor inventory to be credited to the price or cost of the work covered by such contract or subcontract. In these cases, the gross proceeds from the sale of such property will be deposited by the selling agency or by contractor or subcontractor to the reimbursable fund or appropriation or paid to the Federal agency accountable for the property. In all other cases, the gross proceeds from the sale of property will be deposited by the selling

Federal Property Management Regulations

§ 101-45.309-3

agency to the Treasury as miscellaneous receipts. Therefore, it is essential that the Standard Form 120, Report of Excess Personal Property, or Standard Form 126, Report of Personal Property for Sale, be properly completed to identify the appropriate appropriation or fund symbol, title, and station deposit symbol or station account number, or other manner in which payment is desired.

[31 FR 5001, Mar. 26, 1966]

§ 101-45.308 [Reserved]

§ 101-45.309 Special classes of property.

§ 101-45.309-1 Agricultural commodities.

(a) *Disposal by holding agencies.* Surplus agricultural commodities, surplus foods processed from agricultural commodities, and surplus cotton or woolen goods may be disposed of in accordance with this part 101-45, without reference to the Department of Agriculture, in the following instances:

(1) Where the quantity of such commodity or product in any one location has an acquisition cost not in excess of \$5,000.

(2) Where such commodity or product must be disposed of immediately to prevent spoilage.

(3) Where the quantity to be sold during any month has an acquisition cost not in excess of:

(i) Raw cotton, wheat and other grains, flour, leaf tobacco, and cotton or woolen goods—\$300,000.

(ii) Meat, poultry and poultry products, peanuts, and other fats and oils—\$50,000.

(iii) All other agricultural commodities and foods processed from agricultural commodities—\$25,000.

(b) *Required references to the Department of Agriculture.* With respect to quantities of surplus agricultural commodities, surplus foods processed from agricultural commodities, and surplus cotton or woolen goods, in excess of the amounts specified in this § 101-45.309-1, holding agencies shall obtain from the Agriculture Stabilization and Conservation Service, Department of Agriculture:

(1) A determination, with appropriate instructions, that the commodities or products should be transferred to the Department of Agriculture for disposition as provided by section 203(h) of the Act. Holding agencies accordingly may execute transfers without charge to the Department of Agriculture; or

(2) A statement setting forth the conditions and prices which should be used in the disposition of the commodities or products.

[30 FR 2930, Mar. 6, 1965, as amended at 43 FR 26579, June 21, 1978]

§ 101-45.309-2 Hazardous materials.

In addition to the requirements of this part 101-45, the sale of hazardous materials shall be accomplished in accordance with the provisions of part 101-42.

[57 FR 39137, Aug. 28, 1992]

§ 101-45.309-3 Demilitarization and decontamination.

(a) Dangerous material shall not be disposed of pursuant to this part 101-45 without first being demilitarized or decontaminated when a duly authorized official of the executive agency concerned determines this action to be in the interest of public health, safety, or security. This may include rendering the property innocuous, stripping from it any confidential or secret characteristics, or otherwise making it unfit for further use.

(b) Demilitarization or decontamination of property to be donated to public bodies pursuant to subpart 101-44.7 shall be accomplished in a manner so as to preserve so far as possible any civilian utility or commercial value of the property.

(c) Except for those sales otherwise authorized by § 101-45.309-2 or other statutes, and for specialized sales authorized by the Secretary of Defense, U.S. Munitions List items identified as requiring demilitarization shall not be reported for public sale without first being demilitarized or requiring demilitarization to be a part of the terms and conditions of sale. GSA may refer technical questions on demilitarization to the Department of Defense for advice.

[44 FR 27393, May 10, 1979]

§ 101-45.309-4

41 CFR Ch. 101 (7-1-01 Edition)

§ 101-45.309-4 [Reserved]

§ 101-45.309-5 Garbage.

All invitations to bid for removal of garbage from property occupied or controlled by the Federal Government, unless specifically requiring destruction by incineration, shall state that all bidders must comply with basic requirements for sterilization prescribed by the Animal Disease Eradication Division, Bureau of Animal Industry, Department of Agriculture. In the interest of uniformity, the following provision shall be included in all invitations to bid where garbage collected may, under any circumstances, be fed to livestock or poultry:

Prior to award the bidder agrees to furnish a certification from an Animal Disease Eradication Division representative of the U.S. Department of Agriculture, that he possesses adequate and approved garbage sterilization equipment. In the event of an acceptance of his bid by the Government, the bidder warrants that all garbage received under the contract will be sterilized not less than 30 minutes at 212 °F. before being fed to livestock or poultry. The bidder agrees to permit representatives of the Animal Disease Eradication Division of the U.S. Department of Agriculture to make inspections at any time without prior arrangements to determine that the garbage is heat treated in accordance with the provision.

§ 101-45.309-6—101-45.309-7 [Reserved]

§ 101-45.309-8 Bedding and upholstered furniture.

(a) Requirements under State law placed on the purchase and resale of used bedding and upholstered furniture vary from State to State. Some of the restrictions are:

(1) Requirement for sterilization and disinfection of used or second-hand bedding; (2) requirement for an annual license or registration fee as a supply dealer or renovator; (3) option of using stamps or a stamp exemption permit; and (4) requirement for the manufacturer's or vendor's name and address on the tag. Purchasers of Government surplus bedding and upholstered furniture normally are advised to comply with applicable State laws relating to the resale or reuse of such items.

(b) Procedures and instructions are provided herein for selling agencies to

assist State health agencies by advising purchasers of surplus bedding and upholstered furniture to comply with State sanitation standards.

(c) The following terms have the meaning set forth in this § 101-45.309-8:

(1) *Bedding.* Any box spring, comforter, cushion, davenport, hammock pad, lounge, mattress, mattress pad, mattress protector, pillow, quilted pad, sleeping bag, sofa, studio couch, or upholstered spring bed used for sleeping, resting, or reclining purposes.

(2) *Upholstered furniture.* Any article of furniture, wholly or partially stuffed or filled with any concealed material, which is intended for use for sitting, resting, or reclining purposes.

(3) *Filling material.* African fibre, bamboo, cotton, down, excelsior, feathers, felted cotton, fibre, foam rubber, hair, husks, jute, kapok, Louisiana tree moss, sea moss, shoddy, wool, or any other soft material.

(d) Surplus bedding and upholstered furniture which are considered to be detrimental to public health or safety shall be destroyed in accordance with the provisions of subpart 101-45.5.

(e) Surplus bedding and upholstered furniture will be sold in accordance with § 101-45.304 and this § 101-45.309-8.

(f) Sales of surplus bedding material and upholstered furniture shall be processed as follows:

(1) The invitation for bids shall include information advising purchasers of surplus bedding and upholstered furniture to comply with the State laws pertaining to sterilization, resale, and reuse of such items and filling materials as required by State laws.

(2) The invitation for bids shall contain a notice to bidders substantially as follows:

Mattresses, Bedding, or Upholstered Furniture. For any mattresses, bedding, or upholstered furniture offered in this invitation, the purchaser is advised to procure and affix tags, labels, or stamps required by law or otherwise to comply with the State laws pertaining to sterilization, resale, and reuse of such items and filling material as required by State law.

(3) Selling agencies shall be required to provide the State health agency for the State in which a successful bidder maintains its business, with a written notice of such sale to include the name

Federal Property Management Regulations

§ 101-45.309-12

and address of the purchaser and the types, quantities, and locations of the articles sold. A copy of the award document or similar notification would serve the purpose.

(4) A list of State health agencies to receive information on sales of surplus bedding and upholstered furniture is provided in §101-45.4808.

[34 FR 8164, May 24, 1969, as amended at 42 FR 40854, Aug. 12, 1977]

§ 101-45.309-9 Gold.

(a) Gold will be sold in accordance with §101-45.304 and this §101-45.309-9.

(b) Sales of gold shall be processed to:

(1) Use the sealed bid method of sale;

(2) Require a 20 percent bid deposit;

(3) Certify all forms of bid deposit and payments; and

(4) Include in the invitation for bids only gold and such other precious and semiprecious materials as may be available for sale at that time.

(c) Each agency generating scrap gold and also having a continuing need for fine gold may arrange for the acceptance of scrap gold for fine gold with a private contractor or the Defense Logistics Agency in accordance with §101-10.1004, Recovery and use of precious metals through the DOD Precious Metals Recovery Program.

[40 FR 33216, Aug. 7, 1975, as amended at 53 FR 16122, May 5, 1988]

§ 101-45.309-10 Safes and locking file cabinets.

Safes and locking file cabinets shall not be accepted for sale in a locked condition, and no safe or locking file cabinet shall be offered for sale pursuant to this part 101-45 unless empty and unlocked. When available, combinations should be taped and/or keys strapped to the outside front of the safe or cabinet.

[41 FR 5097, Feb. 4, 1976]

§ 101-45.309-11 [Reserved]

§ 101-45.309-12 Vehicle reconditioning.

(a) For the purpose of this section, *vehicle reconditioning* means restoring or improving the appearance of any motorized passenger or cargo vehicle designed primarily for highway use that is to be disposed of through sur-

plus or exchange/sale procedures to the general public.

(b) To produce the maximum net proceeds, holding agencies shall determine, prior to sale, the appropriate level of reconditioning commensurate with the estimated fair market value of each vehicle scheduled for sale.

(c) Holding agencies shall arrange for the reconditioning to be accomplished just prior to the dates scheduled for public inspection and sale.

(d) For all motor vehicles above salvage condition or value, the minimum level of reconditioning required is as follows:

(1) *Driver and passenger compartment.*

(i) Remove debris; (ii) vacuum floors and seats; (iii) clean dashboard, instrument panel, armrests, door panels, and rear shelf; (iv) remove Government stickers or decals without marring surface; (v) clean ashtrays and glove compartment; and (vi) wash windows.

(2) *Trunk.* (i) Remove debris; (ii) vacuum; and (iii) position spare tire and tools.

(3) *Engine compartment.* (i) Remove debris; (ii) replenish lubricants and coolant to required levels and replace missing caps/covers; and (iii) charge battery, if necessary.

(4) *Exterior.* (i) Remove Government stickers or decals without marring paint finish; (ii) wash exterior, including glass, door jambs, tires, and wheel rims/covers; and (iii) inflate tires to recommended pressure.

(e) Additional reconditioning of selected motor vehicles should be considered when such action is expected to substantially improve the return on the sale of a vehicle. Generally, a return of \$2.00 for each dollar invested should be estimated to justify additional reconditioning. Additional reconditioning should include some or all of the following:

(1) *Driver and passenger compartment.*

(i) Shampoo seats, dashboard, headliner, door panels, and floor covering; (ii) spray-dye floor carpets and mats; (iii) polish where appropriate; (iv) apply vinyl/rubber reconditioners where appropriate; and (v) replace missing knobs, nameplates, and light lenses and/or bulbs.

(2) *Trunk.* (i) Wash interior surface; and (ii) Spray-dye mats.

(3) *Engine compartment.* (i) Clean major surface areas (air cleaner cover, battery, etc.); (ii) wash or steam clean, when necessary; (iii) replace air and fuel filters; and (iv) make minor adjustments and/or replacements to engine systems (electrical, fuel, cooling, etc.) to ensure that the vehicle will start and idle correctly during inspection by prospective purchasers.

(4) *Exterior.* (i) Rotate tires, including the spare, to ensure that the best tires are displayed on the vehicle. Properly inflate, clean, and apply rubber conditioner or black tire paint to all tires; (ii) wash and blacken wheel splash shields; (iii) apply touch-up paint to nicks and scratches; (iv) wax and polish; (v) replace missing or damaged molding, nameplates, lenses, caps, mirrors, antennas, and wheel covers; (vi) repaint exterior of vehicle to original factory color if scrapes, dings, etc., are excessive; (vii) repair minor body damage; (viii) apply decorative molding and/or striping to add eye appeal; and (ix) obtain State safety and/or emission control inspections, if required.

(f) Reconditioning, when possible, should be accomplished no earlier than the calendar week prior to the scheduled sale date.

(g) Agencies should contact the nearest GSA Federal Supply Service Bureau office for information regarding the availability of reconditioning services.

(h) The expense of reconditioning is the responsibility of the holding agency.

[55 FR 19737, May 11, 1990]

§ 101-45.309-13 All terrain vehicles.

(a) Three-wheeled all terrain vehicles (ATVs) may be offered for public sale only after they have been mutilated in a manner to prevent operational use.

(b) Four-wheeled ATVs no longer needed by the Government can be exchanged with a dealer under the provisions of §101-46.302. If the unit cannot be exchanged, four-wheeled ATVs may be offered for public sale only after they have been mutilated in a manner to prevent operational use.

[57 FR 34253, Aug. 4, 1992]

§ 101-45.310 Antitrust laws.

Whenever an award is proposed to any private interest of personal property with an estimated fair market value of \$3,000,000 or more, or of a patent, process, technique, or invention, irrespective of cost, the selling agency shall promptly notify the Attorney General and the Administrator of General Services, simultaneously, of the proposed disposal and the probable terms and conditions thereof. Upon request by the Attorney General, the agency shall furnish or cause to be furnished to the Attorney General such additional information as the agency may possess concerning the proposed disposition. The Attorney General will advise the agency and the Administrator of General Services within a reasonable time, in no event to exceed 60 days after receipt of such notification, whether, so far as the he can determine, the proposed disposition would tend to create or maintain a situation inconsistent with the antitrust laws. The agency shall not effect disposition until it has received such advice. The agency shall include in the notification transmitted to the Attorney General and the Administrator of General Services, the following information:

(a) Location and description of property (specifying the tonnage, if scrap).

(b) Proposed sale price of property (explaining the circumstances, if proposed purchaser was not highest bidder).

(c) Acquisition cost of property to Government.

(d) Manner of sale, indicating whether by:

(1) Sealed bid (specifying numbers of purchasers solicited and bids received);

(2) Auction or spot bid (stating how sale was advertised); or

(3) Negotiation (explaining why property was not offered for sale by competitive bid).

(e) Proposed purchaser's name, address, and trade name (if any) under which it is doing business.

(f) If a corporation, give name of State and date of incorporation, and name and address of:

(1) Each holder of 25 percent or more of the corporate stock;

(2) Each subsidiary; and

Federal Property Management Regulations

§ 101-45.313-3

(3) Each company under common control with proposed purchaser.

(g) If a partnership, give:

(1) Name and address of each partner;

(2) Other business connections of each partner.

(h) Nature of proposed purchaser's business, indicating whether its scope is local, statewide, regional, or national.

(i) Estimated dollar sales volume of proposed purchaser (as of latest calendar or fiscal year).

(j) Estimated net worth of proposed purchaser.

(k) Proposed purchaser's intended use of property.

[30 FR 2930, Mar. 6, 1965, as amended at 54 FR 38676, Sept. 20, 1989]

§ 101-45.311 Assistance in controlling unauthorized transport of property.

In order to help alleviate the problems associated with unauthorized transport of property sold by the Government, and to assist the Interstate Commerce Commission in improving control of transportation for hire, the following information shall be made known to all purchasers and shall be included as a "Special Instruction to Bidders" in all formal invitations requesting bids or offers for the sale of personal property:

Attention is invited to the fact that the Interstate Commerce Act makes it unlawful for anyone other than those duly authorized pursuant to that Act to transport this property in interstate commerce for hire. Anyone aiding or abetting in such violation is a principal in committing the offense (49 U.S.C. 301-327 and 18 U.S.C. 2).

§ 101-45.312 [Reserved]

§ 101-45.313 Procedures and forms concerning contingent or other fees for soliciting or securing contracts.

§ 101-45.313-1 Purpose.

For the purpose of promoting uniformity among executive agencies with respect to the required use of the "covenant against contingent fees" and with respect to the procedure for obtaining information concerning contingent or other fees paid by contractors for soliciting and securing Government contracts, the Department of Defense and GSA have developed cooperatively

and agreed upon the required use of the "covenant against contingent fees" and the form, procedure, principles, and standards described in this section.

§ 101-45.313-2 Objectives and methods.

(a) *Objectives.* The requirements of § 101-45.313 have as their objective the prevention of improper influence in connection with the obtaining of Government contracts, the elimination of arrangements which encourage the payment of inequitable and exorbitant fees bearing no reasonable relationship to the services actually performed, and prevention of the reduction in return to the Government which inevitably results therefrom. Improper influence means influence, direct or indirect, which induces or intends to induce consideration or action by any employee or officer of the United States with respect to any Government contract on any basis other than the merits of the matter.

(b) *Methods.* The methods used to achieve the above objectives stated in paragraph (a) of this section are the requirement for disclosure of the details of arrangements under which agents represent concerns in obtaining Government contracts, and the prohibiting, by use of the covenant against contingent fees, of certain types of contractor-agent arrangements. The Criminal Code will apply in any case involving actual criminal conduct.

§ 101-45.313-3 Representation and covenant.

(a) *Representation.* Except as provided in § 101-45.313-7, each selling agency shall inquire of and secure a written representation from prospective purchasers as to whether they have employed or retained any company or person (other than a full-time employee working solely for the prospective purchaser) to solicit or secure the contract, and shall secure a written agreement to furnish information relating thereto as required by the sales contracting officer. The form of such representation shall be that contained in Standard Form 114, Sale of Government Property—Bid and Award (illustrated in § 101-45.4901-114).

(b) *Covenant*. Selling agencies shall include in every negotiated or advertised contract for the sale of Government-owned personal property the "covenant against contingent fees" as contained in the Standard Form 114C, General Sale Terms and Conditions (illustrated in § 101-45.4901-114C).

[42 FR 40854, Aug. 12, 1977]

§ 101-45.313-4 General principles and standards applicable to the covenant.

(a) *Use of principles and standards*. The principles and standards set forth in this § 101-45.313-4 are intended to be used as a guide in the negotiation, awarding, administration, or enforcement of Government contracts.

(b) *Contingent character of the fee*. Any fee whether called commission, percentage, brokerage, or contingent fee, or otherwise denominated, is within the purview of the covenant if, in fact, any portion thereof is dependent upon success in obtaining or securing the Government contract or contracts involved. The fact, however, that a fee of a contingent nature is involved does not preclude a relationship which qualifies under the exceptions to the prohibition of the covenant.

(c) *Exceptions to the prohibition*. There are excepted from the prohibition of the covenant "bona fide employees" and "bona fide established commercial or selling agencies maintained by the contractor for the purpose of securing business."

(d) *Bona fide employee*. (1) The term *bona fide employee*, for the purpose of the exception to the prohibition of the covenant, means an individual (including a corporate officer) employed by a concern in good faith to devote his full time to such concern and no other concern and over whom the concern has the right to exercise supervision and control as to time, place, and manner of performance of work.

NOTE: It is recognized that a concern, especially a small business concern, may employ an individual who represents other concerns. The factors set forth in § 101-45.313-4(e)(2), except (iv), shall be applied to determine whether such an individual comes within the exception to the prohibition of the covenant.

(2) The hiring must contemplate some continuity and it may not be re-

lated only to the obtaining of one or more specific Government contracts.

(3) An employee is not "bona fide" who seeks to obtain any Government contract or contracts for his employer through the use of improper influence or who holds himself out as being able to obtain any Government contract or contracts through improper influence.

(4) A person may be a bona fide employee whether his compensation is on a fixed salary basis, or when customary in the trade, on a percentage, commission, or other contingent basis or a combination of the foregoing.

(e) *Bona fide established commercial or selling agency maintained by the contractor for the purpose of securing business*. (1) An agency or agent is not "bona fide" which seeks to obtain any Government contract or contracts for its principals through the use of improper influence or which holds itself out as being able to obtain any Government contract or contracts through improper influence.

(2) In determining whether an agency is a "bona fide established commercial or selling agency maintained by the contractor for the purpose of securing business," the factors set forth below shall be considered. They are necessarily incapable of exact measurement or precise definition and it is neither possible nor desirable to prescribe the relative weight to be given any single factor as against any other factor or as against all other factors. The conclusions to be reached in a given case will necessarily depend upon a careful evaluation of the agreement and other attendant facts and circumstances.

(i) The fees charged should not be inequitable and exorbitant in relation to the services actually rendered. That is, the compensation should be commensurate with the nature and extent of the services and should not be excessive as compared with the fees customarily allowed in the trade concerned for similar services related to commercial (non-Government) business. In evaluating reasonableness of the fee, there should be considered services of the agent other than actual solicitation, as for example, technical, consultant, or managerial services, and assistance in the procurement of essential personnel, facilities, equipment, materials, or

Federal Property Management Regulations

§ 101-45.313-7

subcontractors for performance of the contract.

(ii) The selling agency should have adequate knowledge of the products and the business of the concern represented, as well as other qualifications necessary to sell the products or services on their merits.

(iii) There should ordinarily be a continuity of relationship between the contractor and the agency. The fact that the agency has represented the contractor over a considerable period of time is a factor for favorable consideration. It is not intended, however, to disqualify newly established contractor-agency relationships where a continuing relationship is contemplated by the parties.

(iv) It should appear that the agency is an established concern. The agency may be either one which has been in business for a considerable period of time or a new agency which is a presently going concern and which is likely to continue in business as a commercial or selling agency in the future. The business of the agency should be conducted in the agency name and characterized by the customary indicia of the conduct of a regular business.

(v) The fact that a selling agency confines its selling activities to the field of Government contracts does not, in and of itself, disqualify it under the covenant. The fact, however, that the selling agency is employed to secure business generally, that is, to represent the concern in connection with sales to the Government, as well as regular commercial sales to non-Government activities, is a factor entitled to favorable consideration in evaluating the case as one coming within the authorized exception. Arrangements confined, however, to obtaining Government contracts, particularly those involving a selling agency organized immediately prior to or during periods of expanded procurement resulting from conditions of national emergency, must be closely scrutinized.

(f) *Fees for "information."* Contingent fees paid for "information" leading to obtaining a Government contract or contracts are included in the prohibition and, accordingly, are in breach of the covenant unless the agent qualified under the exception as a bona fide em-

ployee or a bona fide established commercial or selling agency maintained by the contractor for the purpose of securing business.

§ 101-45.313-5 Standard Form 119, Contractor's Statement of Contingent or Other Fees.

Pursuant to the Act and in furtherance of the purpose and objectives stated in sections 1 and 3 thereof, Standard Form 119, shall be used in accordance with the provisions of this § 101-45.313.

§ 101-45.313-6 Use of Standard Form 119, Contractor's Statement of Contingent or Other Fees.

(a) *Required use.* Except as provided in § 101-45.313-7, Standard Form 119 shall be used, without deviation, whenever either part of the inquiry provided for in § 101-45.313-3(a) with respect to contingent fees is answered in the affirmative. The form shall be used also, without deviation, in any other case where an agency desires to obtain such information. When, after use of the form, further information is required, it may be obtained in any appropriate manner. Submission of the form shall be required, normally, only of successful bidders and contractors.

(b) *Statement in lieu of form.* Any bidder who has previously furnished a Standard Form 119 to the office issuing the invitation or negotiating the contract may be permitted to accompany his bid with, or submit in connection with the proposed contract, a signed statement indicating when such completed form was previously furnished, identifying by number the previous invitation or contract in connection with which such form was submitted; and representing that the statements in such previously furnished form are applicable to such subsequent bid or contract. In such case, submission of an additional completed Standard Form 119 need not be required.

§ 101-45.313-7 Exceptions.

The inquiry and agreement specified in § 101-45.313-3(a) need not be made and submission of Standard Form 119 need not be requested in connection with any of the following:

§ 101-45.313-8

41 CFR Ch. 101 (7-1-01 Edition)

(a) Any advertised contract in which the aggregate amount involved does not exceed \$25,000.

(b) Any negotiated contract in which the aggregate amount involved does not exceed \$5,000.

(c) Contracts to be made in foreign countries.

(d) Any other contracts, individually or by class, of the Department of Defense, designated by the Secretary, Under Secretary, or Assistant Secretary of a military department. (Reports of any such exceptions shall be filed promptly with the Administrator of General Services.)

[30 FR 2930, Mar. 6, 1965, as amended at 35 FR 12121, July 29, 1970]

§ 101-45.313-8 Enforcement.

(a) *Failure or refusal to furnish representation and agreement.* Each selling agency shall take the necessary steps to assure that the indicated successful bidder or proposed contractor has furnished a representation (negative or affirmative) and agreement as prescribed in § 101-45.313-3.

(1) If the indicated successful bidder makes such representation in the negative such representation may be accepted and award made or offer accepted in accordance with established procedure.

(2) If the indicated successful bidder or proposed contractor makes such representation in the affirmative, a completed Standard Form 119 shall be requested from the bidder or proposed contractor. In the case of formal advertising, the making of an award in accordance with established procedure need not be delayed pending receipt of the form. In the case of negotiation, if the proposed contractor makes such representation in the affirmative, he shall be required to file a completed Standard Form 119 prior to acceptance of the offer or execution of the contract unless the head of the executive agency (including for this purpose, any military department) concerned, or his authorized representative, considers that the interest of the Government will be prejudiced by the suspension of negotiations pending receipt and consideration of an executed Standard Form 119.

(3) If the indicated successful bidder or proposed contractor fails to furnish the representation and agreement, such failure shall be considered a minor informality and, prior to award, such bidder or proposed contractor shall be afforded a further opportunity to furnish such representation and agreement. A refusal or failure to furnish such representation and agreement, after such opportunity has been afforded, shall require rejection of the bid or offer.

(b) *Failure or refusal to furnish Standard Form 119.* If the successful bidder or contractor, upon request, refuses or fails to furnish a completed Standard Form 119, or a statement in lieu thereof as provided in § 101-45.313-6, the selling agency concerned shall take one or more of the following actions, or other action, as may be appropriate:

(1) If an award has not been made or offer accepted, determine whether the bid or offer should be rejected.

(2) If the contract has been awarded or the offer accepted, determine what action shall be taken, such as making an independent investigation or considering the eligibility of the contractor as a future contractor in accordance with established procedure.

(c) *Misrepresentations or violations of the covenant against contingent fees.* In case of misrepresentation, or violation or breach of the covenant against contingent fees, or some other relevant impropriety, the selling agency concerned shall take one or more of the following actions, or other action, as may be appropriate:

(1) If an award has not been made, or offer has not been accepted, determine whether the bid or offer should be rejected.

(2) If an award has been made or offer has been accepted, take action to enforce the covenant in accordance with its terms, that is, as the best interests of the Government may appear, annul the contract without liability or recover the amount of the fee involved.

(3) Consider the future eligibility as a contractor of the bidder or contractor in accordance with established procedure.

(4) Determine whether the case should be referred to the Department

Federal Property Management Regulations

§ 101-45.318

of Justice in accordance with established procedure with respect to determining matters of fraud or criminal conduct.

§ 101-45.313-9 Preservation of records.

Selling agencies shall preserve, for enforcement or report purposes, at least one executed copy of any representation and completed Standard Form 119, together with a record of any other pertinent data, including data as to action taken.

§ 101-45.314 Federal excise taxes.

Federal manufacturers' and retailers' excise taxes are not applicable to the sale or other disposal by the Government of personal property or the disposal of contractor inventory. Federal manufacturers' excise taxes do not apply to subsequent sales, including uses, by purchasers of Government property and contractor inventory. Federal retailers' excise taxes apply to subsequent sales, but not to subsequent uses by the purchasers unless the subsequent sale is made for resale and a certificate of resale is obtained. The foregoing does not apply to gasoline, and holding agencies shall make appropriate arrangements with the Internal Revenue Service with respect to the disposal thereof. Questions relating to the applicability of Federal excise taxes arising from the disposal of property or contractor inventory should be referred to the Internal Revenue Service.

§ 101-45.315 Equal Opportunity clause in contracts.

The Equal Opportunity clause prescribed by Executive Order 11246 of September 24, 1965 (30 FR 12319, 12935) (as amended by Executive Order 11375 of October 13, 1967 (32 FR 14303)), as set forth in §101-45.4807, shall be included in all contracts for the sale of personal property when the contract exceeds \$10,000, and an appreciable amount of work by the purchaser required by or for the Government is involved. When a sale is planned and the probability exists that the foregoing conditions will be present, the Equal Opportunity clause shall be included in the contract

provisions of the invitation as a special condition of sale.

[42 FR 40854, Aug. 12, 1977]

§ 101-45.316 [Reserved]

§ 101-45.317 Noncollusive bids and proposals.

(a) Condition No. 20 of the General Sale Terms and Conditions, Standard Form 114C, contains the certification of independent price determination. This condition is applicable to all invitations for bids and requests for proposals or quotations providing for the sale of personal property, except fixed price sale under section 203(e)(5) of the Act.

(b) The authority to make determinations described in paragraph (d) of Condition No. 20 of the General Sale Terms and Conditions, Standard Form 114C, shall not be delegated to an official below the level of the head of a selling activity of the agency.

(c) Where a certification is suspected of being false or there is an indication of collusion, the matter shall be referred to the Department of Justice as provided in §101-45.107-1.

[31 FR 9542, July 14, 1966, as amended at 35 FR 12121, July 29, 1970]

§ 101-45.318 Identical bids.

In addition to complying with the requirements of §§101-45.316 and 101-45.317, when an invitation for bids for the sale of personal property results in the submission of identical bids, consideration shall be given to whether adequate prime competition was obtained. Whether there is adequate price competition for a given sale is a matter of judgment to be based on the circumstances of the sale. If the circumstances do not permit a reasonable determination that the price competition was adequate, the sale should be resolicited.

[36 FR 12297, June 30, 1971]

Subpart 101-45.4—Contract Disputes

SOURCE: 59 FR 60561, Nov. 25, 1994, unless otherwise noted.

§ 101-45.400

41 CFR Ch. 101 (7-1-01 Edition)

§ 101-45.400 Scope of subpart.

This subpart provides guidance regarding contract claims and appeals relating to contracts for the sale of personal property under the Contract Disputes Act of 1978, as amended, (41 U.S.C. 601-613). Contracting agencies should seek guidance from the Contract Disputes Act (the Act) and Federal Acquisition Regulation (FAR) 48 CFR Part 33. The Act applies to all contracts entered into by executive agencies for the sale of personal property, except the following:

(a) Contracts with a foreign government or agency of that government when the agency head determines that application of the Act to the contract would not be in the public interest,

(b) Contracts with an international organization or a subsidiary body of that organization, if the agency head determines that the application of the Act to the contract would not be in the public interest, and

(c) Contracts of the Tennessee Valley Authority unless such contracts contain a disputes clause requiring dispute resolution via an administrative process.

§ 101-45.401 The disputes clause.

The disputes clause contained at 48 CFR 52.233-1 must be included in all solicitations and contracts for the sale of personal property unless the exceptions in § 101-45.400 apply.

§ 101-45.402 Alternative disputes resolution.

The Government's policy is to try to resolve all contractual issues in controversy by mutual agreement at the contracting officer's level. Agencies are encouraged to use alternative dispute resolution (ADR) procedures to the maximum extent practicable in accordance with the authority and the requirements of the Administrative Disputes Resolution Act (Pub. L. 101-522) and agency policies.

Subpart 101-45.5 [Reserved]

Subpart 101-45.6—Debarred, Suspended, and Ineligible Contractors

§ 101-45.600 Scope of subpart.

This subpart prescribes policies and procedures governing the debarment or suspension of contractors for contracts involving the sale by the Government of personal property.

[50 FR 41145, Oct. 9, 1985]

§ 101-45.601 Policy.

(a) Agencies shall solicit offers from, award contracts to, and consent to subcontracts only with responsible contractors, as defined by Federal Acquisition Regulation (FAR) 9.104-1.

(b) The policies, procedures, and requirements of FAR subpart 9.4 are incorporated by reference and made applicable to contracts for, and to contractors who engage in the purchase of Federal personal property.

(c) The debarment or suspension of a contractor from the purchase of Federal personal property has Governmentwide effect and precludes any agency from entering into a contract for purchase of personal property with that contractor unless the agency's head or a designee responsible for the disposal action determines that there is a compelling reason for such action. (See FAR 9.405(a).)

(d) When the debarring/suspending official has authority to debar/suspend contractors from both contracts for the purchase of Federal personal property pursuant to FPMR 101-45.6 and acquisition contracts pursuant to FAR 9.4, that official shall consider simultaneously debarring/suspending the contractor from the purchase of Federal personal property and the award of acquisition contracts. When debarring/suspending a contractor from the purchase of Federal personal property and the award for acquisition contracts, the debarment/suspension notice shall so indicate and the appropriate FPMR and FAR citations shall be included.

[50 FR 41145, Oct. 9, 1985]

Federal Property Management Regulations

§ 101-45.703-2

§ 101-45.602 Listing debarred or suspended contractors.

(a) Contractors which have been debarred or suspended by agency debarring/suspending officials will be included on the Consolidated List of Debarred, Suspended, and Ineligible Contractors (FAR 9.404) in accordance with the procedures established at FAR 9.404.

(b) Agencies shall establish procedures for the use of the consolidated list to ensure that the agency does not solicit offers from, award contracts to, or consent to subcontracts with listed contractors, except as provided in FAR 9.405(a).

[50 FR 41146, Oct. 9, 1985]

Subpart 101-45.7—Submission of Bids

SOURCE: 37 FR 24666, Nov. 18, 1972, unless otherwise noted.

§ 101-45.700 Scope of subpart.

This subpart prescribes policies and methods relating to bids submitted in advertised sales of Government personal property and includes the treatment of late bids received in connection with such sales.

§ 101-45.701 Responsiveness of bids.

(a) To be considered for award, a bid must comply in all material respects with the invitation for bids so that, both as to the method and timeliness of submission and as to the substance of any resulting contract, all bidders may stand on an equal footing and the integrity of the formal advertising system may be maintained.

(b) Telegraphic or telephonic bids shall not be considered unless otherwise provided in the invitation for bids. (See § 101-45.4901-114C, item No. 3 entitled "Consideration of Bids.") The term "telegraphic bids" includes bids submitted by telegram or by mailgram. The following statement should be included in all invitations for bids: "The terms 'telegraphic bid' and 'telegraphic notice' include bids and notices by telegram or by mailgram."

(c) Bids shall be filled out, executed, and submitted in accordance with the instructions contained in the invita-

tion for bids. If a bidder uses his own bid form or a letter to submit a bid, the bid may be considered only if (1) the bidder accepts all the terms and conditions of the invitation for bids and (2) award on the bid would result in a binding contract, the terms and conditions of the invitation.

[37 FR 24666, Nov. 18, 1972, as amended at 43 FR 11820, Mar. 22, 1978]

§ 101-45.702 Time of bid submission.

Bids shall be submitted so as to be received by the contracting officer not later than the exact time set for opening of bids. When telegraphic bids are authorized and such a bid is received by telephone from the receiving telegraph office not later than the time set for opening of bids, it shall be considered only if the bid is confirmed by receipt of a copy of the telegram or mailgram which formed the basis for the telephone call.

[43 FR 11821, Mar. 22, 1978]

§ 101-45.703 Late bids.

§ 101-45.703-1 General.

Bids received by the contracting officer after the exact time set for bid opening are late bids. (See §§ 101-45.4904-1-114C-1, 101-45.4901-114C-2, and 101-45.4901-114C-3 for item entitled "Consideration of late Bids, Modifications, or Withdrawals.") Late bids shall not be considered for award except as authorized in this § 101-45.703.

[42 FR 40854, Aug. 12, 1977]

§ 101-45.703-2 Consideration for award.

(a) A late bid shall be considered for award only:

(1) In the instance of sealed bid sales, if the bid submitted by mail was received by the contracting officer prior to award, was mailed and, in fact, delivered to the address specified in the invitation in sufficient time to have been received by the contracting officer by the time and date set forth in the invitation for opening of bids, and except for delay attributable to personnel of the sales office or their designees would have been received on time; or

§ 101-45.703-3

(2) In the instance of spot bid and auction sales, if the bid submitted by mail (where authorized) was received by the contracting officer after the time and date set forth in the invitation for receipt of bids but before the time set for the start of the sale, and was mailed and, in fact, delivered to the address specified in the invitation in sufficient time to have been received by the contracting officer by the time and date set forth in the invitation for receipt of bids, and except for delay attributable to personnel of the sales office or their designees would have been received on time.

(b) The only evidence acceptable to establish timely receipt of bids at the address designated in the invitation for bids is documentary evidence of receipt at such address within the control of the selling agency. Such evidence could be a date or time stamp, or a log entry.

§ 101-45.703-3 Telegraphic bids.

A late bid submitted by telegraph (where authorized) received before award shall not be considered for award regardless of the cause of the late receipt, including delays caused by the telegraph company, except for a telegraphic bid delayed solely because of mishandling on the part of the Government in its transmittal to the office designated in the invitation for bids for the receipt of bids.

§ 101-45.703-4 Handcarried bids.

A late handcarried bid or any other late bid not submitted by mail, telegram, or mailgram shall not be considered for award.

[43 FR 11821, Mar. 22, 1978]

§ 101-45.703-5 Disposition of late bids.

A late bid which is not for consideration shall be returned to the bidder as promptly as possible (unless other disposition is requested or agreed to by the bidder). However, an unidentified late bid may be opened solely for the purpose of identification and then only by the contracting officer or his authorized representative. Late bids opened for identification purposes or by mistake shall be resealed in the envelope. The contracting officer or his authorized representative shall immediately

41 CFR Ch. 101 (7-1-01 Edition)

write on the envelope his signature and position, date and time opened, invitation for bids number, and an explanation of the opening. No information contained therein shall be disclosed to anyone.

§ 101-45.703-6 Records.

To the extent available, the following information shall be included in the contract case files with respect to each late bid:

- (a) A statement of the date and hour of mailing or filing;
- (b) A statement of the date and hour of receipt;
- (c) A mechanical reproduction of the envelope, or other covering, if the late bid was returned, in lieu of paragraphs (a) and (b) of this section;
- (d) The determination of whether the late bid was considered for award, with supporting facts;
- (e) A statement of the disposition of the late bid; and
- (f) The envelope, or other covering, if the late bid was considered for award.

§ 101-45.704 Modification or withdrawal of bids.

(a) Bids may be modified or withdrawn by written or telegraphic notice received by the contracting officer not later than the exact time set for opening of bids (in the instance of sealed bid sales) or not later than the exact time set for the receipt of mailed-in or telegraphic bids (in the instance of spot bid and auction sales where such bids are authorized). A telegraphic modification or withdrawal of a bid received by telephone from the receiving telegraph office not later than the time set for opening of bids shall be considered only if the message is confirmed by receipt of a copy of the written telegram or mailgram which formed the basis for the telephone call. Modifications received by telegram or mailgram (including a record of those telephoned by the telegraph company) shall be sealed in an envelope by a proper official who shall write thereon the date and time of receipt and by whom received, the invitation for bids, number, and his signature. No information contained therein shall be disclosed before the time set for bid opening or for the start of the sale. The term *telegraphic notice*

Federal Property Management Regulations

§ 101-45.803

includes modifications and withdrawals submitted by telegram or mailgram. The following statement should be included in all invitations for bids:

The terms *telegraphic bid* and *telegraphic notice* include bids and notices by telegram or by mailgram.

(b) A bid may be withdrawn in person by a bidder or his authorized representative, provided his identity is made known and he signs a receipt for the bid, but only if the withdrawal is prior to the exact time set for the opening of bids (in the instance of sealed bid sales) or the exact time set for the start of the sale (in the instance of spot bid and auction sales).

[37 FR 24666, Nov. 18, 1972, as amended at 43 FR 11821, Mar. 22, 1978]

§ 101-45.705 Late modifications and withdrawals.

(a) Modifications of bids and requests for withdrawal of bids which are received by the contracting officer after the exact time set for bid opening (in sealed bid sales) or after the exact time set for the receipt of bids (in spot bid or auction sales) are "late modifications" and "late withdrawals", respectively. A late modification or late withdrawal shall be subject to the provisions of § 101-45.703. However, a late modification of the otherwise successful bid shall be opened at any time it is received; and if in the judgment of the contracting officer it makes the terms of the bid more favorable to the Government, it shall be considered.

(b) Mailed-in, telegraphic, and mailgram modifications or withdrawals which are received by the contracting officer after the time set for the start of a spot bid or auction sale shall not be considered, regardless of the cause of delay.

[37 FR 24666, Nov. 18, 1972, as amended at 43 FR 11821, Mar. 22, 1978]

Subpart 101-45.8—Mistakes in Bids

SOURCE: 32 FR 16270, Nov. 29, 1967, unless otherwise noted.

§ 101-45.800 Scope of subpart.

This subpart prescribes the policies and methods governing the treatment by executive agencies of mistakes in bids by bidders in sales of personal property. The authorities prescribed herein are not intended to nullify previous authorities granted by the Comptroller General.

§ 101-45.801 General.

After the opening of bids, sales contracting officers shall examine all bids for mistakes. Where the sales contracting officer has reason to believe that a mistake may have been made, he shall request from the bidder a verification of the bid, calling attention to the suspected mistake. If the bidder alleges a mistake, the matter shall be processed in accordance with this subpart 101-45.8. Such actions shall be taken prior to award.

§ 101-45.802 Apparent clerical mistakes.

Any clerical mistake apparent on the face of a bid may be corrected by the sales contracting officer prior to award if the sales contracting officer has first obtained from the bidder verification of the bid actually intended. An example of such an apparent mistake is an error in placing the decimal point (e.g., a bidder bids \$10 each on 10 units, but shows an extended price of \$1,000 or a bidder bids \$0.50 per lb. for 1,000 lbs. but shows an extended price of \$50). Any correction made pursuant to this § 101-45.802 shall be reflected in the award document, if an award is made on the corrected bid.

§ 101-45.803 Other mistakes disclosed before award.

(a) Heads of executive agencies are authorized (with power of redelegation as provided in §§ 101-45.803(b) and 101-45.804(d)), in order to minimize delay in contract awards, to make the administrative determinations described in this § 101-45.803 in connection with mistakes in bids alleged after opening of bids and before award. The authority contained herein to permit correction of bids is limited to bids which, as submitted, are responsive to the invitation for bids, and may not be used to permit

§ 101-45.803

41 CFR Ch. 101 (7-1-01 Edition)

correction of bids to make them responsive. This authority is in addition to that in §101-45.802 or that which may be otherwise available.

(1) A determination may be made permitting the bidder to withdraw his bid where the bidder requests permission to do so and clear and convincing evidence establishes the existence of a mistake.

(2) However, if the evidence is clear and convincing both as to the existence of a mistake and as to the bid actually intended, and if the bid as submitted and as corrected is the highest received, a determination may be made to correct the bid and not permit its withdrawal.

(3) A determination may be made permitting the bidder to correct his bid where the bidder requests permission to do so and clear and convincing evidence establishes both the existence of a mistake and the bid actually intended. However, if the correction would result in displacing one or more higher acceptable bids, the determination shall not be made unless the existence of the mistake and the bid actually intended are ascertainable substantially from the invitation and bid itself. If the evidence is clear and convincing only as to the mistake, but not as to the intended bid, a determination permitting the bidder to withdraw his bid may be made.

(4) If the evidence does not warrant a determination under paragraph (a)(1), (2), or (3) of this section, a determination may be made that a bidder may neither withdraw nor correct his bid.

(b) Heads of executive agencies may delegate to one central authority in their agencies, without power of redelegation, authority to make the determinations under paragraphs (a) (2), (3), and (4) of this §101-45.803. The authority to make determinations to permit withdrawal of bids as provided in paragraphs (a) (1) and (3) of this section may be delegated, without power of redelegation, to any sales activity having legal counsel available.

(c) Each proposed determination shall be approved by the agency's General Counsel, Deputy or Associate General Counsel, and Assistant General Counsel, or other comparable legal officer. However, authority to approve de-

terminations to permit withdrawal of bids pursuant to paragraphs (a) (1) and (3) of this section may be delegated to the legal counsel of sales activities.

(d) Suspected or alleged mistakes shall be processed as follows:

(1) Whenever the sales contracting officer suspects that a mistake may have been made in a bid, he shall immediately request the bidder to verify the bid. Such request shall inform the bidder of the basis for suspecting a mistake and shall advise the bidder that if a mistake is alleged, to support his allegation by statements concerning the alleged mistake and by all pertinent evidence; such as the bidder's file copy of the bid, his original worksheets and other data used in preparing the bid, and any other evidence which conclusively establishes the existence of the error, the manner in which it occurred, and the bid actually intended. If the time for acceptance of bids is likely to expire before a decision can be made, the sales contracting officer shall request all bidders whose bids may become eligible for award to extend the time for acceptance of their bids. If the bidder whose bid is believed erroneous does not grant such extension of time and a decision cannot be reached before expiration of the time for acceptance, even if handled by telegraph or telephone as provided in §101-45.803(d)(4), the bid shall be considered as originally submitted.

(2) If the bidder verifies his bid, the sales contracting officer shall consider it as originally submitted.

(3) Where the bidder furnishes evidence in support of an alleged mistake, the case shall be referred to the appropriate authority together with the following data:

(i) All evidence furnished by the bidder.

(ii) A copy of the bid and the invitation for bids.

(iii) An abstract or record of the bids received.

(iv) A written statement by the sales contracting officer setting forth—

(a) The expiration date of the bid in question and of the other bids submitted;

(b) Specific information as to how and when the mistake was alleged;

Federal Property Management Regulations

§ 101-45.804

(c) Most recent contract price for a like item(s) involved, when sold, in what quantity, relative condition, etc.;

(d) A summary of the evidence submitted by the bidder;

(e) Any additional evidence considered pertinent, including copies of all correspondence between the sales contracting officer and the bidder concerning the alleged mistake; and

(f) The course of action with respect to the bid that the sales contracting officer considers proper on the basis of the evidence.

(4) When time is of the essence, because of the expiration of bids or otherwise, the sales contracting officer may refer the case by telegraph or telephone to the designated authority. Ordinarily, however, sales contracting officers will not refer mistake in bid cases to the designated authority by telegraph or telephone, particularly when the determinations set forth in paragraphs (a)(2) and (3) of this §101-45.803 are applicable, since actual examination of the evidence is generally necessary to determine the proper action to be taken.

(5) Where the bidder fails or refuses to furnish evidence in support of a suspected or alleged mistake, the sales contracting officer shall consider the bid as submitted unless there are indications of error so clear as reasonably to justify the conclusion that acceptance of the bid would be unfair to the bidder or to other bona fide bidders, in which case it may be rejected. This action will be cleared through counsel serving the cognizant sales contracting officer. The attempts made to obtain the information required and the action taken with respect to the bid shall be fully documented.

(e) Nothing contained in this §101-45.803 shall deprive the Comptroller General of his statutory right to question the correctness of any administrative determination made hereunder nor deprive any bidder of his right to have the matter determined by the Comptroller General should he so request. All doubtful cases shall be submitted to the Comptroller General for advance decision in accordance with agency procedures.

(f) Each agency shall maintain records of all administrative deter-

minations made in accordance with this §101-45.803, the facts involved, and the action taken in each case. Copies of all such administrative determinations shall be included in the case file. Where a contract is awarded, the General Accounting Office copy of the contract, whenever filed, shall be accompanied by a signed copy of any related determination.

[32 FR 16270, Nov. 29, 1967, as amended at 42 FR 31455, June 21, 1977; 42 FR 34881, July 7, 1977]

§ 101-45.804 Mistakes disclosed after award.

(a) When a mistake in bid is not discovered until after the award, the mistake may be corrected by supplemental agreement if correcting the mistake would make the contract more favorable to the Government without changing the essential requirements of the contract.

(b) In addition to the cases contemplated in §101-45.804(a), heads of executive agencies are authorized, under the circumstances set forth in §101-45.804(c), to make the administrative determinations described below in connection with mistakes in bids alleged or disclosed after award. This authority is in addition to that provided by Public Law 85-804 (50 U.S.C. 1431-1435) or that which may be otherwise available.

(1) A contract may be rescinded in its entirety where the original total contract amount does not exceed \$10,000.

(2) A contract, irrespective of amount, may be reformed (i) by deleting the item or items involved in the mistake where the deletion does not reduce the contract amount by more than \$10,000; or (ii) by decreasing the price where the resultant decrease in price does not exceed \$10,000 and the reformed contract price is not less than that of the otherwise next high bid under the original invitation for bids.

(c) Determinations under §101-45.804(b) may be made only on the basis of clear and convincing evidence that a mistake in bid was made, and either that the mistake was mutual or that the unilateral mistake made by the purchaser was so apparent as to have charged the sales contracting officer with notice of the probability of the

§ 101-45.805

41 CFR Ch. 101 (7-1-01 Edition)

mistake. If the evidence does not warrant a determination under paragraph (b)(1) or (2) of this §101-45.804, determination may be made that no change shall be made in the contract as awarded.

(d) Heads of executive agencies may delegate to one central authority in their agencies, without power of redelegation, authority to make the determinations under this §101-45.804.

(e) Each proposed determination shall be approved by the agency's General Counsel, Deputy or Associate General Counsel, an Assistant General Counsel, or other comparable legal officer.

(f) Mistakes disclosed after award shall be processed as follows:

(1) Whenever a mistake in bid is alleged or disclosed after award, the sales contracting officer shall advise the purchaser to support the alleged error by written statements and by all pertinent evidence, such as the purchaser's file copy of the bid, his original worksheets and other data used in preparing the bid, and any other evidence which will serve to establish the mistake, the manner in which it occurred, and the bid actually intended.

(2) Where the purchaser furnishes evidence in support of an alleged mistake, the case shall be referred to the appropriate authority together with the following data:

(i) All evidence furnished by the purchaser.

(ii) A copy of the contract, including a copy of the bid.

(iii) An abstract or record of the bids received.

(iv) A written statement by the sales contracting officer setting forth—

(a) Specific information as to how and when the mistake was alleged or disclosed;

(b) A summary of the evidence submitted by the purchaser;

(c) His opinion whether a bona fide mistake was made in the bid and whether he was, or should have been, on constructive notice of the mistake before the award, together with the reasons or data upon which his opinion is based;

(d) Most recent contract price for a like item(s) involved, when sold, in what quantity, relative condition, etc.;

(e) Any additional evidence considered pertinent, including copies of all relevant correspondence between the sales contracting officer and the purchaser concerning the alleged mistake;

(f) The course of action with respect to the alleged mistake that the sales contracting officer considers proper on the basis of the evidence; and

(g) The status of performance and payments under the contract, including contemplated performance and payments.

(g) Nothing contained in this §101-45.804 shall deprive the Comptroller General of his statutory right to question the correctness of any administrative determination made hereunder nor deprive any purchaser of his right to have the matter determined by the Comptroller General should he so request.

(h) Each agency shall maintain records of all administrative determinations made in accordance with this §101-45.804, the facts involved, and the action taken in each case. A copy of the determination shall be attached to each copy of any contract rescission or reformation resulting therefrom.

(i) Where administrative determination is precluded by the limitations set forth in this section, the matter will be submitted to the Comptroller General for decision in accordance with agency procedures.

(j) Nothing contained in this §101-45.804 prevents an agency from submitting doubtful cases to the Comptroller General.

[32 FR 16270, Nov. 29, 1967, as amended at 40 FR 59439, Dec. 24, 1975]

§ 101-45.805 Mistakes disclosed after award in negotiated sales.

When a mistake in a purchaser's quotation is not discovered until after award, the authority to correct mistakes contained in this subpart 101-45.8 may be utilized in accordance with the limitations and procedures set forth herein.

[35 FR 12121, July 29, 1970]

Federal Property Management Regulations

§ 101-45.1002-4

Subpart 101-45.9—Abandonment or Destruction of Personal Property

SOURCE: 65 FR 63549, Oct. 24, 2000, unless otherwise noted.

§ 101-45.900 Cross-reference to the Federal Management Regulation (FMR) (41 CFR chapter 102, parts 102-1 through 102-220).

For information on the abandonment or destruction of personal property previously contained in this subpart, see 41 CFR part 102-36 (§§ 102-36.305 through 102-36.330).

Subpart 101-45.10—Recovery of Precious Metals

SOURCE: 53 FR 16123, May 5, 1988, unless otherwise noted.

§ 101-45.1000 Scope of subpart.

This subpart prescribes the policy and procedures for recovery of precious metals from articles of excess and surplus personal property.

§ 101-45.1001 General.

GSA is responsible for the initiation and development of Government-wide precious metals recovery programs, and for the issuance and administration of applicable contracts, except those issued and administered by DOD for precious metals recovery and refinement operations. Situations will occur where, in terms of economy, efficiency, and environmental quality, it is in the best interest of the Government to recover precious metals from articles of excess and surplus personal property instead of using other methods of disposal. GSA will determine when Government-wide recovery is appropriate on the basis of an evaluation of the supply-demand factor, the price of the commodity, the cost of recovering the precious metal, and applicable guidelines or regulations on pollution control.

§ 101-45.1002 Agency responsibilities.

Heads of executive agencies are responsible for establishing, maintaining, and pursuing a program for recovery of precious metals. The provisions of this § 101-45.1002 provide guidance

with respect to surveys, assignments of program monitors, and internal audits. Precious metals that may be designated for recovery include gold, silver, and metals in the platinum family. Examples of silver bearing scrap and waste include used photographic fixing (hypo) solution, photographic and X-ray film, silver alloys, and dental scrap. Other examples of precious metals bearing materials include electronic scrap, ADPE, welding and brazing wire, anodes, and batteries. Certain strategic and critical materials may also be designated for recovery.

[62 FR 34013, June 24, 1997]

§ 101-45.1002-1 Precious metals recovery surveys.

Each agency shall identify those activities that generate silver or other precious metals (including used hypo solution, scrap film, and other precious metals bearing materials). Activities identified as generating precious metals bearing materials shall be surveyed to obtain information regarding actual or potential precious metals recovery. Estimates of potential recovery may be obtained through use of testing papers for hypo solution; various charts, tables, and scales for scrap film, assays of samples of precious metals bearing materials; or other acceptable methods of estimating potential precious metals contents.

§ 101-45.1002-2 [Reserved]

§ 101-45.1002-3 Precious metals recovery program monitor.

Each agency should designate an individual to monitor its precious metals recovery program. Responsibilities of the precious metals monitor should include conducting and initiating surveys; implementing and improving recovery procedures; and monitoring the agency's recovery program.

[62 FR 34013, June 24, 1997]

§ 101-45.1002-4 Internal audits.

Each agency should require periodic internal audits of its precious metals recovery program. The internal audits should be of such frequency and scope as to provide for proper control over the recovery, storage, and disposition

§ 101-45.1003

of precious metals bearing materials. Primary elements for review should include document control and record maintenance; storage facilities and security controls; methods of recovery and equipment operation; and procedures for recovering precious metals through service contracts or disposal through sales contracts.

§ 101-45.1003 Recovery of silver from precious metals bearing materials.

(a) Each agency should recover silver regardless of the quantity of used hypo solution or scrap film generated. Installations of a silver recovery unit consistent with the quantity of used hypo solution generated or storage of used hypo solution or scrap film until a processible quantity is obtained are two alternatives. If an activity generates small quantities of hypo solution and tests show that there is a minimal amount of silver per gallon of solution, arrangements should be made, to the extent feasible, with another activity in the area which is using a recovery unit to receive and process the hypo solution. When the actual amount of silver recovered is substantially less than the estimated amount potentially recoverable, agencies should fully document the reason for the substantial difference.

(b) When recovery by an agency is not economically feasible and consolidation with other activities is not practical, the regional GSA Federal Supply Service Bureau serving the area or the Defense Logistics Agency (DLA) (in accordance with § 101-45.1004) should be contacted for assistance. If it is determined that silver recovery cannot be accomplished economically by Government-owned equipment or by a commercial recovery contractor, the hypo solution, scrap film, or other silver bearing materials should be disposed of in accordance with part 101-45 in an environmentally acceptable manner.

§ 101-45.1003-1 Guidelines for the recovery of silver from used hypo solution and scrap film.

The basic factors that determine the potential quantity of recoverable silver are: The amount of used hypo solution or scrap film generated; the amount and type of film processed; and the

41 CFR Ch. 101 (7-1-01 Edition)

physical layout and available recovery equipment of the photographic facility. Since these factors may vary for each facility, a single method of recovery cannot be prescribed.

§ 101-45.1003-2 Recovery of silver from used hypo solution.

Used hypo solution should be processed to recover the maximum amount of silver from the solution, consistent with overall economic feasibility and environmental considerations. Recovery can be effected either by Government-owned equipment or through use of commercial recovery contracts. Various types and sizes of equipment using metallic replacement or electrolytic methods of recovery are available which permit economic silver recovery from both large and small quantities of used hypo solution.

§ 101-45.1003-3 Recovery of silver from scrap film.

Scrap film, the silver content of which varies according to the type of film and the degree of exposure, is a major source of recovered silver. One method of recovering silver from scrap film is by burning the film in specially designed and approved incinerators. The burning reduces the film to high content silver bearing ash which can be economically processed to produce fine silver. Recovery onsite by controlled burning should only be accomplished at those activities or installations where approved facilities exist and the local code on burning permits it. A common alternative method of recovery is through periodic disposal of accumulated scrap film by sale in accordance with part 101-45.

§ 101-45.1004 Recovery and use of precious metals through the DOD Precious Metals Recovery Program.

Civil agencies may use the DOD Precious Metals Recovery Program as prescribed in § 101-45.1004.

§ 101-45.1004-1 Civil agency participation in the DOD Precious Metals Recovery Program.

(a) Civil agencies wishing to participate in the DOD precious metals recovery system should contact the Manager, DOD Precious Metals Recovery

Federal Property Management Regulations

§ 101-45.4800

Program, Attention: DLA-MMLC, Fort Belvoir, VA 22060, for further information regarding the following plans:

(1) *Plan I.* An appraisal or survey of the agency's precious metals recovery potential and a recommendation as to appropriate recovery techniques and equipment;

(2) *Plan II.* DLA acceptance of photographic wastes, excess, and other precious metals bearing materials at Defense Reutilization and Marketing Offices (DRMO's) or other disposition sites;

(3) *Plan III.* Disposition and shipping instructions for recovered precious metals bearing materials not authorized for acceptance at local DRMO's;

(4) *Plan IV.* Assistance and recommendations as needed in the administration and operation of the agency's precious metals recovery program including an appraisal or survey of recovery potential; the furnishing of recovery and other supporting equipment; and the prescribing of procedures for the security and disposition of precious metals bearing materials. This plan will, in most cases, require a formal Memorandum of Understanding between DLA and the participating agency.

(b) Services addressed in the above plans will be provided to the extent that DLA resources permit.

(c) DLA will provide recovered fine precious metals to participating agencies (those generating precious metals bearing scrap for the DOD Precious Metals Recovery Program) for use as Government Furnished Materials (GFM) or other authorized internal uses in accordance with §101-45.1004-2.

[53 FR 16123, May 5, 1988, as amended at 62 FR 34013, June 24, 1997]

§ 101-45.1004-2 Use of DOD-recovered fine precious metals.

To determine the need for recovered fine precious metals as GFM to reduce new procurement costs, each agency shall review procurements for which fine precious metals will be required by a contractor. Each agency having requirements for recovered fine precious metals as GFM or for other authorized internal uses should submit a request to the Commander, Defense Industrial Supply Center (DISC), Attention:

DISC-OIBA/YC, 700 Robbins Avenue, Philadelphia, Pennsylvania 19111-5096. Recovered fine precious metals will be provided to agencies for use as GFM or for other authorized internal uses on a "as-needed-when-available" basis. There is a nominal charge for the recovered fine precious metals. Normally, the amount of recovered fine precious metals authorized for issue to individual civil agencies will not be restricted, except in those instances when the precious metals involved are not available in sufficient quantities to satisfy all requirements. No minimum ordering quantity is prescribed. Requiring activities should contact DISC to assure asset availability prior to the requisitioning of any quantity of precious metal other than silver. Advance inquiries for silver should be made only when requirements exceed 5,000 troy ounces.

Subparts 101-45.11—101-45.46 [Reserved]

Subpart 101-45.47—Reports

§ 101-45.4700 Scope of subpart.

This subpart prescribes the requirements for reporting to GSA on matters pertaining to the general subject area of disposal of personal property.

[42 FR 56027, Oct. 20, 1977]

§ 101-45.4701 [Reserved]

§ 101-45.4702 Negotiated sales reports.

An annual report listing and describing any negotiated disposals of surplus personal property having an estimated fair market value of more than \$5,000, other than disposals for which an explanatory statement has been transmitted (see §101-45.304-2(c)), shall be submitted by each Federal agency to GSA within 60 calendar days after the close of each fiscal year.

[54 FR 38676, Sept. 20, 1989]

Subpart 101-45.48—Exhibits

§ 101-45.4800 Scope of subpart.

This subpart 101-45.48 exhibits information referenced in the text of part

§ 101-45.4801

101-45 that is not suitable for inclusion elsewhere in that part.

[42 FR 40855, Aug. 12, 1977]

§ 101-45.4801 Instructions for the preparation of advance notice to the Department of Commerce.

1. *Transmittal of notice.* Section 101-45.304-7 provides that when the acquisition cost of personal property to be sold at one time at one place is \$250,000 or more, the disposal agency shall cause a notice of each such proposed sale to be transmitted to the U.S. Department of Commerce, room 1300, 433 West Van Buren Street, Chicago, Ill. 60607.

The notice shall be sent at as early a date as possible in advance of the sale but at least 20 days prior to the date when the bids will be opened, or, in the case of spot bid or auction sale, when the sale will be conducted. Such notice shall be transmitted by fastest mail available and shall be in synopsis form suitable for printing direct from the text so transmitted without editing or condensing.

These notices are for use of the Department of Commerce in making regular publication of a synopsis of principal proposed sales of Government personal property.

2. *Format and content of notice.*

a. *Information to be furnished.* The following information shall be provided in the order listed so as to preserve the format of the Department of Commerce publication: the name of the office which will issue the invitation; the name or title, address, and telephone number of the official from whom copies of the sales offering and other information can be obtained; a description of the property to be sold; when deemed desirable; the total estimated acquisition cost; the number of the invitation or sale; the date of the sale or bid opening, the types of sale, i.e., sealed bid, spot bid, or auction; and the location(s) of the property.

b. *Detailed requirements.* In preparing the notice to the Department of Commerce, the utmost care should be exercised in describing the types of property to be sold in order to assure interest by the maximum number of potential buyers but, at the same time, condense the information so that minimum space in the Department of Commerce publication will be required for printing. While the various kinds of property to be sold should be stated concisely, the names of important items should not be omitted. The following example is provided as a guide, both as to the order in which the information should be given, the extent to which information should be condensed or expanded, depending upon the size of the sale, and the format which, if followed, will facilitate publication without editing. Attention is specially invited to the double spacing the "hanging" indention, and the length of the

41 CFR Ch. 101 (7-1-01 Edition)

line which should be approximately 65, but not to exceed 69, character spaces.

EXAMPLE

General Services Administration, Region 8, Business Service Center, Building 41, Denver Federal Center, Denver, Colo.

Scrapers, Graders, Street Sweeper, Crawler Tractor, Air Compressors, Power Units, Cement Mixer—Total acquisition cost \$269,850. Invitation No. 8 UPS-65-41—Bid opening 11-30-65. Sealed bid, location above.

Motor vehicles, passenger cars and 3/4-ton to 5-ton trucks, materials handling equipment, fork lift trucks and warehouse tractors, jack lift trucks, warehouse trailers, platform and box trucks, hand tools, hardware, plumbing equipment, special industry machinery, office machines, furniture, rope, cable chair and fittings, miscellaneous gasoline and water hose; burlap bags, barrier paper, pack saddles, tape and webbing, lanterns, spare parts for compressors, tractors, shovels, bulldozers, cranes, welding equipment, motor vehicles, air hammer diesel and gasoline engines—Total estimated acquisition cost \$6 million; Sale No. 8UPS-A-65-44. Sale starts 12-15-65. Auction sale, location above.

[30 FR 2930, Mar. 6, 1965; 30 FR 3384, Mar. 13, 1965. Redesignated at 42 FR 40855, Aug. 12, 1977]

§ 101-45.4802 Sample format—irrevocable letter of credit.

(Name and address of bank issuing letter of credit)
(Date)
(Number of letter of credit and reference)
Treasurer of the United States
Washington, DC 20220

Dear Madam: We hereby establish our irrevocable letter of credit No. _____ in your favor by order and for account of (name of company submitting bid) up to an aggregate amount of \$ _____ available by demand drafts drawn on us by a representative of (specify agencies to which directed: e.g., Department of the Army, Department of the Air Force, General Services Administration). Drafts must be accompanied by a written statement of the interested agency that the amount drawn under this credit represents (1) the deposit required as a guarantee to support an acceptable bid made by (name of bidder) to purchase material from the Government, or (2) payment in full for the property. Drafts drawn under this credit must be marked "drawn under letter of credit No. _____ of (name and address of issuing bank)."

Unless otherwise expressly stated herein, this credit is subject to the Uniform Customs and Practice for Commercial Documentary Credits© fixed by the 13th Congress of the

Federal Property Management Regulations

§ 101-45.4806

International Chamber of Commerce. We hereby agree with you that the drafts drawn under and in compliance with the terms of this credit shall be duly honored on due presentation to the (name of the bank) if presented on or before _____.

Very truly yours, (Authorized signature of bank official).

[59 FR 26739, May 24, 1994]

§ 101-45.4803 General instructions for preparation of irrevocable letter of credit.

Use either clause (1) or (2) of § 101-45.4802, as applicable.

Some banks use language which varies from that shown in § 101.45.4802. Variations from the prescribed text maybe permitted if the meaning of the letter of credit prepared by the bank is the same. Each of the paragraphs of the prescribed letter of credit is an essential part of the agreement. No paragraphs shall be added and none shall be deleted.

A letter of credit may be addressed to a specific department or agency instead of "Treasurer of the United States," letters of credit of this type shall be addressed to the head of the agency or department, as the Secretary of the Army, or the Administrator of General Services. Should this be done, the words "Treasurer of the United States for the account of" shall be deleted from the draft drawn under the letter of credit.

Each letter of credit must be clearly irrevocable and is not acceptable if the expiration date stated therein is less than 30 days from the date of the sale at which it is used.

[59 FR 26739, May 24, 1994]

§ 101-45.4804 Sample format—draft drawn against irrevocable letter of credit.

FORM OF DRAFT

\$ _____ Date _____

At sight pay to the order of Treasurer of the United States for the account of (specify name of department or agency). _____ dollars and _____ cents for value received—drawn under letter of credit No. _____ of _____

(Name and address of issuing bank)

To _____

(Name and address of bank)

(Name of office—finance or disbursing—and activity of department or agency by which draft is issued.)

By _____

Title _____

Date _____

NOTE: If the letter of credit is addressed to a department or agency rather than the Treasurer, omit the words "Treasurer of the

United States for the account of," and in lieu thereof insert the name of the particular department or agency or installation or office thereof.

[30 FR 2930, Mar. 6, 1965. Redesignated at 42 FR 40855, Aug. 12, 1977]

§ 101-45.4805 Sample format—transmittal letter to accompany letter of credit.

OFFICIAL LETTERHEAD

To: Name of bank (same as on L/C).

Gentlemen:

This is to certify that on ____, 196__, at a sale held by the (insert the name of the department or agency) at (insert location) the (insert name and address of company) submitted acceptable bids for property at sales price of \$ ____.

The amount of the accompanying draft, \$ _____, drawn under letter of credit No. _____ represents (1) the deposit of ____ percent of the sales price required as a guarantee to support the acceptable bid made by (insert name of company) to purchase material from the Government, or (2) payment in full for the property on which (insert name of company) submitted acceptable bids.

(Name of office—finance or disbursing—and activity of department or agency to which check is to be forwarded.)

By _____

Title _____

Date _____

NOTE: Strike out the clause in the second paragraph which is not applicable.

[30 FR 2930, Mar. 6, 1965. Redesignated at 42 FR 40855, Aug. 12, 1977]

§ 101-45.4806 Outline for preparation of explanatory statement relative to negotiated sales.

The following outline shall be used for the preparation of explanatory statements relative to negotiated sales:

EXPLANATION STATEMENT OF PROPOSED NEGOTIATED DISPOSAL OF SURPLUS PERSONAL PROPERTY SUBMITTED PURSUANT TO THE PROVISIONS OF SECTION 203(e)(6) OF THE FEDERAL PROPERTY AND ADMINISTRATIVE SERVICES ACT OF 1949, 63 STAT. 386, AS AMENDED (40 U.S.C. 484(c)(6))

Description of property (including quantity and condition).

Use of property (an indication of the use of the property made by the Government).

Location.

Reported excess by (name of agency and date).

Excess and donation screening (show the extent of screening and results).

§ 101-45.4807

Acquisition cost and date (if not known, estimate and so indicate).

Income (all income known to the holding agency, if any received by the Government for use of the property).

Estimated fair market value (including date of estimate and name of estimator).

Proposed disposal price.

Proposed purchaser (name and address).

Intended use (state the intended use of the property by the proposed purchaser).

Justification (a narrative statement containing complete justification for the proposed sale and other pertinent facts involved in the Government's decision to sell by negotiation).

[31 FR 5001, Mar. 26, 1966. Redesignated at 42 FR 40855, Aug. 12, 1977]

§ 101-45.4807 [Reserved]

§ 101-45.4808 State health agencies.

State Health Agencies (for Bedding and Upholstered Furniture Information).

ALABAMA

Director, Division of Environmental Health, State Office Building, Montgomery, AL 36104.

ALASKA

Chief, Environmental Health Section, Division of Public Health, Department of Health and Social Services, Pouch H 01, Juneau, AK 99811.

ARIZONA

Arizona Department of Health Services, Bureau of Sanitation, Bedding Section, 411 North 24th Street, Phoenix, AZ 85008.

ARKANSAS

Bureau of Public Health Engineering, Arkansas Department of Health, 13th Floor, Donaghey Building, 7th and Main Streets, Little Rock, AR 72201.

CALIFORNIA

Chief, Bureau of Home Furnishings, State of California, Department of Home Furnishings, 3401 La Grande Boulevard, Sacramento, CA 95823.

COLORADO

Chief, Consumer Protection Section, State of Colorado, Department of Health, 4210 East 11th Avenue, Denver, CO 80220.

CONNECTICUT

Commissioner, Department of Consumer Protection, Division of Bedding and Upholstered Furniture, 165 Capitol Avenue, Hartford, CT 06115.

41 CFR Ch. 101 (7-1-01 Edition)

DELAWARE

Chief, Bureau of Environmental Health, Department of Health and Social Services, Division of Public Health, Post Office Box 637, Dover, DE 19901.

DISTRICT OF COLUMBIA

Environmental Health Scientist, Administrator, Room 733, Environmental Health Administration, 801 North Capitol Street, NE., Washington, DC 20001.

FLORIDA

Chief, Department of Health and Rehabilitative Services, Consumer Drugs and Devices Control Section, Post Office Box 210, Jacksonville, FL 32201.

GEORGIA

Director, Consumer Protection Field Forces, Georgia Department of Agriculture, 19 Martin Luther King Drive, Room 308, Atlanta, GA 30334.

HAWAII

Chief, Sanitation Branch, State Department of Health, Honolulu, HI 96813.

IDAHO

Chief, Idaho Department of Health and Welfare, Division of Environment, Milk and Food Section, Statehouse, Boise, ID 83720.

ILLINOIS

No need to notify.

INDIANA

Supervisor, Sanitary Bedding Section, Division of Weights and Measures, Indiana State Board of Health, 1330 West Michigan Street, Indianapolis, IN 46206.

IOWA

Secretary, Iowa State Department of Agriculture, State Capitol Building, Des Moines, IA 50319.

KANSAS

Chief, Food and Drug Division, Kansas State Department of Health and Environment, State Office Building, Topeka, KS 66620.

KENTUCKY

Commissioner, Environmental Sanitation Branch, Division of Consumer Health Protection, Health Services Building, 275 East Main Street, Frankfort, KY 40601.

LOUISIANA

Director, Bedding and Upholstered Furniture Division, Louisiana Health and Human Resources Administration, Post Office Box 60630, New Orleans, LA 70160.

Federal Property Management Regulations

§ 101-45.4808

MAINE

Director, Department of Manpower Affairs, Maine Bureau of Labor, State Office Building, Augusta, ME 04333.

MARYLAND

No need to notify.

MASSACHUSETTS

Director, Division of Food and Drugs, Massachusetts Department of Public Health, Statehouse, Boston, MA 02133.

MICHIGAN

Chief, Michigan Department of Public Health, Division of Community Environment Health, Consultation, Evaluation & Training Section, 3500 North Logan Street, Post Office Box 30035, Lansing, MI 48909.

MINNESOTA

Chief, Section of Hotels, Resorts & Restaurants, Minnesota Department of Health, 77 South East Delaware Street, Minneapolis, MN 55440.

MISSISSIPPI

Director, Division of Sanitary Engineering, Mississippi State Board of Health, Post Office Box 1700, Jackson, MS 39205.

MISSOURI

Director, Bureau of Community Sanitation, Department of Social Services, Missouri Division of Health, Broadway State Office Building, Post Office Box 570, Jefferson City, MO 65101.

MONTANA

Director, Food and Consumer Safety Bureau, Environmental Sciences Division, Montana Department of Health and Environmental Science, Helena, MT 59601.

NEBRASKA

Chief, Division of Housing and Environmental Health, 301 Centennial Mall South, Post Office Box 95007, Lincoln, NE 68509.

NEVADA

Chief, Consumer Health Protection Services, Room 103, Kinkead Building, Capitol Complex, Carson City, NV 89710.

NEW HAMPSHIRE

No need to notify.

NEW JERSEY

Director, Division of Environmental Health, New Jersey State Department of Health and Social Services, John Fitch Plaza, Post Office Box 1540, Trenton, NJ 08625.

NEW MEXICO

Director, EIA Legal Section, State of New Mexico, Health and Social Services Department, Post Office Box 2348, Santa Fe, NM 87503.

NEW YORK

Director, Division of Licensing Services, Department of State, 270 Broadway, New York, NY 10007.

NORTH CAROLINA

Head, Solid Waste and Vector Control Branch, Sanitary Engineering Section, Post Office Box 2091, Raleigh, NC 27602.

NORTH DAKOTA

Chief, North Dakota State Department of Health, Division of Environmental Engineering Bedding Program, 1200 Missouri Avenue, Bismarck, ND 58505.

OHIO

Chief, Department of Industrial Relations, Division of Bedding and Upholstered Furniture Inspection, Post Office Box 825, Columbus, OH 43216.

OKLAHOMA

Head, Consumer Information and Product Safety Division, Consumer Protection Service, Oklahoma State Department of Health, Post Office Box 53551, Oklahoma City, OK 73105.

OREGON

Program Supervisor, Department of Human Resources, Health Division, Post Office Box 231, Portland, OR 97207.

PENNSYLVANIA

Chief, Division of Bedding and Upholstery, Department of Labor and Industry, Seventh and Forster Streets, Harrisburg, PA 17120.

PUERTO RICO

Director, Program of Environmental Health, Puerto Rico Department of Health, Ponce de Leon Avenue 1306, Box 9342, Santurce, PR 00908.

RHODE ISLAND

Chief, Division of Upholstery, State of Rhode Island Department of Business Regulation, 49 Westminster Street, Room 420, Providence, RI 02903.

SOUTH CAROLINA

Consultant, Bureau of Environmental Sanitation, South Carolina Department of Health and Environmental Control, 2600 Bull Street, Columbia, SC 29201.

§ 101-45.4900

SOUTH DAKOTA

Director, Division of Sanitary Engineering,
South Dakota Department of Health, Joe
Foss Building, Pierre, SD 57501.

TENNESSEE

Director, Food and Drug Division, Tennessee
Department of Agriculture, Post Office
Box 40627, Melrose Station, Nashville, TN
37204.

TEXAS

Director, Bedding-Law Division, Texas De-
partment of Health Resources, Austin, TX
78756.

UTAH

State Chemists Office, Utah Department of
Agriculture, Laboratory Building, State
Capitol, Salt Lake City, UT 84114.

VERMONT

No need to notify.

VIRGINIA

Supervisor, Bedding and Upholstered Fur-
niture, Department of Health, 109 Governor
Street, Richmond, VA 23219.

VIRGIN ISLANDS

Director, Division of Environmental Health,
Virgin Islands Department of Health, Post
Office Box 1442, Charlotte Amalie, VI 00801.

WASHINGTON

Supervisor, Department of Social and Health
Services, Food and Housing Section, Attn:
Furniture and Bedding Program
(Mailstop)-MS-LD-11, Olympia, WA 98504.

WEST VIRGINIA

Director, Consumer Protection, West Vir-
ginia Department of Labor, State Capitol,
1800 Washington Street East, Charleston,
WV 25305.

WISCONSIN

Chief Engineer, Safety and Buildings Divi-
sion, Wisconsin Department of Industry,
Labor and Human Relations, 201 East
Washington Avenue, Madison, WI 53707.

WYOMING

Director, Division of Markets and Industry,
Wyoming State Department of Agri-
culture, 308 Capitol, Cheyenne, WY 82001.

[43 FR 26579, June 21, 1978]

41 CFR Ch. 101 (7-1-01 Edition)

**Subpart 101-45.49—Illustrations of
Forms**

SOURCE: 42 FR 40857, Aug. 12, 1977, unless
otherwise noted.

EDITORIAL NOTE: The forms illustrated in
subpart 101-45.49 are filed as part of the
original document.

§ 101-45.4900 Scope of subpart.

This subpart illustrates forms pre-
scribed or available for use in connec-
tion with subject matter covered in
part 101-45.

§ 101-45.4901 Standard forms.

(a) Standard forms illustrated in this
section show their text, format, and ar-
rangement, and provide a ready source
of reference.

(b) Standard forms illustrated in this
§ 101-45.4901 may be obtained by sub-
mitting a requisition in FEDSTRIP/
MILSTRIP format to the GSA regional
office providing support to the request-
ing activity.

**§ 101-45.4901-28 Standard Form 28, Af-
fidavit of Individual Surety.**

**§ 101-45.4901-97 Standard Form 97,
The United States Government Cer-
tificate to Obtain Title to a Vehicle.**

**§ 101-45.4901-97-1 Instructions for use
of Standard Form 97.**

**§ 101-45.4901-114 Standard Form 114,
Sale of Government Property—Bid
and Award.**

**§ 101-45.4901-114A Standard Form
114A, Sale of Government Prop-
erty—Item Bid Page—Sealed Bid.**

**§ 101-45.4901-114B Standard Form
114B, Sale of Government Prop-
erty—Item Bid Page—Sealed Bid.**

Federal Property Management Regulations

§ 101-45.4903

§ 101-45.4901-114C Standard Form 114C, Sale of Government Property—General Sale Terms and Conditions.

§ 101-45.4901-150 Standard Form 150, Deposit Bond—Individual Invitation, Sale of Government Personal Property.

§ 101-45.4901-114C-1 Standard Form 114C-1, Sale of Government Property—Special Sealed Bid Conditions.

§ 101-45.4901-151 Standard Form 151, Deposit Bond—Annual, Sale of Government Personal Property.

§ 101-45.4901-114C-2 Standard Form 114C-2, Sale of Government Property—Special Sealed Bid—Term Conditions.

§ 101-45.4902 GSA forms.

(a) GSA forms in this section show their text, format, and arrangement and provide a ready source of reference.

(b) GSA forms in this section may be obtained initially from the General Service Administration, National Forms and Publications Center, 4900 South Hemphill Street, Warehouse No. 4, Dock No. 1, Fort Worth, Texas 76115. Agency regional or field offices should submit future requirements to their Washington headquarters office which will forward consolidated annual requirements to the General Services Administration (CAIR), Washington, DC 20405.

§ 101-45.4901-114C-3 Standard Form 114C-3, Sale of Government Property—Special Spot Bid Conditions.

§ 101-45.4901-114C-4 Standard Form 114C-4, Sale of Government Property—Special Auction Conditions.

§ 101-45.4901-114D Standard Form 114D, Sale of Government Property—Amendment of Invitation for Bids/Modification of Contract.

[42 FR 40857, Aug. 12, 1977, as amended at 53 FR 16125, May 5, 1988]

§ 101-45.4901-114E Standard Form 114E, Sale of Government Property—Negotiated Sales Contract.

§ 101-45.4902-27 GSA Form 27, Notice of Award (Sale of Government-Owned Personal Property).

§ 101-45.4901-114F Standard Form 114F, Sale of Government Property—Item Bid Page—Spot Bid or Auction.

§ 101-45.4902-27A GSA Form 27A, Notice of Award—Continuation.

§ 101-45.4901-126 Standard Form 126, Report of Personal Property for Sale.

§ 101-45.4903 Optional forms.

Optional forms illustrated in this §101-45.4903 show their text, format, and arrangement and provide a ready source of reference. The numbers in this subsection correspond with the Optional form numbers. Optional forms illustrated in this §101-45.4903 may be obtained by submitting a requisition in FEDSTRIP/MILSTRIP format to the GSA regional office providing support to the requesting activity.

§ 101-45.4901-126A Standard Form 126A, Report of Personal Property for Sale (Continuation Sheet).

§ 101-45.4903-15

§ 101-45.4903-15 Optional Form 15, poster, Sale of Government Property.

§ 101-45.4903-16 Optional Form 16, Sales Slip, Sale of Government Personal Property.

§ 101-45.4903-20 Optional Form 20, Notice to Surety—Deposit Bond—Annual Sale of Government Personal Property.

PART 101-46—REPLACEMENT OF PERSONAL PROPERTY PURSUANT TO THE EXCHANGE/SALE AUTHORITY

Sec.

- 101-46.000 Why should executive agencies use the exchange/sale authority?
- 101-46.001 What is prescribed by this part?
- 101-46.002 What are the definitions of some of the key terms used in this part?
 - 101-46.002-1 Acquire.
 - 101-46.002-2 Combat material.
 - 101-46.002-3 Exchange.
 - 101-46.002-4 Exchange/sale.
 - 101-46.002-5 Executive agency.
 - 101-46.002-6 Federal agency.
 - 101-46.002-7 Historic item.
 - 101-46.002-8 Replacement.
 - 101-46.002-9 Similar.
- 101-46.003 How do you request deviations from this part, and who can approve them?

Subpart 101-46.1 [Reserved]

Subpart 101-46.2—Exchange or Sale Determination

- 101-46.200 How do you determine whether to do an exchange or a sale?
- 101-46.201 When must you make a reimbursable transfer to another Federal agency?
- 101-46.202 To what other organizations may you make a reimbursable transfer?
- 101-46.203 What are the conditions for a reimbursable transfer?
- 101-46.204 What prohibitions and necessary conditions apply to the exchange/sale of personal property?
- 101-46.205 What special exceptions apply to the exchange/sale authority?

Subpart 101-46.3—Exchange/Sale Methods

- 101-46.300 What are the exchange methods?
- 101-46.301 What are the sales methods?
- 101-46.302 What are the accounting requirements for the proceeds of sale?

AUTHORITY: Sec. 205(c), 63 Stat. 390 (40 U.S.C. 486(c)).

41 CFR Ch. 101 (7-1-01 Edition)

SOURCE: 63 FR 5893, Feb. 5, 1998, unless otherwise noted.

§ 101-46.000 Why should executive agencies use the exchange/sale authority?

To reduce the agencies' need for additional funding for the acquisition of replacement personal property. If an agency has personal property that needs to be replaced, it can exchange or sell that property and apply the exchange allowance or sales proceeds to the acquisition of similar replacement property. Using the exchange/sale authority also enables agencies to avoid the costs (e.g., administrative and storage) associated with holding the property and processing it through the normal disposal cycle, i.e., reutilization by other Federal agencies, donation to eligible non-Federal public or non-profit organizations, sale to the public, or abandonment or destruction. By contrast, if the holding agency does not use the exchange/sale authority but instead reports the property to be replaced as excess, any sales proceeds are forwarded to the miscellaneous receipts account at the United States Treasury and are not available to the agency disposing of the property.

§ 101-46.001 What is prescribed by this part?

Provisions for use by you (an executive agency) when using the exchange/sale authority of section 201(c) of the Federal Property and Administrative Services Act of 1949, 63 Stat. 384, as amended (40 U.S.C. 481(c)). This part applies to all personal property owned by executive agencies worldwide. For the exchange/sale of aircraft parts and hazardous materials, you must meet the requirements in this part and in parts 101-37 and 101-42 of this chapter, respectively.

§ 101-46.002 What are the definitions of some of the key terms used in this part?

§ 101-46.002-1 Acquire.

To procure or otherwise obtain personal property, including by lease.

Federal Property Management Regulations

§ 101-46.200

§ 101-46.002-2 **Combat material.**

Arms, ammunition, and implements of war listed in the U.S. munitions list (22 CFR part 121).

§ 101-46.002-3 **Exchange.**

To replace personal property by trade or trade-in with the supplier of the replacement property.

§ 101-46.002-4 **Exchange/sale.**

To exchange or sell non-excess, non-surplus personal property and apply the exchange allowance or proceeds of sale in whole or in part payment for the acquisition of similar property.

§ 101-46.002-5 **Executive agency.**

Any executive department or independent establishment in the executive branch of the Government, including any wholly owned Government corporation.

§ 101-46.002-6 **Federal agency.**

Any executive agency or any establishment in the legislative or judicial branch of the Government (except the Senate, the House of Representatives, and the Architect of the Capitol and any activities under his/her direction).

§ 101-46.002-7 **Historic item.**

Property having added value for display purposes because its historical significance is greater than its fair market value for continued use. Items that are commonly available and remain in use for their intended purpose, such as military aircraft still in use by active or reserve units, are not historic items.

§ 101-46.002-8 **Replacement.**

The process of acquiring property to be used in place of property which is still needed but will no longer adequately perform all the tasks for which it is used.

§ 101-46.002-9 **Similar.**

Where the acquired item and replaced item:

- (a) Are identical; or
- (b) Are designed and constructed for the same purpose; or

(c) Both constitute parts or containers for identical or similar end items; or

(d) Both fall within a single Federal Supply Classification (FSC) group of property that is eligible for handling under the exchange/sale authority.

§ 101-46.003 **How do you request deviations from this part, and who can approve them?**

(a) General provisions for deviations from the Federal Property Management Regulations are found in §101-1.110 of this chapter. Provisions for deviations from the regulations in this part are presented in this section.

(b) To request deviations from this part, you must submit a complete written justification to the General Services Administration (GSA), Office of Governmentwide Policy, Office of Transportation and Personal Property (MT), Washington, DC 20405. Only the Administrator of General Services (or designee) may grant deviations. Although the Administrator can approve deviations from most of the provisions in this part, he/she cannot approve deviations from provisions that are mandated by statute, i.e., the requirement at 101-46.204(b)(1) that the property exchanged or sold is similar to the property acquired, and the requirement at 101-46.204(b)(2) that the property exchanged or sold is not excess or surplus.

Subpart 101-46.1 [Reserved]

Subpart 101-46.2—Exchange or Sale Determination

§ 101-46.200 **How do you determine whether to do an exchange or a sale?**

(a) You must determine which method—exchange or sale—will provide the greater return for the Government. When estimating the return under each method, consider all administrative and overhead costs.

(b) If the exchange allowance or estimated sales proceeds for property would be unreasonably low, you should process the property according to the regulations in Part 101-43 (Utilization of Personal Property) or Subpart 101-45.9 (Abandonment or Destruction of

§ 101-46.201

Personal Property) of this subchapter, as applicable.

§ 101-46.201 When must you make a reimbursable transfer to another Federal agency?

If you have property to replace which is eligible for exchange/sale, you should, to the maximum extent practicable, first solicit Federal agencies known to use or distribute such property and, if an agency wants it, arrange for a reimbursable transfer. Property that meets the replacement standards prescribed in subpart 101-25.4 of this chapter is not subject to this requirement.

§ 101-46.202 To what other organizations may you make a reimbursable transfer?

The Senate, the House of Representatives, the Architect of the Capitol and any activities under the Architect's direction, the District of Columbia, and mixed-ownership Government corporations.

§ 101-46.203 What are the conditions for a reimbursable transfer?

When transferring property, you must:

- (a) Do so under terms mutually agreeable to you and the recipient; and
- (b) Not require reimbursement of an amount greater than the estimated fair market value of the transferred property; and
- (c) Apply the transfer proceeds in whole or part payment for property acquired to replace the transferred property.

§ 101-46.204 What prohibitions and necessary conditions apply to the exchange/sale of personal property?

(a) You must not use the exchange/sale authority for:

(1) The following FSC groups of personal property:

- 10 Weapons.
- 11 Nuclear ordnance.
- 12 Fire control equipment.
- 14 Guided missiles.
- 15 Aircraft and airframe structural components, except FSC class 1560 Airframe Structural Components.
- 42 Firefighting, rescue, and safety equipment.
- 44 Nuclear reactors (FSC class 4472 only).

41 CFR Ch. 101 (7-1-01 Edition)

- 51 Hand tools.
- 54 Prefabricated structure and scaffolding.
- 68 Chemicals and chemical products, except medicinal chemicals.
- 71 Furniture.
- 84 Clothing, individual equipment, and insignia.

(2) Materials in the National Defense Stockpile (50 U.S.C. 98-98h) or the Defense Production Act inventory (50 U.S.C. App. 2093).

(3) Nuclear Regulatory Commission-controlled materials unless you meet the requirements of §101-42.1102-4 of this subchapter.

(4) Controlled substances, unless you meet the requirements of §101-42.1102-3 of this subchapter.

(5) Scrap materials, except in the case of scrap gold for fine gold.

(6) Property which was originally acquired as excess or forfeited property or from another source other than new procurement, unless such property has been in official use by the acquiring agency for at least 1 year. You may exchange or sell forfeited property in official use for less than 1 year if the head of your agency determines that a continuing valid requirement exists, but the specific item in use no longer meets that requirement, and that exchange or sale meets all other requirements of this part.

(7) Property that is dangerous to public health or safety without first rendering such property innocuous or providing for adequate safeguards as part of the exchange/sale.

(8) Combat material without demilitarizing it in accordance with applicable regulations.

(9) Flight Safety Critical Aircraft Parts unless you meet the provisions of §101-37.610 of this chapter.

(10) Acquisition of unauthorized replacement property.

(11) Acquisition of replacement property which violates:

- (i) Any restriction on procurement of a commodity or commodities; or
- (ii) Any replacement policy or standard prescribed by the President, the Congress, or the Administrator of General Services; or
- (iii) Any contractual obligation.

(b) You may use the exchange/sale authority only if you meet all of the following conditions:

Federal Property Management Regulations

§ 101-46.302

(1) The property exchanged or sold is similar to the property acquired; and

(2) The property exchanged or sold is not excess or surplus, and the property acquired is needed for approved programs; and

(3) The number of items acquired must equal the number of items exchanged or sold unless:

(i) The item(s) acquired perform all or substantially all of the tasks for which the item(s) exchanged or sold would otherwise be used; or

(ii) The item(s) acquired and the item(s) exchanged or sold meet the test for similarity specified at §101-46.002-9(iii) in that they are a part(s) or container(s) for identical or similar end items; and

(4) The property exchanged or sold was not acquired for the principal purpose of exchange or sale; and

(5) You document at the time of exchange or sale (or at the time of acquisition if it precedes the sale):

(i) That the exchange allowance or sale proceeds will be applied to the acquisition of replacement property; and

(ii) For any property exchanged or sold under this part, the pertinent Federal Supply Classification (FSC) Group, the number of items, the original acquisition cost, the exchange allowance or sales proceeds (as applicable), and the source from which the property was originally acquired i.e., new procurement, excess, forfeiture, or another source other than new procurement. These data, aggregated at the agency level, may be requested by GSA to evaluate use of the exchange/sale authority.

§101-46.205 What special exceptions apply to the exchange/sale authority?

(a) You may exchange books and periodicals in your libraries for other books and periodicals, without monetary appraisal or detailed listing or reporting.

(b) In acquiring items for historical preservation or display at Federal museums, you may exchange historic items in the museum property account without regard to the FSC group or the requirement in §101-46.204(b)(3), provided the exchange transaction is documented and certified by the head of

your agency to be in the best interests of the Government and all other provisions of this part are met. The documentation must contain a determination that the item exchanged and the item acquired are historic items.

Subpart 101-46.3—Exchange/Sale Methods

§101-46.300 What are the exchange methods?

Exchange of property may be accomplished by either of the following two methods:

(a) The supplier (e.g., a Government agency, commercial or private organization, or an individual) delivers the replacement property to one of your organizational units and removes the property being replaced from that same organizational unit. This is the normal manner of exchange.

(b) The supplier delivers the replacement property to one of your organizational units and removes the property being replaced from a different organizational unit.

§101-46.301 What are the sales methods?

(a) You must use the methods, terms, and conditions of sale, and the forms prescribed in §101-45.304 of this subchapter in the sale of property being replaced, except that the provisions of §101-45.304-2(a) of this subchapter regarding negotiated sales are not applicable. Section 3709, Revised Statutes (41 U.S.C. 5), specifies the following conditions under which property being replaced can be sold by negotiation, subject to obtaining such competition as is feasible:

(1) The reasonable value involved in the contract does not exceed \$500, or

(2) Otherwise authorized by law.

(b) You may sell property being replaced by negotiation at fixed prices in accordance with the provisions of §101-45.304-2(b) of this subchapter.

§101-46.302 What are the accounting requirements for the proceeds of sale?

Except as otherwise authorized by law, you must account for proceeds from sales of personal property disposed of under this part in accordance

Pt. 101-47

41 CFR Ch. 101 (7-1-01 Edition)

with the General Accounting Office Policy and Procedures Manual for Guidance of Federal Agencies, Title 7, Fiscal Procedures, Section 5.5D.

PART 101-47—UTILIZATION AND DISPOSAL OF REAL PROPERTY

Sec.

101-47.000 Scope of part.

Subpart 101-47.1—General Provisions

- 101-47.100 Scope of subpart.
- 101-47.101 Applicability.
- 101-47.102 [Reserved]
- 101-47.103 Definitions.
 - 101-47.103-1 Act.
 - 101-47.103-2 GSA.
 - 101-47.103-3 Airport.
 - 101-47.103-4 [Reserved]
 - 101-47.103-5 Decontamination.
 - 101-47.103-6 Disposal agency.
 - 101-47.103-7 Holding agency.
 - 101-47.103-8 Industrial property.
 - 101-47.103-9 Landing area.
 - 101-47.103-10 Management.
 - 101-47.103-11 Protection.
 - 101-47.103-12 Real property.
 - 101-47.103-13 Related personal property.
 - 101-47.103-14 Other terms defined in the Act.
 - 101-47.103-15 Other terms.

Subpart 101-47.2—Utilization of Excess Real Property

- 101-47.200 Scope of subpart.
- 101-47.201 General provisions of subpart.
 - 101-47.201-1 Policy.
 - 101-47.201-2 Guidelines.
 - 101-47.201-3 Lands withdrawn or reserved from the public domain.
 - 101-47.201-4 Transfers under other laws.
- 101-47.202 Reporting of excess real property.
 - 101-47.202-1 Reporting requirements.
 - 101-47.202-2 Report forms.
 - 101-47.202-3 Submission of reports.
 - 101-47.202-4 Exceptions to reporting.
 - 101-47.202-5 Reporting after submissions to the Congress.
 - 101-47.202-6 Reports involving the public domain.
 - 101-47.202-7 Reports involving contaminated property.
 - 101-47.202-8 Notice of receipt.
 - 101-47.202-9 Expense of protection and maintenance.
 - 101-47.202-10 Examination for acceptability.
- 101-47.203 Utilization.
 - 101-47.203-1 Reassignment of real property by the agencies.
 - 101-47.203-2 Transfer and utilization.
 - 101-47.203-3 Notification of agency requirements.
 - 101-47.203-4 Real property excepted from reporting.

- 101-47.203-5 Screening of excess real property.
- 101-47.203-6 Designation as personal property.
 - 101-47.203-7 Transfers.
 - 101-47.203-8 Temporary utilization.
 - 101-47.203-9 Non-Federal interim use of property.
 - 101-47.203-10 Withdrawals.
- 101-47.204 Determination of surplus.
 - 101-47.204-1 Reported property.
 - 101-47.204-2 Property excepted from reporting.

Subpart 101-47.3—Surplus Real Property Disposal

- 101-47.300 Scope of subpart.
- 101-47.301 General provisions of subpart.
 - 101-47.301-1 Policy.
 - 101-47.301-2 Applicability of antitrust laws.
 - 101-47.301-3 Disposals under other laws.
 - 101-47.301-4 Credit disposals and leases.
- 101-47.302 Designation of disposal agencies.
 - 101-47.302-1 General.
 - 101-47.302-2 Holding agency.
 - 101-47.302-3 General Services Administration.
 - 101-47.303 Responsibility of disposal agency.
 - 101-47.303-1 Classification.
 - 101-47.303-2 Disposals to public agencies.
 - 101-47.303-2a Notice for zoning purposes.
 - 101-47.303-3 Studies.
 - 101-47.303-4 Appraisal.
 - 101-47.304 Advertised and negotiated disposals.
 - 101-47.304-1 Publicity.
 - 101-47.304-2 Soliciting cooperation of local groups.
 - 101-47.304-3 Information to interested persons.
 - 101-47.304-4 Invitation for offers.
 - 101-47.304-5 Inspection.
 - 101-47.304-6 Submission of offers.
 - 101-47.304-7 Advertised disposals.
 - 101-47.304-8 [Reserved]
 - 101-47.304-9 Negotiated disposals.
 - 101-47.304-10 Disposals by brokers.
 - 101-47.304-11 Documenting determinations to negotiate.
 - 101-47.304-12 Explanatory statements.
 - 101-47.304-13 Provisions relating to asbestos.
 - 101-47.304-14 Provisions relating to hazardous substance activity.
- 101-47.305 Acceptance of offers.
 - 101-47.305-1 General.
 - 101-47.305-2 Equal offers.
 - 101-47.305-3 Notice to unsuccessful bidders.
- 101-47.306 Absence of acceptable offers.
 - 101-47.306-1 Negotiations.
 - 101-47.306-2 Defense Industrial Reserve properties.
- 101-47.307 Conveyances.
 - 101-47.307-1 Form of deed or instrument of conveyance.

Federal Property Management Regulations

Pt. 101-47

- 101-47.307-2 Conditions in disposal instruments.
- 101-47.307-3 Distribution of conformed copies of conveyance instruments.
- 101-47.307-4 Disposition of title papers.
- 101-47.307-5 Title transfers from Government corporations.
- 101-47.307-6 Proceeds from disposals.
- 101-47.308 Special disposal provisions.
- 101-47.308-1 Power transmission lines.
- 101-47.308-2 Property for public airports.
- 101-47.308-3 Property for use as historic monuments.
- 101-47.308-4 Property for educational and public health purposes.
- 101-47.308-5 [Reserved]
- 101-47.308-6 Property for providing self-help housing or housing assistance.
- 101-47.308-7 Property for use as public park or recreation areas.
- 101-47.308-8 Property for displaced persons.
- 101-47.308-9 Property for correctional facility, law enforcement, or emergency management response purposes.
- 101-47.308-10 Property for port facility use.
- 101-47.309 Disposal of leases, permits, licenses, and similar instruments.
- 101-47.310 Disposal of structures and improvements on Government-owned land.
- 101-47.311 Disposal of residual personal property.
- 101-47.312 Non-Federal interim use of property.
- 101-47.313 Easements.
- 101-47.313-1 Disposal of easements to owner of servient estate.
- 101-47.313-2 Grants of easements in or over Government property.
- 101-47.314 Compliance.
- 101-47.314-1 General.
- 101-47.314-2 Extent of investigations.

Subpart 101-47.4—Management of Excess and Surplus Real Property

- 101-47.400 Scope of subpart.
- 101-47.401 General provisions of subpart.
- 101-47.401-1 Policy.
- 101-47.401-2 Definitions.
- 101-47.401-3 Taxes and other obligations.
- 101-47.401-4 Decontamination.
- 101-47.401-5 Improvements or alterations.
- 101-47.401-6 Interim use and occupancy.
- 101-47.402 Protection and maintenance.
- 101-47.402-1 Responsibility.
- 101-47.402-2 Expense of protection and maintenance.
- 101-47.403 Assistance in disposition.

Subpart 101-47.5—Abandonment, Destruction, or Donation to Public Bodies

- 101-47.500 Scope of subpart.
- 101-47.501 General provisions of subpart.
- 101-47.501-1 Definitions.
- 101-47.501-2 Authority for disposal.
- 101-47.501-3 Dangerous property.

- 101-47.501-4 Findings.
- 101-47.502 Donations to public bodies.
- 101-47.502-1 Cost limitations.
- 101-47.502-2 Disposal costs.
- 101-47.503 Abandonment and destruction.
- 101-47.503-1 General.
- 101-47.503-2 Notice of proposed abandonment or destruction.
- 101-47.503-3 Abandonment or destruction without notice.

Subpart 101-47.6—Delegations

- 101-47.600 Scope of subpart.
- 101-47.601 Delegation to Department of Defense.
- 101-47.602 Delegation to the Department of Agriculture.
- 101-47.603 Delegations to the Secretary of the Interior.
- 101-47.604 Delegation to the Department of the Interior, the Department of Health and Human Services, and the Department of Education.

Subpart 101-47.7—Conditional Gifts of Real Property To Further the Defense Effort

- 101-47.700 Scope of subpart.
- 101-47.701 Offers and acceptance of conditional gifts.
- 101-47.702 Consultation with agencies.
- 101-47.703 Advice of disposition.
- 101-47.704 Acceptance of gifts under other laws.

Subpart 101-47.8—Identification of Unneeded Federal Real Property

- 101-47.800 Scope of subpart.
- 101-47.801 Standards.
- 101-47.802 Procedures.

Subpart 101-47.9 Use of Federal Real Property to Assist the Homeless

- 101-47.901 Definitions.
- 101-47.902 Applicability.
- 101-47.903 Collecting the information.
- 101-47.904 Suitability determination.
- 101-47.905 Real property reported excess to GSA.
- 101-47.906 Suitability criteria.
- 101-47.907 Determination of availability.
- 101-47.908 Public notice of determination.
- 101-47.909 Application process.
- 101-47.910 Action on approved applications.
- 101-47.911 Unsuitable properties.
- 101-47.912 No applications approved.

Subparts 101-47.10—101-47.48 [Reserved]

Subpart 101-47.49—Illustrations

- 101-47.4900 Scope of subpart.
- 101-47.4901 [Reserved]
- 101-47.4902 Standard Form 118, Report of Excess Real Property.

§ 101-47.000

- 101-47.4902-1 Standard Form 118a, Buildings, Structures, Utilities, and Miscellaneous Facilities.
- 101-47.4902-2 Standard Form 118b, Land.
- 101-47.4902-3 Standard Form 118c, Related Personal Property.
- 101-47.4902-4 Instructions for the preparation of Standard Form 118, and Attachments, Standard Forms 118a, 118b, and 118c.
- 101-47.4904 GSA Form 1334, Request for Transfer of Excess Real and Related Personal Property.
- 101-47.4904-1 Instructions for preparation of GSA Form 1334, Request for Transfer of Excess Real and Related Personal Property.
- 101-47.4905 Extract of statutes authorizing disposal of surplus real property to public agencies.
- 101-47.4906 Sample notice to public agencies of surplus determination.
- 101-47.4906a Attachment to notice sent to zoning authority.
- 101-47.4906b Paragraph to be added to letter sent to zoning authority.
- 101-47.4906-1 Sample letter for transmission of notice of surplus determination.
- 101-47.4906-2 Sample letter to a State single point of contact.
- 101-47.4907 List of Federal real property holding agencies.
- 101-47.4908 Excess profits covenant.
- 101-47.4909 Highest and best use.
- 101-47.4910 Field offices of Department of Health, Education, and Welfare.
- 101-47.4911 Outline for explanatory statements for negotiated sales.
- 101-47.4912 Regional offices of the Bureau of Outdoor Recreation, Department of the Interior.
- 101-47.4913 Outline for protection and maintenance of excess and surplus real property.
- 101-47.4914 Executive Order 12512.

AUTHORITY: 40 U.S.C. 486(c).

SOURCE: 29 FR 16126, Dec. 3, 1964, unless otherwise noted.

§ 101-47.000 Scope of part.

(a) This part prescribes the policies and methods governing the utilization and disposal of excess and surplus real property and related personal property within the States of the Union, the District of Columbia, the Commonwealth of Puerto Rico, American Samoa, Guam, the Trust Territory of the Pacific Islands, and the Virgin Islands.

(b) For more information on the utilization and disposal of real property, see 41 CFR parts 102-71 through 102-82.

41 CFR Ch. 101 (7-1-01 Edition)

To the extent that any policy statements in this part are inconsistent with the policy statements in 41 CFR parts 102-71 through 102-82, the policy statements in 41 CFR parts 102-71 through 102-82 are controlling.

[47 FR 4521, Feb. 1, 1982, as amended at 66 FR 5359, Jan. 18, 2001]

Subpart 101-47.1—General Provisions

§ 101-47.100 Scope of subpart.

This subpart sets forth the applicability of this part 101-47, and other introductory information.

§ 101-47.101 Applicability.

The provisions of this part 101-47 apply to all Federal agencies, except as may otherwise be specifically provided under each section or subpart.

§ 101-47.102 [Reserved]

§ 101-47.103 Definitions.

As used throughout this part 101-47, the following terms shall have the meanings as set forth in this subpart 101-47.1.

§ 101-47.103-1 Act.

The Federal Property and Administrative Services Act of 1949, 63 Stat. 377, as amended.

§ 101-47.103-2 GSA.

The General Services Administration, acting by or through the Administrator of General Services, or a designated official to whom functions under this part 101-47 have been delegated by the Administrator of General Services.

§ 101-47.103-3 Airport.

Any area of land or water which is used, or intended for use, for the landing and takeoff of aircraft, and any appurtenant areas which are used, or intended for use, for airport buildings or other airport facilities or rights-of-way, together with all airport buildings and facilities located thereon.

Federal Property Management Regulations

§ 101-47.103-12

§ 101-47.103-4 [Reserved]

§ 101-47.103-5 Decontamination.

The complete removal or destruction by flashing of explosive powders; the neutralizing and cleaning-out of acid and corrosive materials; the removal, destruction, or neutralizing of toxic, hazardous or infectious substances; and the complete removal and destruction by burning or detonation of live ammunition from contaminated areas and buildings.

[53 FR 29893, Aug. 9, 1988]

§ 101-47.103-6 Disposal agency.

The executive agency designated by the Administrator of General Services to dispose of surplus real property.

§ 101-47.103-7 Holding agency.

The Federal agency which has accountability for the property involved.

§ 101-47.103-8 Industrial property.

Any real property and related personal property which has been used or which is suitable to be used for manufacturing, fabricating, or processing of products; mining operations; construction or repair of ships and other waterborne carriers; power transmission facilities; railroad facilities; and pipeline facilities for transporting petroleum or gas.

§ 101-47.103-9 Landing area.

Any land or combination of water and land, together with improvements thereon and necessary operational equipment used in connection therewith, which is used for landing, take-off, and parking of aircraft. The term includes, but is not limited to, runways, strips, taxiways, and parking aprons.

§ 101-47.103-10 Management.

The safeguarding of the Government's interest in property, in an efficient and economical manner consistent with the best business practices.

§ 101-47.103-11 Protection.

The provisions of adequate measures for prevention and extinguishment of fires, special inspections to determine

and eliminate fire and other hazards, and necessary guards to protect property against thievery, vandalism, and unauthorized entry.

§ 101-47.103-12 Real property.

(a) Any interest in land, together with the improvements, structures, and fixtures located thereon (including prefabricated movable structures, such as Butler-type storage warehouses and quonset huts, and housetrailer with or without undercarriages), and appurtenances thereto, under the control of any Federal agency, except:

(1) The public domain;

(2) Lands reserved or dedicated for national forest or national park purposes;

(3) Minerals in lands or portions of lands withdrawn or reserved from the public domain which the Secretary of the Interior determines are suitable for disposition under the public land mining and mineral leasing laws;

(4) Lands withdrawn or reserved from the public domain but not including lands or portions of lands so withdrawn or reserved which the Secretary of the Interior, with the concurrence of the Administrator of General Services, determines are not suitable for return to the public domain for disposition under the general public land laws because such lands are substantially changed in character by improvements or otherwise; and

(5) Crops when designated by such agency for disposition by severance and removal from the land.

(b) Improvements of any kind, structures, and fixtures under the control of any Federal agency when designated by such agency for disposition without the underlying land (including such as may be located on the public domain, or lands withdrawn or reserved from the public domain, or lands reserved or dedicated for national forest or national park purposes, or on lands that are not owned by the United States) excluding, however, prefabricated movable structures, such as Butler-type storage warehouses and quonset huts, and housetrailer (with or without undercarriages).

(c) Standing timber and embedded gravel, sand, or stone under the control

§ 101-47.103-13

of any Federal agency whether designated by such agency for disposition with the land or by severance and removal from the land, excluding timber felled, and gravel, sand, or stone excavated by or for the Government prior to disposition.

[29 FR 16126, Dec. 3, 1964, as amended at 30 FR 11281, Aug. 2, 1965; 33 FR 8737, June 14, 1968]

§ 101-47.103-13 Related personal property.

Related personal property means any personal property:

(a) Which is an integral part of real property or is related to, designed for, or specially adapted to the functional or productive capacity of the real property and removal of this personal property would significantly diminish the economic value of the real property. Normally, common use items, including but not limited to general-purpose furniture, utensils, office machines, office supplies, or general-purpose vehicles, are not considered to be related personal property; or

(b) Which is determined by the Administrator of General Services to be related to the real property.

[46 FR 45951, Sept. 16, 1981]

§ 101-47.103-14 Other terms defined in the Act.

Other terms which are defined in the Act shall have the meanings given them by such Act.

§ 101-47.103-15 Other terms.

Other terms not applicable throughout this part are defined in the sections or subparts to which they apply.

Subpart 101-47.2—Utilization of Excess Real Property

§ 101-47.200 Scope of subpart.

(a) This subpart prescribes the policies and methods governing the reporting by executive agencies and utilization by Federal agencies of excess real property, including related personal property within the State of the Union, the District of Columbia, the Commonwealth of Puerto Rico, American Samoa, Guam, the Trust Territory of the Pacific Islands, and the Virgin Is-

41 CFR Ch. 101 (7-1-01 Edition)

lands. This subpart does not apply to the abandonment, destruction, or donation to public bodies, under section 202(h) of the Act (covered by subpart 101-47.5).

(b) The provisions of this subpart 101-47.2 shall not apply to asbestos on Federal property which is subject to section 120(h) of the Superfund Amendments and Reauthorization Act of 1986, Public Law 99-499.

[53 FR 29893, Aug. 9, 1988]

§ 101-47.201 General provisions of subpart.

§ 101-47.201-1 Policy.

It is the policy of the Administrator of General Services:

(a) To stimulate the identification and reporting by executive agencies of excess real property.

(b) To achieve the maximum utilization by executive agencies, in terms of economy and efficiency, of excess real property in order to minimize expenditures for the purchase of real property.

(c) To provide for the transfer of excess real property among Federal agencies, to mixed-ownership Government corporations, and to the municipal government of the District of Columbia.

[29 FR 16126, Dec. 3, 1964, as amended at 42 FR 40698, Aug. 11, 1977]

§ 101-47.201-2 Guidelines.

(a) Each executive agency shall:

(1) Survey real property under its control (including property assigned on a permit basis to other Federal agencies, or outleased to States, local governments, other public bodies, or private interests) at least annually to identify property which is not needed, underutilized, or not being put to optimum use. When other needs for the property are identified or recognized, the agency shall determine whether continuation of the current use or another Federal or other use would better serve the public interest, considering both the agency's needs and the property's location. In conducting each review, agencies shall be guided by § 101-47.801(b), other applicable General Services Administration regulations, and such criteria as may be established by the Federal Property Council;

Federal Property Management Regulations

§ 101-47.201-2

(2) Maintain its inventory of real property at the absolute minimum consistent with economical and efficient conduct of the affairs of the agency; and

(3) Promptly report to GSA real property which it has determined to be excess.

(b) Each executive agency shall, so far as practicable, pursuant to the provisions of this subpart, fulfill its needs for real property by utilization of excess real property.

(c) To preclude the acquisition by purchase of real property when excess or surplus property of another Federal agency may be available which would meet the need, each executive agency shall notify GSA of its needs and ascertain whether any such property is available. However, in specific instances where the agency's proposed acquisition of real property is dictated by such factors as exact geographical location, topography, engineering, or similar characteristics which limit the possible use of other available property, the notification shall not be required. For example, for a dam site or reservoir area or the construction of a generating plant or a substation specific lands are needed and, ordinarily, no purpose would be served by such notification.

(d) In every case of a proposed transfer of excess real property, the paramount consideration shall be the validity and appropriateness of the requirement upon which the proposal is based.

(1) A proposed transfer should not establish a new program of an executive agency which has never been reflected in any previous budget submission or congressional action; nor should it substantially increase the level of an agency's existing programs beyond that which has been contemplated in the President's budget or by the Congress.

(2) Before requesting a transfer of excess real property, an executive agency should:

(i) Screen the holdings of the bureaus or other organizations within the agency to determine whether the new requirement can be met through improved utilization. Any utilization, however, must be for purposes that are consistent with the highest and best

use of the property under consideration; and

(ii) Review all real property under its accountability which it has assigned on a permit basis to other Federal agencies, or outleased to States, local governments, other public bodies, or private interests and terminate the permit or lease for any property, or portion thereof, that is suitable for the proposed need whenever such termination is not prohibited by the terms of the permit or lease.

(3) Property found to be available under §101-47.201-2(d)(2) (i) or (ii), should be utilized for the proposed need in lieu of requesting a transfer of excess real property. Reassignments of such property within the agency should be made in appropriate cases.

(4) The appraised fair market value of the excess real property proposed for transfer should not substantially exceed the probable purchase price of other real property which would be suitable for the intended purpose.

(5) The size and quantity of excess real property to be transferred should be limited to the actual requirements. Other portions of an excess installation which can be separated should be withheld from transfer and made available for disposal to other agencies or to the public.

(6) Consideration should be given to the design, layout, geographic location, age, state of repair, and expected maintenance costs of excess real property proposed for transfer. It should be clearly demonstrated that the transfer will prove more economical over a sustained period of time than acquisition of a new facility specifically planned for the purpose.

(7) Excess real property should not be permanently transferred to agencies for programs which appear to be scheduled for substantial curtailment or termination. In such cases, the property may be temporarily transferred on a conditional basis, with an understanding that the property will be released for further Federal utilization or disposal as surplus property, at a time agreed upon when the transfer is arranged (see §101-47.203-8).

(e) Excess real property of a type which may be used for office, storage, and related purposes normally will be

§ 101-47.201-3

assigned by, or at the direction of, GSA for use to the requesting agency in lieu of being transferred to the agency.

(f) Federal agencies which normally do not require real property, other than for office, storage, and related purposes, or which may not have statutory authority to acquire such property, may obtain the use of excess real property for an approved program when authorized by GSA.

[29 FR 16126, Dec. 3, 1964, as amended at 39 FR 11281, Sept. 2, 1965; 37 FR 5029, Mar. 9, 1972; 40 FR 12078, Mar. 17, 1975]

§ 101-47.201-3 Lands withdrawn or reserved from the public domain.

(a) Agencies holding lands withdrawn or reserved from the public domain, which they no longer need, shall send to the GSA regional office for the region in which the lands are located an information copy of each notice of intention to relinquish filed with the Department of the Interior (43 CFR part 2372, *et seq.*).

(b) Section 101-47.202-6 prescribes the procedure for reporting to GSA as excess property, certain lands or portions of lands withdrawn or reserved from the public domain for which such notices have been filed with the Department of the Interior.

[29 FR 16126, Dec. 3, 1964, as amended at 42 FR 40698, Aug. 11, 1977]

§ 101-47.201-4 Transfers under other laws.

Pursuant to section 602(c) of the Act, transfers of real property shall not be made under other laws, but shall be made only in strict accordance with the provisions of this subpart unless the Administrator of General Services, upon written application by the disposal agency, shall determine in each case that the provisions of any such other law, pursuant to which a transfer is proposed to be made, are not inconsistent with the authority conferred by this Act. The provisions of this section shall not apply to transfers of real property authorized to be made by section 602(d) of the Act or by any special statute which directs or requires an executive agency named therein to transfer or convey specifically described real property in accordance with the provisions of such statute.

41 CFR Ch. 101 (7-1-01 Edition)

§ 101-47.202 Reporting of excess real property.

§ 101-47.202-1 Reporting requirements.

Each executive agency shall report to GSA, pursuant to the provisions of this section, all excess real property except as provided in §101-47.202-4. Reports of excess real property shall be based on the agency's official real property records and accounts.

(a) All excess related personal property shall be reported as a part of the same report covering the excess real property.

(b) Upon request of the Administrator of General Services, executive agencies shall institute specific surveys to determine that portion of real property, including unimproved property, under their control which might be excess and suitable for office, storage, and related facilities, and shall report promptly to the Administrator of General Services as soon as each survey is completed.

§ 101-47.202-2 Report forms.

Reports of excess real property and related personal property shall be prepared on Standard Form 118, Report of Excess Real Property (see §101-47.4902), and accompanying Standard Form 118a, Buildings Structures, Utilities, and Miscellaneous Facilities, Schedule A (§101-47.4902-1); Standard Form 118b, Land, Schedule B (see §101-47.402-2); and Standard Form 118c, Related Personal Property, Schedule C (see §101-47.4902-3). Instructions for the preparation of Standard Forms 118, 118a, 118b, and 118c are set forth in §101-47.4902-4.

(a) Property for which the holding agency is designated as the disposal agency under the provisions of §101-47.302-2 and which is required to be reported to GSA under the provisions of this section shall be reported on Standard Form 118, without the accompanying Schedules A, B, and C, unless the holding agency requests GSA to act as disposal agency and a statement to that effect is inserted in Block 18, Remarks, of Standard Form 118.

(b) In all cases where Government-owned land is reported, there shall be attached to and made a part of Standard Form 118 (original and copies

Federal Property Management Regulations

§ 101-47.202-2

thereof) a report prepared by a qualified employee of the holding agency on the Government's title to the property based upon his review of the records of the agency. The report shall recite:

- (1) The description of the property.
- (2) The date title vested in the United States.
- (3) All exceptions, reservations, conditions, and restrictions, relating to the title acquired.
- (4) Detailed information concerning any action, thing, or circumstance that occurred from the date of the acquisition of the property by the United States to the date of the report which in any way affected or may have affected the right, title, and interest of the United States in and to the real property (together with copies of such legal comments or opinions as may be contained in the file concerning the manner in which and the extent to which such right, title, or interest may have been affected). In the absence of any such action, thing, or circumstance, a statement to that effect shall be made a part of the report.
- (5) The status of civil and criminal jurisdiction over the land that is peculiar to the property by reason of it being Government-owned land. In the absence of any special circumstances, a statement to that effect shall be made a part of the report.
- (6) Detailed information regarding any known flood hazards or flooding of the property and, if located in a floodplain or wetlands, a listing of and citations to those uses that are restricted under identified Federal, State, or local regulations as required by Executive Orders 11988 and 11990 of May 24, 1977.
- (7) The specific identification and description of fixtures and related personal property that have possible historic or artistic value.
- (8) The historical significance of the property, if any, and whether the property is listed, is eligible for, or has been nominated for listing in the National Register of Historic Places or is in proximity to a property on the National Register. If the holding agency is aware of any effort by the public to have the property listed on the National Register, this information should be included.

(9) To the extent such information is reasonably available or ascertainable from agency files, personnel, and other inquiry, a description of the type, location and condition of asbestos incorporated in the construction, repair, or alteration of any building or improvement on the property (e.g., fireproofing, pipe insulation, etc.) and a description of any asbestos control measures taken for the property. To assist GSA in considering the disposal options for the property, agencies shall also provide to GSA any available indication of costs and/or time necessary to remove all or any portion of the asbestos-containing materials. Agencies are not required to conduct any specific studies and/or tests to obtain this information. (See also §101-47.200(b).)

(10) With respect to hazardous substance activity on the property:

(i) A statement indicating whether or not, during the time the property was owned by the United States, any hazardous substance activity, as defined by regulations issued by the Environmental Protection Agency at 40 CFR part 373, took place on the property. Hazardous substance activity includes situations where any hazardous substance was stored for one year or more, known to have been released, or disposed of on the property. Agencies reporting such property shall review the regulations issued by the Environmental Protection Agency at 40 CFR part 373 for details on the information required.

(ii) If such activity took place, the reporting agency must include information on the type and quantity of such hazardous substance and the time at which such storage, release, or disposal took place. In addition to the specific information on the type and quantity of the hazardous substance, the reporting agency shall also advise the disposal agency if all remedial action necessary to protect human health and the environment with respect to any such substance remaining on the property has been taken before the date of the property was reported excess. If such action has not been taken, the reporting agency shall advise the disposal agency when such action will be completed.

(iii) If no such activity took place, the reporting agency must include a statement:

The (reporting agency) has determined, accordance with regulations issued by the Environmental Protection Agency at 40 CFR part 373, that there is no evidence to indicate that hazardous substance activity took place on the property during the time the property was owned by the United States.

(c) There shall be transmitted with Standard Form 118:

(1) A legible, reproducible copy of all instruments in possession of the agency which affect the right, title, or interest of the United States in the property reported or the use and operation of such property (including agreements covering and licenses to use, any patents, processes, techniques, or inventions). In cases where the agency considers it to be impracticable to transmit the abstracts of title and related title evidence, such documents need not be transmitted; however, the name and address of the custodian of such documents shall be stated in the title report referred to in §101-47.202-2(b) and they shall be furnished if requested by GSA;

(2) Any appraisal reports in the possession of the holding agency of the fair market value or the fair annual rental of the property reported; and

(3) A certification by a responsible person that the property does or does not contain polychlorinated biphenyl (PCB) transformers or other equipment regulated by the Environmental Protection Agency under 40 CFR part 761. If the property does contain any equipment subject to 40 CFR part 761, the certification must include an assurance on behalf of the holding agency that each item of such equipment is now and will be maintained in a state of compliance with such regulations until disposal of the property.

[29 FR 16126, Dec. 3, 1964, as amended at 34 FR 8166, May 24, 1969; 40 FR 22256, May 22, 1975; 44 FR 19406, Apr. 3, 1979; 52 FR 46467, Dec. 8, 1987; 53 FR 29893, Aug. 9, 1988; 56 FR 15048, Apr. 15, 1991]

§ 101-47.202-3 Submission of reports.

Reports of excess shall be filed with the regional office of GSA for the region in which the excess property is located, as follows:

(a) Government-owned real property and related personal property shall be reported by the holding agencies 90-calendar days in advance of the date such excess property shall become available for transfer to another Federal agency or for disposal. Where the circumstances will not permit excess real property and related personal property to be reported a full 90-calendar days in advance of the date it will be available, the report shall be made as far in advance of such date as possible.

(b) Leasehold interests in real property determined to be excess shall be reported at least 60-calendar days prior to the date on which notice of termination or cancellation is required by the terms of the instrument under which the property is occupied.

(c) All reports submitted by the Department of Defense shall bear the certification "This property has been screened against the known needs of the Department of Defense." All reports submitted by civilian agencies shall bear the certification "This property has been screened against the known needs of the holding agency."

§ 101-47.202-4 Exceptions to reporting.

(a) A holding agency shall not report to GSA leased space assigned to the agency by GSA and determined by the agency to be excess.

(b) Also, except for those instances set forth in §101-47.202-4(c) a holding agency shall not report to GSA property used, occupied, or controlled by the Government under a lease, permit, license, easement, or similar instrument when:

(1) The lease or other instrument is subject to termination by the grantor or owner of the premises within nine months;

(2) The remaining term of the lease or other instrument, including renewal rights, will provide for less than nine months of use and occupancy;

(3) The term of the lease or other instrument would preclude transfer to, or use by, another Federal agency or disposal to a third party; or

(4) The lease or other instrument provides for use and occupancy of space

Federal Property Management Regulations

§ 101-47.202-9

for office, storage, and related facilities, which does not exceed a total of 2,500 sq. feet.

(c) Property, which otherwise would not be reported because it falls within the exceptions set forth in §101-47.202-4(b) shall be reported:

(1) If there are Government owned improvements located on the premises; or

(2) If the continued use, occupancy, or control of the property by the Government is needful for the operation, production, or maintenance of other property owned or controlled by the Government that has been reported excess or is required to be reported to GSA under the provisions of this section.

§ 101-47.202-5 Reporting after submissions to the Congress.

Reports of excess covering property of the military departments and of the Office of Emergency Planning prepared after the expiration of 30 days from the date upon which a report of the facts concerning the reporting of such property was submitted to the Committees on Armed Services of the Senate and House of Representatives, 10 U.S.C. 2662 and the Act of August 10, 1956, 70A Stat. 636, as amended (50 U.S.C. App. 2285), shall contain a statement that the requirements of the statute have been met.

§ 101-47.202-6 Reports involving the public domain.

(a) Agencies holding land withdrawn or reserved from the public domain which they no longer need, shall report on Standard Form 118, with appropriate Schedules A, B, and C, land or portions of land so withdrawn or reserved and the improvements thereon, if any, to the regional office of GSA for the region in which the lands are located when the agency has:

(1) Filed a notice of intention to relinquish with the Department of the Interior and sent a copy of the notice to the regional office of GSA (§101-47.201-3);

(2) Been notified by the Department of the Interior that the Secretary of the Interior, with the concurrence of the Administrator of General Services, has determined the lands are not suit-

able for return to the public domain for disposition under the general public land laws because the lands are substantially changed in character by improvements or otherwise; and

(3) Obtained from the Department of the Interior a report as to whether any agency (other than the holding agency) claims primary, joint, or secondary jurisdiction over the lands and whether the Department's records show the lands to be encumbered with any existing valid rights or privileges under the public land laws.

(b) Should the Department of the Interior determine that minerals in the lands are not suitable for disposition under the public land mining and mineral leasing laws, the Department will notify the appropriate regional office of GSA of such determination and will authorize the holding agency to include the minerals in its report to GSA.

(c) When reporting the property to GSA, a true copy of the notification (§101-47.202-6(a)(2)) and report (§101-47.202-6(a)(3)) shall be submitted as a part of the holding agency's report on the Government's legal title which shall accompany Standard Form 118.

§ 101-47.202-7 Reports involving contaminated property.

Any report of excess covering property which in its present condition is dangerous or hazardous to health and safety, shall state the extent of such contamination, the plans for decontamination, and the extent to which the property may be used without further decontamination. In the case of properties containing asbestos-containing materials and in lieu of the requirements of the foregoing provisions of §101-47.202-7, see subsection 101-47.202-2(b)(9).

[53 FR 28984, Aug. 9, 1988]

§ 101-47.202-8 Notice of receipt.

GSA shall promptly notify the holding agency of the date of receipt of each Report of Excess Real Property (Standard Form 118).

§ 101-47.202-9 Expense of protection and maintenance.

When there are expenses connected with the protection and maintenance

§ 101-47.202-10

of the property reported to GSA, the notice to the holding agency of the date of receipt (see §101-47.202-8) will indicate, if determinable, the date that the provisions of §101-47.402-2 will become effective. Normally this will be the date of the receipt of the report. If because of actions of the holding agency the property is not available for immediate disposition at the time of receipt of the report, the holding agency will be reminded in the notice that the period of its responsibility for the expense of protection and maintenance will be extended by the period of the delay.

[49 FR 1348, Jan. 11, 1984]

§ 101-47.202-10 Examination for acceptability.

Each report of excess shall be reviewed by GSA to ascertain whether the report was prepared in accordance with the provisions of this section. Within fifteen calendar days after receipt of a report, the holding agency shall be informed by letter of the findings of GSA.

(a) Where it is found that a report is adequate to the extent that GSA can proceed with utilization and disposal actions for the property, the report shall be accepted and the holding agency shall be informed of the date of such acceptance. However, the holding agency shall, upon request, promptly furnish such additional information or documents relating to the property as may be required by GSA to accomplish a transfer or a disposal.

(b) Where it is found that a report is insufficient to the extent that GSA would be unable to proceed with any utilization or disposal actions for the property, the report shall be returned and the holding agency shall be informed of the facts and circumstances that required the return of the report. The holding agency promptly shall take such action as may be appropriate to submit an acceptable report to GSA. Should the holding agency be unable to submit an acceptable report, the property shall be removed from under the provisions of § 101-47.402-2.

41 CFR Ch. 101 (7-1-01 Edition)

§ 101-47.203 Utilization.

§ 101-47.203-1 Reassignment of real property by the agencies.

Each executive agency shall, as far as practicable and within the policies expressed in this subpart 101-47.2, make reassignments of real property and related personal property under its control and jurisdiction among activities within the agency in lieu of acquiring such property from other sources.

[42 FR 40698, Aug. 11, 1977]

§ 101-47.203-2 Transfer and utilization.

Each executive agency shall, as far as practicable and within the policies expressed in this subpart 101-47.2, transfer excess real property under its control to other Federal agencies and to the organizations specified in §101-47.203-7, and shall fulfill its requirements for real property by obtaining excess real property from other Federal agencies. Transfers of property shall be made in accordance with the provisions of this subpart.

[42 FR 40698, Aug. 11, 1977]

§ 101-47.203-3 Notification of agency requirements.

Each executive agency shall notify the proper GSA regional office whenever real property is needed for an authorized program of the agency. The notice shall state the land area of the property needed, the preferred location or suitable alternate locations, and describe the type of property needed in sufficient detail to enable GSA to review its records of property that it knows will be reported excess by holding agencies, its inventory of excess property, and its inventory of surplus property, to ascertain whether any such property may be suitable for the needs of the agency. The agency shall be informed promptly by the GSA regional office as to whether or not any such property is available.

[33 FR 571, Jan. 17, 1968]

§ 101-47.203-4 Real property excepted from reporting.

Agencies having transferable excess real property and related personal property in the categories excepted from reporting by §101-47.202-4 shall,

before disposal, satisfy themselves in a manner consistent with the provisions of this section that such property is not needed by other Government agencies.

§ 101-47.203-5 Screening of excess real property.

Excess real property and related personal property reported by executive agencies shall, unless such screening is waived, be screened by GSA for utilization by Federal real property holding agencies (listed in §101-47.4907), which may reasonably be expected to have use for the property as follows:

(a) Notices of availability will be submitted to each such agency which shall, within 30 calendar days from the date of notice, advise GSA if there is a firm requirement or a tentative requirement for the property. Agencies having tentative or firm requirements for surplus Federal real property for replacement housing for displaced persons, as authorized by section 218 of the Uniform Relocation Assistance and Real Property Acquisition Policies Act of 1970 (84 Stat. 1902), shall review these notices for the additional purpose of identifying properties for which they may have such a requirement. When such a requirement exists, the agency shall so advise the appropriate GSA regional office.

(1) In the event a tentative requirement exists, the agency shall, within an additional 30 calendar days, advise GSA if there is a firm requirement.

(2) Within 60 calendar days after advice to GSA that a firm requirement exists, the agency shall furnish GSA a request for transfer of the property pursuant to §101-47.203-7.

(b) Notices of availability for information of the Secretary of Health and Human Services and the Secretary of Education in connection with the exercise of the authority vested under the provisions of section 203(k)(1) of the Act; the Secretary of the Interior in connection with provisions in 16 U.S.C. 667b through d, the exercise of the authority vested under the provisions of section 203(k)(2) of the Act, or a determination under the provisions of section 203(k)(3) of the Act; and the Secretary of Housing and Urban Development in connection with the exercise of

the authority vested under the provisions of section 203(k)(6) of the Act will be sent to the offices designated by those officials to serve the areas in which the properties are located. Similar notices of availability for information of the Attorney General and the Director of the Federal Emergency Management Agency in connection with a possible determination under the provisions of section 203(p)(1) of the Act, and for information of the Secretary of Transportation in connection with the exercise of the authority vested under the provisions of section 203(q) of the Act, will be respectively sent to the Office of Justice Programs, Department of Justice; the Federal Emergency Management Agency; and the Maritime Administration, Department of Transportation.

(c) The Departments of Health and Human Services, Education, Interior, Housing and Urban Development, Justice, and Transportation, and the Federal Emergency Management Agency shall not attempt to interest a local applicant in a property until it is determined surplus, except with the prior consent of GSA on a case-by-case basis or as otherwise agreed upon. When such consent is obtained, the local applicant shall be informed that consideration of the application is conditional upon the property being determined surplus to Federal requirements and made available for the purposes of the application. However, these Federal agencies are encouraged to advise the appropriate GSA regional office of those excess properties which are suitable for their programs.

(d) Concurrently with the 30-day Federal agency use screening period, those Federal agencies that sponsor public benefit disposals at less than fair market value as permitted by the statutory authorities in §101-47.4905 may provide the disposal agency with a recommendation, together with a brief supporting rationale, as illustrated in §101-47.4909, that the highest and best use of the property is for a specific public benefit purpose. The recommendation may be made by the agency head, or designee, and will be considered by the disposal agency in its final highest and best use analysis and determination. After a determination of surplus

has been made, if the disposal agency agrees with a sponsoring Federal agency that the highest and best use of a particular property is for a specific public benefit purpose, local public bodies will be notified that the property is available for that use.

[29 FR 16126, Dec. 3, 1964, as amended at 36 FR 11438, June 12, 1971; 47 FR 37175, Aug. 25, 1982; 49 FR 37091, Sept. 21, 1984; 60 FR 35706, July 11, 1995; 64 FR 5615, Feb. 4, 1999]

§ 101-47.203-6 Designation as personal property.

(a) Prefabricated movable structures such as Butler-type storage warehouses, quonset huts, and housetrailer (with or without undercarriages) reported to GSA with the land on which they are located may, in the discretion of GSA, be designated for disposition as personal property for off-site use.

(b) Related personal property may, in the discretion of the disposal agency, be designated for disposition as personal property. Consideration of such designation shall be given particularly to items having possible historic or artistic value to ensure that Federal agencies, including the Smithsonian Institution (see § 101-43.302), are afforded the opportunity of obtaining them through personal property channels for off-site use for preservation and display. Fixtures such as murals and fixed sculpture which have exceptional historical or artistic value may be designated for disposition by severance for off-site use. In making such designations, consideration shall be given to such factors as whether the severance can be accomplished without seriously affecting the value of the realty and whether a ready disposition can be made of the severed fixtures.

(c) When a structure is to be demolished, any fixtures or related personal property therein may, at the discretion of the disposal agency, be designated for disposition as personal property where a ready disposition can be made of these items through such action. As indicated in paragraph (b) of this section, particular consideration should be given to designating items of possible historical or artistic value as personal property in such instances.

[34 FR 8166, May 24, 1969]

§ 101-47.203-7 Transfers.

(a) The agency requesting transfer of excess real property and related personal property reported to GSA shall prepare and submit to the proper GSA regional office GSA Form 1334, Request for Transfer of Excess Real and Related Personal Property (§ 101-47.4904). Instructions for the preparation of GSA Form 1334 are set forth in § 101-47.4904-1.

(b) Upon determination by GSA that a transfer of the property requested is in the best interest of the Government and that the requesting agency is the appropriate agency to hold the property, the transfer may be made among Federal agencies, to mixed-ownership Government corporations, and to the municipal government of the District of Columbia.

(c) [Reserved]

(d) Transfers of property to executive agencies shall be made when the proposed land use is consistent with the policy of the Administrator of General Services as prescribed in § 101-47.201-1 and the policy guidelines prescribed in § 101-47.201-2. In determining whether a proposed transfer should be approved under the policy guidelines, GSA and OMB may consult informally to obtain all available data concerning actual program needs for the property.

(e) GSA will execute or authorize all approved transfers to the requesting agency of property reported to GSA. Agencies may transfer without reference to GSA excess real property which is not reported to GSA under the provisions of § 101-47.202-4(b) (1), (2), and (4). However, such transfers shall be made in accordance with the principles set forth in this section.

(f) Pursuant to an agreement between the Director, Office of Management and Budget, and the Administrator of General Services, reimbursement for transfers of excess real property is prescribed as follows:

(1) Where the transferor agency has requested the net proceeds of the transfer pursuant to section 204 (c) of the Act, or where either the transferor or transferee agency (or organizational unit affected) is subject to the Government Corporation Control Act (31 U.S.C. 841) or is a mixed-ownership

Federal Property Management Regulations

§ 101-47.203-8

Government corporation, or the municipal government of the District of Columbia, reimbursement for the transfer shall be in an amount equal to the estimated fair market value of the property requested as determined by the Administrator: *Provided*, That where the transferor agency is a wholly owned Government corporation, the reimbursement shall be either in an amount equal to the estimated fair market value of the property requested, or the corporation's book value thereof, as may be agreed upon by GSA and the corporation.

(2) Reimbursement for all other transfers of excess real property shall be:

(i) In an amount equal to 100 percent of the estimated fair market value of the property requested, as determined by the Administrator, or if the transfer is for the purpose of upgrading facilities (i.e., for the purpose of replacing other property of the transferee agency which because of the location, nature, or condition thereof, is less efficient for use), the reimbursement shall be in an amount equal to the difference between the estimated fair market value of the property to be replaced and the estimated fair market value of the property requested, as determined by the Administrator.

(ii) Without reimbursement when the transfer is to be made under either of the following conditions:

(A) Congress has specifically authorized the transfer without reimbursement, or

(B) The Administrator with the approval of the Director, Office of Management and Budget, has approved a request for an exception from the 100 percent reimbursement requirement.

(1) A request for exception from the 100 percent reimbursement requirement shall be endorsed by the head of the executive department or agency requesting the exception.

(2) A request for exception from the 100 percent reimbursement requirement will be submitted to GSA for referral to the Director, Office of Management and Budget, and shall include an explanation of how granting the exception would further essential agency program objectives and at the same time be consistent with Executive

Order 12348, dated February 25, 1982. The unavailability of funds alone is not sufficient to justify an exception. The above required data and documentation shall be attached to GSA Form 1334 by the transferee agency on submission of that form to GSA.

(3) If the Administrator with the approval of the Director, Office of Management and Budget, approves the request for an exception, the Administrator may then complete the transfer. A copy of the Office of Management and Budget approval will be sent to the Property Review Board.

(4) The agency requesting the exception will assume responsibility for protection and maintenance costs where the disposal of the property is deferred for more than 30 days because of the consideration of the request for an exception to the 100 percent reimbursement requirement.

(g) Excess property may be transferred to the Senate, the House of Representatives, and the Architect of the Capitol and any activities under his direction, pursuant to the provisions of section 602(e) of the Act. The amount of reimbursement for such transfer shall be the same as would be required for a transfer of excess property to an executive agency under similar circumstances.

(h) The transferor agency shall provide to the transferee agency all information held by the transferor concerning hazardous substance activity as outlined in § 101-47.202-2.

[29 FR 16126, Dec. 3, 1964, as amended at 37 FR 5029, Mar. 9, 1972; 40 FR 12078, Mar. 17, 1975; 42 FR 40698, Aug. 11, 1977; 47 FR 56499, Dec. 17, 1982; 49 FR 29222, July 19, 1984; 56 FR 15048, Apr. 15, 1991]

§ 101-47.203-8 Temporary utilization.

(a) Whenever GSA determines that the temporary assignment or reassignment to a Federal agency of any space in excess real property for office, storage, or related facilities would be more advantageous than the permanent transfer of the property to a Federal agency, it will execute or authorize such assignment or reassignment for such period of time as it shall determine. The agency to which the space is made available shall make appropriate reimbursement for the expense of

maintaining such space in the absence of appropriation available to GSA therefor.

(b) GSA may approve the temporary assignment or reassignment to a Federal agency of excess real property other than space for office, storage, or related facilities whenever such action would be in the best interest of the Government. In such cases, the agency to which the property is made available may be required to pay a rental or users charge based upon the fair value of such property, as determined by GSA. Where such property will be required by the agency for a period of more than 1 year, it may be transferred on a conditional basis, with an understanding that the property will be reported excess at a time agreed upon when the transfer is arranged (see § 101-47.201-2(d)(7)).

§ 101-47.203-9 Non-Federal interim use of property.

The holding agency may, with the approval of GSA, grant rights for non-Federal interim use of excess property reported to GSA, or portions thereof, when it is determined that such interim use is not required for the needs of any Federal agency.

§ 101-47.203-10 Withdrawals.

Subject to the approval of GSA, and to such conditions as GSA considers appropriate, reports of excess real property may be withdrawn in whole or in part by the reporting agency at any time prior to transfer to another Federal agency or prior to the execution of a legally binding agreement for disposal as surplus property. Requests for withdrawals shall be addressed to the GSA regional office where the report of excess real property was filed.

[35 FR 17256, Nov. 6, 1970]

§ 101-47.204 Determination of surplus.

§ 101-47.204-1 Reported property.

Any real property and related personal property reported excess under this subpart 101-47.2 which has been screened for needs of Federal agencies or waived from such screening by GSA, and not been designated by GSA for utilization by a Federal agency, shall

be subject to determination as surplus property by GSA.

(a) The holding agency, the Secretary of Health and Human Services, the Secretary of Education, the Secretary of the Interior, the Secretary of Housing and Urban Development, the Attorney General, the Director of the Federal Emergency Management Agency, and the Secretary of Transportation will be notified of the date upon which determination as surplus becomes effective. Any Federal agency that has identified a property as being required for replacement housing for displaced persons under section 218 of the Uniform Relocation Assistance and Real Property Acquisition Policies Act of 1970 will also be notified of the date upon which determination as surplus becomes effective. The Secretary of the Department of Energy will be notified when real property is determined surplus and advised of any known interest in the property for its use or development for energy facilities. Appropriate steps will be taken to ensure that energy site needs are considered along with other competing needs in the disposal of surplus real property, since such property may become available for use under sections 203(e)(3) (G) and (H) of the Act.

(b) The notices to the Secretary of Health and Human Services, the Secretary of Education, the Secretary of the Interior, the Secretary of Housing and Urban Development, and the Secretary of Energy will be sent to the offices designated by them to serve the area in which the property is located. The notices to the Attorney General will be sent to the Office of Justice Programs, Department of Justice. The notices to the Director of the Federal Emergency Management Agency will be sent to the Federal Emergency Management Agency. The notices to the Secretary of Transportation will be sent to the Federal Aviation Administration, the Federal Highway Administration, and the Maritime Administration. The notices to the Federal agencies having a requirement pursuant to section 218 of the Uniform Relocation Assistance and Real Property Acquisition Policies Act of 1970 will be sent to the office making the request unless another office is designated.

Federal Property Management Regulations

§ 101-47.301-2

(c) With regard to surplus property which GSA predetermines will not be available for disposal under any of the statutes cited in §101-47.4905, or whenever the holding agency has requested reimbursement of the net proceeds of disposition pursuant to section 204(c) of the Act, the notice to the affected Federal agencies will contain advice of such determination or request for reimbursement. The affected Federal agencies shall not screen for potential applicants for such property.

[29 FR 16126, Dec. 3, 1964, as amended at 36 FR 8041, Apr. 29, 1971; 47 FR 37175, Aug. 25, 1982; 60 FR 35706, July 11, 1995; 64 FR 5616, Feb. 4, 1999]

§ 101-47.204-2 Property excepted from reporting.

Any property not reported to GSA due to §101-47.202-4, and not designated by the holding agency for utilization by other agencies pursuant to the provisions of this subpart 101-47.2, shall be subject to determination as surplus by the holding agency.

Subpart 101-47.3—Surplus Real Property Disposal

§ 101-47.300 Scope of subpart.

This subpart prescribes the policies and methods governing the disposal of surplus real property and related personal property within the States of the Union, the District of Columbia, the Commonwealth of Puerto Rico, American Samoa, Guam, the Trust Territory of the Pacific Islands, and the Virgin Islands. This subpart does not apply to the abandonment, destruction, or donation to public bodies, under section 202(h) of the Act (covered by subpart 101-47.5).

[47 FR 4522, Feb. 1, 1982]

§ 101-47.301 General provisions of subpart.

§ 101-47.301-1 Policy.

It is the policy of the Administrator of General Services:

(a) That surplus real property shall be disposed of in the most economical manner consistent with the best interests of the Government.

(b) That surplus real property shall ordinarily be disposed of for cash consistent with the best interests of the Government.

(c) That surplus real property shall be disposed of by exchange for privately owned property only for property management considerations such as boundary realignment or provision of access or in those situations in which the acquisition is authorized by law, the requesting Federal agency has received approval from the Office of Management and Budget and clearance from its congressional oversight committees to acquire by exchange, and the transaction offers substantial economic or unique program advantages not otherwise obtainable by any other method of acquisition.

[29 FR 16126, Dec. 3, 1964, as amended at 42 FR 47205, Sept. 20, 1977; 42 FR 56123, Oct. 21, 1977]

§ 101-47.301-2 Applicability of anti-trust laws.

(a) In any case in which there is contemplated a disposal to any private interest of real and related personal property which has an estimated fair market value of \$3,000,000 or more, or of patents, processes, techniques, or inventions, irrespective of cost, the disposal agency shall transmit promptly to the Attorney General notice of any such proposed disposal and the probable terms or conditions thereof, as required by section 207 of the Act, for his advice as to whether the proposed disposal would tend to create or maintain a situation inconsistent with antitrust laws, and no such real property shall be disposed of until such advice has been received. If such notice is given by any executive agency other than GSA, a copy of the notice shall be transmitted simultaneously to the office of GSA for the region in which the property is located.

(b) Upon request of the Attorney General, GSA or any other executive agency shall furnish or cause to be furnished such information as it may possess which the Attorney General determines to be appropriate or necessary to enable him to give the requested advice

§ 101-47.301-3

or to determine whether any other disposition or proposed disposition of surplus real property violates or would violate any of the antitrust laws.

[29 FR 16126, Dec. 3, 1964, as amended at 54 FR 12198, Mar. 24, 1989]

§ 101-47.301-3 Disposals under other laws.

Pursuant to section 602(c) of the act, disposals of real property shall not be made under other laws but shall be made only in strict accordance with the provisions of this subpart 101-47.3 unless the Administrator of General Services, upon written application by the disposal agency, shall determine in each case that the provisions of any such other law, pursuant to which disposal is proposed to be made, are not inconsistent with the authority conferred by this Act. The provisions of this section shall not apply to disposals of real property authorized to be made by section 602(d) of the act or by any special statute which directs or requires an executive agency named therein to transfer or convey specifically described real property in accordance with the provisions of such statute.

§ 101-47.301-4 Credit disposals and leases.

Where credit is extended in connection with any disposal of surplus property, the disposal agency shall offer credit pursuant to the provisions of § 101-47.304-4. The disposal agency shall administer and manage the credit lease, or permit and any security therefor and may enforce, adjust, or settle any right of the Government with respect thereto in such manner and upon such terms as that agency considers to be in the best interests of the Government.

[42 FR 47205, Sept. 20, 1977]

§ 101-47.302 Designation of disposal agencies.

§ 101-47.302-1 General.

In accordance with applicable provisions of this subpart 101-47.3, surplus real property shall be disposed of or assigned to the appropriate Federal de-

41 CFR Ch. 101 (7-1-01 Edition)

partment for disposal for public use purposes by the disposal agency.

[36 FR 8042, Apr. 29, 1971]

§ 101-47.302-2 Holding agency.

(a) The holding agency is hereby designated as disposal agency for:

(1) Leases, permits, licenses, easements, and similar real estate interests held by the Government in non-Government-owned property (including Government-owned improvements located on the premises), except when it is determined by either the holding agency or GSA that the Government's interest will be best served by the disposal of such real estate interests together with other property owned or controlled by the Government, that has been or is being reported to GSA as excess; and

(2) Fixtures, structures, and improvements of any kind to be disposed of without the underlying land with the exception of Government-owned machinery and equipment, which are fixtures being used by a contractor-operator, where such machinery and equipment will be sold to the contractor-operator.

(3) Standing timber and embedded gravel, sand, stone and underground water to be disposed of without the underlying land.

(b) GSA may act as the disposal agency for the type of property described in paragraphs (a) (1) and (2) of this section, whenever requested by the holding agency to perform the disposal functions. Where GSA acts as the disposal agency for the disposal of leases and similar real estate interests as described in paragraph (a)(1) of this section, the holding agency nevertheless shall continue to be responsible for the payment of the rental until the lease is terminated and for the payment of any restoration or other direct costs incurred by the Government as an incident to the termination. Likewise, where GSA acts as disposal agency for the disposal of fixtures, structures, and improvements as described in paragraph (a)(2) of this section, the holding agency nevertheless shall continue to

Federal Property Management Regulations

§ 101-47.303-2

be responsible for payment of any demolition and removal costs not offset by the sale of the property.

[29 FR 16126, Dec. 3, 1964, as amended at 31 FR 2658, Feb. 11, 1966; 31 FR 16780, Dec. 31, 1966; 33 FR 8737, June 14, 1968; 48 FR 12526, Mar. 25, 1983; 50 FR 28403, July 12, 1985]

§ 101-47.302-3 General Services Administration.

GSA is the disposal agency for all real property and related personal property not covered by the above designations or by disposal authority delegated by the Administrator of General Services in specific instances.

§ 101-47.303 Responsibility of disposal agency.

§ 101-47.303-1 Classification.

Each surplus property, or, if the property is subdivided, each unit of property shall be classified by the disposal agency to determine the methods and conditions applicable to the disposal of the property. Classification shall be according to the estimated highest and best use for the property. The property may be reclassified from time to time by the disposal agency or by GSA whenever such action is deemed appropriate.

§ 101-47.303-2 Disposals to public agencies.

The disposal agency shall comply with the provisions of Executive Order 12372 and 41 CFR subpart 101-6.21, which enables a State to establish the single point of contact process or other appropriate procedures to review and comment on the compatibility of a proposed disposal with State, regional and local development plans and programs. When a single point of contact transmits a State review process recommendation, the Federal agency receiving the recommendation must either accept the recommendation; reach a mutually agreeable solution with the party(s) preparing the recommendation; or provide the single point of contact with a written explanation for not accepting the recommendation or reaching a mutually agreeable solution. If there is nonaccommodation, the agency is generally required to wait 10 calendar days after receipt, by

the single point of contact, of an explanation before taking final action. The single point of contact is presumed to have received written notification 5 calendar days after the date of mailing of such notification. The 10-day waiting period may be waived if the agency determines that because of unusual circumstances this delay is not feasible.

(a) Whenever property is determined to be surplus, the disposal agency shall, on the basis of the information given in §101-47.4905, list the public agencies eligible under the provisions of the statutes referred to above to procure the property or portions thereof, except that such listing need not be made with respect to:

(1) Any such property when the determination of the property as surplus is conditioned upon disposal limitations which would be inconsistent with disposal under the statutes authorizing disposal to eligible public agencies; or

(2) Any such property having an estimated fair market value of less than \$1,000 except where the disposal agency has any reason to believe that an eligible public agency may be interested in the property.

(b) Before public advertising, negotiation, or other disposal action, the disposal agency shall give notice to eligible public agencies that the property has been determined surplus. Surplus real property may be procured by public agencies under the statutes cited in §101-47.4905. A notice to public agencies of surplus determination shall be prepared following the sample shown in §101-47.4906. This notice shall be transmitted by a letter prepared following the sample shown in §101-47.4906-1. A copy of this notice shall also be sent simultaneously to the State single point of contact, under a covering letter prepared following the sample shown in §101-47.4906-2. The point of contact shall be advised that no final disposal action will be taken for 60 calendar days from the date of notification to allow time for the point of contact to provide any desired comments. The disposal agency will wait the full 60 calendar days, even if the comments are received early, to allow time for the point of contact to send additional or revised comments.

(1) Notice for property located in a State shall be given to the Governor of the State, to the county clerk or other appropriate officials of the county in which the property is located, to the mayor or other appropriate officials of the city or town in which the property is located, to the head of any other local governmental body known to be interested in and eligible to acquire the property, and to the point of contact established by the State or under other appropriate procedures established by the State.

(2) Notice for property located in the District of Columbia shall be given to the Mayor of the District of Columbia and to the point of contact established by the District of Columbia or under other appropriate procedures established by the District of Columbia.

(3) Notice for property located in the Virgin Islands shall be given to the Governor of the Virgin Islands and to the point of contact established by the Virgin Islands or under other appropriate procedures established by the Virgin Islands.

(4) Notice for property located in the Commonwealth of Puerto Rico shall be given to the Governor of the Commonwealth of Puerto Rico and to the point of contact established by the Commonwealth of Puerto Rico or under other appropriate procedures established by the Commonwealth of Puerto Rico.

(c) The notice prepared pursuant to § 101-47.303-2(b) shall also be posted in the post office which serves the area in which the property is located and in other prominent places such as the State capitol building, county building, courthouse, town hall, or city hall. The notice to be posted in the post office shall be mailed to the postmaster with a request that it be posted. Arrangements for the posting of the notice in other prominent places shall be as provided for in the transmittal letters (see § 101-47.4906-1) to eligible public agencies.

(d) A copy of the notice described in paragraph (b) of this section shall be furnished to the appropriate regional or field offices of (1) the National Park Service (NPS) and the Fish and Wildlife Service of the Department of the Interior and (2) the Federal Aviation Administration, the Federal Highway

Administration, and the Maritime Administration of the Department of Transportation concerned with the disposal of property to public agencies under the statutes named in the notice.

(e) In the case of property which may be made available for assignment to the Secretary of Health and Human Services (HHS), the Secretary of Education (ED), the Secretary of the Interior (DOI), or the Secretary of Housing and Urban Development (HUD) for disposal under sections 203(k)(1), (2), or (6) of the Act:

(1) The disposal agency shall inform the appropriate offices of HHS, ED, NPS, or HUD 3 workdays in advance of the date the notice will be given to public agencies, to permit similar notice to be given simultaneously by HHS, ED, NPS, or HUD to additional interested public bodies and/or non-profit institutions.

(2) The disposal agency shall furnish the Federal agencies with a copy of the postdated transmittal letter addressed to each public agency, copies (not to exceed 25) of the postdated notice, and a copy of the holding agency's Report of Excess Real Property (Standard Form 118, with accompanying schedules).

(3) As of the date of the transmittal letter and notice to public agencies, the affected Federal agencies may proceed with their screening functions for any potential applicants and thereafter may make their determinations of need and receive applications.

(f) If the disposal agency is not informed within the 20- or 30-calendar day period provided in the notice of the desire of a public agency to acquire the property under the provisions of the statutes listed in § 101-47.4905, or is not notified by ED or HHS of a potential educational or public health use, or is not notified by the DOI of a potential park or recreation, historic monument, or wildlife conservation use, or is not notified by the HUD of a potential self-help housing or housing assistance requirement, or is not notified by the Department of Justice of a potential correctional facilities or law enforcement use, or is not notified by the Federal Emergency Management Agency of a

Federal Property Management Regulations

§ 101-47.303-2a

potential emergency management response use; or is not notified by the Department of Transportation of a potential port facility or public airport use, it shall be assumed that no public agency or otherwise eligible organization desires to procure the property. (The requirements of this §101-47.303-2(f) shall not apply to the procedures for making Federal surplus real property available to assist the homeless in accordance with section 501 of the Stewart B. McKinney Homeless Assistance Act, as amended (42 U.S.C. 11411).)

(g) The disposal agency shall promptly review each response of a public agency to the notice given pursuant to paragraph (b) of this section. The disposal agency shall determine what constitutes a reasonable period of time to allow the public agency to develop and submit a formal application for the property or its comments as to the compatibility of the disposal with its development plans and programs. When making such determination, the disposal agency shall give consideration to the potential suitability of the property for the use proposed, the length of time the public agency has stated it will require for its action, the protection and maintenance costs to the Government during such length of time, and any other relevant facts and circumstances. The disposal agency shall coordinate such review and determination with the proper office of any interested Federal agencies listed below:

- (1) National Park Service, Department of the Interior;
- (2) Department of Health and Human Services;
- (3) Department of Education;
- (4) Department of Housing and Urban Development;
- (5) Federal Aviation Administration, Department of Transportation;
- (6) Fish and Wildlife Service, Department of the Interior;
- (7) Federal Highway Administration, Department of Transportation;
- (8) Office of Justice Programs, Department of Justice;
- (9) Federal Emergency Management Agency; and
- (10) Maritime Administration, Department of Transportation.

(h) When the disposal agency has made a determination as to what con-

stitutes a reasonable period of time to develop and submit a formal application, the public agency shall be so notified. The public agency shall be advised of the information required in connection with an application to procure the property.

(i) Upon receipt of the formal application for the property, the disposal agency shall consider and act upon it in accordance with the provisions of the statute and applicable regulations. If comments are received indicating that the disposal is incompatible with State, regional, or local development plans and programs, the disposal agency shall attempt to resolve the differences consistent with its statutory responsibilities in the disposal of surplus property.

[29 FR 16126, Dec. 3, 1964, as amended at 34 FR 11209, July 3, 1969; 35 FR 8486, June 2, 1970; 36 FR 9776, May 28, 1971; 40 FR 22256, May 22, 1975; 52 FR 9829, Mar. 27, 1987; 60 FR 35707, July 11, 1995; 64 FR 5616, Feb. 4, 1999]

§ 101-47.303-2a Notice for zoning purposes.

(a) Where the surplus land is located in an urban area as defined in section 806 of the Act, that copy of the notice to public agencies required under §101-47.303-2(b) which is sent to the head of the local governmental unit having jurisdiction over zoning and land use regulation in the area shall be accompanied by a copy of section 803 of the Act (see §101-47.4906a) and the transmittal letter in such instances shall include an additional paragraph requesting information concerning zoning as set forth in §101-47.4906b.

(b) Information which is furnished by the unit of general local government pursuant to the action taken in paragraph (a) of this section shall be included in Invitations for Bid in advertised sales. In negotiated sales, this information shall be presented to prospective purchasers during the course of the negotiations and shall be included in the sales agreements. In either instance, this information shall be followed by a written statement, substantially as follows:

The above information was obtained from _____ and is furnished pursuant to section 803 of the Federal Property and Administrative Services Act of 1949, as

§ 101-47.303-3

amended. The Government does not guarantee that the information is necessarily accurate or will remain unchanged. Any inaccuracies or changes in the above information shall not be cause for adjustment or rescission of any contract resulting from this Invitation for Bid or Sales Agreement.

(c) If no response to a request for such zoning information is received, the property may be offered for sale without furnishing such information to prospective purchasers. If the unit of general local government notifies the disposal agency of its desire to zone the property, it shall be afforded a 30-calendar-day period (in addition to the 20-calendar days afforded in the notice of surplus determination) to issue such zoning regulations. If the zoning cannot be accomplished within this time frame, the sale may proceed but the prospective purchasers shall be advised of the pending zoning of the property.

[34 FR 11209, July 3, 1969]

§ 101-47.303-3 Studies.

The disposal agency shall compile from the title documents and related papers appropriate information, for use in disposal actions, regarding all real property and related personal property available for disposal.

§ 101-47.303-4 Appraisal.

(a) Except as otherwise provided in this subpart 101-47.3, the disposal agency shall in all cases obtain, as appropriate, an appraisal of either the fair market value or the fair annual rental value of property available for disposal.

(b) *No appraisal need be obtained.* (1) When the property is to be disposed of without monetary consideration, or at a fixed price, or

(2) When the estimated fair market value of property to be offered on a competitive sale basis does not exceed \$50,000;

Provided, however, That the exception in paragraph (b)(1) of this section shall not apply to disposals that take any public benefit purpose into consideration in fixing the sale value of the property.

(c) The disposal agency shall have the property appraised by experienced and qualified persons familiar with the types of property to be appraised by

41 CFR Ch. 101 (7-1-01 Edition)

them. If the property is included in or eligible for inclusion on the National Register of Historic Places, the appraisal should consider the effect of historic covenants on fair market value.

(d) *Appraisal confidentiality.* Appraisals, appraisal reports, appraisal analyses, and other pre-decisional documents obtained in accordance with this subpart are confidential and for the use of authorized personnel of Government agencies having a need for such information. Further, such information shall not be divulged prior to the delivery and acceptance of the deed. Any person engaged to collect or evaluate information pursuant to this paragraph shall certify that there is no interest, direct or indirect, in the property which would conflict in any manner with the preparation and submission of an impartial appraisal report.

[29 FR 16126, Dec. 3, 1964, as amended at 55 FR 41189, Oct. 10, 1990; 64 FR 31732, June 14, 1999]

§ 101-47.304 Advertised and negotiated disposals.

§ 101-47.304-1 Publicity.

(a) The disposal agency shall widely publicize all surplus real property and related personal property which becomes available for disposal hereunder, giving information adequate to inform interested persons of the general nature of the property and its possible uses, as well as any reservations, restrictions, and conditions imposed upon its disposal.

(b) A condensed statement of proposed sales of surplus real property by advertising for competitive bids, except where the estimated fair market value of the property is less than \$2,500, shall be prepared and submitted, for inclusion in the U.S. Department of Commerce publication "Commerce Business Daily," to: U.S. Department of Commerce (S-Synopsis), room 1300, 433 West Van Buren Street, Chicago, Illinois 60604.

§ 101-47.304-2 Soliciting cooperation of local groups.

The disposal agency may consult with local groups and organizations and solicit their cooperation in giving

Federal Property Management Regulations

§ 101-47.304-4

wide publicity to the proposed disposal of the property.

§ 101-47.304-3 Information to interested persons.

The disposal agency shall, upon request, supply to bona fide potential purchasers and lessees adequate preliminary information, and, with the cooperation of the holding agency where necessary, shall render such assistance to such persons as may enable them, insofar as feasible, to obtain adequate information regarding the property. The disposal agency shall establish procedures so that all persons showing due diligence are given full and complete opportunity to make an offer.

§ 101-47.304-4 Invitation for offers.

In all advertised and negotiated disposals, the disposal agency shall prepare and furnish to all prospective purchasers or lessees written invitations to make an offer, which shall contain or incorporate by reference all the terms and conditions under which the property is offered for disposal, including all provisions required by statute to be made a part of the offer. The invitation shall further specify the form of the disposal instrument, which specifications shall be in accordance with the appropriate provisions of §§ 101-47.307-1 and 101-47.307-2.

(a) When the disposal agency has determined that the sale of specific property on credit terms is necessary to avoid retarding the salability of the property and the price obtainable, the invitation shall provide for submission of offers on the following terms:

(1) Offers to purchase of less than \$2,500 shall be for cash.

(2) When the purchase price is \$2,500 or more but less than \$10,000, a cash downpayment of not less than 25 percent shall be required with the balance due in 8 years or less.

(3) When the purchase price is \$10,000 or more, a cash downpayment of not less than 20 percent shall be required with the balance due in 10 years or less.

(4) The purchaser shall furnish a promissory note secured by the purchase money mortgage or deed of trust on the property, whichever the Government determines to be appropriate.

(5) Payment will be in equal quarterly annual installments of the principal together with interest on the unpaid balance.

(6) Interest on the unpaid balance will be at the General Services Administration's established interest rate.

(b) Where the disposal agency has determined that an offering of the property on credit terms that do not meet the standards set forth in § 101-47.304-4(a) is essential to permit disposal of the property in the best interests of the Government, the invitation may provide for submission of offers on such alternate terms of payment as may be recommended by the disposal agency and approved by the Administrator of General Services on the basis of a detailed written statement justifying the need to deviate from the standard terms. The justification shall be based on the needs of the Federal Government as distinguished from the interests of the purchaser. The sale in those cases where the downpayment is less than 20 percent shall, unless otherwise authorized by the Administrator of General Services, be under a land contract which shall provide, in effect, for conveyance of title to the purchaser by quitclaim deed or other form of conveyance in accordance with the appropriate provisions of §§ 101-47.307-1 and 101-47.307-2 upon payment of one-third of the total purchase price and accrued interest, or earlier if the Government so elects, and execution and delivery of purchaser's note and purchase money mortgage (or bond and deed of trust) satisfactory to the Government, to secure payment of the unpaid balance of the purchase price.

(c) The disposal agency may increase the cash downpayment requirement or shorten the period of amortization whenever circumstances warrant and in the case of sales of farms, may provide for payment of the unpaid balance on equal semiannual or annual installment basis.

(d) Where a sale is to be made on credit, the invitation shall provide that the purchaser agrees by appropriate provisions to be incorporated in the disposal instruments that he will not lease (unless the property was offered without leasing restrictions by the Government) or sell the property, or

§ 101-47.304-5

41 CFR Ch. 101 (7-1-01 Edition)

any part thereof or interest therein, without prior written authorization of the Government.

(1) In appropriate cases, except as provided in §101-47.304-4(d)(2), the invitation shall state that the disposal instrument may include provisions specifically authorizing leasing and/or resale and release of portions of the property as desired by the purchaser, provided that such provisions shall, in the judgment of the Government, be adequate to protect its security for the credit extended to the purchaser.

(2) In the case of timber or mineral lands, or lands containing other saleable products, the invitation shall state that the disposal instrument may specifically provide for granting future partial releases to permit the resale of timber, minerals, and other saleable products, or authorize the leasing of mineral rights, upon payment to the Government of such amounts as may be required by the Government but not less than the proceeds of any sale or lease less such amounts as may be determined by the Government to represent the cost of the sale or lease.

(3) All payments for such authorizations and/or releases shall, at the option of the Government, be applied against the unpaid balance of the indebtedness in inverse order of its maturity, or upon any delinquent installments of principal and interest, or used for payments of any delinquent taxes or insurance premiums.

(e) Where property is offered for disposal under a land contract or lease, the terms and conditions contained in the invitation shall provide that the purchaser or lessee will be required to pay to the proper taxing authorities or to the disposal agency, as may be directed, all taxes, payments in lieu of taxes (in the event of the existence or subsequent enactment of legislation authorizing such payments), assessments or similar charges which may be assessed or imposed on the property, or upon the occupier thereof, or upon the use or operation of the property and to assume all costs of operating obligations.

(f) Whenever property is offered for sale on credit terms or for lease, the terms and conditions contained in the invitation shall provide that the pur-

chaser or lessee shall procure and maintain at his expense during the term credit is extended, or the period of the lease, such insurance in such amounts as may be required by the Government; required insurance shall be in companies acceptable to the Government and shall include such terms and provisions as may be required to provide coverage satisfactory to the Government.

[29 FR 16126, Dec. 3, 1964, as amended at 33 FR 12003, Aug. 23, 1968; 42 FR 47205, Sept. 20, 1977]

§ 101-47.304-5 Inspection.

All persons interested in the acquisition of surplus property available for disposal under this subpart 101-47.3 shall, with the cooperation of the holding agency, where necessary, and with due regard to its program activities, be permitted to make a complete inspection of such property, including any available inventory records, plans, specifications, and engineering reports made in connection therewith, subject to any necessary restrictions in the interest of national security and subject to such rules as may be prescribed by the disposal agency.

(See §§101-47.304-13 and 101-47.403.)

[53 FR 29894, Aug. 9, 1988]

§ 101-47.304-6 Submission of offers.

All offers to purchase or lease shall be in writing, accompanied by any required earnest money deposit, using the form prescribed by the disposal agency and, in addition to the financial terms upon which the offer is predicated, shall set forth the willingness of the offeror to abide by the terms, conditions, reservations, and restrictions upon which the property is offered, and shall contain such other information as the disposal agency may request.

§ 101-47.304-7 Advertised disposals.

(a) All disposals or contracts for disposal of surplus property, except as provided in §§101-47.304-9 and 101-47.304-10, shall be made after publicly advertising for bids.

(1) The advertising for bids shall be made at such time previous to the disposal or contract, through such methods and on such terms and conditions

Federal Property Management Regulations

§ 101-47.304-9

as shall permit that full and free competition which is consistent with the value and nature of the property involved. The advertisement shall designate the place to which the bids are to be delivered or mailed, and shall state the place, date, and time of public opening.

(2) All bids shall be publicly disclosed at the time and place stated in the advertisement.

(3) Award shall be made with reasonable promptness by notice to the responsible bidder whose bid, conforming to the invitation for bids, will be most advantageous to the Government, price and other factors considered: *Provided*, That all bids may be rejected when it is in the public interest to do so.

(b) Disposal and contracts for disposal of surplus property may be made through contract auctioneers when authorized by GSA. The auctioneer retained under contract shall be required to publicly advertise for bids in accordance with the applicable provisions of this § 101-47.304-7.

§ 101-47.304-8 [Reserved]

§ 101-47.304-9 Negotiated disposals.

(a) Disposal agencies shall obtain such competition as is feasible under the circumstances in all negotiations of disposals and contracts for disposal of surplus property. They may dispose of surplus property by negotiation only in the following situations:

(1) When the estimated fair market value of the property involved does not exceed \$15,000;

(2) When bid prices after advertising therefor are not reasonable (either as to all or some part of the property) or have not been independently arrived at in open competition;

(3) When the character or conditions of the property or unusual circumstances make it impractical to advertise publicly for competitive bids and the fair market value of the property and other satisfactory terms of disposal can be obtained by negotiation;

(4) When the disposals will be to States, Commonwealth of Puerto Rico, possessions, political subdivisions thereof, or tax-supported agencies therein, and the estimated fair market

value of the property and other satisfactory terms of disposal are obtained by negotiation; or

(5) When negotiation is otherwise authorized by the Act or other law, such as:

(i) Disposals of power transmission lines for public or cooperative power projects (see § 101-47.308-1).

(ii) Disposals for public airport utilization (see § 101-47.308-2).

(b) Appraisal data required pursuant to the provisions of § 101-47.303-4, when needed for the purpose of conducting negotiations under § 101-47.304-9(a) (3), (4), or (5)(i) shall be obtained under contractual arrangements with experienced and qualified real estate appraisers familiar with the types of property to be appraised by them: *Provided, however*, That in any case where the cost of obtaining such data from a contract appraiser would be out of proportion to the expected recoverable value of the property, or if for any other reason employing a contract appraiser would not be in the best interest of the Government, the head of the disposal agency or his designee should authorize any other method of obtaining an estimate of the fair market value of the property or the fair annual rental he may deem to be proper.

(c) Negotiated sales to public bodies under 40 U.S.C. 484(e)(3)(H) will be considered only when the disposal agency has made a determination that a public benefit will result from the negotiated sale which would not be realized from a competitive sale disposal. The offer to purchase and the conveyance document concerning such negotiated sales shall contain an excess profits covenant. A standard Excess Profits Covenant for Negotiated Sales to Public Bodies is illustrated in § 101-47.4908. The standard covenant is provided as a guide, and appropriate modifications may be made provided that its basic purpose is retained. The disposal agency shall monitor the property involved and inspect records related thereto as necessary to ensure compliance with the terms and conditions of the sale and may take any actions which it deems reasonable and prudent to recover any excess profits realized through the resale of the property.

(d) The annual report of the Administrator under section 212 of the Act shall contain or be accompanied by a listing and description of any negotiated disposals of surplus real property having an estimated fair market value of over \$15,000, other than disposals for which an explanatory statement has been transmitted under §101-47.304-12.

[29 FR 16126, Dec. 3, 1964, as amended at 40 FR 22256, May 22, 1975; 51 FR 23760, July 1, 1986; 54 FR 12198, Mar. 24, 1989]

§ 101-47.304-10 Disposals by brokers.

Disposals and contracts for disposal of surplus property through contract realty brokers, where authorized by GSA, shall be made in the manner followed in similar commercial transactions. Realty brokers retained under contracts shall be required to give wide public notice of availability of the property for disposal.

§ 101-47.304-11 Documenting determinations to negotiate.

The disposal agency shall document the factors leading to and the determination justifying disposal by negotiation of any surplus property under §§101-47.304-9 and 101-47.304-10, and shall retain such documentation in the files of the agency.

§ 101-47.304-12 Explanatory statements.

(a) Subject to the exception stated in §101-47.304-12(b), the disposal agency shall prepare an explanatory statement, as required by section 203(e)(6) of the Act, of the circumstances of each of the following proposed disposals by negotiation:

(1) Any real property that has an estimated fair market value in excess of \$100,000, except that any real property disposed of by lease or exchange shall only be subject to paragraphs (a) (2) through (4) of this section;

(2) Any real property disposed of by lease for a term of 5 years or less; if the estimated fair annual rent is in excess of \$100,000 for any of such years;

(3) Any real property disposed of by lease for a term of more than 5 years, if the total estimated rent over the term of the lease is in excess of \$100,000; or

(4) Any real property or real and related personal property disposed of by exchange, regardless of value, or any property any part of the consideration for which is real property.

(b) No explanatory statement need be prepared for a disposal of property authorized to be disposed of without advertising by any provision of law other than section 203(e) of the Act.

(c) An outline for the preparation of the explanatory statement is shown in §101-47.4911. A copy of the statement shall be preserved in the files of the disposal agency.

(d) Each explanatory statement when prepared shall be submitted to the Administrator of General Services for review and transmittal by the Administrator of General Services by letters to the Committees on Government Operations and any other appropriate committees of the Senate and House of Representatives. The submission to the Administrator of General Services shall include such supporting data as may be relevant and necessary for evaluating the proposed action.

(e) Copies of the Administrator of General Services' transmittal letters to the committees of the Congress, §101-47.304-12(d), will be furnished to the disposal agency.

(f) In the absence of adverse comment by an appropriate committee or subcommittee of the Congress on the proposed negotiated disposal, the disposal agency may consummate the sale on or after 35 days from the date of the Administrator of General Services letters transmitting the explanatory statement to the committees.

[29 FR 16126, Dec. 3, 1964, as amended at 41 FR 22354, June 3, 1976; 54 FR 12198, Mar. 24, 1989]

§ 101-47.304-13 Provisions relating to asbestos.

Where the existence of asbestos on the property has been brought to the attention of the disposal agency by the Standard Form 118 information provided in accordance with §101-47.202-2)(b)(9), the disposal agency shall incorporate such information (less any cost or time estimates to remove the asbestos-containing materials) in any Invitation for Bids/Offer to Purchase and include the following:

Federal Property Management Regulations

§ 101-47.304-14

NOTICE OF THE PRESENCE OF ASBESTOS— WARNING!

(a) The Purchaser is warned that the property offered for sale contains asbestos-containing materials. Unprotected or unregulated exposures to asbestos in product manufacturing, shipyard, and building construction workplaces have been associated with asbestos-related diseases. Both the Occupational Safety and Health Administration (OSHA) and the Environmental Protection Agency (EPA) regulate asbestos because of the potential hazards associated with exposure to airborne asbestos fibers. Both OSHA and EPA have determined that such exposure increases the risk of asbestos-related diseases, which include certain cancers and which can result in disability or death.

(b) Bidders (Offerors) are invited, urged and cautioned to inspect the property to be sold prior to submitting a bid (offer). More particularly, bidders (offerors) are invited, urged and cautioned to inspect the property as to its asbestos content and condition and any hazardous or environmental conditions relating thereto. The disposal agency will assist bidders (offerors) in obtaining any authorization(s) which may be required in order to carry out any such inspection(s). Bidders (Offerors) shall be deemed to have relied solely on their own judgment in assessing the overall condition of all or any portion of the property including, without limitation, any asbestos hazards or concerns.

(c) No warranties either express or implied are given with regard to the condition of the property including, without limitation, whether the property does or does not contain asbestos or is or is not safe for a particular purpose. The failure of any bidder (offeror) to inspect, or to be fully informed as to the condition of all or any portion of the property offered, will not constitute grounds for any claim or demand for adjustment or withdrawal of a bid or offer after its opening or tender.

(d) The description of the property set forth in the Invitation for Bids (Offer to Purchase) and any other information provided therein with respect to said property is based on the best information available to the disposal agency and is believed to be correct, but an error or omission, including but not limited to the omission of any information available to the agency having custody over the property and/or any other Federal agency, shall not constitute grounds or reason for nonperformance of the contract of sale, or any claim by the Purchaser against the Government including, without limitation, any claim for allowance, refund, or deduction from the purchase price.

(e) The Government assumes no liability for damages for personal injury, illness, disability or death, to the Purchaser, or to the

Purchaser's successors, assigns, employees, invitees, or any other person subject to Purchaser's control or direction, or to any other person, including members of the general public, arising from or incident to the purchase, transportation, removal, handling, use, disposition, or other activity causing or leading to contact of any kind whatsoever with asbestos on the property which is the subject of this sale, whether the Purchaser, its successors or assigns has or have properly warned or failed properly to warn the individual(s) injured.

(f) The Purchaser further agrees that in its use and occupancy of the property it will comply with all Federal, state, and local laws relating to asbestos.

[53 FR 29894, Aug. 9, 1988]

§ 101-47.304-14 Provisions relating to hazardous substance activity.

(a) Where the existence of hazardous substance activity has been brought to the attention of the disposal agency by the Standard Form 118 information provided in accordance with §101-47.202-2(b)(10), the disposal agency shall incorporate such information into any Invitation for Bids/Offer to Purchase and include the following statements:

Notice regarding hazardous substance activity:

The information contained in this notice is required under the authority of regulations promulgated under section 120(h) of the Comprehensive Environmental Response, Compensation and Liability Act (CERCLA or "Superfund"), 42 U.S.C. section 9620(h).

The (holding agency) advises that (provide information on the type and quantity of hazardous substances; the time at which storage, release, or disposal took place; and a description of the remedial action taken).

All remedial action necessary to protect human health and the environment with respect to the hazardous substance activity during the time the property was owned by the United States has been taken. Any additional remedial action found to be necessary shall be conducted by the United States.

(b) In the case where the purchaser is a potentially responsible party (PRP) with respect to the hazardous substance activity, the above statements must be modified as appropriate to properly represent the liability of the PRP for any remedial action.

[56 FR 15048, Apr. 15, 1991]

§ 101-47.305

41 CFR Ch. 101 (7-1-01 Edition)

§ 101-47.305 Acceptance of offers.

disposal under other applicable provisions of this subpart 101-47.3.

§ 101-47.305-1 General.

[29 FR 16126, Dec. 3, 1964, as amended at 50 FR 25223, June 18, 1985]

(a) When the head of the disposal agency or his designee determines that bid prices (either as to all or some part of the property) received after advertising therefor or received in response to the action authorized in paragraph (b) of this §101-47.305-1, are reasonable, i.e., commensurate with the fair market value of the property, and were independently arrived at in open competition, award shall be made with reasonable promptness by notice to the bidder whose bid, conforming to the invitation for bids, will be most advantageous to the Government, price and other factors considered. Any or all offers may be rejected when the head of the disposal agency or his designee determines it is in the public interest to do so.

§ 101-47.305-2 Equal offers.

Equal offers means two or more offers that are equal in all respects, taking into consideration the best interests of the Government. If equal acceptable offers are received for the same property, award shall be made by a drawing by lot limited to the equal acceptable offers received.

§ 101-47.305-3 Notice to unsuccessful bidders.

When an offer for surplus real property has been accepted, the disposal agency shall notify all other bidders of such acceptance and return their earnest money deposits, if any.

(b) Where the advertising does not result in the receipt of a bid at a price commensurate with the fair market value of the property, the highest bidder may, at the discretion of the head of the disposal agency or his designee and upon determination of responsiveness and bidder responsibility, be afforded an opportunity to increase his offered price. The bidder shall be given a reasonable period of time, not to exceed fifteen working days, to respond. At the time the bidder is afforded an opportunity to increase his bid, all other bids shall be rejected and bid deposits returned. Any sale at a price so increased may be concluded without regard to the provisions of §101-47.304-9 and §101-47.304-12.

§ 101-47.306 Absence of acceptable offers.

§ 101-47.306-1 Negotiations.

(c) The disposal agency shall allow a reasonable period of time within which the successful bidder shall consummate the transaction and shall notify the successful bidder of the period allowed.

(d) It is within the discretion of the head of the disposal agency or his designee to determine whether the procedure authorized by paragraph (b) of this §101-47.305-1 is followed or whether the bids shall be rejected and the property reoffered for sale on a publicly advertised competitive bid basis in accordance with the provisions of §101-47.304-7, or disposed of by negotiation pursuant to §101-47.306-1, or offered for

(a) When the head of the disposal agency or his designee determines that bid prices after advertising therefor (including the action authorized by the provisions of §101-47.305-1(b)) are not reasonable either as to all or some part of the property or were not independently arrived at in open competition and that a negotiated sale rather than a disposal by readvertising or under other applicable provisions of this subpart would better protect the public interest, the property or such part thereof may be disposed of by negotiated sale after rejection of all bids received: *Provided*, That no negotiated disposal may be made under this §101-47.306-1 unless:

(1) Notification of the intention to negotiate and reasonable opportunity to negotiate shall have been given by the agency head or his designee to each responsible bidder who submitted a bid pursuant to the advertising;

(2) The negotiated price is higher than the highest rejected bid price offered by any responsible bidder, as determined by the head of the agency or his designee; and

(3) The negotiated price is the highest negotiated price offered by any responsible prospective purchaser.

Federal Property Management Regulations

§ 101-47.307-2

(b) Any such negotiated disposal shall be subject to the applicable provisions of §§ 101-47.304-9 and 101-47.304-12.

§ 101-47.306-2 Defense Industrial Reserve properties.

In the event that any disposal agency is unable to dispose of any surplus industrial plant because of the application of the conditions and restrictions of the National Security Clause imposed under the Defense Industrial Reserve Act (50 U.S.C. 453), after making every practicable effort to do so, it shall notify the Secretary of Defense, indicating such modifications in the National Security Clause, if any, which in its judgment will make possible the disposal of the plant. Upon agreement by the Secretary of Defense to any or all of such modifications, the plant shall be reoffered for disposal subject to such modifications as may have been so agreed upon; or if such modifications are not agreed to, and upon request of the Secretary of Defense, the plant shall be transferred to the custody of GSA.

[40 FR 12078, Mar. 17, 1975]

§ 101-47.307 Conveyances.

§ 101-47.307-1 Form of deed or instrument of conveyance.

Disposals of real property shall be by quitclaim deed or deed without warranty in conformity with local law and practice, unless the disposal agency finds that another form of conveyance is necessary to obtain a reasonable price for the property or to render the title marketable, and unless the use of such other form of conveyance is approved by GSA.

§ 101-47.307-2 Conditions in disposal instruments.

(a) Where a sale is made upon credit, the purchaser shall agree by appropriate provisions to be incorporated in the disposal instruments, that he will not resell or lease (unless due to its character or type the property was offered without leasing restrictions by the disposal agency) the property, or any part thereof or interest therein, without the prior written authorization of the disposal agency and such disposal instruments in appropriate

cases may specifically provide for such authorization and/or future partial releases to be granted on terms which will adequately protect the Government's security for the credit extended to the purchaser.

(b) Except for exchange transactions initiated by the Federal Government for its own benefit, any disposition of land, or land and improvements located thereon, to public bodies by negotiation pursuant to § 101-47.304-9(4) shall include in the deed or other disposal instrument a covenant substantially as follows:

The Grantee covenants for itself, its heirs, successors, and assigns and every successor in interest to the property hereby conveyed, or any part thereof, that the said Grantee and such heirs, successors, and assigns shall not discriminate upon the basis of race, color, religion, or national origin in the use, occupancy, sale, or lease of the property, or in their employment practices conducted thereon. This covenant shall not apply, however, to the lease or rental of a room or rooms within a family dwelling unit; nor shall it apply with respect to religion to premises used primarily for religious purposes. The United States of America shall be deemed a beneficiary of this covenant without regard to whether it remains the owner of any land or interest therein in the locality of the property hereby conveyed and shall have the sole right to enforce this covenant in any court of competent jurisdiction.

(c) Any deed, lease, or other instrument executed to dispose of property under this subpart, subject to reservations, restrictions, or conditions as to the future use, maintenance, or transfer of the property shall recite all covenants, representations, and agreements pertaining thereto.

(d) Where the existence of hazardous substance activity has been brought to the attention of the disposal agency by the Standard Form 118 information provided in accordance with § 101-47.202-2(b)(10), the disposal agency shall incorporate such information into any deed, lease, or other instrument executed pursuant to part 101-47. See the language contained in § 101-47.304-14. In the case where the purchaser is a potentially responsible party (PRP) with respect to the hazardous substance activity, the language must be modified as appropriate to properly represent

§ 101-47.307-3

the liability of the PRP for any remedial action.

[29 FR 16126, Dec. 3, 1964, as amended at 33 FR 4408, Mar. 12, 1968; 56 FR 15049, Apr. 15, 1991]

§ 101-47.307-3 Distribution of conformed copies of conveyance instruments.

(a) Two conformed copies of any deed, lease, or other instrument containing reservations, restrictions, or conditions regulating the future use, maintenance, or transfer of the property shall be provided the agency charged with enforcement of such reservations, restrictions, or conditions.

(b) A conformed copy of the deed, lease, or other conveyance instrument shall be provided to the holding agency by the disposal agency.

§ 101-47.307-4 Disposition of title papers.

The holding agency shall, upon request, deliver to the disposal agency all title papers in its possession relating to the property reported excess. The disposal agency may transfer to the purchaser of the property, as a part of the disposal transaction, the pertinent records authorized by §101-11.404-2, to be so transferred. If the purchaser of the property wishes to obtain additional records, copies thereof may be furnished to the purchaser at an appropriate charge, as determined by the agency having custody of the records.

[33 FR 572, Jan. 17, 1968]

§ 101-47.307-5 Title transfers from Government corporations.

In order to facilitate the administration and disposition of real property when record title to such property is not in the name of the United States of America, the holding agency, upon request of the Administrator of General Services, shall deliver to the disposal agency a quitclaim deed, or other instrument of conveyance without warranty, expressed or implied, transferring all of the right, title, and interest of the holding agency in such property to the United States of America.

41 CFR Ch. 101 (7-1-01 Edition)

§ 101-47.307-6 Proceeds from disposals.

All proceeds (except so much thereof as may be otherwise obligated, credited, or paid under authority of those provisions of law set forth in section 204(b)-(e) of the Act (40 U.S.C. 485(b)-(e)), or the Independent Offices Appropriation Act, 1963 (76 Stat. 725) or in any later appropriation act) hereafter received from any sale, lease, or other disposition of surplus real property and related personal property shall be covered into the land and water conservation fund in the Treasury of the United States.

[30 FR 754, Jan. 23, 1965]

§ 101-47.308 Special disposal provisions.

§ 101-47.308-1 Power transmission lines.

(a) Pursuant and subject to the provisions of section 13(d) of the Surplus Property Act of 1944 (50 U.S.C. App. 1622(d)), which is continued in effect by section 602(a) of the Federal Property and Administrative Services Act of 1949, any State or political subdivision thereof, or any State or Government agency or instrumentality may certify to the disposal agency that a surplus power transmission line and the right-of-way acquired for its construction is needful for or adaptable to the requirements of a public or cooperative power project. Disposal agencies shall notify such State entities and Government agencies of the availability of such property in accordance with §101-47.303-2.

(b) Notwithstanding any other provisions of this subpart, whenever a State or political subdivision thereof, or a State or Government agency or instrumentality certifies that such property is needful for or adaptable to the requirements of a public or cooperative power project, the property may be sold for such utilization at the fair market value thereof.

(c) In the event a sale cannot be accomplished by reason of the price to be charged or otherwise and the certification is not withdrawn, the disposal agency shall report the facts involved to the Administrator of General Services, for a determination by him as to

Federal Property Management Regulations

§ 101-47.308-2

the further action to be taken to dispose of the property.

(d) Any power transmission line and right-of-way not disposed of pursuant to the provisions of this section shall be disposed of in accordance with other applicable provisions of this subpart, including, if appropriate, reclassification by the disposal agency.

§ 101-47.308-2 Property for public airports.

(a) Pursuant and subject to the provisions of section 13(g) of the Surplus Property Act of 1944 (49 U.S.C. 47151), airport property may be conveyed or disposed of to a State, political subdivision, municipality, or tax-supported institution for a public airport. Airport property is any surplus real property including improvements and personal property located thereon as a part of the operating unit (exclusive of property the highest and best use of which is determined by the Administrator of General Services to be industrial and which shall be so classified for disposal without regard to the provisions of this section) which, in the determination of the Administrator of the Federal Aviation Administration (FAA) is essential, suitable, or desirable for the development, improvement, operation, or maintenance of a public airport, as defined in the Federal Airport Act, as amended (49 U.S.C. 1101), or reasonably necessary to fulfill the immediate and foreseeable future requirements of the grantee for the development, improvement, operation, or maintenance of a public airport, including property needed to develop sources of revenue from nonaviation businesses at a public airport.

(b) The disposal agency shall notify eligible public agencies, in accordance with the provisions of § 101-47.303-2, that property which may be disposed of for use as a public airport under the Act of 1944, as amended, has been determined to be surplus. There shall be transmitted with the copy of each such notice when sent to the proper regional office of the Federal Aviation Administration, § 101-47.303-2(d), a copy of the holding agency's Report of Excess Real Property (Standard Form 118, with accompanying schedules).

(c) As promptly as possible after receipt of the copy of the notice given to eligible public agencies and the copy of Standard Form 118, the Federal Aviation Administration shall inform the disposal agency of the determination of the Administrator of the Federal Aviation Administration required by the provisions of the Act of 1944, as amended. The Federal Aviation Administration, thereafter, shall render such assistance to any eligible public agency known to have a need for the property for a public airport as may be necessary for such need to be considered in the development of a comprehensive and coordinated plan of use and procurement for the property. An application form and instructions for the preparation of an application shall be furnished to the eligible public agency by the disposal agency upon request.

(d) Whenever an eligible public agency has submitted a plan of use and application to acquire property for a public airport, in accordance with the provisions of § 101-47.303-2, the disposal agency shall transmit two copies of the plan and two copies of the application to the proper regional office of the Federal Aviation Administration. The Federal Aviation Administration shall promptly submit to the disposal agency a recommendation for disposal of the property for a public airport or shall inform the disposal agency that no such recommendation will be submitted.

(e) Upon receipt of such recommendation, the disposal agency may, with the approval of the head of the disposal agency or his designee, convey property recommended by the Federal Aviation Administration for disposal for a public airport to the eligible public agency, subject to the provisions of the Surplus Property Act of 1944, as amended. Approval for aviation areas shall be based on established FAA guidelines, criteria, and requirements for such areas. Approval for nonaviation revenue-producing areas shall be given only for such areas as are anticipated to generate net proceeds which do not exceed expected deficits for operation of the aviation area applied for at the airport.

(f) Any airport property not recommended by the Federal Aviation Administration for disposal pursuant to the provisions of this subsection for use as a public airport shall be disposed of in accordance with other applicable provisions of this subpart. However, the holding agency shall first be notified of the inability of the disposal agency to dispose of the property for use as a public airport and shall be allowed 30 days to withdraw the property from surplus or to waive any future interest in the property for public airport use.

(g) The Administrator of the Federal Aviation Administration has the sole responsibility for enforcing compliance with the terms and conditions of disposal, and for the reformation, correction, or amendment of any disposal instrument and the granting of releases and for taking any necessary action for recapturing such property in accordance with the provisions of the Act of October 1, 1949, 63 Stat. 700, and section 1402(c) of the Federal Aviation Act of 1958, 72 Stat. 807 (50 U.S.C. App. 1622a-1622e).

(h) In the event title to any such property is revested in the United States by reason of noncompliance with the terms and conditions of disposal, or other cause, the Administrator of the Federal Aviation Administration shall have accountability for the property and shall report the property to GSA as excess property in accordance with the provisions of §101-47.202.

(i) Section 23 of the Airport and Airway Development Act of 1970 (Airport Act of 1970) is not applicable to the transfer of airports to State and local agencies. The transfer of airports to State and local agencies may be made only under section 13(g) of the Surplus Property Act of 1944 which is continued in effect by the Act. Only property which the holding agency determines cannot be reported excess to GSA for disposition under the Act, but which, nevertheless, may be made available for use by a State or local public body for public airport purposes without being inconsistent with the Federal program of the holding agency, may be conveyed under section 23 of the Airport Act of 1970. In the latter instance,

section 23 may be used for the transfer of nonexcess land for airport development purposes providing that such real property does not constitute an entire airport. An entire, existing and established airport can only be disposed of to a State or eligible local government under section 13(g) of the Surplus Property Act of 1944.

[29 FR 16126, Dec. 3, 1964, as amended at 42 FR 46305, Sept. 15, 1977; 48 FR 1301, Jan. 12, 1983; 60 FR 35707, July 11, 1995]

§ 101-47.308-3 Property for use as historic monuments.

(a) Under section 203(k)(3) of the act, the disposal agency may, in its discretion, convey, without monetary consideration, to any State, political subdivision, instrumentalities thereof, or municipality, surplus real and related personal property for use as a historic monument for the benefit of the public provided the Secretary of the Interior has determined that the property is suitable and desirable for such use. No property shall be determined to be suitable or desirable for use as a historic monument except in conformity with the recommendation of the Advisory Board on National Parks, Historic Sites, Buildings, and Monuments. In addition, the disposal agency may authorize the use of property conveyed under subsection 203(k)(3) of the act or the Surplus Property Act of 1944, as amended, for revenue-producing activities if the Secretary of the Interior:

(1) Determines that such activities, as described in the applicant's proposed program of utilization, are compatible with the use of the property for historic monument purposes;

(2) Approves the grantee's plan for repair, rehabilitation, restoration, and maintenance of the property;

(3) Approves the grantee's plan for financing the repair, rehabilitation, restoration, and maintenance of the property. The plan shall not be approved unless it provides that all incomes in excess of costs of repair, rehabilitation, restoration, maintenance and a specified reasonable profit or payment that may accrue to a lessor, sublessor, or developer in connection with the management, operation, or development of the property for revenue producing activities shall be used by the grantee,

Federal Property Management Regulations

§ 101-47.308-4

lessor, sublessor, or developer, only for public historic preservation, park, or recreational purposes; and

(4) Examines and approves the grantee's accounting and financial procedures for recording and reporting on revenue-producing activities.

(b) The disposal agency shall notify State and areawide clearinghouses and eligible public agencies, in accordance with the provisions of §101-47.303-2, that property which may be disposed of for use as a historic monument has been determined to be surplus. A copy of the holding agency's Standard Form 118, Report of Excess Real Property, with accompanying schedules shall be transmitted with the copy of each such notice when it is sent to the proper regional office of the Bureau of Outdoor Recreation as provided in §101-47.303-2(d).

(c) Upon request, the disposal agency shall furnish eligible public agencies with an application form to acquire real property for permanent use as a historic monument and advise the potential applicant that it should consult with the appropriate Bureau of Outdoor Recreation Regional Office early in the process of developing the application.

(d) Eligible public agencies shall submit the original and two copies of the completed application to acquire real property for use as a historic monument in accordance with the provisions of §101-47.303-2 to the appropriate Bureau of Outdoor Recreation Regional Office which will forward one copy of the application to the appropriate regional office of the disposal agency. After consultation with the National Park Service, the Bureau of Outdoor Recreation shall promptly submit to the disposal agency the determination required of the Secretary of the Interior under section 203(k)(3) of the act for disposal of the property for a historic monument and compatible revenue-producing activities or shall inform the disposal agency that no such recommendation will be submitted.

(e) Upon receipt of the determination, the disposal agency may with the approval of the head of the disposal agency or his designee convey to an eligible public agency property determined by the Secretary of the Interior

to be suitable and desirable for use as a historic monument for the benefit of the public and for compatible revenue-producing activities subject to the provisions of section 203(k)(3) of the Act.

(f) The Secretary of the Interior has the responsibility for enforcing compliance with the terms and conditions of disposals; the reformation, correction, or amendment of any disposal instrument; the granting of releases; and any action necessary for recapturing such property in accordance with the provisions of section 203(k)(4) of the act. Any such action shall be subject to the disapproval of the head of the disposal agency.

(g) The Department of the Interior shall notify the appropriate GSA regional Real Property Division, Public Buildings Service, immediately by letter when title to such historic property is to be revested in the United States for noncompliance with the terms and conditions of disposal or for other cause. The notification shall cite the legal and administrative actions that the Department must take to obtain full title and possession of the property. In addition, it shall include an adequate description of the property, including any improvements constructed thereon since the original conveyance to the grantee. Upon receipt of a statement from the Department that title to the property has revested, GSA will assume custody and accountability of the property. However, the grantee shall be required to provide protection and maintenance of the property until such time as the title reverts to the Federal Government, including the period of any notice of intent to revert. Such protection and maintenance shall, at a minimum, conform to the standards prescribed in §101-47.4913.

[40 FR 22257, May 22, 1975, as amended at 49 FR 44472, Nov. 7, 1984]

§ 101-47.308-4 Property for educational and public health purposes.

(a) The head of the disposal agency or his designee is authorized, at his discretion:

(1) To assign to the Secretary of the Department of Education (ED) for disposal under section 203(k)(1) of the Act such surplus real property, including

buildings, fixtures, and equipment situated thereon, as is recommended by the Secretary as being needed for school, classroom, or other educational use, or

(2) To assign to the Secretary of Health and Human Services (HHS) for disposal under section 203(k)(1) of the Act such surplus real property, including buildings, fixtures, and equipment situated thereon, as is recommended by the Secretary as being needed for use in the protection of public health, including research.

(b) With respect to real property and related personal property which may be made available for assignment to ED or HHS for disposal under section 203(k)(1) of the Act for educational or public health purposes, the disposal agency shall notify eligible public agencies, in accordance with the provisions of § 101-47.303-2, that such property has been determined to be surplus. Such notice to eligible public agencies shall state that any planning for an educational or public health use, involved in the development of the comprehensive and coordinated plan of use and procurement for the property, must be coordinated with ED or HHS, as appropriate, and that an application form for such use of the property and instructions for the preparation and submission of an application may be obtained from ED or HHS. The requirement for educational or public health use of the property by an eligible public agency will be contingent upon the disposal agency's approval under paragraph (i) of this section, of a recommendation for assignment of Federal surplus real property received from ED or HHS and any subsequent transfer shall be subject to the disapproval of the head of the disposal agency as stipulated under section 203(k)(1) (A) or (B) of the Act and referenced in paragraph (j) of this section.

(c) With respect to surplus real property and related personal property which may be made available for assignment to either Secretary for disposal under section 203(k)(1) of the Act for educational or public health purposes to nonprofit institutions which have been held exempt from taxation under section 501(c)(3) of the Internal Revenue Code of 1954 (26 U.S.C. 501(c)(3)), ED or HHS may notify eligi-

ble nonprofit institutions, in accordance with the provisions of § 101-47.303-2(e), that such property has been determined to be surplus. Any such notice to eligible nonprofit institutions shall state that any requirement for educational or public health use of the property should be coordinated with the public agency declaring to the disposal agency an intent to develop and submit a comprehensive and coordinated plan of use and procurement for the property. The requirement for educational or public health use of the property by an eligible nonprofit institution will be contingent upon the disposal agency's approval, under paragraph (i) of this section, of an assignment recommendation received from ED or HHS and any subsequent transfer shall be subject to the disapproval of the head of the disposal agency as stipulated under section 203(k)(1) (A) or (B) of the Act and referenced in (j) below.

(d) ED and HHS shall notify the disposal agency within 20-calendar days after the date of the notice of determination of surplus if it has an eligible applicant interested in acquiring the property. Whenever ED or HHS has notified the disposal agency within the said 20-calendar day period of a potential educational or public health requirement for the property, ED or HHS shall submit to the disposal agency within 25-calendar days after the expiration of the 20-calendar day period, a recommendation for assignment of the property, or shall inform the disposal agency, within the 25-calendar day period, that a recommendation will not be made for assignment of the property.

(e) Whenever an eligible public agency has submitted a plan of use for property for an educational or public health requirement, in accordance with the provisions of § 101-47.303-2, the disposal agency shall transmit two copies of the plan to the regional office of ED or HHS as appropriate. ED or HHS shall submit to the disposal agency, within 25-calendar days after the date the plan is transmitted, a recommendation for assignment of the property to the Secretary of ED or HHS, or shall inform

the disposal agency, within the 25-calendar day period, that a recommendation will not be made for assignment of the property to ED or HHS as appropriate.

(f) Any assignment recommendation submitted to the disposal agency by ED or HHS shall set forth complete information concerning the educational or public health use, including: (1) Identification of the property, (2) the name of the applicant and the size and nature of its program, (3) the specific use planned, (4) the intended public benefit allowance, (5) the estimate of the value upon which such proposed allowance is based, and, (6) if the acreage or value of the property exceeds the standards established by the Secretary, an explanation therefor. ED or HHS shall furnish to the holding agency a copy of the recommendation, unless the holding agency is also the disposal agency.

(g) Holding agencies shall cooperate to the fullest extent possible with representatives of ED or HHS in their inspection of such property and in furnishing information relating thereto.

(h) In the absence of an assignment recommendation from ED or HHS submitted pursuant to § 101-47.308-4 (d) or (e), and received within the 25-calendar day time limit specified therein, the disposal agency shall proceed with other disposal action.

(i) If, after considering other uses for the property, the disposal agency approves the assignment recommendation from ED or HHS, it shall assign the property by letter or other document to the Secretary of ED or HHS as appropriate. If the recommendation is disapproved, the disposal agency shall likewise notify the appropriate Department. The disposal agency shall furnish to the holding agency a copy of the assignment, unless the holding agency is also the disposal agency.

(j) Subsequent to the receipt of the disposal agency's letter of assignment, ED or HHS shall furnish to the disposal agency a Notice of Proposed Transfer in accordance with section 203(k)(1) (A) or (B) of the Act. If the disposal agency has not disapproved the proposed transfer within 30-calendar days of the receipt of the Notice of Proposed

Transfer, ED or HHS may proceed with the transfer.

(k) ED or HHS shall furnish the Notice of Proposed Transfer within 35-calendar days after the disposal agency's letter of assignment and shall prepare the transfer documents and take all necessary actions to accomplish the transfer within 15-calendar days after the expiration of the 30-calendar day period provided for the disposal agency to consider the notice. ED or HHS shall furnish the disposal agency two conformed copies of deeds, leases or other instruments conveying the property under section 203(k)(1) (A) or (B) of the Act and all related documents containing restrictions or conditions regulating the future use, maintenance or transfer of the property.

(l) ED or HHS, as appropriate, has the responsibility for enforcing compliance with the terms and conditions of transfer; for the reformation, correction, or amendment of any transfer instrument; for the granting of releases; and for the taking of any necessary actions for recapturing such property in accordance with the provisions of section 203(k)(4) of the Act. Any such action shall be subject to the disapproval of the head of the disposal agency. Notice to the head of the disposal agency by ED or HHS of any action proposed to be taken shall identify the property affected, set forth in detail the proposed action, and state the reasons therefor.

(m) In each case of repossession under a terminated lease or reversion of title by reason of noncompliance with the terms or conditions of sale or other cause, ED or HHS shall, at or prior to such repossession or reversion of title, provide the appropriate GSA regional office with an accurate description of the real and related personal property involved. Standard Form 118, Report of Excess Real Property, and the appropriate schedules shall be used for this purpose. Upon receipt of advice from ED or HHS that such property has been repossessed or title has reverted, GSA will assume custody of and accountability for the property. However, the grantee shall be required to provide protection and maintenance for the property until such time as the title reverts to the

§ 101-47.308-5

41 CFR Ch. 101 (7-1-01 Edition)

Federal Government, including the period of any notice of intent to revert. Such protection and maintenance shall, at a minimum, conform to the standards prescribed in § 101-47.4913.

[49 FR 3465, Jan. 27, 1984]

§ 101-47.308-5 [Reserved]

§ 101-47.308-6 Property for providing self-help housing or housing assistance.

(a) Property for self-help housing or housing assistance, as defined in section 203(k)(6)(C) of the Federal Property and Administrative Services Act of 1949, as amended (40 U.S.C.), is property for low-income housing opportunities through the construction, rehabilitation, or refurbishment of self-help housing, under terms that require that:

(1) Any individual or family receiving housing or housing assistance constructed, rehabilitated, or refurbished through use of the property shall contribute a significant amount of labor toward the construction, rehabilitation, or refurbishment; and

(2) Dwellings constructed, rehabilitated, or refurbished through use of the property shall be quality dwellings that comply with local building and safety codes and standards and shall be available at prices below prevailing market prices.

NOTE TO PARAGRAPH (a): This program is separate from the program under Title V of the Stewart B. McKinney Act of 1987, which is covered in 41 CFR subpart 101-47.9 (Use of Federal Real Property To Assist the Homeless).

(b) The head of the disposal agency, or his/her designee, is authorized, at his/her discretion to assign to the Secretary of the Department of Housing and Urban Development (HUD) for disposal under section 203(k)(6) of the Act such surplus real property, including buildings, fixtures, and equipment situated thereon, as is recommended by the Secretary as being needed for providing self-help housing or housing assistance for low-income individuals or families.

(c) With respect to real property and related personal property which may be made available for assignment to HUD for disposal under section 203(k)(6) of the Act for self-help housing or housing assistance purposes, the

disposal agency shall notify eligible public agencies, in accordance with the provisions of § 101-47.303-2, that such property has been determined to be surplus. Such notice to eligible public agencies shall state that any planning for self-help housing or housing assistance use involved in the development of the comprehensive and coordinated plan of use and procurement for the property must be coordinated with HUD and that an application form for such use of the property and instructions for the preparation and submission of an application may be obtained from HUD. The requirement for self-help housing or housing assistance use of the property by an eligible public agency will be contingent upon the disposal agency's approval under paragraph (j) of this section and a recommendation for assignment of Federal surplus real property received from HUD. Any subsequent transfer shall be subject to the disapproval of the head of the disposal agency as stipulated under section 203(k)(6)(B) of the Act and referenced in paragraph (k) of this section.

(d) With respect to surplus real property and related personal property which may be made available for assignment to HUD for disposal under section 203(k)(6) of the Act for self-help housing or housing assistance purposes to nonprofit organizations that exist for the primary purpose of providing housing or housing assistance for low-income individuals or families, HUD may notify such eligible nonprofit organizations, in accordance with the provisions of § 101-47.303-2(e), that such property has been determined to be surplus. Any such notice to eligible nonprofit organizations shall state that any requirement for housing or housing assistance use of the property should be coordinated with the public agency declaring to the disposal agency an intent to develop and submit a comprehensive and coordinated plan of use and procurement for the property. The requirement for self-help housing or housing assistance use of the property by an eligible nonprofit organization will be contingent upon the disposal agency's approval, under paragraph (j) of this section, of an assignment recommendation received from

Federal Property Management Regulations

§ 101-47.308-6

HUD, and any subsequent transfer shall be subject to the disapproval of the head of the disposal agency as stipulated under section 203(k)(6)(B) of the Act and referenced in paragraph (k) of this section.

(e) HUD shall notify the disposal agency within 30-calendar days after the date of the notice of determination of surplus if it has an eligible applicant interested in acquiring the property. Whenever HUD has notified the disposal agency within the 30-calendar day period of a potential self-help housing or housing assistance requirement for the property, HUD shall submit to the disposal agency within 25-calendar days after the expiration of the 30-calendar day period, a recommendation for assignment of the property, or shall inform the disposal agency, within the 25-calendar day period, that a recommendation will not be made for assignment of the property.

(f) Whenever an eligible public agency has submitted a plan of use for property for a self-help housing or housing assistance requirement, in accordance with the provisions of §101-47.303-2, the disposal agency shall transmit two copies of the plan to the regional office of HUD. HUD shall submit to the disposal agency, within 25-calendar days after the date the plan is transmitted, a recommendation for assignment of the property to the Secretary of HUD, or shall inform the disposal agency, within the 25-calendar day period, that a recommendation will not be made for assignment of the property to HUD.

(g) Any assignment recommendation submitted to the disposal agency by HUD shall set forth complete information concerning the self-help housing or housing assistance use, including:

- (1) Identification of the property;
- (2) Name of the applicant and the size and nature of its program;
- (3) Specific use planned;
- (4) Intended public benefit allowance;
- (5) Estimate of the value upon which such proposed allowance is based; and
- (6) If the acreage or value of the property exceeds the standards established by the Secretary, an explanation therefor.

NOTE TO PARAGRAPH (g): HUD shall furnish to the holding agency a copy of the rec-

ommendation, unless the holding agency is also the disposal agency.

(h) Holding agencies shall cooperate to the fullest extent possible with representatives of HUD in their inspection of such property and in furnishing information relating thereto.

(i) In the absence of an assignment recommendation from HUD submitted pursuant to §101-47.308-6(e) or (f), and received within the 25-calendar day time limit specified therein, the disposal agency shall proceed with other disposal actions.

(j) If, after considering other uses for the property, the disposal agency approves the assignment recommendation from HUD, it shall assign the property by letter or other document to the Secretary of HUD. If the recommendation is disapproved, the disposal agency shall likewise notify the Secretary of HUD. The disposal agency shall furnish to the holding agency a copy of the assignment, unless the holding agency is also the disposal agency.

(k) Subsequent to the receipt of the disposal agency's letter of assignment, HUD shall furnish to the disposal agency a Notice of Proposed Transfer in accordance with section 203(k)(6)(B) of the Act. If the disposal agency has not disapproved the proposed transfer within 30-calendar days of the receipt of the Notice of Proposed Transfer, HUD may proceed with the transfer.

(l) HUD shall furnish the Notice of Proposed Transfer within 35-calendar days after the disposal agency's letter of assignment and shall prepare the transfer documents and take all necessary actions to accomplish the transfer within 15-calendar days after the expiration of the 30-calendar day period provided for the disposal agency to consider the notice. HUD shall furnish the disposal agency two conformed copies of deeds, leases or other instruments conveying the property under section 203(k)(6) of the Act and all related documents containing restrictions or conditions regulating the future use, maintenance or transfer of the property.

(m) HUD has the responsibility for enforcing compliance with the terms and conditions of transfer; for the reformation, correction, or amendment of

§ 101-47.308-7

any transfer instrument; for the granting of releases; and for the taking of any necessary actions for recapturing such property in accordance with the provisions of section 203(k)(4) of the Act. HUD maintains the same responsibility for properties previously conveyed under section 414(a) of the 1969 HUD Act. Any such action shall be subject to the disapproval of the head of the disposal agency. Notice to the head of the disposal agency by HUD of any action proposed to be taken shall identify the property affected, set forth in detail the proposed action, and state the reasons therefor.

(n) If any property previously conveyed under section 414(a) of the 1969 HUD Act, as amended, to an entity other than a public body is used for any purpose other than the purpose for which it was sold or leased within a period of 30 years of the conveyance, it shall revert to the United States (or, in the case of leased property, the lease shall terminate) unless the appropriate Secretary (HUD or the Secretary of Agriculture (USDA)) and the Administrator of General Services, after the expiration of the first 20 years of such period, approve the use of the property for such other purpose.

(o) In each case of repossession under a terminated lease or reversion of title by reason of noncompliance with the terms or conditions of sale or other cause, HUD (or USDA for property conveyed through the former Farmers Home Administration program under section 414(a) of the 1969 HUD Act) shall, at or prior to such repossession or reversion of title, provide the appropriate GSA regional office with an accurate description of the real and related personal property involved. Standard Form 118, Report of Excess Real Property, and the appropriate schedules shall be used for this purpose. Upon receipt of advice from HUD (or USDA) that such property has been repossessed or title has reverted, GSA will act upon the Standard Form 118. The grantee shall be required to provide protection and maintenance for the property until such time as the title reverts to the Federal Government, including the period of any notice of intent to revert. Such protection and maintenance shall, at a min-

41 CFR Ch. 101 (7-1-01 Edition)

imum, conform to the standards prescribed in §101-47.4913.

[64 FR 5617, Feb. 4, 1999]

§ 101-47.308-7 Property for use as public park or recreation areas.

(a) The head of the disposal agency or his designee is authorized, in his discretion, to assign to the Secretary of the Interior for disposal under section 203(k)(2) of the Act for public park or recreation purposes, such surplus real property, including buildings, fixtures, and equipment situated thereon, as is recommended by the Secretary as being needed for use as a public park or recreation area for disposal by the Secretary to a State, political subdivision, instrumentalities thereof, or municipality.

(b) The disposal agency shall notify established State and regional or metropolitan clearinghouses and eligible public agencies, in accordance with the provisions of §101-47.303-2, that property which may be disposed of for use as a public park or recreation area has been determined to be surplus. There shall be transmitted with the copy of each such notice, when sent to the proper field office of the Bureau of Outdoor Recreation, a copy of the holding agency's Report of Excess Real Property (Standard Form 118, with accompanying schedules).

(c) An application form to acquire property for permanent use as a public park or recreation area and instructions for the preparation of the application shall be furnished by the Department of the Interior upon request.

(d) The Department of the Interior shall notify the disposal agency within 20 calendar days after the date of the notice of determination of surplus if it has an eligible applicant interested in acquiring the property under section 203(k)(2) of the Act.

(e) Holding agencies shall cooperate to the fullest extent possible with representatives of the Department of the Interior in their inspection of such property and in furnishing information relating thereto.

(f) The Department of the Interior shall advise the disposal agency and request assignment of the property for disposition under section 203(k)(2) of

Federal Property Management Regulations

§ 101-47.308-7

the Act, as amended, within 25 calendar days after the expiration of the 20-calendar-day period specified in paragraph (d) of this section.

(g) Any recommendation submitted by the Department of the Interior pursuant to paragraph (f) of this section shall set forth complete information concerning the plans for use of the property as a public park or recreation area, including (1) identification of the property, (2) the name of the applicant, (3) the specific use planned, and (4) the intended public benefit allowance. A copy of the application together with any other pertinent documentation shall be submitted with the recommendation.

(h) In the absence of a notice under paragraph (d) of this section or a request under paragraph (f) of this section, the disposal agency shall proceed with the appropriate disposal action.

(i) If, after considering other uses for the property, the disposal agency approves the assignment recommendation from the Department of the Interior, it shall assign the property by letter or other document to the Secretary of the Interior. If the recommendation is disapproved, the disposal agency shall likewise notify the Secretary. The disposal agency shall furnish to the holding agency a copy of the assignment, unless the holding agency is also the disposal agency.

(j) Subsequent to the receipt of the disposal agency's letter of assignment, the Secretary of the Interior shall furnish to the disposal agency a Notice of Proposed Transfer, in accordance with section 203(k)(2)(A) of the Act. If the disposal agency has not disapproved the proposed transfer within 30-calendar days of the receipt of the Notice of Proposed Transfer, the Secretary may proceed with the transfer.

(k) The disposal agency may, where appropriate, make the assignment subject to the Department of the Interior requiring the applicant to bear the cost of any out-of-pocket expenses necessary to accomplish the transfer of the property, such as surveys, fencing, security of the remaining property or otherwise.

(l) In the absence of the notice of disapproval by the disposal agency upon expiration of the 30-day period, or upon

earlier advice from the disposal agency of no objection to the proposed transfer, the Department of the Interior may place the applicant in possession of the property as soon as practicable in order to minimize the Government's expense of protection and maintenance of the property. As of the date of assumption of possession of the property, or the date of conveyance, whichever occurs first, the applicant shall assume responsibility for care and handling and all risks of loss or damage to the property, and shall have all obligations and liabilities of ownership.

(m) The Department of the Interior shall furnish the Notice of Proposed Transfer within 35-calendar days after the disposal agency's letter of assignment and shall take all necessary actions to accomplish the transfer within 15-calendar days after the expiration of the 30-calendar day period provided for the disposal agency to consider the notice.

(n) The deed of conveyance of any surplus real property transferred under the provision of section 202(k)(2) of the Act shall provide that all such property be used and maintained for the purpose for which it was conveyed in perpetuity, and that in the event that such property ceases to be used or maintained for such purpose during such period, all or any portion of such property shall in its then existing condition, at the option of the United States, revert to the United States and may contain such additional terms, reservations, restrictions, and conditions as may be determined by the Secretary of the Interior to be necessary to safeguard the interest of the United States.

(o) The Department of the Interior shall furnish the disposal agency two conformed copies of deeds, leases, or other instruments conveying property under section 203(k)(2) of the Act and related documents containing reservations, restrictions, or conditions regulating the future use, maintenance or transfer of the property.

(p) The Secretary of the Interior has the responsibility for enforcing compliance with the terms and conditions of transfer; the reformation, correction, or amendment of any transfer instrument; the granting of releases; and any

necessary actions for recapturing such property in accordance with the provisions of section 202(k)(4) of the Act. Any such action shall be subject to the disapproval of the head of the disposal agency. Notice to the head of the disposal agency by the Secretary of any action proposed to be taken shall identify the property affected, set forth in detail the proposed action, and state the reasons therefor.

(q) The Department of the Interior shall notify the appropriate GSA regional office immediately by letter when title to property transferred for use as a public park or recreation area is to be revested in the United States for noncompliance with the terms or conditions of disposal or for other cause. The notification shall cite the legal and administrative actions that the Department must take to obtain full title and possession of the property. In addition, it shall include an adequate description of the property, including any improvements constructed thereon since the original conveyance to the grantee. Upon receipt of a statement from the Department that title to the property has revested, GSA will assume custody of and accountability for the property. However, the grantee shall be required to provide protection and maintenance for the property until such time as the title reverts to the Federal Government, including the period of any notice of intent to revert. Such protection and maintenance shall, at a minimum, conform to the standards prescribed in §101-47.4913.

[36 FR 9776, May 28, 1971, as amended at 49 FR 3467, Jan. 27, 1984]

§ 101-47.308-8 Property for displaced persons.

(a) Pursuant to section 218 of the Uniform Relocation Assistance and Real Property Acquisition Policies Act of 1970, the disposal agency is authorized to transfer surplus real property to a State agency, as hereinafter provided, for the purpose of providing replacement housing under title II of this Act for persons who are to be displaced by Federal or federally assisted projects.

(b) Upon receipt of the notice of surplus determination (§101-47.204-1(a)),

any Federal agency having a requirement for such property for housing for displaced persons may solicit applications from eligible State agencies.

(c) Federal agencies shall notify the disposal agency within 20 calendar days after the date of the notice of determination of surplus if it is able to interest an eligible State agency in acquiring the property under section 218.

(d) Both holding and disposal agencies shall cooperate, to the fullest extent possible, with Federal and State agency representatives in their inspection of such property and in furnishing information relating thereto.

(e) The interested Federal agency shall advise the disposal agency and request transfer of the property to the selected State agency under section 218 within 25 calendar days after the expiration of the 20-calendar-day period specified in §101-47.308-8(c).

(f) Any request submitted by a Federal agency pursuant to §101-47.308-8(e) shall be in the form of a letter addressed to the appropriate GSA regional office and shall set forth the following information:

(1) Identification of the property by name, location, and control number;

(2) A request that the property be transferred to a specific State agency including the name and address and a copy of the State agency's application or proposal;

(3) A certification by the appropriate Federal agency official that the property is required for housing for displaced persons pursuant to section 218, that all other options authorized under title II of the Act have been explored and replacement housing cannot be found or made available through those channels, and that the Federal or federally assisted project cannot be accomplished unless the property is made available for replacement housing;

(4) Any special terms and conditions that the Federal agency desires to include in conveyance instruments to insure that the property is used for the intended purpose;

(5) Identification by name and proposed location of the Federal or federally assisted project which is creating the requirement;

(6) Purpose of the project;

Federal Property Management Regulations

§ 101-47.308-9

(7) Citation of enabling legislation or authorization for the project when appropriate;

(8) A detailed outline of steps taken to obtain replacement housing for displaced persons as authorized under title II of the Act; and

(9) Arrangements that have been made to construct replacement housing on the surplus property and to insure that displaced persons will be provided housing in the development.

(g) In the absence of a notice under § 101-47.308-8(c) or a request under § 101-47.308-8(e), the disposal agency shall proceed with the appropriate disposal action.

(h) If, after considering other uses for the property, the disposal agency determines that the property should be made available for replacement housing under section 218, it shall transfer the property to the designated State agency on such terms and conditions as will protect the interest of the United States, including the payment or the agreement to pay to the United States all amounts received by the State agency from any sale, lease, or other disposition of the property for such housing. The sale, lease, or other disposition of the property by the State agency shall be at the fair market value as approved by the disposal agency, unless a compelling justification is offered for disposal of the property at less than fair market value, in which event the disposal may be made at such other value as is approved by the disposal agency.

(i) The State agency shall bear the costs of any out-of-pocket expenses necessary to accomplish the transfer of the property, such as costs of surveys, fencing, or security of the remaining property.

(j) The disposal agency, if it approves the request, shall transfer the property to the designated State agency. If the request is disapproved, the disposal agency shall notify the Federal agency requesting the transfer. The disposal agency shall furnish the holding agency a copy of the transfer or notice of disapproval, and the Federal agency requesting the transfer a copy of the transfer when appropriate.

[36 FR 11439, June 12, 1971]

§ 101-47.308-9 Property for correctional facility, law enforcement, or emergency management response purposes.

(a) Under section 203(p)(1) of the Act, the head of the disposal agency or designee may, in his/her discretion, convey, without monetary consideration, to any State, or to those governmental bodies named therein, or to any political subdivision or instrumentality thereof, surplus real and related personal property for:

(1) Correctional facility purposes, provided the Attorney General has determined that the property is required for such purposes and has approved an appropriate program or project for the care or rehabilitation of criminal offenders;

(2) Law enforcement purposes, provided the Attorney General has determined that the property is required for such purposes; and

(3) Emergency management response purposes, including fire and rescue services, provided the Director of the Federal Emergency Management Agency has determined that the property is required for such purposes.

(b) The disposal agency shall provide prompt notification to the Office of Justice Programs (OJP), Department of Justice (DOJ), and the Federal Emergency Management Agency (FEMA) of the availability of surplus properties. Included in the notification to OJP and FEMA will be a copy of the holding agency's Standard Form 118, Report of Excess Real Property, with accompanying schedules.

(c) With respect to real property and related personal property which may be made available for disposal under section 203(p)(1) of the Act for correctional facility, law enforcement, or emergency management response purposes, OJP or FEMA shall convey notices of availability of properties to the appropriate State and local public agencies. Such notice shall state that any planning for correctional facility, law enforcement, or emergency management response use involved in the development of a comprehensive and coordinated plan of use and procurement for the property must be coordinated and approved by the OJP or

FEMA, as appropriate, and that an application form for such use of the property and instructions for the preparation and submission of an application may be obtained from OJP or FEMA. OJP defines the term "law enforcement" to mean "any activity involving the control or reduction of crime and juvenile delinquency, or enforcement of the criminal law, including investigative activities such as laboratory functions as well as training." The requirement for correctional facility, law enforcement, or emergency management response use of the property by an eligible public agency will be contingent upon the disposal agency's approval under paragraph (g) of this section of a determination:

(1) By DOJ that identifies surplus property required for correctional facility use under an appropriate program or project for the care of rehabilitation of criminal offenders, or for law enforcement use; or

(2) By FEMA that identifies surplus property required for emergency management response use.

(d) OJP or FEMA shall notify the disposal agency within 30-calendar days after the date of the notice of determination of surplus if there is an eligible applicant interested in acquiring the property. Whenever OJP or FEMA has notified the disposal agency within the said 30-calendar day period of a potential correctional facility, law enforcement, or emergency management response requirement for the property, OJP or FEMA shall submit to the disposal agency within 25-calendar days after the expiration of the 30-calendar day period, a determination indicating a correctional facility requirement for the property and approving an appropriate program or project for the care or rehabilitation of criminal offenders, a law enforcement requirement, or an emergency management response requirement, or shall inform the disposal agency, within the 25-calendar day period, that the property will not be required for correctional facility, law enforcement, or an emergency management response use.

(e) Any determination submitted to the disposal agency by DOJ or FEMA shall set forth complete information concerning the correctional facility,

law enforcement, or emergency management response use, including:

(1) Identification of the property;

(2) Certification that the property is required for correctional facility, law enforcement, or emergency management response use;

(3) A copy of the approved application which defines the proposed plan of use; and

(4) The environmental impact of the proposed correctional facility, law enforcement, or emergency management response use.

(f) Both holding and disposal agencies shall cooperate to the fullest extent possible with Federal and State agency representatives in their inspection of such property and in furnishing information relating thereto.

(g) If, after considering other uses for the property, the disposal agency approves the determination by DOJ or FEMA, it shall convey the property to the appropriate grantee. If the determination is disapproved, or in the absence of a determination from DOJ or FEMA submitted pursuant to §101-47.308-9(d), and received within the 25-calendar day time limit specified therein, the disposal agency shall proceed with other disposal actions. The disposal agency shall notify OJP or FEMA 10 days prior to any announcement of a determination to either approve or disapprove an application for correctional, law enforcement, or emergency management response purposes and shall furnish to OJP or FEMA a copy of the conveyance documents.

(h) The deed of conveyance of any surplus real property transferred under the provisions of section 203(p)(1) of the Act shall provide that all such property be used and maintained for the purpose for which it was conveyed in perpetuity and that in the event such property ceases to be used or maintained for such purpose during such period, all or any portion of such property shall in its then existing condition, at the option of the United States, revert to the United States and may contain such additional terms, reservations, restrictions, and conditions as may be determined by the Administrator of General Services to be

necessary to safeguard the interest of the United States.

(i) The Administrator of General Services has the responsibility for enforcing compliance with the terms and conditions of disposals; the reformation, correction, or amendment of any disposal instrument; the granting of releases; and any action necessary for recapturing such property in accordance with the provisions of section 203(p)(3) of the Act.

(j) The OJP or FEMA will notify GSA upon discovery of any information indicating a change in use and, upon request, make a redetermination of continued appropriateness of the use of a transferred property.

(k) In each case of repossession under a reversion of title by reason of non-compliance with the terms of the conveyance documents or other cause, OJP or FEMA shall, at or prior to such repossession, provide the appropriate GSA regional office with an accurate description of the real and related personal property involved. Standard Form 118, Report of Excess Real Property, and the appropriate schedules shall be used for this purpose. Upon receipt of advice from OJP or FEMA that such property has been reposessed and/or title has reverted, GSA will act upon the Standard Form 118. The grantee shall be required to provide protection and maintenance for the property until such time as the title reverts to the Federal Government, including the period of any notice of intent to revert. Such protection and maintenance shall, at a minimum, conform to the standards prescribed in § 101-47.4913.

[52 FR 9832, Mar. 27, 1987, as amended at 64 FR 5618, Feb. 4, 1999]

§ 101-47.308-10 Property for port facility use.

(a) Under section 203(q)(1) of the Act, in his/her discretion, the Administrator, the Secretary of the Department of Defense (DOD) in the case of property located at a military installation closed or realigned pursuant to a base closure law, or the designee of either of them, may, as the disposal agency, assign to the Secretary of the Department of Transportation (DOT) for conveyance, without monetary con-

sideration, to any State, or to those governmental bodies named therein, or to any political subdivision, municipality, or instrumentality thereof, such surplus real and related personal property, including buildings, fixtures, and equipment situated thereon, as is recommended by DOT as being needed for the development or operation of a port facility.

(b) The disposal agency shall notify established State and regional or metropolitan clearinghouses and eligible public agencies, in accordance with the provisions of § 101-47.303-2, that property which may be disposed of for use in the development or operation of a port facility has been determined to be surplus. A copy of such notice shall be transmitted to DOT accompanied by a copy of the holding agency's Report of Excess Real Property (Standard Form 118 and supporting schedules).

(c) The notice to eligible public agencies shall state:

(1) That any planning for the development or operation of a port facility, involved in the development of the comprehensive and coordinated plan of use and procurement for the property, must be coordinated with DOT;

(2) That any party interested in acquiring the property for use as a port facility must contact the Department of Transportation, Maritime Administration, for instructions concerning submission of an application; and

(3) That the requirement for use of the property in the development or operation of a port facility will be contingent upon approval by the disposal agency, under paragraph (i) of this section, of a recommendation from DOT for assignment of the property to DOT and that any subsequent conveyance shall be subject to the disapproval of the head of the disposal agency as stipulated under section 203(q)(2) of the Act and referenced in paragraph (j) of this subsection.

(d) DOT shall notify the disposal agency within 20 calendar-days after the date of the notice of determination of surplus if there is an eligible applicant interested in acquiring the property. Whenever the disposal agency, has been so notified of a potential port facility requirement for the property,

DOT shall submit to the disposal agency, within 25 calendar-days after the expiration of the 20-calendar-day notification period, either a recommendation for assignment of the property or a statement that a recommendation will not be submitted.

(e) Whenever an eligible public agency has submitted a plan of use for property for a port facility requirement, in accordance with the provisions of § 101-47.303-2, the disposal agency shall transmit two copies of the plan to DOT. DOT shall either submit to the disposal agency, within 25 calendar-days after the date the plan is transmitted, a recommendation for assignment of the property to DOT, or inform the disposal agency, within the 25-calendar-day period, that a recommendation will not be made for assignment of the property to DOT.

(f) Any assignment recommendation submitted to the disposal agency by DOT shall be accompanied by a copy of the explanatory statement required under section 203(q)(3)(C) of the Act and shall set forth complete information concerning the contemplated port facility use, including:

- (1) An identification of the property;
- (2) An identification of the applicant;
- (3) A copy of the approved application, which defines the proposed plan of use of the property;
- (4) A statement that DOT's determination that the property is located in an area of serious economic disruption was made in consultation with the Secretary of Labor; and
- (5) A statement that DOT's approval of the economic development plan associated with the plan of use of the property was made in consultation with the Secretary of Commerce.

(g) Holding agencies shall cooperate to the fullest extent possible with representatives of DOT and the Secretary of Commerce in their inspection of such property, and of the Secretary of Labor in affirming that the property is in an area of serious economic disruption, and in furnishing any information relating thereto.

(h) In the absence of an assignment recommendation from DOT submitted pursuant to paragraph (d) or (e) of this section, and received within the 25-calendar-day time limit specified therein,

the disposal agency shall proceed with other disposal action.

(i) If, after considering other uses for the property, the disposal agency approves the assignment recommendation from DOT, it shall assign the property by letter or other document to DOT. If the recommendation is disapproved, the disposal agency shall likewise notify DOT. The disposal agency shall furnish to the holding agency a copy of the assignment, unless the holding agency is also the disposal agency.

(j) Subsequent to the receipt of the letter of assignment from the disposal agency, DOT shall furnish to the disposal agency, a Notice of Proposed Conveyance in accordance with section 203(q)(2) of the Act. If the disposal agency has not disapproved the proposed transfer within 35 calendar-days of the receipt of the Notice of Proposed Conveyance, DOT may proceed with the conveyance.

(k) DOT shall furnish the Notice of Proposed Conveyance within 35 calendar-days after the date of the letter of assignment from the disposal agency, prepare the conveyance documents, and take all necessary actions to accomplish the conveyance within 15 calendar-days after the expiration of the 30-calendar-day period provided for the disposal agency to consider the notice. DOT shall furnish the disposal agency two conformed copies of the instruments conveying property under subsection 203(q) of the Act and all related documents containing restrictions or conditions regulating the future use, maintenance, or transfer of the property.

(l) DOT has the responsibility for enforcing compliance with the terms and conditions of conveyance; for reformation, correction, or amendment of any instrument of conveyance; for the granting of release; and for the taking of any necessary actions for recapturing such property in accordance with the provisions of subsection 203(q)(4) of the Act. Any such action shall be subject to the disapproval of the head of the disposal agency. Notice to the head of the disposal agency, by DOT, of any action proposed to be

Federal Property Management Regulations

§ 101-47.311

taken shall identify the property affected, set forth in detail the proposed action, and state the reasons therefor.

(m) In each case of repossession under a reversion of title by reason of noncompliance with the terms or conditions of conveyance or other cause, DOT shall, at or prior to such reversion of title, provide the appropriate GSA regional office, with an accurate description of the real and related personal property involved. Standard Form 118, Report of Excess Real Property, and appropriate accompanying schedules shall be used for this purpose. Upon receipt of advice from DOT that such property has been repossessed, GSA will review and act upon the Standard Form 118. However, the grantee shall be required to provide protection and maintenance for the property until such time as the title reverts to the Federal Government, including the period of any notice of intent to revert. Such protection and maintenance shall, at a minimum, conform to the standards prescribed in §101-47.4913.

[60 FR 35707, July 11, 1995]

§ 101-47.309 Disposal of leases, permits, licenses, and similar instruments.

The disposal agency may, subject to such reservations, restrictions, and conditions, if any, as the disposal agency deems necessary properly to protect the interests of the United States against liability under a lease, permit, license, or similar instrument:

(a) Dispose of the lease or other instrument subject to assumption by the transferee of the obligations in the lease or other instrument unless a transfer is prohibited by the terms of the lease or other instrument; or

(b) Terminate the lease or other instrument by notice or negotiated agreement; and

(c) Dispose of any surplus Government-owned improvements located on the premises in the following order by any one or more of the following methods:

(1) By disposition of all or a portion thereof to the transferee of the lease or other instrument (not applicable when the lease or other instrument is terminated);

(2) By disposition to the owner of the premises or grantor of a sublease, as the case may be, (i) in full satisfaction of a contractual obligation of the Government to restore the premises, or (ii) in satisfaction of a contractual obligation of the Government to restore the premises plus the payment of a money consideration to the Government by the owner or grantor, as the case may be, that is fair and reasonable under the circumstances, or (iii) in satisfaction of a contractual obligation of the Government to restore the premises plus the payment by the Government to the owner or grantor, as the case may be, of a money consideration that is fair and reasonable under the circumstances; or

(3) By disposition for removal from the premises.

Provided, That any negotiated disposals shall be subject to the applicable provisions of §§101-47.304-9 and 101-47.30-12. The cancellation of the Government's restoration obligations in return for the conveyance of the Government-owned improvements to the lessor is considered a settlement of a contractual obligation rather than a disposal of surplus real property and, therefore, is not subject to the provisions of §§101-47.304-9 and 101-47.304-12.

[29 FR 16126, Dec. 3, 1964, as amended at 31 FR 16780, Dec. 31, 1966]

§ 101-47.310 Disposal of structures and improvements on Government-owned land.

In the case of Government-owned land, the disposal agency may dispose of structures and improvements with the land or separately from the land: *Provided*, That prefabricated movable structures such as Butler-type storage warehouses, and quonset huts, and housetrailers (with or without undercarriages) reported to GSA with the land on which they are located, may, in the discretion of GSA, be designated for disposal as personal property for off-site use.

§ 101-47.311 Disposal of residual personal property.

(a) Any related personal property reported to GSA on Standard Form 118

§ 101-47.312

which is not disposed of by GSA as related to the real property, shall be designated by GSA for disposal as personal property.

(b) Any related personal property which is not disposed of by the holding agency, pursuant to the authority contained in §101-47.302, or authority otherwise delegated by the Administrator of General Services as related to the real property, shall be disposed of under the applicable provisions of part 101-45.

§ 101-47.312 Non-Federal interim use of property.

(a) A lease or permit may be granted by the holding agency with the approval of the disposal agency, for non-Federal interim use of surplus property; *Provided*, That such lease or permit shall be for a period not exceeding 1 year and shall be made revocable on not to exceed 30 days' notice by the disposal agency: And provided further, That the use and occupancy will not interfere with, delay, or retard the disposal of the property. In such cases, an immediate right of entry to such property may be granted pending execution of the formal lease or permit. The lease or permit shall be for a money consideration and shall be on such other terms and conditions as are deemed appropriate to properly protect the interest of the United States. Any negotiated lease or permit under this section shall be subject to the applicable provisions of §§101-47.304-9 and 101-47.304-12, except that no explanatory statement to the appropriate committees of the Congress need to be prepared with respect to a negotiated lease or permit providing for an annual net rental of \$100,000 or less, and termination by either part on 30 days' notice.

(b) [Reserved]

[54 FR 41245, Oct. 6, 1989]

§ 101-47.313 Easements.

§ 101-47.313-1 Disposal of easements to owner of servient estate.

The disposal agency may dispose of an easement to the owner of the land which is subject to the easement when the continued use, occupancy, or control of the easement is not needed for

41 CFR Ch. 101 (7-1-01 Edition)

the operation, production, use, or maintenance of property owned or controlled by the Government. A determination shall be made by the disposal agency as to whether the disposal shall be with or without consideration to the Government on the basis of all the circumstances and factors involved and with due regard to the acquisition cost of the easement to the Government. The extent of such consideration shall be regarded as the appraised fair market value of the easement. The disposal agency shall document the circumstances and factors leading to such determination and retain such documentation in its files.

§ 101-47.313-2 Grants of easements in or over Government property.

The disposal agency may grant easements in or over real property on appropriate terms and conditions: *Provided*, That where the disposal agency determines that the granting of such easement decreases the value of the property, the granting of the easement shall be for a consideration not less than the amount by which the fair market value of the property is decreased.

§ 101-47.314 Compliance.

§ 101-47.314-1 General.

Subject to the provisions of §101-47.314-2(a), requiring referral of criminal matters to the Department of Justice, each disposal agency shall perform such investigatory functions as are necessary to insure compliance with the provisions of the Act and with the regulations, orders, directives, and policy statements of the Administrator of General Services.

§ 101-47.314-2 Extent of investigations.

(a) *Referral to other Government agencies.* All information indicating violations by any person of Federal criminal statutes, or violations of section 209 of the Act, including but not limited to fraud against the Government, mail fraud, bribery, attempted bribery, or criminal collusion, shall be referred immediately to the Department of Justice for further investigation and disposition. Each disposal agency shall make available to the Department of

Federal Property Management Regulations

§ 101-47.401-2

Justice, or to such other governmental investigating agency to which the matter may be referred by the Department of Justice, all pertinent information and evidence concerning the indicated violations; shall desist from further investigation of the criminal aspects of such matters except upon the request of the Department of Justice; and shall cooperate fully with the agency assuming final jurisdiction in establishing proof of criminal violations. After making the necessary referral to the Department of Justice, inquiries conducted by disposal agency compliance organizations shall be limited to obtaining information for administrative purposes. Where irregularities reported or discovered involve wrongdoing on the part of individuals holding positions in Government agencies other than the agency initiating the investigation, the case shall be reported immediately to the Administrator of General Services for an examination in the premises.

(b) *Compliance reports.* A written report shall be made of all compliance investigations conducted by each agency compliance organization. Each disposal agency shall maintain centralized files of all such reports at its respective departmental offices. Until otherwise directed by the Administrator of General Services, there shall be transmitted promptly to the Administrator of General Services one copy of any such report which contains information indicating criminality on the part of any person or indicating noncompliance with the Act or with the regulations, orders, directives and policy statements of the Administrator of General Services. In transmitting such reports to the Administrator of General Services, the agency shall set forth the action taken or contemplated by the agency to correct the improper conditions established by the investigation. Where any matter is referred to the Department of Justice, a copy of the letter of referral shall be transmitted to the Administrator of General Services.

Subpart 101-47.4—Management of Excess and Surplus Real Property

§ 101-47.400 Scope of subpart.

This subpart prescribes the policies and methods governing the physical care, handling, protection, and maintenance of excess real property and surplus real property, including related personal property, within the States of the Union, the District of Columbia, the Commonwealth of Puerto Rico, American Samoa, Guam, the Trust Territory of the Pacific Islands, and the Virgin Islands.

[47 FR 4522, Feb. 1, 1982]

§ 101-47.401 General provisions of subpart.

§ 101-47.401-1 Policy.

It is the policy of the Administrator of General Services:

(a) That the management of excess real property and surplus real property, including related personal property, shall provide only those minimum services necessary to preserve the Government's interest therein, realizable value of the property considered.

(b) To place excess real property and surplus real property in productive use through interim utilization: *Provided*, That such temporary use and occupancy will not interfere with, delay, or retard its transfer to a Federal agency or disposal.

(c) That excess and surplus real property which is dangerous to the public health or safety shall be destroyed or rendered innocuous.

§ 101-47.401-2 Definitions.

As used in this subpart, the following terms shall have the meanings set forth below:

(a) *Maintenance.* The upkeep of property only to the extent necessary to offset serious deterioration; also such operation of utilities, including water supply and sewerage systems, heating,

§ 101-47.401-3

plumbing, and air-conditioning equipment, as may be necessary for fire protection, the needs of interim tenants, and personnel employed at the site, and the requirements for preserving certain types of equipment.

(b) *Repairs.* Those additions or changes that are necessary for the protection and maintenance of property to deter or prevent excessive or rapid deterioration or obsolescence, and to restore property damaged by storm, flood, fire, accident, or earthquake.

§ 101-47.401-3 Taxes and other obligations.

Payments of taxes or payments in lieu of taxes (in the event of the enactment hereafter of legislation by Congress authorizing such payments upon Government-owned property which is not legally assessable), rents, and insurance premiums and other obligations pending transfer or disposal shall be the responsibility of the holding agency.

§ 101-47.401-4 Decontamination.

The holding agency shall be responsible for all expense to the Government and for the supervision of decontamination of excess and surplus real property that has been subjected to contamination with hazardous materials of any sort. Extreme care must be exercised in the decontamination, and in the management and disposal of contaminated property in order to prevent such properties becoming a hazard to the general public. The disposal agency shall be made cognizant of any and all inherent hazards involved relative to such property in order to protect the general public from hazards and to preclude the Government from any and all liability resulting from indiscriminate disposal or mishandling of contaminated property.

§ 101-47.401-5 Improvements or alterations.

Improvements or alterations which involve rehabilitation, reconditioning, conversion, completion, additions, and replacements in structures, utilities, installations, and land betterments, may be considered in those cases where disposal cannot otherwise be made, but no commitment therefor shall be en-

41 CFR Ch. 101 (7-1-01 Edition)

tered into without prior approval of GSA.

§ 101-47.401-6 Interim use and occupancy.

When a revocable agreement to place excess real property or surplus real property in productive use has been made, the agency executing the agreement shall be responsible for the servicing thereof.

§ 101-47.402 Protection and maintenance.

§ 101-47.402-1 Responsibility.

The holding agency shall retain custody and accountability for excess and surplus real property including related personal property and shall perform the protection and maintenance of such property pending its transfer to another Federal agency or its disposal. Guidelines for protection and maintenance of excess and surplus real property are in §101-47.4913. The holding agency shall be responsible for complying with the requirements of the National Oil and Hazardous Substances Pollution Contingency Plan and initiating or cooperating with others in the actions prescribed for the prevention, containment, or remedy of hazardous conditions.

[49 FR 1348, Jan. 11, 1984]

§ 101-47.402-2 Expense of protection and maintenance.

(a) The holding agency shall be responsible for the expense of protection and maintenance of such property pending transfer or disposal for not more than 12 months, plus the period to the first day of the succeeding quarter of the fiscal year after the date that the property is available for immediate disposition. If the holding agency requests deferral of the disposal, continues to occupy the property beyond the excess date to the detriment of orderly disposal, or otherwise takes actions which result in a delay in the disposition, the period for which that agency is responsible for such expenses shall be extended by the period of delay. (See §101-47.202-9.)

(b) In the event the property is not transferred to a Federal agency or disposed of during the period mentioned

Federal Property Management Regulations

§ 101-47.501-3

in paragraph (a) of this section, the expense of protection and maintenance of such property from and after the expiration date of said period shall be either paid or reimbursed to the holding agency, subject to the limitations herein, which payment or reimbursement shall be in the discretion of the disposal agency. The maximum amount of protection and maintenance to be paid or reimbursed by the disposal agency will be specified in a written agreement between the holding agency and the disposal agency, but such payment or reimbursement is subject to the appropriations by Congress to the disposal agency of funds sufficient to make such payment or reimbursement. In accordance with the written agreement, the disposal agency and the holding agency will sign an obligational document only if and when Congress actually appropriates to the disposal agency, pursuant to its request, funds sufficient to pay or reimburse the holding agency for protection and maintenance expenses, as agreed. In the absence of a written agreement, the holding agency shall be responsible for all expenses of protection and maintenance, without any right of contribution or reimbursement from the disposal agency.

[49 FR 1348, Jan. 11, 1984]

§ 101-47.403 Assistance in disposition.

The holding agency is expected to cooperate with the disposal agency in showing the property to prospective transferees or purchasers. Unless extraordinary expenses are incurred in showing the property, the holding agency shall absorb the entire cost of such actions. (See § 101-47.304-5.)

[36 FR 3894, Mar. 2, 1971]

Subpart 101-47.5—Abandonment, Destruction, or Donation to Public Bodies

§ 101-47.500 Scope of subpart.

(a) This subpart prescribes the policies and methods governing the abandonment, destruction, or donation to the public bodies by Federal agencies of real property located within the States of the Union, the District of Columbia, the Commonwealth of Puerto

Rico, American Samoa, Guam, the Trust Territory of the Pacific Islands, and the Virgin Islands.

(b) The subpart does not apply to surplus property assigned for disposal to educational or public health institutions pursuant to section 203(k) of the Act.

[29 FR 16126, Dec. 3, 1964, as amended at 47 FR 4522, Feb. 1, 1982]

§ 101-47.501 General provisions of subpart.

§ 101-47.501-1 Definitions.

(a) *No commercial value* means real property, including related personal property, which has no reasonable prospect of being disposed of at a consideration.

(b) *Public body* means any State of the United States, the District of Columbia, the Commonwealth of Puerto Rico, the Virgin Islands, or any political subdivision, agency, or instrumentality of the foregoing.

§ 101-47.501-2 Authority for disposal.

Subject to the restrictions in § 101-47.502 and § 101-47.503, any Federal agency having control of real property which has no commercial value or of which the estimated cost of continued care and handling would exceed the estimated proceeds from its sale, is authorized:

(a) To abandon or destroy Government-owned improvements and related personal property located on privately owned land.

(b) To destroy Government-owned improvements and related personal property located on Government-owned land. Abandonment of such property is not authorized.

(c) To donate to public bodies any real property (land and/or improvements and related personal property), or interests therein, owned by the Government.

§ 101-47.501-3 Dangerous property.

No property which is dangerous to public health or safety shall be abandoned, destroyed, or donated to public bodies pursuant to this subpart without first rendering such property innocuous or providing adequate safeguards therefor.

§ 101-47.501-4

41 CFR Ch. 101 (7-1-01 Edition)

§ 101-47.501-4 Findings.

(a) No property shall be abandoned, destroyed, or donated by a Federal agency under §101-47.501-2, unless a duly authorized official of that agency finds, in writing, either that (1) such property has no commercial value, or (2) the estimated cost of its continued care and handling would exceed the estimated proceeds from its sale. Such finding shall not be made by any official directly accountable for the property covered thereby.

(b) Whenever all the property proposed to be disposed of hereunder by a Federal agency at any one location at any one time had an original cost (estimated if not known) of more than \$1,000, findings made under §101-47.501-4(a), shall be approved by a reviewing authority before any such disposal.

§ 101-47.502 Donations to public bodies.

§ 101-47.502-1 Cost limitations.

No improvements on land or related personal property having an original cost (estimated if not known) in excess of \$250,000 and no land, regardless of cost, shall be donated to public bodies without the prior concurrence of GSA. The request for such concurrence shall be made to the regional office of GSA for the region in which the property is located.

§ 101-47.502-2 Disposal costs.

Any public body receiving improvements on land or related personal property pursuant to this subpart shall pay the disposal costs incident to the donation, such as dismantling, removal, and the cleaning up of the premises.

§ 101-47.503 Abandonment and destruction.

§ 101-47.503-1 General.

(a) No improvements on land or related personal property shall be abandoned or destroyed by a Federal agency unless a duly authorized official of that agency finds, in writing, that donation of such property in accordance with the provisions of this subpart is not feasible. This finding shall be in addition to the finding prescribed in §101-47.501-4. If at any time prior to actual

abandonment or destruction the donation of the property pursuant to this subpart becomes feasible, such donation will be accomplished.

(b) No abandonment or destruction shall be made in a manner which is detrimental or dangerous to public health or safety or which will cause infringement of the rights of other persons.

(c) The concurrence of GSA shall be obtained prior to the abandonment or destruction of improvements on land or related personal property (1) which had an original cost (estimated if not known) of more than \$50,000, or (2) which are of permanent type construction, or (3) where their retention would enhance the value of the underlying land, if it were to be made available for sale or lease.

§ 101-47.503-2 Notice of proposed abandonment or destruction.

Except as provided in §101-47.503-3, improvements on land or related personal property shall not be abandoned or destroyed by a Federal agency until after public notice of such proposed abandonment or destruction. Such notice shall be given in the area in which the property is located, shall contain a general description of the property to be abandoned or destroyed, and shall include an offering of the property for sale. A copy of such notice shall be given to the regional office of GSA for the region in which the property is located.

§ 101-47.503-3 Abandonment or destruction without notice.

If (a) the property had an original cost (estimated if not known) of not more than \$1,000; or (b) its value is so low or the cost of its care and handling so great that its retention in order to post public notice is clearly not economical; or (c) immediate abandonment or destruction is required by considerations of health, safety, or security; or (d) the assigned mission of the agency might be jeopardized by the delay, and a finding with respect to paragraph (a), (b), (c), or (d) of this section, is made in writing by a duly authorized official of the Federal agency and approved by a reviewing authority, abandonment or destruction may be made without public notice. Such a

Federal Property Management Regulations

§ 101-47.603

finding shall be in addition to the findings prescribed in §§101-47.501-4 and 101-47.503-1(a).

Subpart 101-47.6—Delegations

§ 101-47.600 Scope of subpart.

This subpart sets forth the special delegations of authority granted by the Administrator of General Services to other agencies for the utilization and disposal of certain real property pursuant to the Act.

§ 101-47.601 Delegation to Department of Defense.

(a) Authority is delegated to the Secretary of Defense to determine that excess real property and related personal property under the control of the Department of Defense having a total estimated fair market value, including all the component units of the property, of less than \$15,000 as determined by the Department of Defense, is not required for the needs and responsibilities of Federal agencies; and thereafter to dispose of said property by means deemed advantageous to the United States.

(b) Prior to such determination and disposal, the Secretary of Defense shall take steps as may be appropriate to determine that the property is not required for the needs of any Federal agency.

(c) The authority conferred in this §101-47.601 shall be exercised in accordance with the Act and regulations issued pursuant thereto, except that the reporting of such property to GSA under subpart 101-47.2 shall not be required.

(d) The authority delegated in this §101-47.601 may be redelegated to any officer or employee of the Department of Defense.

[29 FR 16126, Dec. 3, 1964, as amended at 31 FR 16780, Dec. 31, 1966; 56 FR 56935, Nov. 7, 1991]

§ 101-47.602 Delegation to the Department of Agriculture.

(a) Authority is delegated to the Secretary of Agriculture to determine that excess real property and related personal property under the control of the Department of Agriculture having a total estimated fair market value, in-

cluding all the component units of the property, of less than \$15,000 as determined by the Department of Agriculture, is not required for the needs and responsibilities of Federal agencies; and thereafter to dispose of said property by means deemed advantageous to the United States.

(b) Prior to such determination and disposal, the Secretary of Agriculture shall take steps as may be appropriate to determine that the property is not required for the needs of any Federal agency.

(c) The authority conferred in this §101-47.602 shall be exercised in accordance with the Act and regulations issued pursuant thereto, except that the reporting of such property to GSA under subpart 101-47.2 shall not be required.

(d) The authority delegated in this §101-47.602 may be redelegated to any officer or employee of the Department of Agriculture.

[29 FR 16126, Dec. 3, 1964, as amended at 31 FR 16780, Dec. 31, 1966; 56 FR 56936, Nov. 7, 1991]

§ 101-47.603 Delegations to the Secretary of the Interior.

(a) Authority is delegated to the Secretary of the Interior to maintain custody and control of an accountability for those mineral resources which may be designated from time to time by the Administrator or his designee and which underlie Federal property currently utilized or excess or surplus to the Government's needs. Authority is also delegated to the Secretary to dispose of such mineral resources by lease and to administer any leases which are made.

(1) The Secretary may redelegate this authority to any officer, official, or employee of the Department of the Interior.

(2) Under this authority, the Secretary of the Interior, as head of the holding agency is responsible for the following: (i) Maintaining proper inventory records, and (ii) monitoring the minerals as necessary to ensure that no unauthorized mining or removal of the minerals occurs.

(3) Under this authority, the Secretary of the Interior, as head of the disposal agency, is responsible for the

following: (i) Securing, in accordance with §101-47.303-4, any appraisals deemed necessary by the Secretary; (ii) coordinating with all surface landowners, Federal or otherwise, so as not to unduly interfere with the surface use; (iii) ensuring that the lands which may be disturbed or damaged are restored after removal of the mineral deposits is completed; and (iv) notifying the Administrator when the disposal of all marketable mineral deposits has been completed.

(4) The Secretary of the Interior, as head of the disposal agency, is responsible for complying with the applicable environmental laws and regulations, including (i) the National Environmental Policy Act of 1969, as amended (42 U.S.C. 4321, *et seq.*) and the implementing regulations issued by the Council on Environmental Quality (40 CFR part 1500); (ii) section 106 of the National Historic Preservation Act of 1966 (16 U.S.C. 470f); and (iii) the Coastal Zone Management Act of 1972 (16 U.S.C. 1451, *et seq.*) and the Department of Commerce implementing regulations (15 CFR parts 923 and 930).

(5) The Secretary of the Interior will forward promptly to the Administrator copies of any agreements executed under this authority.

(6) The Secretary of the Interior will provide to the Administrator an annual accounting of the proceeds received from leases executed under this authority.

(b) Authority is delegated to the Secretary of the Interior to determine that excess real property and related personal property under his control having a total estimated fair market value, including all components of the property, of less than \$15,000 as determined by the Secretary, is not required for the needs and responsibilities of Federal agencies; and thereafter to dispose of the property by means most advantageous to the United States.

[48 FR 50893, Nov. 4, 1983, as amended at 56 FR 56936, Nov. 7, 1991]

§ 101-47.604 Delegation to the Department of the Interior, the Department of Health and Human Services, and the Department of Education.

(a) The Secretary of the Interior, the Secretary of Health and Human Services, and the Secretary of Education, are delegated authority to transfer and to retransfer to each other, upon request, any of the property of either agency which is being used and will continue to be used in the administration of any functions relating to the Indians. The term *property*, as used in this §101-47.604, includes real property and such personal property as the Secretary making the transfer or retransfer determines to be related personal property.

(b) This authority shall be exercised only in connection with property which the Secretary transferring or retransferring such property determines:

(1) Comprises a functional unit;

(2) Is located within the United States; and

(3) Has an acquisition cost of \$100,000 or less: *Provided, however*, That the transfer or retransfer shall not include property situated in any area which is recognized as an urban area or place for the purpose of the most recent decennial census.

(c) No screening of the property as required by the regulations in this part 101-47 need be conducted, it having been determined that such screening among Federal agencies would accomplish no useful purpose since the property which is subject to transfer or retransfer hereunder will continue to be used in the administration of any functions relating to the Indians.

(d) Any such transfer or retransfer of a specific property shall be without reimbursement except:

(1) Where funds programmed and appropriated for acquisition of the property are available to the Secretary requesting the transfer or retransfer; or

(2) Whenever reimbursement at fair value is required by subpart 101-47.2.

(e) Where funds were not programed and appropriated for acquisition of the

Federal Property Management Regulations

§ 101-47.800

property, the Secretary requesting the transfer or retransfer shall so certify. Any determination necessary to carry out the authority contained in this §101-47.604 which otherwise would be required under this part to be made by GSA shall be made by the Secretary transferring or retransferring the property.

(f) The authority conferred in this §101-47.604 shall be exercised in accordance with such other provisions of the regulations of GSA issued pursuant to the Act as may be applicable.

(g) The Secretary of the Interior, the Secretary of Health and Human Services, and the Secretary of Education, are authorized to redelegate any of the authority contained in this §101-47.604 to any officers or employees of their respective departments.

[29 FR 16126, Dec. 3, 1964, as amended at 56 FR 56936, Nov. 7, 1991]

Subpart 101-47.7—Conditional Gifts of Real Property To Further the Defense Effort

§101-47.700 Scope of subpart.

This subpart provides for acceptance or rejection on behalf of the United States of any gift of real property offered on condition that it be used for a particular defense purpose and for subsequent disposition of such property (Act of July 27, 1954, (50 U.S.C. 1151-1156)).

[40 FR 12079, Mar. 17, 1975]

§101-47.701 Offers and acceptance of conditional gifts.

(a) Any agency receiving an offer of a conditional gift of real property for a particular defense purpose within the purview of the Act of July 27, 1954, shall notify the appropriate regional office of GSA and shall submit a recommendation as to acceptance or rejection of the gift.

(b) Prior to such notification, the receiving agency shall acknowledge receipt of the offer and advise the donor of its referral to the GSA regional office, but should not indicate acceptance or rejection of the gift on behalf of the United States. A copy of the acknowledgment shall accompany the

notification and recommendation to the regional office.

(c) When the gift is determined to be acceptable and it can be accepted and used in the form in which offered, it will be transferred without reimbursement to an agency designated by GSA for use for the particular purpose for which it was donated.

(d) If the gift is one which GSA determines may and should be converted to money, the funds, after conversion, will be deposited with the Treasury Department for transfer to an appropriate account which will best effectuate the intent of the donor, in accordance with Treasury Department procedures.

§101-47.702 Consultation with agencies.

Such conditional gifts of real property will be accepted or rejected on behalf of the United States or transferred to an agency by GSA, only after consultation with the interested agencies.

§101-47.703 Advice of disposition.

GSA will advise the donor and the agencies concerned of the action taken with respect to acceptance or rejection of the conditional gift and of its final disposition.

§101-47.704 Acceptance of gifts under other laws.

Nothing in this subpart 101-47.7 shall be construed as applicable to the acceptance of gifts under the provisions of other laws.

Subpart 101-47.8—Identification of Unneeded Federal Real Property

§101-47.800 Scope of subpart.

This subpart is designed to implement, in part, section 2 of Executive Order 12512, which provides, in part, that the Administrator of General Services shall provide Governmentwide policy, oversight and guidance for Federal real property management. The Administrator of General Services shall issue standards, procedures, and guidelines for the conduct of surveys of real property holdings of Executive agencies on a continuing basis to identify properties which are not utilized, are underutilized, or are not being put

to their optimum use; and make reports describing any property or portion thereof which has not been reported excess to the requirements of the holding agency and which, in the judgment of the Administrator, is not utilized, is underutilized, or is not being put to optimum use, and which he recommends should be reported as excess property. The provisions of this subpart are presently limited to fee-owned properties and supporting leaseholds and lesser interests located within the States of the United States, the District of Columbia, the Commonwealth of Puerto Rico, American Samoa, Guam, the Trust Territory of the Pacific Islands, and the Virgin Islands. The scope of this subpart may be enlarged at a later date to include real property in additional geographical areas and other interests in real property.

[51 FR 193, Jan. 3, 1986]

§ 101-47.801 Standards.

Each executive agency shall use the following standards in identifying unneeded Federal property.

(a) *Definitions*—(1) *Not utilized*. “Not utilized” means an entire property or portion thereof, with or without improvements, not occupied for current program purposes of the accountable executive agency, or occupied in caretaker status only.

(2) *Underutilized*. “Underutilized” means an entire property or portion thereof, with or without improvements:

(i) Which is used only at irregular periods or intermittently by the accountable executive agency for current program purposes of that agency; or

(ii) Which is used for current program purposes that can be satisfied with only a portion of the property.

(3) *Not being put to optimum use*. “Not being put to optimum use” means an entire property or portion thereof, with or without improvements, which:

(i) Even though utilized for current program purposes of the accountable executive agency is of such nature or value, or is in such a location that it could be utilized for a different significantly higher and better purpose; or

(ii) The costs of occupying are substantially higher than would be appli-

cable for other suitable properties that could be made available to the accountable executive agency through transfer, purchase, or lease with total net savings to the Government after consideration of property values as well as costs of moving, occupancy, efficiency of operations, environmental effects, regional planning, and employee morale.

(b) *Guidelines*. The following general guidelines shall be considered by each executive agency in its annual review (see § 101-47.802):

(1) Is the property being put to its highest and best use?

(i) Consider such aspects as surrounding neighborhood, zoning, and other environmental factors;

(ii) Is present use compatible with State, regional, or local development plans and programs?

(iii) Consider whether Federal use of the property would be justified if rental charge equivalent to commercial rates were added to the program costs for the function it is serving.

(2) Are operating and maintenance costs excessive compared with those of other similar facilities?

(3) Will contemplated program changes alter property requirements?

(4) Is all of the property essential for program requirements?

(5) Will local zoning provide sufficient protection for necessary buffer zones if a portion of the property is released?

(6) Are buffer zones kept to a minimum?

(7) Is the present property inadequate for approved future programs?

(8) Can net savings to the Nation be realized through relocation considering property prices or rentals, costs of moving, occupancy, and increase in efficiency of operations?

(9) Have developments on adjoining nonfederally owned land or public access or road rights-of-way granted across the Government-owned land rendered the property or any portion thereof unsuitable or unnecessary for program requirements?

(10) If Federal employees are housed in Government-owned residential property, is the local market willing to acquire Government-owned housing or can it provide the necessary housing

Federal Property Management Regulations

§ 101-47.802

and other related services that will permit the Government-owned housing area to be released? (Provide statistical data on cost and availability of housing on the local market.)

(11) Can the land be disposed of and program requirements satisfied through reserving rights and interests to the Government in the property if it is released?

(12) Is a portion of any property being retained primarily because the present boundaries are marked by the existence of fences, hedges, roads, and utility systems?

(13) Is any land being retained merely because it is considered undesirable property due to topographical features or to encumbrances for rights-of-way or because it is believed to be not disposable?

(14) Is land being retained merely because it is landlocked?

(15) Is there land or space in Government-owned buildings that can be made available for utilization by others within or outside Government on a temporary basis?

[35 FR 5261, Mar. 28, 1970, as amended at 37 FR 5030, Mar. 9, 1972; 40 FR 12079, Mar. 17, 1975]

§ 101-47.802 Procedures.

(a) *Executive agency annual review.* Each executive agency shall make an annual review of its property holdings.

(1) In making such annual reviews, each executive agency shall use the standards set forth in §101-47.801 in identifying property that is not utilized, is underutilized, or is not being put to its optimum use.

(2) A written record of the review of each individual facility shall be prepared. The written review record shall contain comments relative to each of the above guidelines and an overall map of the facility showing property boundaries, major land uses, improvements, safety zones, proposed uses, and regulations or other authorizations that sanction the requirement for and usage made of or proposed for individual parcels of the property. A copy of the review record shall be made available to GSA upon request or to the GSA survey representative at the time of the survey of each individual facility.

(3) Each executive agency shall, as a result of its annual review, determine, in its opinion, whether any portion of its property is not utilized, is underutilized, or is not being put to optimum use. With regard to each property, the following actions shall be taken:

(i) When the property or a portion thereof is determined to be not utilized, the executive agency shall:

(A) Initiate action to release the property; or

(B) Hold for a foreseeable future program use upon determination by the head of the executive agency. Such determination shall be fully and completely documented and the determination and documentation kept available for GSA review (see §101-47.802(b)(3)(ii)(B)). If property of this type which is being held for future use can be made available for temporary use by others, the executive agency shall notify the appropriate regional office of GSA before any permit or license for use is issued to another Federal agency or before any out-lease is granted by the executive agency. GSA will advise the executive agency whether the property should be permitted to another Federal agency for temporary use and will advise the executive agency the name of the Federal agency to whom the permit shall be granted.

(ii) When the property is determined to be underutilized, the executive agency shall:

(A) Limit the existing program to a reduced area and initiate action to release the remainder; or

(B) Shift present use imposed on the property to another property so that release action may be initiated for the property under review.

(iii) When, based on an indepth study and evaluation, it is determined that the property is not being put to its optimum use, the executive agency shall relocate the current program whenever a suitable alternate site, necessary funding, and legislative authority are available to accomplish that purpose. When the site, funding, or legislative authority are not available, a special report shall be made to the appropriate regional office of GSA for its consideration in obtaining possible assistance in accomplishing relocation.

(b) *GSA Survey*. Pursuant to section 2 of Executive Order 12512, GSA will conduct, on a continuing basis, surveys of real property holdings of all Executive agencies to identify properties which, in the judgment of the Administrator of General Services, are not utilized, are underutilized, or are not being put to their optimum use.

(1) GSA surveys of the real property holdings of executive agencies will be conducted by officials of the GSA Central Office and/or regional offices of GSA for the property within the geographical area of each region.

(i) The head of the field office of the agency having accountability for the facility will be notified in advance of a scheduled GSA survey and furnished at that time with copies of these regulations.

(ii) The head of that field office shall arrange for an appropriate official of the executive agency having necessary authority, and who is sufficiently knowledgeable concerning the property and current and future program uses of the property, to be available to assist the GSA representative in his survey.

(2) [Reserved]

(3) To facilitate the GSA survey, executive agencies shall:

(i) Cooperate fully with GSA in its conduct of the surveys; and

(ii) Make available to the GSA survey representative records and information pertinent to the description and to the current and proposed use of the property such as:

(A) Brief description of facilities (number of acres, buildings, and supporting facilities);

(B) The most recent utilization report or analysis made of the property including the written record of the annual review made by the agency, pursuant to §101-47.802(a), together with any supporting documents;

(C) Detail maps which show property boundaries, major land uses, improvements, safety zones, proposed uses, and regulations or other authorizations that sanction the usage made or proposed for individual parcels or the entire property; drawings; and layout plans.

(4) Upon receipt of notification of the pending GSA survey, the executive agency shall initiate action imme-

diately to provide the GSA representative with an escort into classified or sensitive areas or to inform that representative of steps that must be taken to obtain necessary special security clearances or both.

(5) Upon completion of the field work for the survey:

(i) The GSA representative will so inform the executive agency designated pursuant to 101-47.802(b)(1). To avoid any possibility of misunderstanding or premature publicity, conclusions and recommendations will not be discussed with this official. However, survey teams should discuss the facts they have obtained with local officials at the end of the survey to ensure that all information necessary to conduct a complete survey is obtained. The GSA representative will evaluate and incorporate the results of the field work into a survey report and forward the survey report to the GSA Central Office.

(ii) The GSA Central Office will notify the head of the Executive agency or his designee, in writing, of the survey findings and/or recommendations. A copy of the survey report will be enclosed when a recommendation is made that some or all of the real property should be reported excess, and the comments of the Executive agency will be requested thereon. The Executive agency will be afforded 45 calendar days from the date of the notice in which to submit such comments. If the case is resolved, GSA Central Office will notify the head of the Executive agency or his designee, in writing, of the resolution, and the case will be completed at such time as the agency completes all resolved excess and/or disposal actions. The agency will be afforded a period of 90 calendar days from the date of the notice to complete such actions.

(iii)-(iv) [Reserved]

(v) If the case is not resolved, the GSA Central Office will request assistance of the Executive Office of the President to obtain resolution.

[35 FR 5261, Mar. 28, 1970, as amended at 36 FR 7215, Apr. 16, 1971; 37 FR 5030, Mar. 9, 1972; 42 FR 40698, Aug. 11, 1977; 48 FR 25200, June 6, 1983; 51 FR 194, Jan. 3, 1986]

Subpart 101-47.9—Use of Federal Real Property To Assist the Homeless

SOURCE: 56 FR 23794, 23795, May 24, 1991, unless otherwise noted.

§ 101-47.901 Definitions.

Applicant means any representative of the homeless which has submitted an application to the Department of Health and Human Services to obtain use of a particular suitable property to assist the homeless.

Checklist or property checklist means the form developed by HUD for use by landholding agencies to report the information to be used by HUD in making determinations of suitability.

Classification means a property's designation as unutilized, underutilized, excess, or surplus.

Day means one calendar day including weekends and holidays.

Eligible organization means a State, unit of local government or a private non-profit organization which provides assistance to the homeless, and which is authorized by its charter or by State law to enter into an agreement with the Federal government for use of real property for the purposes of this subpart. Representatives of the homeless interested in receiving a deed for a particular piece of surplus Federal property must be section 501(c)(3) tax exempt.

Excess property means any property under the control of any Federal executive agency that is not required for the agency's needs or the discharge of its responsibilities, as determined by the head of the agency pursuant to 40 U.S.C. 483.

GSA means the General Services Administration.

HHS means the Department of Health and Human Services.

Homeless means:

(1) An individual or family that lacks a fixed, regular, and adequate nighttime residence; and

(2) An individual or family that has a primary nighttime residence that is:

(i) A supervised publicly or privately operated shelter designed to provide temporary living accommodations (including welfare hotels, congregate

shelters, and transitional housing for the mentally ill);

(ii) An institution that provides a temporary residence for individuals intended to be institutionalized; or

(iii) A public or private place not designed for, or ordinarily used as, a regular sleeping accommodation for human beings. This term does not include any individual imprisoned or otherwise detained under an Act of the Congress or a State law.

HUD means the Department of Housing and Urban Development.

ICH means the Interagency Council on the Homeless.

Landholding agency means a Federal department or agency with statutory authority to control real property.

Lease means an agreement between either the Department of Health and Human Services for surplus property, or landholding agencies in the case of non-excess properties or properties subject to the Base Closure and Realignment Act (Public Law 100-526; 10 U.S.C. 2687), and the applicant, giving rise to the relationship of lessor and lessee for the use of Federal real property for a term of at least one year under the conditions set forth in the lease document.

Non-profit organization means an organization no part of the net earnings of which inures to the benefit of any member, founder, contributor, or individual; that has a voluntary board; that has an accounting system or has designated an entity that will maintain a functioning accounting system for the organization in accordance with generally accepted accounting procedures; and that practices non-discrimination in the provision of assistance.

Permit means a license granted by a landholding agency to use unutilized or underutilized property for a specific amount of time under terms and conditions determined by the landholding agency.

Property means real property consisting of vacant land or buildings, or a portion thereof, that is excess, surplus, or designated as unutilized or underutilized in surveys by the heads of landholding agencies conducted pursuant to

§ 101-47.902

section 202(b)(2) of the Federal Property and Administrative Services Act of 1949 (40 U.S.C. 483(b)(2).)

Regional Homeless Coordinator means a regional coordinator of the Interagency Council on the Homeless.

Representative of the Homeless means a State or local government agency, or private nonprofit organization which provides, or proposes to provide, services to the homeless.

Screen means the process by which GSA surveys Federal agencies, or State, local and non-profit entities, to determine if any such entity has an interest in using excess Federal property to carry out a particular agency mission or a specific public use.

State Homeless Coordinator means a state contact person designated by a state to receive and disseminate information and communications received from the Interagency Council on the Homeless in accordance with section 210(a) of the Stewart B. McKinney Act of 1987, as amended.

Suitable property means that HUD has determined that a particular property satisfies the criteria listed in §101-47.906.

Surplus property means any excess real property not required by any Federal landholding agency for its needs or the discharge of its responsibilities, as determined by the Administrator of GSA.

Underutilized means an entire property or portion thereof, with or without improvements which is used only at irregular periods or intermittently by the accountable landholding agency for current program purposes of that agency, or which is used for current program purposes that can be satisfied with only a portion of the property.

Unsuitable property means that HUD has determined that a particular property does not satisfy the criteria in §101-47.906.

Unutilized property means an entire property or portion thereof, with or without improvements, not occupied for current program purposes for the accountable executive agency or occupied in caretaker status only.

§ 101-47.902 Applicability.

(a) This part applies to Federal real property which has been designated by

41 CFR Ch. 101 (7-1-01 Edition)

Federal landholding agencies as unutilized, underutilized, excess or surplus and is therefore subject to the provisions of title V of the McKinney Act (42 U.S.C. 11411).

(b) The following categories of properties are not subject to this subpart (regardless of whether they may be unutilized or underutilized).

(1) Machinery and equipment.

(2) Government-owned, contractor-operated machinery, equipment, land, and other facilities reported excess for sale only to the using contractor and subject to a continuing military requirement.

(3) Properties subject to special legislation directing a particular action.

(4) Properties subject to a Court Order.

(5) Property not subject to survey requirements of Executive Order 12512 (April 29, 1985).

(6) Mineral rights interests.

(7) Air Space interests.

(8) Indian Reservation land subject to section 202(a)(2) of the Federal Property and Administrative Service Act of 1949, as amended.

(9) Property interests subject to reversion.

(10) Easements.

(11) Property purchased in whole or in part with Federal funds if title to the property is not held by a Federal landholding agency as defined in this part.

§ 101-47.903 Collecting the information.

(a) *Canvass of landholding agencies.* On a quarterly basis, HUD will canvass landholding agencies to collect information about property described as unutilized, underutilized, excess, or surplus, in surveys conducted by the agencies under section 202 of the Federal Property and Administrative Services Act (40 U.S.C. 483), Executive Order 12512, and 41 CFR part 101-47.800. Each canvass will collect information on properties not previously reported and about property reported previously the status or classification of which has changed or for which any of the information reported on the property checklist has changed.

(1) HUD will request descriptive information on properties sufficient to

make a reasonable determination, under the criteria described below, of the suitability of a property for use as a facility to assist the homeless.

(2) HUD will direct landholding agencies to respond to requests for information within 25 days of receipt of such requests.

(b) *Agency annual report.* By December 31 of each year, each landholding agency must notify HUD regarding the current availability status and classification of each property controlled by the agency that:

(1) Was included in a list of suitable properties published that year by HUD, and

(2) Remains available for application for use to assist the homeless, or has become available for application during that year.

(c) *GSA inventory.* HUD will collect information, in the same manner as described in paragraph (a) of this section, from GSA regarding property that is in GSA's current inventory of excess or surplus property.

(d) *Change in status.* If the information provided on the property checklist changes subsequent to HUD's determination of suitability, and the property remains unutilized, underutilized, excess or surplus, the landholding agency shall submit a revised property checklist in response to the next quarterly canvass. HUD will make a new determination of suitability and, if it differs from the previous determination, republish the property information in the FEDERAL REGISTER. For example, property determined unsuitable for national security concerns may no longer be subject to security restrictions, or property determined suitable may subsequently be found to be contaminated.

EFFECTIVE DATE NOTE: Section 101-47.903 will not become effective until approved by the District Court for the District of Columbia pending further proceedings in the case *National Law Center on Homelessness and Poverty v. Dept. of Veterans Affairs*, No. 88-2503-OG (Dec. 12, 1988). (See 56 FR 23789, 23794 and, 23795, May 24, 1991. The General Services Administration will publish a document in the FEDERAL REGISTER at a later date, announcing the effective date.

§ 101-47.904 Suitability determination.

(a) *Suitability determination.* Within 30 days after the receipt of information from landholding agencies regarding properties which were reported pursuant to the canvass described in §101-47.903(a), HUD will determine, under criteria set forth in §101-47.906, which properties are suitable for use as facilities to assist the homeless and report its determination to the landholding agency. Properties that are under lease, contract, license, or agreement by which a Federal agency retains a real property interest or which are scheduled to become unutilized or underutilized will be reviewed for suitability no earlier than six months prior to the expected date when the property will become unutilized or underutilized, except that properties subject to the Base Closure and Realignment Act may be reviewed up to eighteen months prior to the expected date when the property will become unutilized or underutilized.

(b) *Scope of suitability.* HUD will determine the suitability of a property for use as a facility to assist the homeless without regard to any particular use.

(c) *Environmental information.* HUD will evaluate the environmental information contained in property checklists forwarded to HUD by the landholding agencies solely for the purpose of determining suitability of properties under the criteria in §101-47.906.

(d) *Written record of suitability determination.* HUD will assign an identification number to each property reviewed for suitability. HUD will maintain a written public record of the following:

(1) The suitability determination for a particular piece of property, and the reasons for that determination; and

(2) The landholding agency's response to the determination pursuant to the requirements of §101-47.907(a).

(e) *Property determined unsuitable.* Property that is reviewed by HUD under this section and that is determined unsuitable for use to assist the homeless may not be made available for any other purpose for 20 days after publication in the FEDERAL REGISTER of a Notice of unsuitability to allow for

§ 101-47.905

review of the determination at the request of a representative of the homeless.

(f) *Procedures for appealing unsuitability determinations.* (1) To request review of a determination of unsuitability, a representative of the homeless must contact HUD within 20 days of publication of notice in the FEDERAL REGISTER that a property is unsuitable. Requests may be submitted to HUD in writing or by calling 1-800-927-7588 (Toll Free). Written requests must be received no later than 20 days after notice of unsuitability is published in the FEDERAL REGISTER.

(2) Requests for review of a determination of unsuitability may be made only by representatives of the homeless, as defined in §101-47.901.

(3) The request for review must specify the grounds on which it is based, i.e., that HUD has improperly applied the criteria or that HUD has relied on incorrect or incomplete information in making the determination (e.g., that property is in a floodplain but not in a floodway).

(4) Upon receipt of a request to review a determination of unsuitability, HUD will notify the landholding agency that such a request has been made, request that the agency respond with any information pertinent to the review, and advise the agency that it should refrain from initiating disposal procedures until HUD has completed its reconsideration regarding unsuitability.

(i) HUD will act on all requests for review within 30 days of receipt of the landholding agency's response and will notify the representative of the homeless and the landholding agency in writing of its decision.

(ii) If a property is determined suitable as a result of the review, HUD will request the landholding agency's determination of availability pursuant to §101-47.907(a), upon receipt of which HUD will promptly publish the determination in the FEDERAL REGISTER. If the determination of unsuitability stands, HUD will inform the representative of the homeless of its decision.

41 CFR Ch. 101 (7-1-01 Edition)

§ 101-47.905 Real property reported excess to GSA.

(a) Each landholding agency must submit a report to GSA of properties it determines excess. Each landholding agency must also provide a copy of HUD's suitability determination, if any, including HUD's identification number for the property.

(b) If a landholding agency reports a property to GSA which has been reviewed by HUD for homeless assistance suitability and HUD determined the property suitable, GSA will screen the property pursuant to §101-47.905(g) and will advise HUD of the availability of the property for use by the homeless as provided in §101-47.905(e). In lieu of the above, GSA may submit a new checklist to HUD and follow the procedures in §101-47.905(c) through §101-47.905(g).

(c) If a landholding agency reports a property to GSA which has not been reviewed by HUD for homeless assistance suitability, GSA will complete a property checklist, based on information provided by the landholding agency, and will forward this checklist to HUD for a suitability determination. This checklist will reflect any change in classification, i.e., from unutilized or underutilized to excess.

(d) Within 30 days after GSA's submission, HUD will advise GSA of the suitability determination.

(e) When GSA receives a letter from HUD listing suitable excess properties in GSA's inventory, GSA will transmit to HUD within 45 days a response which includes the following for each identified property:

(1) A statement that there is no other compelling Federal need for the property, and therefore, the property will be determined surplus; or

(2) A statement that there is further and compelling Federal need for the property (including a full explanation of such need) and that, therefore, the property is not presently available for use to assist the homeless.

(f) When an excess property is determined suitable and available and notice is published in the FEDERAL REGISTER, GSA will concurrently notify HHS, HUD, State and local government units, known homeless assistance providers that have expressed interest in

Federal Property Management Regulations

§ 101-47.907

the particular property, and other organizations, as appropriate, concerning suitable properties.

(g) Upon submission of a Report of Excess to GSA, GSA may screen the property for Federal use. In addition, GSA may screen State and local governmental units and eligible nonprofit organizations to determine interest in the property in accordance with current regulations. (See 41 CFR 101-47.203-5, 101-47.204-1 and 101-47.303-2.)

(h) The landholding agency will retain custody and accountability and will protect and maintain any property which is reported excess to GSA as provided in 41 CFR 101-47.402.

§ 101-47.906 Suitability criteria.

(a) All properties, buildings and land will be determined suitable unless a property's characteristics include one or more of the following conditions:

(1) *National security concerns.* A property located in an area to which the general public is denied access in the interest of national security (e.g., where a special pass or security clearance is a condition of entry to the property) will be determined unsuitable. Where alternative access can be provided for the public without compromising national security, the property will not be determined unsuitable on this basis.

(2) *Property containing flammable or explosive materials.* A property located within 2000 feet of an industrial, commercial or Federal facility handling flammable or explosive material (excluding underground storage) will be determined unsuitable. Above ground containers with a capacity of 100 gallons or less, or larger containers which provide the heating or power source for the property, and which meet local safety, operation, and permitting standards, will not affect whether a particular property is determined suitable or unsuitable. Underground storage, gasoline stations and tank trucks are not included in this category and their presence will not be the basis of an unsuitability determination unless there is evidence of a threat to personal safety as provided in paragraph (a)(5) of this section.

(3) *Runway clear zone and military airfield clear zone.* A property located

within an airport runway clear zone or military airfield clear zone will be determined unsuitable.

(4) *Floodway.* A property located in the floodway of a 100 year floodplain will be determined unsuitable. If the floodway has been contained or corrected, or if only an incidental portion of the property not affecting the use of the remainder of the property is in the floodway, the property will not be determined unsuitable.

(5) *Documented deficiencies.* A property with a documented and extensive condition(s) that represents a clear threat to personal physical safety will be determined unsuitable. Such conditions may include, but are not limited to, contamination, structural damage or extensive deterioration, friable asbestos, PCB's, or natural hazardous substances such as radon, periodic flooding, sinkholes or earth slides.

(6) *Inaccessible.* A property that is inaccessible will be determined unsuitable. An inaccessible property is one that is not accessible by road (including property on small off-shore islands) or is land locked (e.g., can be reached only by crossing private property and there is no established right or means of entry).

§ 101-47.907 Determination of availability.

(a) Within 45 days after receipt of a letter from HUD pursuant to §101-47.904(a), each landholding agency must transmit to HUD a statement of one of the following:

(1) In the case of unutilized or underutilized property:

(i) An intention to declare the property excess,

(ii) An intention to make the property available for use to assist the homeless, or

(iii) The reasons why the property cannot be declared excess or made available for use to assist the homeless. The reasons given must be different than those listed as suitability criteria in §101-47.906.

(2) In the case of excess property which had previously been reported to GSA:

(i) A statement that there is no compelling Federal need for the property,

§ 101-47.908

and that, therefore, the property will be determined surplus; or

(ii) A statement that there is a further and compelling Federal need for the property (including a full explanation of such need) and that, therefore, the property is not presently available for use to assist the homeless.

§ 101-47.908 Public notice of determination.

(a) No later than 15 days after the last 45 day period has elapsed for receiving responses from the landholding agencies regarding availability, HUD will publish in the FEDERAL REGISTER a list of all properties reviewed, including a description of the property, its address, and classification. The following designations will be made:

- (1) Properties that are suitable and available.
- (2) Properties that are suitable and unavailable.
- (3) Properties that are suitable and to be declared excess.
- (4) Properties that are unsuitable.

(b) Information about specific properties can be obtained by contacting HUD at the following toll free number, 1-800-927-7588.

(c) HUD will transmit to the ICH a copy of the list of all properties published in the FEDERAL REGISTER. The ICH will immediately distribute to all state and regional homeless coordinators area-relevant portions of the list. The ICH will encourage the state and regional homeless coordinators to disseminate this information widely.

(d) No later than February 15 of each year, HUD shall publish in the FEDERAL REGISTER a list of all properties reported pursuant to § 101-47.903(b).

(e) HUD shall publish an annual list of properties determined suitable but which agencies reported unavailable including the reasons such properties are not available.

(f) Copies of the lists published in the FEDERAL REGISTER will be available for review by the public in the HUD headquarters building library (room 8141); area-relevant portions of the lists will be available in the HUD regional offices and in major field offices.

41 CFR Ch. 101 (7-1-01 Edition)

§ 101-47.909 Application process.

(OMB approval number 09370191)

(a) *Holding period.* (1) Properties published as available for application for use to assist the homeless shall not be available for any other purpose for a period of 60 days beginning on the date of publication. Any representative of the homeless interested in any underutilized, unutilized, excess or surplus Federal property for use as a facility to assist the homeless must send to HHS a written expression of interest in that property within 60 days after the property has been published in the FEDERAL REGISTER.

(2) If a written expression of interest to apply for suitable property for use to assist the homeless is received by HHS within the 60 day holding period, such property may not be made available for any other purpose until the date HHS or the appropriate landholding agency has completed action on the application submitted pursuant to that expression of interest.

(3) The expression of interest should identify the specific property, briefly describe the proposed use, include the name of the organization, and indicate whether it is a public body or a private non-profit organization. The expression of interest must be sent to the Division of Health Facilities Planning (DHFP) of the Department of Health and Human Services at the following address:

Director, Division of Health Facilities Planning, Public Health Service, room 17A-10, Parklawn Building, 5600 Fishers Lane, Rockville, Maryland 20857.

HHS will notify the landholding agency (for unutilized and underutilized properties) or GSA (for excess and surplus properties) when an expression of interest has been received for a particular property.

(4) An expression of interest may be sent to HHS any time after the 60 day holding period has expired. In such a case, an application submitted pursuant to this expression of interest may be approved for use by the homeless if:

- (i) No application or written expression of interest has been made under any law for use of the property for any purpose; and

(ii) In the case of excess or surplus property, GSA has not received a bona fide offer to purchase that property or advertised for the sale of the property by public auction.

(b) *Application requirements.* Upon receipt of an expression of interest, DHFP will send an application packet to the interested entity. The application packet requires the applicant to provide certain information, including the following—

(1) *Description of the applicant organization.* The applicant must document that it satisfies the definition of a “representative of the homeless,” as specified in §101-47.901 of this subpart. The applicant must document its authority to hold real property. Private non-profit organizations applying for deeds must document that they are section 501(c)(3) tax-exempt.

(2) *Description of the property desired.* The applicant must describe the property desired and indicate that any modifications made to the property will conform to local use restrictions except for local zoning regulations.

(3) *Description of the proposed program.* The applicant must fully describe the proposed program and demonstrate how the program will address the needs of the homeless population to be assisted. The applicant must fully describe what modifications will be made to the property before the program becomes operational.

(4) *Ability to finance and operate the proposed program.* The applicant must specifically describe all anticipated costs and sources of funding for the proposed program. The applicant must indicate that it can assume care, custody, and maintenance of the property and that it has the necessary funds or the ability to obtain such funds to carry out the approved program of use for the property.

(5) *Compliance with non-discrimination requirements.* Each applicant and lessee under this part must certify in writing that it will comply with the requirements of the Fair Housing Act (42 U.S.C. 3601-3619) and implementing regulations; and as applicable, Executive Order 11063 (Equal Opportunity in Housing) and implementing regulations; title VI of the Civil Rights Act of 1964 (42 U.S.C. 2000d to d-4) (Non-

discrimination in Federally Assisted Programs) and implementing regulations; the prohibitions against discrimination on the basis of age under the Age Discrimination Act of 1975 (42 U.S.C. 6101-6107) and implementing regulations; and the prohibitions against otherwise qualified individuals with handicaps under section 504 of the Rehabilitation Act of 1973 (29 U.S.C. 794) and implementing regulations. The applicant must state that it will not discriminate on the basis of race, color, national origin, religion, sex, age, familial status, or handicap in the use of the property, and will maintain the required records to demonstrate compliance with Federal laws.

(6) *Insurance.* The applicant must certify that it will insure the property against loss, damage, or destruction in accordance with the requirements of 45 CFR 12.9.

(7) *Historic preservation.* Where applicable, the applicant must provide information that will enable HHS to comply with Federal historic preservation requirements.

(8) *Environmental information.* The applicant must provide sufficient information to allow HHS to analyze the potential impact of the applicant’s proposal on the environment, in accordance with the instructions provided with the application packet. HHS will assist applicants in obtaining any pertinent environmental information in the possession of HUD, GSA, or the landholding agency.

(9) *Local government notification.* The applicant must indicate that it has informed the applicable unit of general local government responsible for providing sewer, water, police, and fire services, in writing of its proposed program.

(10) *Zoning and local use restrictions.* The applicant must indicate that it will comply with all local use restrictions, including local building code requirements. Any applicant which applies for a lease or permit for a particular property is not required to comply with local zoning requirements. Any applicant applying for a deed of a particular property, pursuant to §101-47.90 9(b)(3), must comply with local zoning requirements, as specified in 45 CFR part 12.

(c) *Scope of evaluations.* Due to the short time frame imposed for evaluating applications, HHS' evaluation will, generally, be limited to the information contained in the application.

(d) *Deadline.* Completed applications must be received by DHFP, at the above address, within 90 days after an expression of interest is received from a particular applicant for that property. Upon written request from the applicant, HHS may grant extensions, provided that the appropriate landholding agency concurs with the extension. Because each applicant will have a different deadline based on the date the applicant submitted an expression of interest, applicants should contact the individual landholding agency to confirm that a particular property remains available prior to submitting an application.

(e) *Evaluations.* (1) Upon receipt of an application, HHS will review it for completeness, and, if incomplete, may return it or ask the applicant to furnish any missing or additional required information prior to final evaluation of the application.

(2) HHS will evaluate each completed application within 25 days of receipt and will promptly advise the applicant of its decision. Applications are evaluated on a first-come, first-serve basis. HHS will notify all organizations which have submitted expressions of interest for a particular property regarding whether the first application received for that property has been approved or disapproved. All applications will be reviewed on the basis of the following elements, which are listed in descending order of priority, except that paragraphs (e)(2)(iv) and (e)(2)(v) of this section are of equal importance.

(i) *Services offered.* The extent and range of proposed services, such as meals, shelter, job training, and counseling.

(ii) *Need.* The demand for the program and the degree to which the available property will be fully utilized.

(iii) *Implementation time.* The amount of time necessary for the proposed program to become operational.

(iv) *Experience.* Demonstrated prior success in operating similar programs and recommendations attesting to that

fact by Federal, State, and local authorities.

(v) *Financial ability.* The adequacy of funding that will likely be available to run the program fully and properly and to operate the facility.

(3) Additional evaluation factors may be added as deemed necessary by HHS. If additional factors are added, the application packet will be revised to include a description of these additional factors.

(4) If HHS receives one or more competing applications for a property within 5 days of the first application HHS will evaluate all completed applications simultaneously. HHS will rank approved applications based on the elements listed in §101-47.908(e)(2), and notify the landholding agency, or GSA, as appropriate, of the relative ranks.

§ 101-47.910 Action on approved applications.

(a) *Unutilized and underutilized properties.* (1) When HHS approves an application, it will so notify the applicant and forward a copy of the application to the landholding agency. The landholding agency will execute the lease, or permit document, as appropriate, in consultation with the applicant.

(2) The landholding agency maintains the discretion to decide the following:

(i) The length of time the property will be available. (Leases and permits will be for a period of at least one year unless the applicant requests a shorter term.)

(ii) Whether to grant use of the property via a lease or permit;

(iii) The terms and conditions of the lease or permit document.

(b) *Excess and surplus properties.* (1) When HHS approves an application, it will so notify the applicant and request that GSA assign the property to HHS for leasing. Upon receipt of the assignment, HHS will execute a lease in accordance with the procedures and requirements set out in 45 CFR part 12. In accordance with 41 CFR 101-47.402, custody and accountability of the property will remain throughout the lease term with the agency which initially reported the property as excess.

(2) Prior to assignment to HHS, GSA may consider other Federal uses and

other important national needs; however, in deciding the disposition of surplus real property, GSA will generally give priority of consideration to uses to assist the homeless. GSA may consider any competing request for the property made under section 203(k) of the Federal Property and Administrative Services Act of 1949 (40 U.S.C. 484(k)) that is so meritorious and compelling that it outweighs the needs of the homeless, and HHS may likewise consider any competing request made under subsection 203(k)(1) of that law.

(3) Whenever GSA or HHS decides in favor of a competing request over a request for property for homeless assistance use as provided in paragraph (b)(2) of this section, the agency making the decision will transmit to the appropriate committees of the Congress an explanatory statement which details the need satisfied by conveyance of the surplus property, and the reasons for determining that such need was so meritorious and compelling as to outweigh the needs of the homeless.

(4) *Deeds.* Surplus property may be conveyed to representatives of the homeless pursuant to section 203(k) of the Federal Property and Administrative Services Act of 1949 (40 U.S.C. 484(k)(1), and section 501(f) of the McKinney Act as amended, 42 U.S.C. 11411. Representatives of the homeless must complete the application packet pursuant to the requirements of § 101-47.909 of this part and in accordance with the requirements of 45 CFR part 12.

(c) *Completion of lease term and reversion of title.* Lessees and grantees will be responsible for the protection and maintenance of the property during the time that they possess the property. Upon termination of the lease term or reversion of title to the Federal government, the lessee or grantee will be responsible for removing any improvements made to the property and will be responsible for restoration of the property. If such improvements are not removed, they will become the property of the Federal government. GSA or the landholding agency, as appropriate, will assume responsibility for protection and maintenance of a property when the lease terminates or title reverts.

§ 101-47.911 Unsuitable properties.

The landholding agency will defer, for 20 days after the date that notice of a property is published in the FEDERAL REGISTER, action to dispose of properties determined unsuitable for homeless assistance. HUD will inform landholding agencies or GSA if appeal of an unsuitability determination is filed by a representative of the homeless pursuant to § 101-47.904(f)(4). HUD will advise the agency that it should refrain from initiating disposal procedures until HUD has completed its reconsideration process regarding unsuitability. Thereafter, or if no appeal has been filed after 20 days, GSA or the appropriate landholding agency may proceed with disposal action in accordance with applicable law.

§ 101-47.912 No applications approved.

(a) At the end of the 60 day holding period described in § 101-47.909(a), HHS will notify GSA, or the landholding agency, as appropriate, if an expression of interest has been received for a particular property. Where there is no expression of interest, GSA or the landholding agency, as appropriate, will proceed with disposal in accordance with applicable law.

(b) Upon advice from HHS that all applications have been disapproved, or if no completed applications or requests for extensions have been received by HHS within 90 days from the date of the last expression of interest, disposal may proceed in accordance with applicable law.

Subparts 101-47.10—101-47.48 [Reserved]

Subpart 101-47.49—Illustrations

§ 101-47.4900 Scope of subpart.

This subpart sets forth certain forms and illustrations referred to previously in this part. Agency field offices should obtain the GSA forms prescribed in this subpart by submitting their future requirements to their Washington headquarters office which will forward consolidated annual requirements to the General Services Administration (BRAAF), Washington, DC 20405. Standard forms should be obtained from the

§ 101-47.4901

nearest GSA supply distribution facility.

[40 FR 12080, Mar. 17, 1975]

§ 101-47.4901 [Reserved]

§ 101-47.4902 Standard Form 118, Report of Excess Real Property.

§ 101-47.4902-1 Standard Form 118a, Buildings, Structures, Utilities, and Miscellaneous Facilities.

§ 101-47.4902-2 Standard Form 118b, Land.

§ 101-47.4902-3 Standard Form 118c, Related Personal Property.

§ 101-47.4902-4 Instructions for the preparation of Standard Form 118, and Attachments, Standard Forms 118a, 118b, and 118c.

§ 101-47.4904 GSA Form 1334, Request for Transfer of Excess Real and Related Personal Property.

NOTE: The illustrations in §101-47.4904 are filed as part of the original document and do not appear in the FEDERAL REGISTER or the Code of Federal Regulations.

[42 FR 40698, Aug. 11, 1977]

§ 101-47.4904-1 Instructions for preparation of GSA Form 1334, Request for Transfer of Excess Real and Related Personal Property.

NOTE: The illustrations in §101-47.4904-1 are filed as part of the original document and do not appear in the FEDERAL REGISTER or the Code of Federal Regulations.

[42 FR 40698, Aug. 11, 1977]

§ 101-47.4905 Extract of statutes authorizing disposal of surplus real property to public agencies.

Statute: 16 U.S.C. 667b-d. Disposals for wildlife conservation purposes.

Type of property*: Any surplus real property (with or without improvements) that can be utilized for wildlife conservation purposes other than migratory birds, exclusive of (1) oil, gas, and mineral rights, and (2) property which the holding agency has requested reimbursement of the net proceeds of disposition pursuant to section 204(c) of the Act.

Eligible public agency: The agency of the State exercising the administra-

41 CFR Ch. 101 (7-1-01 Edition)

tion of the wildlife resources of the State.

Statute: 23 U.S.C. 107 and 317. Disposals for Federal aid and other highways.

Type of property*: Any real property or interests therein determined by the Secretary of Transportation to be reasonably necessary for the right-of-way of a Federal aid or other highway (including control of access thereto from adjoining lands) or as a source of material for the construction or maintenance of any such highway adjacent to such real property or interest therein, exclusive of (1) oil, gas, and mineral rights; and (2) property which the holding agency has requested reimbursement of the net proceeds of disposition pursuant to section 204(c) of the Act.

Eligible public agency: State wherein the property is situated (or such political subdivision of the State as its law may provide), including the District of Columbia and Commonwealth of Puerto Rico.

Statute: 40 U.S.C. 122. Transfer to the District of Columbia of jurisdiction over properties within the District for administration and maintenance under conditions to be agreed upon.

Type of property: Any surplus real property, except property for which the holding agency has requested reimbursement of the net proceeds of disposition pursuant to section 204(c) of the Act.

Eligible public agency: District of Columbia.

Statute: 40 U.S.C. 345c. Disposals for authorized widening of public highways, streets, or alleys.

Type of property*: Such interest in surplus real property as the head of the disposal agency determines will not be adverse to the interests of the United States, exclusive of (1) oil, gas and mineral rights; (2) property subject to disposal for Federal aid and other highways under the provisions of 3 U.S.C. 107 and 317; and (3) property which the holding agency has requested reimbursement of the net proceeds of disposition pursuant to section 204(c) of the Act.

Eligible public agency: State or political subdivision of a State.

Federal Property Management Regulations

§ 101-47.4905

Statute: 40 U.S.C. 484(e)(3)(H). Disposals by negotiations.

Type of property: Any surplus real property including related personal property.

Eligible public agency: Any State; the District of Columbia; any territory or possession of the United States; and any instrumentality, political subdivision, or tax-supported agency in any of them.

Statute: 40 U.S.C. 484(k)(1)(A). Disposals for school, classroom, or other educational purposes.

Type of property*: Any surplus real property, including buildings, fixtures, and equipment situated thereon, exclusive of (1) oil, gas, and mineral rights; and (2) property which the holding agency has requested reimbursement of the net proceeds of disposition pursuant to section 204(c) of the Act.

Eligible public agencies: Any State; the District of Columbia; any territory or possession of the United States; and any instrumentality, political subdivision, or tax-supported educational institution in any of them.

Statute: 40 U.S.C. 484(k)(1)(B). Disposals for public health purposes including research.

Type of property*: Any surplus real property, including buildings, fixtures, and equipment situated thereon, exclusive of (1) oil, gas, and mineral rights; and (2) property which the holding agency has requested reimbursement of the net proceeds of disposition pursuant to section 204(c) of the Act.

Eligible public agencies: Any State; the District of Columbia; any territory or possession of the United States; and any instrumentality, political subdivision, or tax-supported medical institution in any of them.

Statute: 40 U.S.C. 484(k)(2). Disposals for public park or recreation areas.

Type of property*: Any surplus real property recommended by the Secretary of the Interior as being needed for use as a public park or recreation area, including buildings, fixtures, and equipment situated thereon, exclusive of (1) oil, gas, and mineral rights; (2) improvements without land; (3) property which the holding agency has requested reimbursement of the net proceeds of disposition pursuant to section 204(c) of the Act.

Eligible public agencies: Any State; the District of Columbia; any territory or possession of the United States; and any instrumentality or political subdivision in any of them.

Statute: 40 U.S.C. 484(k)(3). Disposals for historic monuments.

Type of property: Any surplus real and related personal property, including buildings, fixtures, and equipment situated thereon, exclusive of (1) oil, gas, and mineral rights; (2) improvements without land; (3) property which the holding agency has requested reimbursement of the net proceeds of disposition pursuant to section 204(c) of the Act. Before property may be conveyed under this statute, the Secretary of the Interior must determine that the property is suitable and desirable for use as a historic monument for the benefit of the public. No property shall be determined to be suitable or desirable for use as a historic monument except in conformity with the recommendation of the Advisory Board on National Parks, Historic Sites, Buildings, and Monuments established by section 3 of the act entitled "An Act for the preservation of historic American sites, buildings, objects, and antiquities of national significance, and for other purposes," approved Aug. 21, 1935 (49 Stat. 666), and only so much of any such property shall be so determined to be suitable or desirable for such use as is necessary for the preservation and property observation of its historic features. The Administrator of General Services may authorize the use of the property conveyed under this subsection for revenue-producing activities if the Secretary of the Interior (1) determines that such activities are compatible with use of the property for historic monument purposes, (2) approves the grantee's plan for repair, rehabilitation, restoration, and maintenance of the property, (3) approves grantee's plan for financing repairs, rehabilitation, restoration, and maintenance of the property which must provide that incomes in excess of the costs of such items shall be used by the grantee only for public historic preservation, park, or recreational purposes,

§ 101-47.4905

41 CFR Ch. 101 (7-1-01 Edition)

and (4) approves the grantee's accounting and financial procedures for recording and reporting on revenue-producing activities.

Eligible public agencies: Any State; the District of Columbia; any territory or possession of the United States; and any instrumentality or political subdivision in any of them.

Statute: 40 U.S.C. 484(k)(6). Disposals for self-help housing and housing assistance.

Type of property*: Any surplus real and related personal property, including buildings, fixtures, and equipment situated thereon, exclusive of (1) oil, gas, and mineral rights; (2) improvements without land; and (3) property which the holding agency has requested reimbursement of the net proceeds of disposition pursuant to section 204(c) of the Act. Before property may be conveyed under this statute, the Secretary of the Housing and Urban Development must recommend that the property is needed for providing self-help housing or housing assistance for low-income individuals or families.

Eligible public agencies: Any State, any political subdivision or instrumentality of a State, or any nonprofit organization that exists for the primary purpose of providing self-help housing or housing assistance for low-income individuals or families.

Statute: 40 U.S.C. 484(p). Disposals for correctional facility, law enforcement, or emergency management response purposes.

Type of property*: Any surplus real and related personal property, including buildings, fixtures, and equipment situated thereon, exclusive of (1) oil, gas, and mineral rights; (2) improvements without land; and (3) property which the holding agency has requested reimbursement of the net proceeds of disposition pursuant to section 204(c) of the Act. Before property may be conveyed under this statute, the Attorney General must determine that the property is required for correctional facility use under an appropriate program or project approved by the Attorney General for the care or rehabilitation of criminal offenders or for law enforcement use. Before property may be conveyed under this statute for emergency management response use,

the Director of the Federal Emergency Management Agency must determine that the property is required for such use.

Eligible public agencies: Any State; the District of Columbia; any territory or possession of the United States; and any political subdivision or instrumentality thereof.

Statute: 40 U.S.C. 484(q). Disposals for port facility purposes.

Type of property: Any surplus real and related personal property, including buildings, fixtures, and equipment situated thereon, exclusive of (1) oil, gas, and mineral rights; (2) improvements without land; (3) property which the holding agency has requested reimbursement of the net proceeds of disposition pursuant to section 204(c) of the Act. Before property may be conveyed under this statute, the Secretary of Transportation must determine, after consultation with the Secretary of Labor, that the property is located in an area of serious economic disruption; and approve, after consultation with the Secretary of Commerce, an economic development plan associated with the plan of use of the property.

Eligible public agencies: Any State; the District of Columbia; any territory or possession of the United States; and any instrumentality or political subdivision in any of them.

Statute: 49 U.S.C. 47151. Disposals for public airport purposes.

Type of property*: Any surplus real or personal property, exclusive of (1) oil, gas and mineral rights; (2) property subject to disposal as a historic monument site under the provisions of Sec. 101-47.308-3; (3) property the highest and the best use of which is determined by the disposal agency to be industrial and which shall be so classified for disposal, and (4) property which the holding agency has requested reimbursement of the net proceeds of disposition pursuant to section 204(c) of the Act.

Eligible public agencies: Any State, the District of Columbia; any territory or possession of the United States; and any instrumentality or political subdivision in any of them.

Statute: 50 U.S.C. App. 1622(d). Disposals of power transmission lines needful for or adaptable to the requirements of a public power project.

Federal Property Management Regulations

§ 101-47.4906

Type of property*: Any surplus power transmission line and the right-of-way acquired for its construction.

Eligible public agency: Any State or political subdivision thereof or any State agency or instrumentality.

*The Commissioner, Public Buildings Service, General Services Administration, Washington, DC 20405, in appropriate instances, may waive any exclusions listed in this description, except for those required by law.

[60 FR 35708, July 11, 1995, as amended at 64 FR 5619, Feb. 4, 1999]

§ 101-47.4906 Sample notice to public agencies of surplus determination.

NOTICE OF SURPLUS DETERMINATION—
GOVERNMENT PROPERTY

(Date)

(Name of property)

(Location)

Notice is hereby given that the above described property has been determined to be surplus Government property. The property consists of _____ acres of fee land, more or less, together with easements and improvements as follows:

This property is surplus property available for disposal under the provisions of the Federal Property and Administrative Services Act of 1949 (40 U.S.C. 471 *et seq.*), as amended, certain related laws, and applicable regulations. The applicable regulations provide that non-Federal public agencies shall be allowed a reasonable period of time to submit a formal application for surplus real property in which they may be interested. Disposal of this property, or portions thereof, may be made to public agencies for the public uses listed below whenever the Government determines that the property is available for such uses and that disposal thereof is authorized by the statutes cited and applicable regulations. (NOTE: List only those statutes and types of disposal appropriate to the particular surplus property described in the notice.)

- 16 U.S.C. 667b- Wildlife conservation.
- d.
- 20 U.S.C. 107 Federal aid and certain and 317. other highways.

- 40 U.S.C. 122 .. Transfer to the District of Columbia.
- 40 U.S.C. 345c Widening of highways, streets, or alleys.
- 40 U.S.C. 484(e)(3)(H). Negotiated sales for general public purpose uses. (NOTE: This statute should not be listed if the affected surplus property has an estimated value of less than \$10,000.)
- 40 U.S.C. 484(k)(1)(A). School, classroom, or other educational purposes.
- 40 U.S.C. 484(k)(1)(B). Protection of public health, including research.
- 40 U.S.C. 484(k)(2). Public park or recreation area.
- 40 U.S.C. 484(k)(3). Historic monument.
- 40 U.S.C. 484(k)(6). Self-help housing and housing assistance.
- 40 U.S.C. 484(p). Correctional facility, law enforcement, or emergency management response.
- 40 U.S.C. 484(q). Port facility.
- 49 U.S.C. 47151 Public airport.
- 50 U.S.C. App. 1622(d). Power transmission lines.

If any public agency desires to acquire the property under any of the cited statutes, notice thereof must be filed in writing with

(Insert name and address of disposal agency):

Such notice must be filed not later than ____
(Insert date of the 21st day following the date of the notice.)

- Each notice so filed shall:
- (a) Disclose the contemplated use of the property;
 - (b) Contain a citation of the applicable statute or statutes under which the public agency desires to procure the property;
 - (c) Disclose the nature of the interest if an interest less than fee title to the property is contemplated;
 - (d) State the length of time required to develop and submit a formal application for the property. (Where a payment to the Government is required under the statute, include a statement as to whether funds are available and, if not, the period required to obtain funds.); and
 - (e) Give the reason for the time required to develop and submit a formal application.

§ 101-47.4906a

41 CFR Ch. 101 (7-1-01 Edition)

Upon receipt of such written notices, the public agency shall be promptly informed concerning the period of time that will be allowed for submission of a formal application. In the absence of such written notice, or in the event a public use proposal is not approved, the regulations issued pursuant to authority contained in the Federal Property and Administrative Services Act of 1949 provide for offering the property for sale.

Application forms or instructions to acquire property for the public uses listed in this notice may be obtained by contacting the following Federal agencies for each of the indicated purposes:

NOTE: For each public purpose statute listed in this notice, show the name, address, and telephone number of the Federal agency to be contacted by interested public body applicants.)

[60 FR 35710, July 11, 1995, as amended at 64 FR 5619, Feb. 4, 1999]

§ 101-47.4906a Attachment to notice sent to zoning authority.

FEDERAL PROPERTY AND ADMINISTRATIVE SERVICES ACT OF 1949, AS AMENDED

TITLE VIII—URBAN LAND UTILIZATION

DISPOSAL OF URBAN LANDS

SEC. 803

(a) Whenever the Administrator contemplates the disposal for or on behalf of any Federal agency of any real property situated within an urban area, he shall, prior to offering such land for sale, give reasonable notice to the head of the governing body of the unit of general local government having jurisdiction over zoning and land-use regulation in the geographical area within which the land or lands are located in order to afford the government the opportunity of zoning for the use of such land in accordance with local comprehensive planning.

(b) The Administrator, to the greatest practicable extent, shall furnish to all prospective purchasers of such real property, full and complete information concerning:

(1) Current zoning regulations and prospective zoning requirements and objectives for such property when it is unzoned; and

(2) Current availability to such property of streets, sidewalks, sewers, water, street lights, and other service facilities and prospective availability of such services if such property is included in comprehensive planning.

[34 FR 11210, July 3, 1969]

§ 101-47.4906b Paragraph to be added to letter sent to zoning authority.

As the head of the governing body of the unit of general local government having jurisdiction over zoning and land-use regulations in the geographical area within which this surplus property is located, you also may be interested in section 803 of the Federal Property and Administrative Services Act of 1949, as amended, 82 Stat. 1105, a copy of which is attached for ready reference. It is requested that the information contemplated by section 803(b) be forwarded this office within the same 20-calendar-day period prescribed in the attached notice of surplus determination for the advising of a desire to acquire the property. If the property is unzoned and you desire the opportunity to accomplish such zoning in accordance with local comprehensive planning pursuant to section 803(a), please so advise us in writing within the same time frame and let us know the time you will require for the promulgation of such zoning regulations. We will not delay sale of the property pending such zoning for more than 50 days from the date of this notice. However, if you will not be able to accomplish the desired zoning before the property is placed on sale, we will advise prospective purchasers of the pending zoning in process.

[34 FR 11210, July 3, 1969]

§ 101-47.4906-1 Sample letter for transmission of notice of surplus determination.

(Date)

CERTIFIED MAIL—RETURN RECEIPT REQUESTED

(Addressee)

Dear _____: The former _____ (Name of property), _____ (Location) has been determined to be surplus Government property and available for disposal.

Included in the attached notice are a description of the property and procedural instructions to be followed if any public agency desires to submit an application for the property. Please note particularly the name and address given for filing written notice if

Federal Property Management Regulations

§ 101-47.4908

any public agency desires to submit such an application, the time limitation within which written notice must be filed, and the required content of such notice. Additional instructions are provided for the submission of comments regarding any incompatibility of the disposal with any public agency's development plans and programs.

In order to ensure that all interested parties are informed of the availability of this property, please post the additional copies of the attached notice in appropriate conspicuous places.¹

A notice of surplus determination also is being mailed to _____ (Other addressees).

Sincerely,

Attachment

[34 FR 11211, July 3, 1969, as amended at 35 FR 8487, June 2, 1970]

§ 101-47.4906-2 Sample letter to a State single point of contact.

(Date)

(Addressee)

Dear: _____

On July 14, 1982, the President issued Executive Order 12372, "Intergovernmental Review of Federal Programs." This Executive order provides for State and local government coordination and review of certain proposed Federal programs and activities, including real property disposal actions of the General Services Administration.

Enclosed is a notice of surplus determination that has been sent to appropriate public bodies advising them of the availability of the described real property for public purposes. Surplus Federal real property which is not acquired for State or local governmental public purposes is generally offered for sale to the general public by competitive bidding procedures.

No final disposal action will be taken for 60 calendar days from the date of this letter to allow for the receipt of any comments from your office.

[52 FR 9831, Mar. 27, 1987]

§ 101-47.4907 List of Federal real property holding agencies.

NOTE: The illustrations in §101-47.4907 are filed as part of the original document and do

¹Attach as many copies of the notice as may be anticipated will be required for adequate posting.

not appear in the FEDERAL REGISTER or the Code of Federal Regulations.

[40 FR 12080, Mar. 17, 1975]

§ 101-47.4908 Excess profits covenant.

EXCESS PROFITS COVENANT FOR NEGOTIATED SALES TO PUBLIC BODIES

(a) This covenant shall run with the land for a period of 3 years from the date of conveyance. With respect to the property described in this deed, if at any time within a 3-year period from the date of transfer of title by the Grantor, the Grantee, or its successors or assigns, shall sell or enter into agreements to sell the property, either in a single transaction or in a series of transactions, it is covenanted and agreed that all proceeds received or to be received in excess of the Grantee's or a subsequent seller's actual allowable costs will be remitted to the Grantor. In the event of a sale of less than the entire property, actual allowable costs will be apportioned to the property based on a fair and reasonable determination by the Grantor.

(b) For purposes of this covenant, the Grantee's or a subsequent seller's allowable costs shall include the following:

- (1) The purchase price of the real property;
- (2) The direct costs actually incurred and paid for improvements which serve only the property, including road construction, storm and sanitary sewer construction, other public facilities or utility construction, building rehabilitation and demolition, landscaping, grading, and other site or public improvements;
- (3) The direct costs actually incurred and paid for design and engineering services with respect to the improvements described in (b)(2) of this section; and
- (4) The finance charges actually incurred and paid in conjunction with loans obtained to meet any of the allowable costs enumerated above.

(c) None of the allowable costs described in paragraph (b) of this section will be deductible if defrayed by Federal grants or if used as matching funds to secure Federal grants.

(d) In order to verify compliance with the terms and conditions of this covenant, the Grantee, or its successors or assigns, shall submit an annual report for each of the subsequent 3 years to the Grantor on the anniversary date of this deed. Each report will identify the property involved in this transaction and will contain such of the following items of information as are applicable at the time of submission:

- (1) A description of each portion of the property that has been resold;
- (2) The sale price of each such resold portion;
- (3) The identity of each purchaser;
- (4) The proposed land use; and

§ 101-47.4909

41 CFR Ch. 101 (7-1-01 Edition)

(5) An enumeration of any allowable costs incurred and paid that would offset any realized profit.

If no resale has been made, the report shall so state.

(e) The Grantor may monitor the property and inspect records related thereto to ensure compliance with the terms and conditions of this covenant and may take any actions which it deems reasonable and prudent to recover any excess profits realized through the resale of the property.

[51 FR 23760, July 1, 1986]

§ 101-47.4909 Highest and best use.

(a) Highest and best use is the most likely use to which a property can be put, so as to produce the highest monetary return from the property, promote its maximum value, or serve a public or institutional purpose. The highest and best use determination must be based on the property's economic potential, qualitative values (social and environmental) inherent in the property itself, and other utilization factors controlling or directly affecting land use (e.g. zoning, physical characteristics, private and public uses in the vicinity, neighboring improvements, utility services, access, roads, location, and environmental and historical considerations). Projected highest and best use should not be remote, speculative, or conjectural.

(b) An analysis and determination of highest and best use is based on information compiled from the property inspection and environmental assessment. Major considerations include:

(1) Present zoning category (check one or more as appropriate).

- Industrial
Single family residential
Multiple family residential
Commercial/retail
Warehouse
Agriculture
Institutional or public use

Other (specify)

- Not zoned
Zoning proceeding pending Federal disposal

Category proposed

(2) Physical characteristics. (Describe land and improvements and comment on property's physical characteristics including utility services,

access, environmental and historical aspects, and other significant factors)

(3) Area/neighborhood uses (check one or more as appropriate).

- Single family residential
Multiple family residential
Industrial
Office
Retail or commercial
Farmland
Recreational/park area

Other (specify)

(4) Existing neighboring improvements (check one or more as appropriate).

- Deteriorating
Stable
Some recent development
Significant recent development

Vicinity improvements:
Dense Moderate Sparse None

(5) Environmental factors/constraints adversely affecting the marketability of the property (check one or more as appropriate).

- Severe slope or soil instability
Road access
Access to sanitary sewers or storm sewers
Access to water supply
Location within or near floodplain
Wetlands
Tidelands
Irregular shape
Present lease agreement or other possessory non-Federal interest
Historic, archeological or cultural
Contamination or other hazards

Other (specify)

Comments on adverse conditions

(6) Former Government uses (check one or more as appropriate).

- Office
Industrial
Warehouse or storage
Residential
Retail/commercial
Agricultural

Specify other uses below, such as airport, health, education, recreation and special military facilities—

Federal Property Management Regulations

§ 101-47.4912

(c) Determination of highest and best use (check one or more as appropriate).

Single family residential _____

Multiple family residential _____

Industrial _____

Office _____

Retail or commercial _____

Agricultural _____

Warehouse/storage _____

Transportation _____

Historic monument _____

Recreation/park _____

Health _____

Education or related institutional use _____

Airport _____

Wildlife Conservation _____

Public utility _____

Other (include general public or governmental).

Remarks: _____

(d) Are significant costs required to make property conform to highest and best use (i.e. demolition of existing improvements, relocation of existing improvements, etc.)?

Remarks: _____

(e) Can a knowledgeable cost estimate be given in reference to paragraph d above? (Enter figure).

Yes (\$ _____) _____

No _____

(f) Is the property located adjacent to or inside the boundaries of a State park, forest or recreational area?

Yes _____

No _____

Remarks _____

[49 FR 37091, Sept. 21, 1984]

§ 101-47.4910 Field offices of Department of Health, Education, and Welfare.

NOTE: The illustrations in §101-47.4910 are filed as part of the original document and do not appear in the FEDERAL REGISTER or the Code of Federal Regulations.

[40 FR 12080, Mar. 17, 1975]

§ 101-47.4911 Outline for explanatory statements for negotiated sales.

NOTE: The illustration listed in § 101-47.4911 is filed as part of the original document and does not appear in the FEDERAL REGISTER or the Code of Federal Regulations.

[42 FR 31455, June 21, 1977]

§ 101-47.4912 Regional offices of the Bureau of Outdoor Recreation, Department of the Interior.

Address communications to: Regional Director, Bureau of Outdoor Recreation, Department of the Interior.

Region and jurisdiction	Address and telephone
Northeast region: Connecticut, Delaware, Maine, Maryland, Massachusetts, New Hampshire, New Jersey, New York, Pennsylvania, Rhode Island, Vermont, Virginia, West Virginia, and District of Columbia.	Federal Bldg., 600 Arch St., Philadelphia, Pa. 19106. Code 215, 597-7989
Southeast region: Alabama, Florida, Georgia, Kentucky, Mississippi, North Carolina, Puerto Rico, South Carolina, Tennessee, and Virgin Islands.	148 Cain St., Atlanta, Ga. 30303. Code 404, 526-4405.
Lake Central region: Illinois, Indiana, Michigan, Minnesota, Ohio, and Wisconsin	3853 Research Park Dr., Ann Arbor, Mich. 48104. Code 313, 769-3211
Midcontinent region: Colorado, Iowa, Kansas, Missouri, Montana, Nebraska, North Dakota, South Dakota, Utah, and Wyoming.	Building 41, Denver Federal Center, P.O. Box 25387, Denver, Colo. 80225. Code 303, 234-2634
South Central region: Arkansas, Louisiana, New Mexico, Oklahoma, and Texas	Patio Plaza Bldg., 5000 Marble Ave., NE., Albuquerque, N. Mex. 87110. Code 505, 843-3514
Northwest region: Alaska, Idaho, Oregon, and Washington	United Pacific Bldg., 1000 Second Ave., Seattle, Wash. 98104. Code 206, 442-4706
Pacific Southwest region: American Samoa, Arizona, California, Guam, Hawaii, and Nevada.	Box 36062, 450 Golden Gate Ave., San Francisco, Calif. 94102. Code 415, 556-0182

[40 FR 22260, May 22, 1975]

§ 101-47.4913 Outline for protection and maintenance of excess and surplus real property.

A. *General.* In protecting and maintaining excess and surplus properties, the adoption of the principle of "calculated risk" is considered to be essential. In taking what is termed a "calculated risk," the expected losses and deteriorations in terms of realizable values are anticipated to be less in the overall than expenditures to minimize the risks. In determining the amount of protection to be supplied under this procedure, a number of factors should be considered; such as, the availability of, and the distance to, local, public, or private protection facilities; the size and value of the facility; general characteristics of structures; physical protection involving fencing, number of gates, etc.; the location and availability of communication facilities; and the amount and type of activity at the facility. Conditions at the various excess and surplus properties are so diverse that it is impracticable to establish a definite or fixed formula for determining the extent of protection and maintenance that should be applied. The standards or criteria set forth in B and C, below, are furnished as a guide in making such determinations.

B. *Protection Standards.* The following standards are furnished as a guide in determining the amount and limits of protection.

1. *Properties not Requiring Protection Personnel.* Fire protection or security personnel are not needed at:

- (a) Facilities where there are no structures or related personal property;
- (b) Facilities where the realizable or recoverable value of the improvements and related personal property subject to loss is less than the estimated cost of protection for a one-year period;
- (c) Facilities of little value located within public fire and police department limits, which can be locked or boarded up;
- (d) Facilities where the major buildings are equipped with automatic sprinklers, supervised by American District Telegraph Company or other central station service, which do not contain large quantities of readily removable personal property, and which are in an area patrolled regularly by local police; and
- (e) Facilities where agreements can be made with a lessee of a portion of the property to protect the remaining portions at nominal, or without additional cost.

2. *Properties Requiring a Resident Custodian.* A resident custodian or guard only is required at facilities of the following classes:

- (a) Facilities containing little removable personal property but having a considerable

number of buildings to be sold for off-site use when (a) the buildings are of low realizable value and so spaced that loss of more than a few buildings in a single fire is improbable, or (b) the buildings are so located that water for firefighting purposes is available and municipal or other fire department services will respond promptly;

- (b) Small, inactive industrial and commercial facilities which must be kept open for inspection and which are so located that public fire and police protection can be secured by telephone;

- (c) Facilities where the highest and best use has been determined to be salvage; and

- (d) Facilities of little, or salvage, value but potentially dangerous and attractive to children and curiosity seekers where the posting of signs is not sufficient to protect the public.

3. *Properties Requiring Continuous Guard Service.* One guard on duty at all times (a total of 5 guards required) is required at facilities of high market value which are fenced; require only one open gate which can be locked during patrols; all buildings of which can be locked; and where local police and fire protection can be secured by telephone.

4. *Properties Requiring High Degree of Protection.* More than one firefighter-guard will be required to be on duty at all times at facilities of the classes listed below. The number, and the assignment, of firefighter-guards in such cases should be determined by taking into consideration all pertinent factors.

- (a) Facilities of high market value which are distant from public assistance and require an on-the-site firefighting force adequate to hold fires in check until outside assistance can be obtained.

- (b) Facilities of high market value which can obtain no outside assistance and require an on-the-site firefighting force adequate to extinguish fires.

- (c) Facilities of high market value at which the patrolling of large areas is necessary.

- (d) Facilities of high market value not fenced and containing large quantities of personal property of a nature inviting pilferage.

- (e) Facilities of high market value at which several gates must be kept open for operating purposes.

5. *Standards for All Protected Properties.*

- (a) All facilities within the range of municipal or other public protection, but outside the geographic limits of such public body, should be covered by advance arrangements with appropriate authorities for police and fire protection service, at a monthly or other service fee if necessary.

(b) Patrolling of all facilities with large areas to be protected should be accomplished by use of automotive vehicles.

(c) At fenced facilities, a minimum number of gates should be kept open.

6. *Firefighter-Guards.* Firefighters and guards are the normal means for carrying out the fire protection and security programs at excess and surplus real properties where both such programs are required. The duties of firefighters and guards should be combined to the maximum extent possible in the interest of both economy and efficiency. Such personnel would also be available in many cases for other miscellaneous services, such as, removing grass and weeds or other fire hazards, servicing fire extinguishers, and other activities related to general protection of property.

7. *Operating Requirements of Protection Units.* Firefighter-guards or guards, should be required to make periodic rounds of facilities requiring protection. The frequency of these rounds would be based upon a number of factors; such as, location and size of the facility, type of structures and physical barriers, and the amount and type of activity at the facility. There may be instances where some form of central station supervision, such as American District Telegraph Company, will effect reduction in costs by reducing the number of firefighter-guards, or guards, required to adequately protect the premises.

8. *Watchman's Clock.* To insure adequate coverage of the entire property by the guards, or firefighter-guards, an approved watchman's clock should be provided, with key stations strategically located so that, in passing from one to the other, the guards will cover all portions of the property.

9. *Protection Alarm Equipment.* Automatic fire detection devices and allied equipment and services may materially assist in minimizing protection costs. However, use of devices of this type, like guards, are purely secondary fire protection and are primarily a means of obtaining fire and police protection facilities at the property in an emergency. There are various types of devices, each of which can be considered separately or in combination as supplementing guard patrols, which may assist in reduction of costs and, in some instances, it may be possible to eliminate all guards.

10. *Sentry Dogs.* Frequently there are facilities of high market value, or which cover large areas, or are so isolated that they invite intrusion by curiosity seekers, hunters, vagrants, etc., which require extra or special protection measures. This has usually been taken care of by staffing with additional guards so that the "buddy system" of patrolling may be used. In such cases, the use of sentry dogs should be considered in arriving at the appropriate method of offsetting the need for additional guards, as well as pos-

sible reductions in personnel. If it is determined to be in the Government's interest to use this type of protection, advice should be obtained as to acquisition (lease, purchase, or donation), training, use, and care, from the nearest police department using sentry dogs. When sentry dogs are used, the property should be clearly posted "Warning—This Government Property Patrolled by Sentry Dogs."

C. *Maintenance Standards.* The following standards or criteria are furnished as a guide in connection with the upkeep of excess and surplus real properties:

1. *Temporary Type Buildings and Structures.* Temporary buildings housing personal property which cannot be readily removed to permanent type storage should be maintained only to the extent necessary to protect the personal property. Vacant temporary structures should not be maintained except in unusual circumstances.

2. *Permanent Type Buildings and Structures.* (a) No interior painting should be done. Where exterior wood or metal surfaces require treatment to prevent serious deterioration, spot painting only should be done when practicable.

(b) Carpentry and glazing should be limited to: work necessary to close openings against weather and pilferage; making necessary repairs to floors, roofs, and sidewalls as a protection against further damage; shoring and bracing of structures to preclude structural failures; and similar operations.

(c) Any necessary roofing and sheet metal repairs should, as a rule, be on a patch basis.

(d) Masonry repairs, including brick, tile, and concrete construction, should be undertaken only to prevent leakage or disintegration, or to protect against imminent structural failure.

(e) No buildings should be heated for maintenance purposes except in unusual circumstances.

3. *Mechanical and Electrical Installations.* These include plumbing, heating, ventilating, air conditioning, sprinkler systems, fire alarm systems, electrical equipment, elevators, and similar items.

(a) At facilities in inactive status, maintenance of mechanical and electrical installations should be limited to that which is necessary to prevent or arrest serious deterioration. In most cases, personnel should not be employed for this work except on a temporary basis at periodic intervals when it is determined by inspections that the work is necessary. Wherever possible electrical systems should be deenergized, water drained from all fixtures, heat turned off, and buildings secured against unauthorized entry. Sprinkler systems should be drained during freezing weather and reactivated when danger of freezing has passed.

(b) At facilities in active status, such as multiple-tenancy operations, equipment

should be kept in reasonable operating condition. Operation of equipment to furnish services to private tenants, as well as the procurement of utility services for distribution to tenants, should be carried on only to the extent necessary to comply with lease or permit conditions, or in cases where it is impracticable for tenants to obtain such services directly from utility companies or other sources.

(c) At facilities where elevators and/or high-pressure boilers and related equipment are in operation, arrangements should be made for periodic inspections by qualified and licensed inspectors to insure that injury to personnel, loss of life, or damage to property does not occur.

(d) Individual heaters should be used, when practicable, in lieu of operating heating plants.

4. *Grounds, Roads, Railroads, and Fencing.*

(a) Maintenance of grounds should be confined largely to removal of vegetation where necessary to avoid fire hazards and to control poisonous and noxious plant growth in accordance with local and State laws and regulations; plowing of fire lanes where needed; and removal of snow from roads and other areas only to the extent necessary to provide access for maintenance, fire protection, and similar activities. Wherever practicable, hay crops should be sold to the highest bidders with the purchaser performing all labor in connection with cutting and removal. Also, agricultural and/or grazing leases may be resorted to, if practicable, as other means of reducing the cost of grounds maintenance. Any such leases shall be subject to the provisions of § 101-47.203-9 or § 101-47.312.

(b) Only that portion of the road network necessary for firetruck and other minimum traffic should be maintained. The degree to which such roads are to be maintained should be only that necessary to permit safe passage at a reasonable speed.

(c) Railroads should not be maintained except as might be required for protection and maintenance operations, or as required under the provisions of a lease or permit.

(d) Ditches and other drainage facilities should be kept sufficiently clear to permit surface water to run off.

(e) Fencing, or other physical barrier, should be kept in repair sufficiently to afford protection against unauthorized entry.

5. *Utilities.* (a) At inactive properties, water systems, sewage disposal systems, electrical distribution systems, etc., should be maintained only to the extent necessary to provide the minimum services required. Buildings or areas not requiring electrical service or water should be deenergized electrically and the water valved off. Utilities not in use, or which are serving dismantled or abandoned structures, should not be maintained.

(b) At active properties, water supply, electrical power, and sewage disposal facilities frequently must be operated at rates much below designed capacities. Engineering studies should determine the structural and operating changes necessary for maximum economy. Where leakage is found in water distribution lines, such lines may be valved off rather than repaired, unless necessary for fire protection or other purposes.

(c) Where utilities are purchased by contract, such contracts should be reviewed to determine if costs can be reduced by revision of the contracts.

6. *Properties to be Disposed of as Salvage.* No funds should be expended for maintenance on properties where the highest and best use has been determined to be salvage.

D. *Repairs.* Repairs should be limited to those additions or changes that are necessary for the preservation and maintenance of the property to deter or prevent excessive, rapid, or dangerous deterioration or obsolescence and to restore property damaged by storm, flood, fire, accident, or earthquake only where it has been determined that restoration is required.

E. *Improvements.* No costs should be incurred to increase the sales value of a property, and no costs should be incurred to make a property disposable without the prior approval of GSA. (See § 101-47.401-5.)

[29 FR 16126, Dec. 3, 1964, as amended at 30 FR 11281, Aug. 2, 1965]

§ 101-47.4914 Executive Order 12512.

NOTE: The illustrations in § 101-47.4914 are filed as part of the original document and do not appear in this volume.

[50 FR 194, Jan. 3, 1986]

PART 101-48—UTILIZATION, DONATION, OR DISPOSAL OF ABANDONED AND FORFEITED PERSONAL PROPERTY

Sec.

- 101-48.000 Scope of part.
- 101-48.001 Definitions.
- 101-48.001-1 Abandoned or other unclaimed property.
- 101-48.001-2 Distilled spirits.
- 101-48.001-3 Eleemosynary institution.
- 101-48.001-4 Firearms.
- 101-48.001-5 Forfeited property.
- 101-48.001-6 Malt beverages.
- 101-48.001-7 Property.
- 101-48.001-8 Voluntarily abandoned property.
- 101-48.001-9 Wine.
- 101-48.001-10 Drug paraphernalia.

Federal Property Management Regulations

§ 101-48.001-3

Subpart 101-48.1—Utilization of Abandoned and Forfeited Personal Property

- 101-48.100 Scope of subpart.
- 101-48.101 Forfeited or voluntarily abandoned property.
 - 101-48.101-1 Sources of property available for utilization.
 - 101-48.101-2 Custody of property.
 - 101-48.101-3 Cost of care and handling.
 - 101-48.101-4 Retention by holding agency.
 - 101-48.101-5 Property required to be reported.
 - 101-48.101-6 Transfer to other Federal agencies.
 - 101-48.101-7 Reimbursement and costs incident to transfer.
 - 101-48.101-8 Billing.
 - 101-48.101-9 Disposition of proceeds.
- 101-48.102 Abandoned or other unclaimed property.
 - 101-48.102-1 Vesting of title in the United States.
 - 101-48.102-2 Reporting.
 - 101-48.102-3 Reimbursement.
 - 101-48.102-4 Proceeds.

Subpart 101-48.2—Donation of Abandoned and Forfeited Personal Property

- 101-48.200 Scope of subpart.
- 101-48.201 Donation of forfeited distilled spirits, wine, and malt beverages.
 - 101-48.201-1 General.
 - 101-48.201-2 Establishment of eligibility.
 - 101-48.201-3 Requests by institutions.
 - 101-48.201-4 Filing requests.
 - 101-48.201-5 Donation of lots not required to be reported.
 - 101-48.201-6 Packing and shipping costs.
- 101-48.202 Donation of forfeited drug paraphernalia.

Subpart 101-48.3—Disposal of Abandoned and Forfeited Personal Property

- 101-48.300 Scope of subpart.
- 101-48.301 General.
- 101-48.302 Distilled spirits, wine, and malt beverages.
- 101-48.303 Firearms.
- 101-48.304 Drug paraphernalia.
- 101-48.305 Property other than distilled spirits, wine, malt beverages, firearms, and drug paraphernalia.
- 101-48.306 Disposition of proceeds from sale.
 - 101-48.306-1 Abandoned or other unclaimed property.
 - 101-48.306-2 Forfeited or voluntarily abandoned property.

Subparts 101-48.4—101-48.48 [Reserved]

Subpart 101-48.49—Illustrations of Forms

- 101-48.4900 Scope of subpart.
- 101-48.4901 [Reserved]

- 101-48.4902 GSA forms.
- 101-48.4902-18 GSA Form 18, Application of Eleemosynary Institution.

AUTHORITY: Sec. 205(c), 63 Stat. 390; 40 U.S.C. 486(c).

SOURCE: 42 FR 55813, Oct. 19, 1977, unless otherwise noted.

§ 101-48.000 Scope of part.

This part prescribes the policies and methods governing the utilization, donation, and disposal of abandoned and forfeited personal property under the custody or control of any Federal agency in the United States, the Commonwealth of Puerto Rico, American Samoa, Guam, the Trust Territory of the Pacific Islands, and the Virgin Islands. In addition to the requirements of this part 101-48, the disposition of abandoned and forfeited hazardous materials shall be accomplished in accordance with part 101-42.

[57 FR 39137, Aug. 28, 1992]

§ 101-48.001 Definitions.

For the purposes of this part 101-48, the following terms shall have the meanings set forth in this section.

§ 101-48.001-1 Abandoned or other unclaimed property.

Abandoned or other unclaimed property means personal property that is found on premises owned or leased by the Government and which is subject to the filing of a claim therefor by the former owner(s) within 3 years from the vesting of title in the United States.

§ 101-48.001-2 Distilled spirits.

Distilled spirits, as defined in the Federal Alcohol Administration Act (27 U.S.C. 211), as now in force or hereafter amended, means ethyl alcohol; hydrated oxide of ethyl; or spirits of wine, whiskey, rum, brandy, gin, and other distilled spirits, including all dilutions and mixtures thereof.

§ 101-48.001-3 Eleemosynary institution.

Eleemosynary institution means a non-profit institution organized and operated for charitable purposes whose net income does not inure in whole or in part to the benefit of shareholders or

§ 101-48.001-4

individuals and which shall have filed with the GSA National Capital Region a satisfactory statement establishing such status.

[56 FR 40260, Aug. 14, 1991]

§ 101-48.001-4 Firearms.

Firearms, as defined in 18 U.S.C. 921, as now in force or hereafter amended, means any weapon (including a starter gun) which will, or is designed to, or may readily be converted to expel a projectile by the action of an explosive; the frame or receiver of any such weapon or any firearm muffler or firearm silencer; or any destructive device. This term does not include an antique firearm.

§ 101-48.001-5 Forfeited property.

Forfeited property means personal property acquired by a Federal agency either by summary process or by order of a court of competent jurisdiction pursuant to any law of the United States.

§ 101-48.001-6 Malt beverages.

Malt beverages, as defined in the Federal Alcohol Administration Act (27 U.S.C. 211), as now in force or hereafter amended, means beverages made by the alcoholic fermentation of an infusion or decoction, or combination of both, in potable brewing water, of malted barley with hops or their parts or products and with or without other malted cereals; and with or without the addition of unmalted or prepared cereals, other carbohydrates, or products prepared therefrom; and with or without the addition of carbon dioxide; and with or without other wholesome products suitable for human food consumption.

§ 101-48.001-7 Property.

Property means all personal property, including but not limited to vessels, vehicles, aircraft, distilled spirits, wine, and malt beverages.

§ 101-48.001-8 Voluntarily abandoned property.

Voluntarily abandoned property means personal property abandoned to a Federal agency in such a manner as to vest title thereto in the United States.

41 CFR Ch. 101 (7-1-01 Edition)

§ 101-48.001-9 Wine.

Wine means any of the wines defined in sections 5381 and 5385 of the Internal Revenue Code of 1954 (26 U.S.C. 5381, 5385), as now in force or hereafter amended, and other alcoholic beverages not so defined, but made in the manner of wine, including sparkling and carbonated wine; wine made from condensed grape must; wine made from agricultural products other than the juice of sound, ripe grapes; imitation wine; compounds sold as wine; vermouth; cider; perry; and sake. The alcoholic content of these beverages shall not contain less than 7 percent nor more than 24 percent of alcohol by volume and shall not be for industrial use.

§ 101-48.001-10 Drug paraphernalia.

Drug paraphernalia means any equipment, product, or material of any kind which is primarily intended or designed for use in manufacturing, compounding, converting, concealing, producing, processing, preparing, injecting, ingesting, inhaling, or otherwise introducing into the human body a controlled substance in violation of the Controlled Substances Act (title II of Pub. L. 91-513). It includes items primarily intended or designed for use in ingesting, inhaling, or otherwise introducing marijuana, cocaine, hashish, hashish oil, PCP, or amphetamines into the human body, such as:

- (1) Metal, wooden, acrylic, glass, stone, plastic, or ceramic pipes with or without screens, permanent screens, hashish heads, or punctured metal bowls;
- (2) Water pipes;
- (3) Carburetion tubes and devices;
- (4) Smoking and carburetion masks;
- (5) Roach clips: Meaning objects used to hold burning material, such as a marijuana cigarette, that has become too small or too short to be held in the hand;
- (6) Miniature spoons with level capacities of one-tenth cubic centimeter or less;
- (7) Chamber pipes;
- (8) Carburetor pipes;
- (9) Electric pipes;
- (10) Air-driven pipes;
- (11) Chillums;
- (12) Bong;

Federal Property Management Regulations

§ 101-48.101-4

- (13) Ice pipes or chillers;
- (14) Wired cigarette papers; or
- (15) Cocaine freebase kits.

[56 FR 40260, Aug. 14, 1991]

Subpart 101-48.1—Utilization of Abandoned and Forfeited Personal Property

§ 101-48.100 Scope of subpart.

This subpart 101-48.1 prescribes the policies and methods for utilization and transfer within the Government of forfeited or voluntarily abandoned personal property subject to the provisions of 40 U.S.C. 304f through m, and abandoned and other unclaimed property found on premises owned or leased by the Government subject to the provisions of 40 U.S.C. 484(m), which may come into the custody or control of any Federal agency in the United States, the Commonwealth of Puerto Rico, American Samoa, Guam, and Trust Territory of the Pacific Islands, or the Virgin Islands. Property in this category located elsewhere shall be utilized and transferred in accordance with the regulations of the agency having custody thereof. This subpart also governs seized and forfeited drug paraphernalia under the provisions of 21 U.S.C. 857(c).

[56 FR 40260, Aug. 14, 1991]

§ 101-48.101 Forfeited or voluntarily abandoned property.

Forfeited or voluntarily abandoned property, subject to the provisions of 40 U.S.C. 304(f) through m, except as otherwise indicated in this subpart 101-48.1, shall be reported and handled in the same manner as excess property under subpart 101-43.3.

§ 101-48.101-1 Sources of property available for utilization.

Property available for utilization under § 101-48.101 is property which is in the custody or under the control of any agency of the U.S. Government, as a result of forfeiture or voluntary abandonment.

§ 101-48.101-2 Custody of property.

(a) GSA generally will not take possession of property that is forfeited or voluntarily abandoned. Such property

shall remain in the custody of and be the responsibility of the holding agency.

(b) GSA will direct the disposition of forfeited firearms that are subject to the disposal provisions of 26 U.S.C. 5872(b). GSA authorizes the retention of any such firearm by the Secretary of the Treasury or his delegate for official use.

(c) GSA will direct the disposition of distilled spirits, wine, and malt beverages that are forfeited other than by court decree or by order of a court:

(1) By transfer to Government agencies which have a need for such beverages for medicinal, scientific, or mechanical purposes, or for any other purpose for which appropriated funds may be expended by a Government agency;

(2) By donation to eleemosynary institutions (as defined in § 101-48.001-3) which have a need for such beverages for medicinal purposes; or

(3) By destruction.

(d) GSA will direct the disposition of forfeited drug paraphernalia that is subject to the disposal provisions of 21 U.S.C. 857(c) by ordering such paraphernalia destroyed or by authorizing its use for law enforcement or educational purposes by Federal, State, or local authorities.

[42 FR 55813, Oct. 19, 1977, as amended at 56 FR 40260, Aug. 14, 1991]

§ 101-48.101-3 Cost of care and handling.

Each holding agency shall be responsible for performing care and handling of forfeited or voluntarily abandoned personal property pending disposition.

§ 101-48.101-4 Retention by holding agency.

(a) Subject to the limitations on certain types of passenger vehicles (see § 101-43.307-9), a Federal agency may retain and devote to official use any property in its custody that is forfeited other than by court decree or determined by the agency to be voluntarily abandoned. Large sedans and limousines may be retained by an agency and devoted to official use only if such retention is clearly authorized by the provisions of subpart 101-38.1.

(b) A holding agency, when reporting property pursuant to § 101-48.101-5,

§ 101-48.101-5

41 CFR Ch. 101 (7-1-01 Edition)

which is subject to pending court proceedings for forfeiture, may at the same time file a request for that property for its official use. A request for only components or accessories of a complete and operable item shall contain a detailed justification concerning the need for the components or accessories and an explanation of the effect their removal will have on the item. Upon receipt of a request, GSA will make application to the court requesting delivery of the property to the holding agency, provided that, when a holding agency has requested only components or accessories of a complete and operable item, GSA determines that their removal from the item is in the best interest of the Government.

(c) Except where otherwise specifically provided, any property that is retained by a Federal agency for official use under this subpart 101-48.1 shall thereupon lose its identity as forfeited or voluntarily abandoned property. When such property is no longer required for official use, it shall be reported as excess in accordance with § 101-43.304.

(Sec. 307, 49 Stat. 880; 40 U.S.C. 3041)

[42 FR 55813, Oct. 19, 1977, as amended at 44 FR 42202, July 19, 1979; 56 FR 40260, Aug. 14, 1991]

§ 101-48.101-5 Property required to be reported.

(a) A Federal agency shall promptly report, in accordance with § 101-43.304, property in its custody that is forfeited other than by court decree or voluntarily abandoned and not desired for retention by that agency for its official use and property on which proceedings for forfeiture by court decree are being started or have begun, except that:

(1) Reports shall be submitted to the GSA National Capital Region (mailing address: General Services Administration (3FBP-W), Washington, DC 20407) in lieu of being submitted to the GSA regional office for the region in which the property is located.

(2) The reporting agency's internal documents containing information relevant to the property may be used in lieu of the Standard Form 120, Report of Excess Personal Property; and

(3) Distilled spirits, wine and malt beverages fit for human consumption in quantities of 5 wine gallons or more shall be reported regardless of acquisition cost.

(b) The following information shall be furnished:

(1) Whether property was:

(i) Abandoned;

(ii) Forfeited other than by court decree; or

(iii) The subject of a court proceeding and, if so, the name of the defendant and the place and judicial district of the court from which the decree has been or will be issued;

(2) Existence or probability of a lien or claim of lien, or other accrued or accruing charges, and the amount involved; and

(3) If the property is distilled spirits, wine, or malt beverages: Quantities and kinds (rye or bourbon or other whiskey and its brand, if any; sparkling or still wine and its color or brand; cordial, brandy, gin, etc.), proof rating, and condition for shipping.

(c) In addition to the exceptions and special handling described in §§ 101-43.305 and 101-43.307, the following forfeited or voluntarily abandoned property need not be reported:

(1) Forfeited arms or munitions of war which are handled pursuant to 22 U.S.C. 401;

(2) Forfeited firearms which are transferable by the holding agency to the Secretary of Defense;

(3) Abandoned, condemned, or forfeited tobacco, snuff, cigars, or cigarettes which the holding agency estimates will not, if offered for sale by competitive bid, bring a price equal to the internal revenue tax due and payable thereon; and which is subject to destruction or delivery without payment of any tax to any hospital maintained by the United States for the use of present or former members of the military or naval forces of the United States;

(4) Forfeited distilled spirits (including alcohol), wine and malt beverages not fit for human consumption nor for medicinal, scientific, or mechanical purposes. (Domestic forfeited distilled spirits, wine, and malt beverages which were not produced at a registered distillery, winery, or brewery or which are

Federal Property Management Regulations

§ 101-48.101-5

in containers that have been opened or entered shall be regarded as not fit for human consumption. (See §101-48.302 for disposition.);

(5) Distilled spirits, wine, and malt beverages in any one seizure of less than 5 wine gallons (see §§101-48.201-5 and 101-48.302 for disposition);

(6) Effects of deserters from the Coast Guard or the military services, or of deceased persons of the Coast Guard or the military services, or of deceased inmates of naval or soldiers' homes or Government hospitals;

(7) Seeds, plants, or misbranded packages seized by the Department of Agriculture pursuant to authorities provided by law;

(8) Game and equipment (other than vessels, including cargo) seized by the Department of the Interior pursuant to authorities provided by law;

(9) Files of papers, all dead and undeliverable mail matter, and non-mailable matter in the custody of the Postmaster General;

(10) Infringing articles in the custody of the Patent Office, Department of Commerce;

(11) Unclaimed and abandoned personal property subject to applicable customs laws and regulations;

(12) Collection seizures to satisfy tax liens and property acquired by the United States in payment of or as security for debts arising under the internal revenue laws;

(13) Property, the vesting and disposition of which is controlled by the provisions of 38 U.S.C. 5201 (*et seq.*), Disposition of deceased veterans' personal property; and

(14) Motor vehicles which are 4 or more years old.

(d) The general rule for reporting specified in this §101-48.101-5 is modified with respect to the following:

(1) Controlled substances (as defined in §101-43.001-3), regardless of quantity, condition, or acquisition cost, shall be reported to the Drug Enforcement Administration, Department of Justice, Washington, DC 20537;

(2) Forfeited firearms not desired for retention by the seizing agency, except those covered by paragraphs (c) (1) and (2) of this section, shall be reported provided such firearms are in excellent serviceable condition and known to be

used for law enforcement or security purposes or are sufficiently unusual to be of interest to a Federal museum. Forfeited firearms not reportable in accordance with the foregoing criteria shall be destroyed and disposed of pursuant to §101-48.303;

(3) Property forfeited other than by court decree which is suitable for human consumption or which may be used in the preparation of food may be immediately transferred by the agency having custody to the nearest Federal agency known to be a user of such property, without specific authorization from GSA;

(4) Vessels of 1,500 gross tons or more which the Maritime Administration determines to be merchant vessels or capable of conversion to merchant use shall be reported to the Maritime Administration;

(5) Property seized by one Federal agency but adopted by another for prosecution under laws enforced by the adopting Federal agency shall be reported by the adopting agency to the extent and in the manner required by this subpart 101-48.1;

(6) Lost, abandoned, or unclaimed personal property controlled by the provisions of 10 U.S.C. 2575 shall be disposed of as provided by 10 U.S.C. 2575 and regulations issued thereunder by appropriate authority; and

(7) Drug paraphernalia seized and forfeited under the provisions of 21 U.S.C. 857, which is not retained for official use by the seizing agency or transferred to another Federal agency under seizing agency authorities, or such drug paraphernalia retained for official use but no longer required by the agency, shall be reported on Standard Form 120 to the General Services Administration, Property Management Division (FBP), Washington, DC 20406.

(e) Property not required to be reported pursuant to this §101-48.101-5 and not excepted or modified with respect to reporting pursuant to this §101-48.101-5 shall be handled as set forth in §101-43.305.

[42 FR 55813, Oct. 19, 1977, as amended at 56 FR 40260, Aug. 14, 1991]

§ 101-48.101-6

41 CFR Ch. 101 (7-1-01 Edition)

§ 101-48.101-6 Transfer to other Federal agencies.

(a) Normally, the transfer of forfeited or voluntarily abandoned personal property shall be accomplished by submitting for approval a Standard Form 122, Transfer Order Excess Personal Property (see §101-43.4901-122), or any other transfer order form approved by GSA, to the General Services Administration (3FBP-W), Washington, DC 20407, for approval.

(b) Except for property which is subject to court action, the transfer order shall indicate the agency having custody of the property, the location of the property, the report or case number on which the property is listed, the property required, and the fair value, if applicable.

(c) Property subject to court action may be requested by submitting a transfer order or a letter setting forth the need for the property by the agency. If proceedings for the forfeiture of the property by court decree are being started or have begun, application will be made by GSA to the court, prior to entry of a decree, for an order requiring delivery of the property to an appropriate recipient for its official use.

(d) Transfers of forfeited or voluntarily abandoned distilled spirits, wine, and malt beverages shall be limited to those for medicinal, scientific, or mechanical purposes or for any other official purposes for which appropriated funds may be expended by a government agency. Transfer orders shall be signed by the head of the requesting agency or a designee. Where officials are designed to sign, the General Services Administration (3FBP-W), Washington, DC 20407, shall be advised of designees by letter signed by the head of the agency concerned. No transfer order will be acted upon unless it is signed as provided herein.

(e) Transfer orders requesting the transfer of forfeited or voluntarily abandoned firearms shall set forth the need for the property by the requesting agency.

(f) Transfer orders requesting the transfer of reportable forfeited drug paraphernalia shall be submitted to the General Services Administration, Property Management Division (FBP), Washington, DC 20406, for approval.

Transfers will not be approved unless the Standard Form 122 or other transfer document contains a certification that the paraphernalia will be used for law enforcement or educational purposes only.

(g) Any property transferred for official use under this subpart 101-48.1, with the exception of drug paraphernalia, shall thereupon lose its identity as forfeited or voluntarily abandoned property. When no longer required for official use, it shall be reported as excess in accordance with §101-43.304. Drug paraphernalia shall not lose its identity as forfeited property. When no longer required for official use, it shall be reported in accordance with §101-48.101-5(d)(7).

[42 FR 55813, Oct. 19, 1977, as amended at 56 FR 40261, Aug. 14, 1991]

§ 101-48.101-7 Reimbursement and costs incident to transfer.

(a) Reimbursement upon transfer of personal property forfeited or voluntarily abandoned other than by court decree shall be in accordance with §101-43.309-3.

(b) Reimbursement for judicially forfeited property shall be in accordance with provisions of the court decree.

(c) Commercial charges incurred at the time of and subsequent to forfeiture or voluntary abandonment but prior to transfer shall be borne by the transferee agency when billed by the commercial organization.

(d) The direct costs incurred by the holding agency prior to the transfer of forfeited or voluntarily abandoned property shall be borne by the transferee agency when billed by the holding agency. Overhead or administrative costs or charges shall not be included. Only costs set forth in 40 U.S.C. 304j, such as storage, packing, preparation for shipment, loading, and transportation shall be recovered by the holding agency.

[42 FR 55813, Oct. 19, 1977, as amended at 56 FR 40261, Aug. 14, 1991]

§ 101-48.101-8 Billing.

(a) Each holding agency shall be responsible for billing and collecting the costs of care and handling, as well as the fair value of property transferred

Federal Property Management Regulations

§ 101-48.200

to other agencies, when such reimbursement is required in accordance with §101-43.309-3.

(b) Commercial organizations accruing charges prior to transfer shall be responsible for billing and collecting these charges from the transferee agency.

[42 FR 55813, Oct. 19, 1977, as amended at 56 FR 40261, Aug. 14, 1991]

§ 101-48.101-9 Disposition of proceeds.

Where reimbursement for fair value is to be made in accordance with §101-43.309-3, the fair value proceeds shall be deposited in the Treasury to miscellaneous receipts or in the appropriate agency account by the transferor agency.

[56 FR 40261, Aug. 14, 1991]

§ 101-48.102 Abandoned or other unclaimed property.

§ 101-48.102-1 Vesting of title in the United States.

Abandoned or other unclaimed property, subject to the provisions of section 203(m) of the Federal Property and Administrative Services Act of 1949, as amended (40 U.S.C. 484(m)), shall remain in the custody of and be the responsibility of the agency finding such property. The property shall be held for a period of 30 days from the date of finding such property. Upon expiration of this 30-day period, title to such property vests in the United States, except that title reverts to the owner where a proper claim is filed by the owner prior to official use or transfer for official use and, if there is no official use or transfer for official use, prior to sale of the property.

§ 101-48.102-2 Reporting.

(a) Abandoned or other unclaimed property not utilized by the holding agency shall be reported and handled in the same manner as excess property under subpart 101-43.3, except as provided in §101-48.102-2(b).

(b) Abandoned for other unclaimed property which, by the provisions of §101-43.304, is not required to be reported and which is not otherwise

transferred pursuant to subpart 101-43.3, shall be subject to the provisions of subpart 101-48.3.

[42 FR 55813, Oct. 19, 1977, as amended at 56 FR 40261, Aug. 14, 1991]

§ 101-48.102-3 Reimbursement.

Reimbursement of fair market value, as determined by the head of the finding or transferor agency, shall be required in connection with official use by the finding agency or transfer for official use of abandoned or other unclaimed property. Fair market value as used herein does not mean fair value as determined under §101-43.309-3.

[56 FR 40261, Aug. 14, 1991]

§ 101-48.102-4 Proceeds.

Reimbursement for official use by the finding agency or transfer for official use of abandoned or other unclaimed property shall be deposited in a special fund by the finding or transferor agency for a period of at least 3 years. A former owner may be reimbursed from the special fund, based upon a proper claim made to the finding or transferor agency and filed within 3 years from the date of vesting of title in the United States. Such reimbursement shall not exceed fair market value at the time title was vested in the United States, less the costs incident to the care and handling of such property as determined by the head of the agency concerned.

Subpart 101-48.2—Donation of Abandoned and Forfeited Personal Property

§ 101-48.200 Scope of subpart.

This subpart 101-48.2 prescribes the policies and methods governing the donation by Federal agencies of abandoned and forfeited property in their custody or control in the United States, the Commonwealth of Puerto Rico, American Samoa, Guam, the Trust Territory of the Pacific Islands, or the Virgin Islands.

§ 101-48.201

41 CFR Ch. 101 (7-1-01 Edition)

§ 101-48.201 Donation of forfeited distilled spirits, wine, and malt beverages.

§ 101-48.201-1 General.

Forfeited distilled spirits, wine, and malt beverages for which there is no Federal utilization shall be made available to appropriate eleemosynary institutions prior to other disposition.

§ 101-48.201-2 Establishment of eligibility.

Eleemosynary institutions desiring to obtain available distilled spirits, wine, and malt beverages shall submit GSA Form 18, Application of Eleemosynary Institution (see § 101-48.4902-18), to the General Services Administration (3FBP-W), Washington, DC 20407. The Office of Management and Budget Approval Number 3090-0001 has been assigned to this form.

[56 FR 40261, Aug. 14, 1991]

§ 101-48.201-3 Requests by institutions.

Eligible institutions desiring to obtain available distilled spirits, wine, and malt beverages shall show on the GSA Form 18, Application of Eleemosynary Institution, the kind and quantity desired. The GSA National Capital Region will inform the eligible institution when these alcoholic beverages become available, request confirmation that the institution's requirement is current, and inform the institution that shipment will be initiated upon this confirmation.

[56 FR 40261, Aug. 14, 1991]

§ 101-48.201-4 Filling requests.

The GSA National Capital Region will authorize the seizing agency to fill such requests as the region may determine proper to ensure equitable distribution among requesting institutions.

[56 FR 40262, Aug. 14, 1991]

§ 101-48.201-5 Donation of lots not required to be reported.

Forfeited distilled spirits, wine, and malt beverages not required to be reported under § 101-48.101-5 may be donated to eleemosynary institutions known to be eligible therefor if the

beverages are determined by the seizing agency to be suitable for human consumption. The holding agency shall promptly report these donations by letter to the General Services Administration (3FBP-W), Washington, DC 20407. This report shall state the quantity and type donated, the name and address of the donee institution, and date of the donation.

[56 FR 40262, Aug. 14, 1991]

§ 101-48.201-6 Packing and shipping costs.

The receiving institution shall pay all costs of packing, shipping, and transportation.

§ 101-48.202 Donation of forfeited drug paraphernalia.

(a) Forfeited drug paraphernalia for which there is no Federal utilization may be made available through State agencies, at the discretion of GSA, to State and local governments for law enforcement or educational purposes only. Donations will be made in accordance with part 101-44, except as otherwise provided in this subpart 101-48.2.

(b) All transfers of drug paraphernalia to the State agencies for donation to State and local governments shall be accomplished by use of SF 123, Transfer Order Surplus Personal Property (see § 101-44.4901-123). The SF 123 shall be accompanied by a letter of justification, signed and dated by the authorized representative of the proposed donee, setting forth a detailed plan of utilization for the property and certifying that the donee will comply with all Federal State, and local laws, regulations, ordinances, and requirements governing use of the property. The SF 123, with the letter of justification, shall be submitted for approval to the General Services Administration, Property Management Division (FBP), Washington, DC 20406.

(c) A State agency shall not pick up or store drug paraphernalia in its distribution centers. This property shall be released from the holding agency directly to the designated donee.

[56 FR 40262, Aug. 14, 1991]

Subpart 101-48.3—Disposal of Abandoned and Forfeited Personal Property

§ 101-48.300 Scope of subpart.

This subpart 101-48.3 prescribes the policies and methods governing the disposal of abandoned or other unclaimed, voluntarily abandoned, or forfeited personal property which may come into the custody or control of any Federal agency in the United States, the Commonwealth of Puerto Rico, American Samoa, Guam, the Trust Territory of the Pacific Islands, or the Virgin Islands. Property in this category located elsewhere shall be disposed of under the regulations of the agency having custody thereof.

§ 101-48.301 General.

Any property in the custody of a Federal agency which is not desired for retention by that agency nor utilized within any Federal agency in accordance with subpart 101-48.1 nor donated in accordance with subpart 101-48.2 shall be disposed of in accordance with the provisions of this subpart 101-48.3

§ 101-48.302 Distilled spirits, wine, and malt beverages.

(a) Distilled spirits, wine, and malt beverages (as defined in §101-48.001) which are not required to be reported under §101-48.101-5(c)(4) shall be destroyed as prescribed in §101-48.302(b); distilled spirits, wine, and malt beverages which are not required to be reported under §101-48.101-5(c)(5) and which have not been donated as prescribed in subpart 101-48.2 shall be destroyed in like manner.

(b) When reportable abandoned or forfeited distilled spirits, wine, and malt beverages are not retained by the holding agency, transferred to another agency, or donated to an eligible eleemosynary institution by GSA, the GSA National Capital Region will issue clearance to the agency which submitted the report as prescribed by §101-48.101-5 for destruction of the distilled spirits, wine, and malt beverages. A record of the destruction showing time, place, and nomenclature and quantities destroyed shall be filed with

papers and documents relating to the abandonment or forfeiture.

[42 FR 55813, Oct. 19, 1977, as amended at 56 FR 40262, Aug. 14, 1991]

§ 101-48.303 Firearms.

Abandoned or forfeited firearms or voluntarily abandoned firearms shall not be sold as firearms. They may be disposed of by sale as scrap in the manner prescribed in §101-45.309-4.

§ 101-48.304 Drug paraphernalia.

(a) When forfeited drug paraphernalia is neither utilized within any Federal agency in accordance with subpart 101-48.1 nor donated in accordance with subpart 101-48.2, GSA will issue clearance to the reporting agency to destroy the items. The destruction shall be performed by an employee of the holding agency in the presence of two additional employees of the agency as witnesses to the destruction. A statement of certification describing the fact, manner, date, type, and quantity destroyed shall be certified to by the agency employee charged with the responsibility for that destruction. The two agency employees who witnessed the destruction shall sign the following statement which shall appear on the certification below the signature of the certifying employee:

“I have witnessed the destruction of the (list the drug paraphernalia) described in the foregoing certification in the manner and on the date stated herein:”

Witness Date

Witness Date

(b) The signed certification and statement of destruction shall be made a matter of record and shall be retained in the case files of the holding agency.

[56 FR 40262, Aug. 14, 1991]

§ 101-48.305 Property other than distilled spirits, wine, malt beverages, firearms, and drug paraphernalia.

(a) Property forfeited other than by court decree or voluntarily abandoned, except distilled spirits, wine, malt beverages, firearms, and drug paraphernalia, which is not returned to a claimant, retained by the agency of

§ 101-48.306

custody, or transferred in accordance with subpart 101-48.1 may be released to the holding agency by the GSA National Capital Region for public sale, except as otherwise provided by law.

(b) Abandoned or other unclaimed property which is not retained by the holding agency, not transferred to another agency, or not required to be reported by the provisions of §101-48.102, may be reported for sale to the appropriate selling activity at any time after title vests in the United States as provided in §101-48.102-1.

(c) Voluntarily abandoned, abandoned, or other unclaimed property and, in the absence of specific direction by a court, forfeited property, normally shall be sold by competitive bid as prescribed in §101-45.304-1, subject to the same terms and conditions as would be applicable to the sale of surplus personal property. Voluntarily abandoned, abandoned, or other unclaimed property and forfeited property may be sold also by negotiation at the discretion of the selling agency but only under the circumstances set forth in §101-45.304-2. Such property shall be identified by the holding agency as abandoned or other unclaimed, voluntarily abandoned, or forfeited property, and shall be reported for sale to the appropriate GSA regional office or to such other agency as otherwise is responsible for selling its surplus personal property unless specifically required by law to be sold by the holding agency.

[56 FR 40262, Aug. 14, 1991]

§ 101-48.306 Disposition of proceeds from sale.

§ 101-48.306-1 Abandoned or other unclaimed property.

(a) Proceeds from sale of abandoned or other unclaimed property shall be deposited in a special fund by the finding agency for a period of 3 years. A former owner may be reimbursed for abandoned or other unclaimed property which had been disposed of in accordance with the provisions of this subpart 101-48.3 upon filing a proper claim with the finding agency within 3 years from the date of vesting of title in the United States. Such reimbursement shall not exceed the proceeds realized

41 CFR Ch. 101 (7-1-01 Edition)

from the disposal of such property less disposal costs and costs of the care and handling of such property as determined by the head of the agency concerned.

(b) Records of abandoned or other unclaimed property shall be maintained in such a manner as to permit identification of the property with the original owner, if known, when such property is offered for sale. Records of proceeds received from the sale of abandoned or other unclaimed property shall be maintained as part of the permanent file and record of sale until the 3-year period for filing claims has elapsed.

[56 FR 40262, Aug. 14, 1991]

§ 101-48.306-2 Forfeited or voluntarily abandoned property.

Proceeds from sale of property which has been forfeited other than by court decree, by court decree, or which has been voluntarily abandoned, shall be deposited in the Treasury of the United States as miscellaneous receipts or in such other agency accounts as provided by law or regulations.

[56 FR 40262, Aug. 14, 1991]

Subparts 101-48.4—101-48.48 [Reserved]

Subpart 101-48.49—Illustrations of Forms

§ 101-48.4900 Scope of subpart.

This subpart illustrates forms prescribed for use in connection with subject matter covered in this part 101-48.

§ 101-48.4901 [Reserved]

§ 101-48.4902 GSA forms.

(a) GSA Form 18, Application of Eleemosynary Institution, is illustrated in this §101-48.4902 to show the text, format, and arrangement of the form and to provide a ready source of reference.

(b) Copies of the GSA Form 18 may be obtained from the General Services Administration (WDP), Washington, DC 20407.

[42 FR 55813, Oct. 19, 1977, as amended at 46 FR 39593, Aug. 4, 1981]

Federal Property Management Regulations

Ch. 101, Subch. H, App.

§ 101-48.4902-18 GSA Form 18, Application of Eleemosynary Institution.

NOTE: The form illustrated at §101-48.4902-18 is filed with the original document.

PART 101-49—UTILIZATION, DONATION, AND DISPOSAL OF FOREIGN GIFTS AND DECORATIONS

AUTHORITY: Sec. 205(c), 63 Stat. 390 (40 U.S.C. 486(c)); sec. 515, 91 Stat. 862 (5 U.S.C. 7342).

SOURCE: 65 FR 45539, July 24, 2000, unless otherwise noted.

§ 101-49.000 Cross-reference to the Federal Management Regulation (FMR) (41 CFR chapter 102, parts 102-1 through 102-220).

For information on utilization, donation, and disposal of foreign gifts and decorations previously contained in this part, see FMR part 42 (41 CFR part 102-42).

APPENDIX TO SUBCHAPTER H—TEMPORARY REGULATIONS

[EDITORIAL NOTE: The following is a list of temporary regulations, except delegations of authority, which relate to Federal property management and are in effect as of the revision date of this volume. The full text of these temporary regulations appears following this table.]

FPMR Temp. Reg.	Subject	Expires	FR Publication
H-29	Criteria for reporting excess personal property.	July 31, 2000	62 FR 2022, Jan. 15, 1997; 62 FR 68217, Dec. 31, 1997; 64 FR 1139, Jan. 8, 1999; 64 FR 72570, Dec. 28, 1999
H-30	Donation of Federal surplus personal property to non-profit providers of assistance to impoverished families and individuals.	Feb. 21, 2000	63 FR 8352, Feb. 19, 1998

FEDERAL PROPERTY MANAGEMENT REGULATIONS TEMPORARY REGULATION H-29

To: Heads of Federal agencies
 Subject: Criteria for reporting excess personal property

1. *Purpose.* This regulation establishes revised criteria for reporting excess personal property to GSA, reduces utilization screening time, raises the dollar threshold for direct transfers, and updates addresses associated with reporting excess personal property.

2. *Effective date.* This regulation is effective January 15, 1997.

3. *Expiration date.* This regulation expires January 15, 1998.

4. *Applicability.* This regulation applies to all executive agencies.

5. *Background.*

a. Certain excess property is reportable to GSA by executive agencies for the purpose of maximizing opportunities for utilization. Property which is reported to GSA is afforded regional and nationwide visibility by inclusion in GSA's automated property disposal system—the Federal Disposal System (FEDS). Once an item is in the FEDS nationwide inventory of excess and surplus property, agencies can determine the availability of property by phoning the supporting GSA regional office, obtaining a copy of the FEDS inventory listing, or by accessing an electronic bulletin board within FEDS containing the nationwide inventory—Screen by

Computer and Request Excess by Electronic Notification (SCREEN)

b. GSA's major personal property management customers have requested relief from reporting requirements by reducing the number of items of excess property to be reported. GSA is granting these requests provided such reductions do not result in an appreciable decline in overall transfer volumes of excess personal property. GSA conducted a study to assess the potential impact of reduced reporting requirements. The analysis showed that over 70 percent of the dollar value of property transferred represented Federal supply classification (FSC) groups which would continue to be reported to GSA as excess under the new reporting requirements.

c. Changes to the reporting criteria will be reexamined after an implementation period of 1 year to determine their net effect on overall business volumes. A significant decline in the utilization rate (dollar value of property transfers divided by dollar value of property generations) would be sufficient justification for modifying or rescinding the regulation.

d. GSA provided approval to the Department of Defense on July 20, 1994, to implement throughout its nationwide network of Defense Reutilization and Marketing Offices (DRMO's) a streamlined disposal concept known as single cycle processing. Under this concept, utilization screening time of excess

property reported to GSA is reduced from 60 to 21 calendar days. Federal respondents to a follow-up customer survey indicated that 21 calendar days is sufficient time for screening Department of Defense excess property. A study group consisting of GSA and Federal and State representatives recommended that reduced screening time also be applied to civilian agency excess property.

6. *Definitions.* For purposes of this regulation, the following definitions apply:

a. "Reportable property" means personal property that is required to be reported to GSA in accordance with FPMR 101-43.304 prior to disposal.

b. "Nonreportable property" means any personal property that does not meet the reporting criteria set forth in FPMR 101-43.304, and therefore is not required to be reported formally to GSA, but which is available locally for Federal transfer or donation.

7. *Explanation of changes.*

a. Section 101-42.205 is amended by removing paragraph (b) and redesignating paragraph (c) as paragraph (b) and revising it to read as follows:

§ 101-42.205 Exceptions to reporting.

(a) * * *

(b) When EPA, under its authorities, transfers accountability for hazardous materials to Federal, State, and local agencies, to research institutions, or to commercial businesses to conduct research or to perform the actual cleanup of a contaminated site, the item shall not be reported.

b. Section 101-42.402 is amended by revising paragraphs (a), (b), and (c) and adding paragraph (d) to read as follows:

§ 101-42.402 Reporting hazardous materials for sale.

* * * * *

(a) *Reportable property.* Personal property which is reportable property and is identified as hazardous must be reported to a GSA regional office for utilization screening in accordance with §101-42.204. If, after reporting to GSA, the hazardous materials are not transferred or donated, in accordance with subparts 101-42.2 through 101-42.3 and 101-42.11, the hazardous materials will be programmed for sale by GSA, unless advised otherwise by the holding agency in accordance with part 101-45, without further documentation from the holding agency.

(b) *Nonreportable property.* Under §101-42.202, holding agencies are required to identify and label hazardous materials. Listings of personal property which is nonreportable property and is identified as hazardous must be made available to GSA area utilization officers for local utilization and donation screening in accordance with §101-42.204 and §101-42.205. If property has not been reported and is to be sold by GSA, it must be reported

to GSA for sale on Standard Form 126, Report of Personal Property for Sale, or by automated means which GSA is capable of accepting.

(c) *Certification and Description.* The SF 126 shall contain a certification, executed by a duly authorized agency official, in block 16c or as an addendum, that the item has been clearly labeled and packaged as required in §101-42.202(e) and 101-42.204. The SF 126 shall also contain or be accompanied by a full description of the actual or potential hazard associated with handling, storage, or use of the item. Such description shall be furnished by providing:

(1) An MSDS or copy thereof; or

(2) A printed copy of the record, corresponding to the hazardous material being reported, from the automated HMIS; or

(3) A written narrative, included in either block 16c or as an addendum, which complies with the requirements of 29 CFR 1910.1200.

(d) Property not subject to GSA screening. Hazardous material which may not be reported to GSA in accordance with §101-42.204 and §101-42.205 shall not be reported to GSA for sale unless GSA agrees to conduct such sale.

c. Section 101-43.001-30 is revised to read as follows:

§ 101-43.001-30 Screening period.

Screening period means:

(a) For reportable personal property of a civilian agency, the screening period is normally a period of 21 calendar days from the day following receipt of the automated report in FEDS or receipt of the manually completed report in the appropriate GSA office to and including the day specified as the surplus release date. For reportable property that is reported by a military activity during a period of property accumulation prior to a period of formal utilization screening, the screening period normally extends from the date of reporting to a period of 21 calendar days from the day following the date of the end of the accumulation.

(b) For civilian nonreportable property, the screening period is normally a period of 21 calendar days from the day the property is made available by the holding agency for screening as excess. For military nonreportable property that undergoes a period of accumulation prior to a period of utilization screening, the screening period is normally the same as for reportable property.

d. Section 101-43.001-34 is added to read as follows:

§ 101-43.001-34 Unit cost.

Unit cost means the original acquisition cost of a single item of property.

e. Section 101-43.302 is amended by revising paragraph (c) to read as follows:

§ 101-43.302 Agency responsibility.

* * * * *

Federal Property Management Regulations

Ch. 101, Subch. H, App.

(c) GSA will assist agencies in meeting their requirements for nonreportable property. Federal agencies requiring such property should contact the appropriate GSA regional office indicated in §101-43.4802. GSA area utilization officers, stationed at key excess generating points throughout the United States, screen and offer nonreportable property as it becomes available for transfer.

* * * * *

f. Section 101-43.304-1 is amended by revising paragraph (a) to read as follows:

§ 101-43.304-1 Reporting.

(a) Reportable property enumerated by the Federal supply classification (FSC) groups and classes, acquisition cost, and condition codes in §101-43.4801 shall be reported promptly to GSA with descriptions in sufficient detail to permit transfer or sale without further reference to the holding agency. In the absence of these descriptions, adequate commercial descriptions shall be substituted. Exceptions to these reporting requirements are covered in §101-43.305. Whenever possible, the national stock number (NSN) shall be provided as part of the description. It is essential that the excess personal property report reflect the true condition of the property as of the date it is reported excess through assignment of the appropriate disposal condition code designation as defined in §101-43.4801(e). Each Department of Defense excess personal property report must also contain the appropriate supply condition code as defined in §101-43.4801(f), including reports of contractor inventory so far as practicable. When available from property records, civilian agencies shall also include the appropriate supply condition code in excess personal property reports. To expedite processing, reports may be submitted up to 60 calendar days prior to the actual date of property availability, provided that the report clearly indicates this pending status and reflects the date on which the property will be determined excess.

* * * * *

g. Section 101-43.304-2 is amended by revising paragraph (b) to read as follows:

§ 101-43.304-2 Form and distribution of reports.

* * * * *

(b) The SF 120 and SF 120A shall be submitted in an original and three copies. Reporting by ADP media shall be as specified and approved by GSA. Reports shall be directed to the GSA regional office for the region in which the property is located (see

§101-43.4802). However, reports of fixed-wing and rotary-wing aircraft shall be submitted to the General Services Administration (9FB), San Francisco, CA 94102.

h. Section 101-43.304-4 is revised to read as follows:

§ 101-43.304-4 Property at installations due to be discontinued.

Executive agencies that have installations which are due to be discontinued, closed, or abandoned and at which there will be excess personal property shall, unless inadvisable in the interest of national security, give advance notice of such situations as early as possible by letter to the appropriate GSA regional office. In such cases, agencies shall identify the installations to be discontinued, provide the scheduled date for the removal of personnel from the location, and specify the last date when the personal property will be needed. As soon as possible after filing the advance notice, the excess personal property shall be reported in accordance with §101-43.304-1 to provide time for screening for Federal utilization and donation purposes, within forty-two calendar days when possible.

i. Section 101-43.305 is revised to read as follows:

§ 101-43.305 Nonreportable property and property not subject to GSA screening.

(a) Nonreportable property must be locally screened only, and it need not be reported to GSA for nationwide utilization screening. Such property is a valuable source of supply for Federal agencies; therefore, GSA regional offices and GSA area utilization officers are responsible for local screening of such property, for making it available to Federal agencies, and for its expeditious transfer. Holding agencies shall cooperate with GSA representatives in making information available and in providing access to nonreportable property. Federal agency employees shall be permitted access to holding installations for screening purposes upon presentation of a valid Federal agency employee's identification card.

(b) A listing of nonreportable property, providing the extended value in acquisition cost dollars of each line item and the total number of line items on the listing, must be made available to GSA area utilization officers for local utilization and donation screening. Agencies that have computer records of their excess/surplus personal property are encouraged to report nonreportable property electronically, in lieu of submitting hardcopy listings. Agencies that are not able to report nonreportable property electronically, and have nonreportable property which is to be sold by GSA if it survives utilization and donation screening, are encouraged to report that property on a Standard Form (SF) 120, in lieu of an excess listing, to eliminate the need to submit SF 126, Report

of Personal Property for Sale, after the completion of donation screening.

(c) In accordance with paragraph (d) of this section, certain kinds of property are not covered by the GSA utilization screening process. Such property is neither reportable property nor nonreportable property. It is the responsibility of the owning agency to screen such property and make reasonable efforts to obtain utilization among other Federal agencies. Although not required to do so, GSA may assist in the screening and transfer of such property when requested to do so by the owning agency or when otherwise directed by GSA.

(d) Unless otherwise directed by GSA, the following general categories of excess personal property are excepted from the GSA utilization screening process and shall not be reported to GSA for nationwide circularization nor made available to GSA area utilization officers for local screening:

- (1) Perishables, defined for the purposes of this section as any foodstuffs which are subject to spoilage or decay;
- (2) Property dangerous to public health and safety;
- (3) Scrap, except aircraft in scrap condition, provided the property strictly conforms to the definitions for scrap found at §101-43.001-29;
- (4) Property determined by competent authority to be classified or otherwise sensitive for reasons of national security;
- (5) Controlled substances in which case solicitation shall be limited to those agencies authorized for transfer under §101-42.1102-3 provisions;
- (6) Reportable property which, prior to reporting as required in §101-43.304, is transferred directly between Federal agencies as provided in §101-43.309-5(a) or by prearrangement with GSA to fill a known need;
- (7) Trading stamps and bonus goods (see §101-25.103-4);
- (8) Nonappropriated fund property;
- (9) Nuclear Regulatory Commission-controlled materials (see §101-42.1102-4 and 10 CFR parts 30 through 35, 40, and 70.); and
- (10) Hazardous waste and items determined by the holding agency to be extremely hazardous (see §101-42.402).

§ 101-43.307-7 [Amended]

j. Section 101-43.307-7 is amended by removing paragraph (a) and redesignating paragraph (b) as new paragraph (a) and paragraph (c) as new paragraph (b).

k. Section 101-43.307-12 is amended by revising paragraphs (c), (d), (e), and (f) to read as follows:

§ 101-43.307-12 Shelf-life items.

* * * * *

(c) Reportable shelf-life items which have a remaining useful life of 6 weeks or more be-

fore reaching the expiration date shall be reported as excess in accordance with §101-43.304. Agencies may, at their option, also report shelf-life items which are nonreportable property. The report shall identify the items in the description as shelf-life items by carrying the designation symbol "SL" and by showing the expiration date. If the item has an extendable-type expiration date, there shall also be furnished an indication as to whether the expiration date is the original or an extended date.

(d) Normally, items reported in accordance with paragraph (c) of this section, including medical shelf-life items held for national emergency purposes, will be given a surplus release date effective 21 calendar days from the date following the day the property was reported. This date may be shortened or extended according to utilization objectives and the remaining useful shelf life. However, GSA offices will screen shelf life items for both reportable property and nonreportable property to permit their use before the shelf life expires and the items are unfit for human use.

(e) Nonreportable shelf-life items which have a remaining useful life of 6 weeks or more before reaching the expiration date shall be made available for use by other Federal agencies as provided in §101-43.305. Agency documents listing such items shall show the expiration date and, in the case of items with an extendable expiration date, shall indicate whether the expiration date is the original or an extended date. When such items are determined excess, a surplus release date shall be established by the holding agency providing a minimum of 21 calendar days for utilization screening, unless determined otherwise by GSA. With the approval of GSA, the surplus release date may be extended by the holding agency when the items are selected by an authorized screener for transfer or are set aside by a GSA representative for potential or actual transfer. For controlled substances (as defined in §101-42.001), each executive agency shall comply with §101-42.1102-3.

(f) Shelf-life items which have a remaining useful life of less than 6 weeks, regardless of classification as reportable property or nonreportable property, shall be made available for utilization by other Federal agencies in the manner provided in paragraph (e) of this section.

* * * * *

l. Section 101-43.307-13 is revised to read as follows:

§ 101-43.307-13 Medical shelf-life items held for national emergency purposes.

(a) Whenever the head of an executive agency determines that the remaining storage or shelf-life of medical materials or supplies held for national emergency purposes is

of too short duration to justify their continued retention for such purposes and that their transfer or disposal would be in the best interest of the United States, those materials or supplies shall be considered to be nonreportable property unless otherwise directed by GSA. To the greatest extent practicable, the above determination shall be made at such time as to ensure that such medical materials or supplies can be transferred or otherwise disposed of in sufficient time to permit their use before their shelf-life expires and the items are unfit for human use.

(b) Excess medical shelf-life items regardless of the remaining useful life shall be made available for use by other Federal agencies as provided in §101-43.305. Each agency may also report excess medical shelf-life items to enhance the possibility of utilization through increased circularization. The excess report shall identify items as medical shelf-life items held for national emergency purposes by carrying the designating symbol "MSL" in the description of the report and by showing the shelf-life expiration date. Information shall also be furnished regarding whether the expiration date is the original or the extended date. Further, whenever medical shelf-life items held for national emergency purposes are reported as excess, any specialized storage requirements pertaining to the items listed thereon shall be noted on the report.

(c) When such items are determined excess, a surplus release date shall be established by the holding agency in accordance with §101-43.311-2. For controlled substances (as defined in §101-42.001), each executive agency shall comply with §101-42.1102-3.

(d) Transfers among Federal agencies of medical materials and supplies held for national emergency purposes and determined to be excess shall be accomplished in accordance with §101-43.309, except that such transfers shall be made upon such terms and prices as shall be agreed to by the Federal agencies concerned. Proceeds from such transfers may be credited to the current applicable appropriation or fund of the transferring agency and shall be available only for the purchase of medical materials or supplies for national emergency purposes.

m. Section 101-43.309-2 is amended by revising paragraphs (b) and (d) to read as follows: **§ 101-43.309-2 Information on availability.**

* * * * *

(b) Review of an electronic bulletin board called FEDS/SCREEN (Federal Disposal System/Screen by Computer and Request Excess by Electronic Notification) which contains

information on GSA's nationwide inventory of excess and surplus property;

* * * * *

(d) Submission of current and future requirements for excess personal property to the appropriate GSA regional office using GSA Form 1539, Request for Excess Personal Property, illustrated at §101-43.4902-1539. Instructions for submission of requirements may be obtained from any GSA regional office. Wherever possible, the NSN should be included for each item requested. GSA will assist agencies in obtaining NSN's to the extent practicable. If substitute items are acceptable, these should also be identified by NSN. Requirements for NSN items may be submitted electronically. If not currently available as excess, property requirements identified by NSN's will be retained for approximately 180 calendar days. Property reported excess during this time, if matched with recorded requirements, will be offered for immediate transfer. Agencies should update their lists of items at the end of each 180-calendar-day period to retain visibility in the requirements bank.

n. Section 101-43.309-5 is amended by revising paragraph (a) to read as follows:

§ 101-43.309-5 Procedure for effecting transfers.

(a) All transfers of excess personal property between Federal agencies shall be by SF 122, Transfer Order Excess Personal Property (see §101-43.4901-122), or any other transfer order form approved by GSA. Automated requests on approved forms and automated requests generated by FEDS/SCREEN may be used for excess personal property transfers. However, Federal agencies using automated requests shall ensure that document numbers are controlled and records maintained indicating the official authorized to approve property transfers. Except for automated transfer orders generated by FEDS/SCREEN, each transferee agency shall forward the original and three copies of the transfer order to the appropriate GSA regional office (see §101-43.4802) for approval. A SF 120 is not required in addition to SF 122 for direct transfers. Prior approval by GSA is not required when the appropriate GSA regional office is furnished an information copy of each direct transfer order by the transferor agency within 10 workdays from receipt of the order, and the property involved in the given transaction is:

- (1) Reportable property under §101-43.304 but has not yet been reported to GSA, the total acquisition cost of the transfer order does not exceed \$10,000, and the owning agency's regulations relative to internal distribution have been satisfied; or

Ch. 101, Subch. H, App.

41 CFR Ch. 101 (7-1-01 Edition)

(2) Nonreportable property under §101-43.305 and has not been reserved at the holding location for special screening by the appropriate GSA regional office, and the total acquisition cost of the transfer order does not exceed \$50,000.

* * * * *

o. Section 101-43.311-1 is revised to read as follows:

§101-43.311-1 Reportable property.

(a) Excess personal property, which is reported to GSA in accordance with §101-43.304 and not transferred to other Federal agencies shall become surplus at the close of business on the surplus release date, which is indicated on the report of excess personal property to GSA. With the exception of aircraft and vessels, the surplus release date will normally be 21 calendar days from the day after GSA receives the report of the excess personal property. The surplus release date for aircraft, and for vessels 1,500 gross tons and under in FSC Group 19, will be 60 calendar days from the day after GSA receives the report of excess in the appropriate GSA regional office.

(b) GSA may expedite screening by shortening the period of utilization screening for items individually or by FSC class which have a history of little demand. GSA may extend the screening period to adequately screen large generations or specialized items. The appropriate GSA regional office will coordinate surplus release date changes with the reporting activity to minimize impact on the utilization and disposal process. Agencies may not shorten or lengthen screening periods on their own.

p. Section 101-43.311-2 is amended by revising paragraph (a) and removing paragraph (c) to read as follows:

§101-43.311-2 Nonreportable property.

(a) Nonreportable property shall become surplus when it has been made available by the holding agency for Federal use for a minimum of 21 calendar days from the date made available for screening to Federal agencies, unless determined otherwise by GSA, and has not been selected for transfer by another Federal agency. Holding agencies shall annotate property records with the date of the agency excess determination. Authorized Federal agency representatives may request and, with the approval of GSA, holding agencies will grant additional screening time not to exceed 30 calendar days, unless otherwise agreed upon by the holding agency and the GSA regional office concerned. GSA may shorten or lengthen the screening time.

* * * * *

q. Section 101-43.314 is amended by revising paragraph (b)(2)(iv) to read as follows:

§101-43.314 Use of excess personal property on grants.

* * * * *

(b) * * *

(2) * * *

(iv) Excess scientific equipment transferred pursuant to section 11(e) of the National Science Foundation Act of 1950, as amended (42 U.S.C. 1870(e)). GSA will consider items of personal property as scientific equipment for transfer without reimbursement to the National Science Foundation (NSF) for use by a project grantee when the property requested is within FSC groups 12 (Fire Control Equipment), 14 (Guided Missiles), 43 (Pumps and Compressors), 48 (Valves), 58 (Communication, Detection, and Coherent Radiation Equipment), 59 (Electrical and Electronic Equipment Components), 65 (Medical, Dental, and Veterinary Equipment and Supplies), 66 (Instruments and Laboratory Equipment), 67 (Photographic Equipment), 68 (Chemicals and Chemical Products), or 70 (General Purpose Information Processing Equipment (Including Firmware), Software, Supplies, and Support Equipment). GSA will give consideration to transfer without reimbursement of items of excess property in other FSC groups when NSF certifies the item requested is a component of or related to a piece of scientific equipment or is an otherwise difficult-to-acquire item needed for scientific research. Items of property determined by GSA to be common use or general purpose property, regardless of classification, shall not be transferred to NSF for use by a project grantee without reimbursement.

* * * * *

r. Section 101-43.4801 is amended by revising paragraphs (a) through (d) to read as follows:

§101-43.4801 Excess personal property reporting requirements.

(a) The table shown in paragraph (d) of this section shows the excess personal property Federal Supply Classification (FSC) groups and classes comprising reportable property. Property in these groups and classes must be reported to GSA when the following condition code and dollar threshold criteria are met:

(1) With the exception of aircraft, the condition code as defined in paragraph (e) of this section is salvage or better. Fixed-wing and rotary-wing aircraft, airframe structural components, and aircraft engines, as specified in paragraph (b) of this section, are reportable regardless of condition in accordance with §101-43.304-2.

(2) The unit cost, measured in acquisition dollars, is \$5,000 or more.

Federal Property Management Regulations

Ch. 101, Subch. H, App.

(b) With respect to aircraft and aircraft components and accessories:

(1) As indicated in the table in paragraph (d) of this section, line items in FSC classes 1510, 1520, 1560, 2810, 2840, or any class in FSC group 16 shall be reported. In agencies other than the Department of Defense, all line items in these classes shall be reported regardless of condition code when dollar criteria are met. For the Department of Defense, aircraft in FSC class 1510 which are in the Cargo/Transport, Observation, Anti-sub, Trainer, or Utility series, all aircraft in FSC class 1520, and line items in other classes which are components of these aircraft shall

be reported regardless of condition code when dollar criteria are met.

(2) Items in FSC classes 1510 and 1520 held by the Department of Defense or other agencies shall be reported to the General Services Administration (9FB), San Francisco, California 94102.

(c) All excess Government-owned information technology (IT) equipment and software, as defined in subpart 101-43.6, shall be disposed of in accordance with the provisions of that subpart.

(d) The following table shows FSC groups and classes which comprise reportable property:

FSC group	FSC class	Noun name
15	1510	Aircraft, fixed wing.
	1520	Aircraft, rotary wing.
	1560	Airframe, structural components.
16	All	Aircraft components and accessories.
18	All	Space vehicles.
19	All	Ships, small craft, pontoons, and floating docks (All but vessels over 1500 gross tons).
22	All	Railway equipment.
23	All	Ground effect vehicles, motor vehicles, trailers, and cycles.
24	All	Tractors.
28	2805	Gasoline, reciprocating engines, except aircraft.
	2810	Gasoline, reciprocating engines, aircraft.
	2815	Diesel engines and components.
	2840	Gas turbines and jet engines.
32	All	Woodworking machinery and equipment.
34	All	Metalworking machinery.
35	All	Service and trade equipment.
36	All	Special industry machinery (all but 3690 Specialized ammunition and ordinance machinery and related equipment).
37	All	Agricultural machinery and equipment.
38	All	Construction, mining excavating, and highway maintenance equipment.
39	All	Materials handling equipment.
42	All	Fire fighting, rescue, and safety equipment.
43	All	Pumps and compressors.
49	4910	Motor vehicle maintenance and repair shop specialized equipment.
	4920	Aircraft maintenance and repair shop specialized equipment.
	4930	Lubrication and fuel dispensing equipment.
	4935	Guided missile maintenance, repair, and checkout specialized equipment.
	4940	Miscellaneous maintenance, and repair shop specialized equipment.
	4960	Space vehicle maintenance, repair, and checkout specialized equipment.
54	All	Prefabricated structures and scaffolding.
61	All	Electric wire and power and distribution equipment.
66	All	Instruments and laboratory equipment.
71	All	Furniture.
73	All	Food preparation and serving equipment.

* * * * *

§ 101-43.4802 Regional office addresses and assigned areas.

s. Section 101-43.4802 is revised to read as follows:

Region and office address	Regional areas
National Capital Region, 470 L'Enfant Plaza East, SW., Suite 8100, Washington, DC 20407.	District of Columbia, Maryland (Prince Georges and Montgomery Counties only). Virginia (Prince William, Loudoun, Fairfax and Arlington Counties, and the cities of Alexandria, Fairfax, Falls Church, Manassas, and Manassas Park only).
1—General Services Administration, O'Neill Federal Office Building, Massachusetts, 10 Causeway Street, Boston, MA 02222.	Connecticut, Maine, New Hampshire, Rhode Island, Vermont.
2—General Services Administration, Jacob K. Javits Federal Building, 26 Federal Plaza, New York, NY 10278.	New Jersey, New York, Commonwealth of Puerto Rico, Virgin Islands.

Region and office address	Regional areas
3—General Services Administration, Wannamaker Building, 100 Penn Square East, Philadelphia, PA 19107.	Delaware, Maryland, Pennsylvania, Virginia, West Virginia.
4—General Services Administration, 410 West Peachtree Street, Atlanta, GA 30365.	Alabama, Florida, Georgia, Kentucky, Mississippi, North Carolina, South Carolina, Tennessee.
5—General Services Administration, 230 South Dearborn Street, Chicago, IL 60604.	Illinois, Indiana, Michigan, Minnesota, Ohio, Wisconsin.
6—General Services Administration, 4400 College Blvd., Suite 175, Overland Park, KS 66211.	Iowa, Kansas, Missouri, Nebraska.
7—General Services Administration, 819 Taylor Street, Fort Worth, TX 76102.	Arkansas, Louisiana, New Mexico, Oklahoma, Texas.
8—General Services Administration, Building 41, Denver Federal Center, Denver, CO 80225.	Colorado, Montana, North Dakota, South Dakota, Utah, Wyoming.
9—General Services Administration, 450 Golden Gate Avenue, San Francisco, CA 94102.	Arizona, California, Hawaii, Nevada, Pacific Ocean Areas.
10—General Services Administration, 400 15th Street, SW., Auburn, WA 98001.	Alaska, Idaho, Oregon, Washington.

t. Section 101-44.109 is amended by revising paragraphs (a) and (b) to read as follows:
§ 101-44.109 Donation screening period.

(a) Unless otherwise directed by GSA, a period of 21 calendar days following the surplus release date (see § 101-43.001-32) shall be provided to set aside surplus reportable and nonreportable property determined to be usable and necessary for donation purposes in accordance with the provisions of subparts 101-44.2, 101-44.4, and 101-44.5. Reportable surplus property will be set aside for donation when a Standard Form 123, with an informational copy to the holding activity, is submitted to a GSA regional office for approval within the donation screening period. Nonreportable property will be set aside for donation upon notification to a holding activity within the donation screening period by a responsible Federal official, a State agency representative, or an authorized donee representative that the property is usable and necessary for donation purposes.

(b) During the prescribed 21-day donation screening period, Standard Forms 123 will be processed by GSA regional offices in the following sequence:

(1) Department of Defense personal property which is reportable surplus will be reserved for public airport donation during the first 5 calendar days of the donation screening period and for service educational activities (SEA's) during the next 5 calendar days. During the remaining portion of the donation screening period, the property will be available on an equal basis to all applicants.

(2) Executive agency personal property, other than personal property of the Department of Defense, which is reportable surplus will be reserved for public airport donation during the first 5 calendar days of the donation screening period. During the remaining portion of the donation screening period, the property will be available on an equal basis to all applicants. This property is not available for donation to SEA's.

(3) All executive agency personal property which is nonreportable surplus will be made

available for donation on an equal basis to all applicants. SEAs are not eligible for donation of nonreportable surplus of executive agencies other than the Department of Defense.

* * * * *

u. Section 101-45.303 is amended by revising paragraphs (a) and (b) to read as follows:
§ 101-45.303 Reporting property for sale.

* * * * *

(a) Reportable surplus. Reportable surplus, if not donated, will be programmed for sale by the GSA regional office unless the holding agency indicates on their reports of excess personal property that they elect to sell their own property.

(b) Nonreportable surplus. Nonreportable surplus, if not donated, shall be reported to the appropriate GSA regional office on Standard Form 126, Report of Personal Property for Sale (illustrated at § 101-45.4901-126) if GSA is to sell the property. Standard Form 126A, Report of Personal Property for Sale (Continuation Sheet), shall be added if additional pages are required. Standard Forms 126 and 126A are stocked as five-part carbon interleaved forms and may be obtained by submitting a requisition in FEDSTRIP/MILSTRIP format to the GSA regional office providing support to the requesting activity.

8. *Effect on other directives.* This regulation modifies portions of regulations appearing at parts 101-42 through 101-45 that pertains to the reporting and screening process for property determined to be excess to an agency's needs.

Dated: September 5, 1996

David J. Barram,
Acting Administrator of General Services

Federal Property Management Regulations

Ch. 101, Subch. H, App.

General Services Administration

Washington, DC 20405

FEDERAL PROPERTY MANAGEMENT
REGULATIONS, TEMPORARY REGULATION H-30

To: Heads of Federal agencies

Subject: Donation of Federal surplus personal
property to nonprofit providers of assistance
to impoverished families and individuals

1. Purpose. This regulation expands eligi-
bility for the Federal surplus personal prop-
erty donation program to include nonprofit
organizations that provide food, clothing,
housing, or other assistance to families or
individuals with incomes below the poverty
line.

2. Effective date. This regulation is effective
upon publication in the FEDERAL REGISTER.

3. Expiration date. This regulation expires 2
years from the effective date. Prior to the
expiration date, this regulation will be codi-
fied in a new regulation named the Federal
Property and Administrative Services Regu-
lation (FPASR). The FPASR will replace the
Federal Property Management Regulations
and appear in 41 CFR Chapter 102.

4. Applicability. The provisions of this regu-
lation apply to all State agencies as defined
in FPMR 101-44.001-14. Such agencies must
follow this regulation and other guidelines in
FPMR 101-44.207 when determining an appli-
cant's eligibility as a nonprofit provider.

5. Background. Section 1 of Public Law 105-
50, signed by the President on October 6, 1997,
amended section 203(j)(3)(B) of the Federal
Property and Administrative Services Act of
1949, as amended, to add nonprofit organiza-
tions that provide assistance to the impover-
ished to the list of organizations eligible to
acquire surplus personal property for edu-
cational or public health purposes. Legisla-
tive history indicates the intent of this sec-
tion was to provide surplus property eligi-
bility to charitable organizations such as
food banks, Habitat for Humanity, and the
Salvation Army. See 143 Cong. Rec. H1941
(daily ed. April 29, 1997) (statement of Rep.
Horn). These groups provide goods and ser-
vices that contribute to the educational
growth or general health and well-being of
individuals and families below the poverty
line. FPMR 101-44.207 is amended to make
such providers eligible for Federal surplus
personal property donations.

6. Explanation of changes. Section 101-44.207
is amended by adding paragraph (a)(18.2) and
revising paragraph (c) to read as follows:

§ 101-44.207 Eligibility.

* * * * *

(a) * * *

(18.2) Provider of assistance to impoverished
families and individuals means a public or pri-
vate, nonprofit tax-exempt organization

whose primary function is to provide money,
goods, or services to families or individuals
whose annual incomes are below the poverty
line (as defined in section 673 of the Commu-
nity Services Block Grant Act) (42 U.S.C.
9902). Providers include food banks, self-help
housing groups, and organizations providing
services such as the following: Health care;
medical transportation; scholarships and tui-
tion assistance; tutoring and literacy in-
struction; job training and placement; em-
ployment counseling; child care assistance;
meals or other nutritional support; clothing
distribution; home construction or repairs;
utility or rental assistance; and legal coun-
sel.

* * * * *

(c) Eligibility of nonprofit tax-exempt activi-
ties. Surplus personal property may be do-
nated through the State agency to nonprofit
tax-exempt activities, as defined in this sec-
tion, within the State, such as:

- (1) Medical institutions;
(2) Hospitals;
(3) Clinics;
(4) Health centers;
(5) Providers of assistance to homeless in-
dividuals;
(6) Providers of assistance to impoverished
families and individuals;
(7) Schools;
(8) Colleges;
(9) Universities;
(10) Schools for the mentally retarded;
(11) Schools for the physically handi-
capped;
(12) Child care centers;
(13) Radio and television stations licensed
by the Federal Communications Commission
as educational radio or educational tele-
vision stations;
(14) Museums attended by the public;
(15) Libraries, serving free all residents of
a community, district, State or region; or
(16) Organizations or institutions that re-
ceive funds appropriated for programs for
older individuals under the Older Americans
Act of 1965, as amended, under title IV and
title XX of the Social Security Act, or under
titles VIII and X of the Economic Oppor-
tunity Act of 1964 and the Community Ser-
vices Block Grant Act. Programs for older in-
dividuals include services that are necessary
for the general welfare of older individuals,
such as social services, transportation ser-
vices, nutrition services, legal services, and
multipurpose senior centers.

7. Effect on other directives. This regulation
modifies the regulations appearing in para-
graphs (a) and (c) of FPMR 101-44.207.

Dated: February 5, 1998

Thurman M. Davis, Sr.,
Acting Administrator of General Services